

This International Student Edition is for use outside of the U.S.

William J. Stevenson

Operations Management *14e*



Mc
Graw
Hill

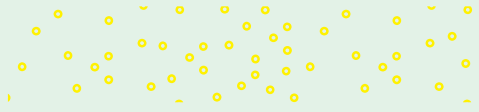

Operations Management

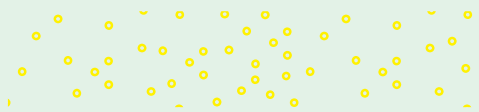

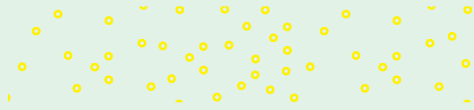

Operations Management

FOURTEENTH EDITION

William J. Stevenson

*Saunders College of Business
Rochester Institute of Technology*

**Mc
Graw
Hill**

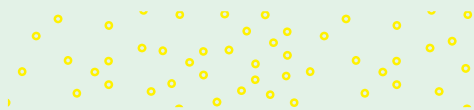

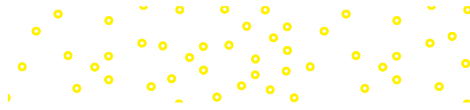

OPERATIONS MANAGEMENT

Published by McGraw-Hill Education, 2 Penn Plaza, New York, NY 10121. Copyright © 2021 by McGraw-Hill Education. All rights reserved. Printed in the United States of America. No part of this publication may be reproduced or distributed in any form or by any means, or stored in a database or retrieval system, without the prior written consent of McGraw-Hill Education, including, but not limited to, in any network or other electronic storage or transmission, or broadcast for distance learning.

Some ancillaries, including electronic and print components, may not be available to customers outside the United States.

This book is printed on acid-free paper.

1 2 3 4 5 6 7 8 9 LWI 24 23 22 21 20

ISBN 978-1260-57571-2

MHID 1-260-57571-3

Cover Image: *Daniel Prudek/Shutterstock*

All credits appearing on page or at the end of the book are considered to be an extension of the copyright page.

The Internet addresses listed in the text were accurate at the time of publication. The inclusion of a website does not indicate an endorsement by the authors or McGraw-Hill Education, and McGraw-Hill Education does not guarantee the accuracy of the information presented at these sites.

mheducation.com/highered

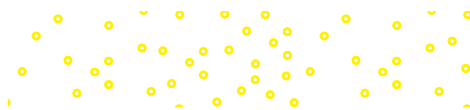



The McGraw-Hill Series in Operations and Decision Sciences

Supply Chain Management

Benton

Purchasing and Supply Chain Management
Third Edition

Bowersox, Closs, Cooper, and Bowersox
Supply Chain Logistics Management
Fifth Edition

Burt, Petcavage, and Pinkerton
Supply Management
Eighth Edition

Johnson
Purchasing and Supply Management
Sixteenth Edition

Simchi-Levi, Kaminsky, and Simchi-Levi
**Designing and Managing the Supply
Chain: Concepts, Strategies, Case Studies**
Third Edition

Stock and Manrodt
Supply Chain Management

Project Management

Brown and Hyer
**Managing Projects: A Team-Based
Approach**

Larson
**Project Management: The
Managerial Process**
Eighth Edition

Service Operations Management

Bordoloi, Fitzsimmons, and Fitzsimmons
**Service Management: Operations,
Strategy, Information Technology**
Ninth Edition

Management Science

Hillier and Hillier
**Introduction to Management Science:
A Modeling and Case Studies Approach
with Spreadsheets**
Sixth Edition

Business Research Methods

Schindler

Business Research Methods
Thirteenth Edition

Business Forecasting

Keating and Wilson
Forecasting and Predictive Analytics
Seventh Edition

Business Systems Dynamics

Sterman
**Business Dynamics: Systems Thinking
and Modeling for Complex World**

Operations Management

Cachon and Terwiesch
Operations Management
Second Edition

Cachon and Terwiesch
**Matching Supply with Demand: An
Introduction to Operations Management**
Fourth Edition

Jacobs and Chase
**Operations and Supply Chain
Management: The Core**
Fifth Edition

Jacobs and Chase
Operations and Supply Chain Management
Sixteenth Edition

Schroeder and Goldstein
**Operations Management: Contemporary
Concepts and Cases**
Eighth Edition

Stevenson
Operations Management
Fourteenth Edition

Swink, Melnyk, and Hartley
**Managing Operations Across the
Supply Chain**
Fourth Edition

Business Statistics

Bowerman, Drougas, Duckworth,
Froelich, Hummel, Moninger,
and Schur

**Business Statistics and Analytics
in Practice**
Ninth Edition

Doane and Seward
**Applied Statistics in Business and
Economics**
Sixth Edition

Doane and Seward
**Essential Statistics in Business and
Economics**
Third Edition

Lind, Marchal, and Wathen
**Basic Statistics for Business and
Economics**
Ninth Edition

Lind, Marchal, and Wathen
**Statistical Techniques in Business
and Economics**
Eighteenth Edition

Jaggia and Kelly
**Business Statistics: Communicating
with Numbers**
Third Edition

Jaggia and Kelly
**Essentials of Business Statistics:
Communicating with Numbers**
Second Edition

McGuckian
**Connect Master: Business
Statistics**

Business Analytics

Jaggia, Kelly, Lertwachara,
and Chen
**Business Analytics: Communicating
with Numbers**

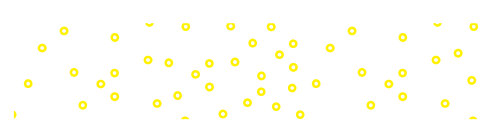

Preface

The material in this book is intended as an introduction to the field of operations management. The topics covered include both strategic issues and practical applications. Among the topics are forecasting, product and service design, capacity planning, management of quality and quality control, inventory management, scheduling, supply chain management, and project management.

My purpose in revising this book continues to be to provide a clear presentation of the concepts, tools, and applications of the field of operations management. Operations management is evolving and growing, and I have found updating and integrating new material to be both rewarding and challenging, particularly due to the plethora of new developments in the field, while facing the practical limits on the length of the book.

This text offers a comprehensive and flexible amount of content that can be selected as appropriate for different courses and formats, including undergraduate, graduate, and executive education.

This allows instructors to select the chapters, or portions of chapters, that are most relevant for their purposes. That flexibility also extends to the choice of relative weighting of the qualitative or quantitative aspects of the material, and the order in which chapters are covered, because chapters do not depend on sequence. For example, some instructors cover project management early, others cover quality or lean early, and so on.

As in previous editions, there are major pedagogical features designed to help students learn and understand the material. This section describes the key features of the book, the chapter elements, the supplements that are available for teaching the course, highlights of the fourteenth edition, and suggested applications for classroom instruction. By providing this support, it is our hope that instructors and students will have the tools to make this learning experience a rewarding one.

What's New in This Edition

In many places, content has been rewritten or added to improve clarity, shorten wording, or update information. New material has been added on supply chains, and other topics. Some problems are new, and others have been revised. Many new readings and new photos have been added.

Some of the class preparation exercises have been revised. The purpose of these exercises is to introduce students to the subject matter before class in order to enhance classroom

learning. They have proved to be very popular with students, both as an introduction to new material and for study purposes. These exercises are available in the Instructor's Resource Manual. Special thanks to Linda Brooks for her help in developing the exercises.

Acknowledgments

I want to thank the many contributors to this edition. Reviewers and adopters of the text have provided a “continuously improving” wealth of ideas and suggestions. It is encouraging to me as an author. I hope all reviewers and readers will know their suggestions were valuable, were carefully considered, and are sincerely appreciated. The list includes post-publication reviewers.

Jenyi Chen	Cleveland State University
Eric Cosnoski	Lehigh University
Mark Gershon	Temple University
Narges Kasiri	Ithaca College
Nancy Lambe	University of South Alabama
Anita Lee-Post	University of Kentucky
Behnam Nakhai	Millersville University of Pennsylvania
Rosa Oppenheim	Rutgers Business School
Marilyn Preston	Indiana University Southeast
Avanti Sethi	University of Texas at Dallas
John T. Simon	Governors State University
Lisa Spencer	California State University, Fresno
Nabil Tamimi	University of Scranton
Oya Tukel	Cleveland State University
Theresa Wells	University of Wisconsin-Eau Claire
Heath Wilken	University of Northern Iowa

Additional thanks to the instructors who have contributed extra material for this edition, including accuracy checkers: Ronny Richardson, Kennesaw State University and Gary Black, University of Southern Indiana; Solutions and SmartBook: Tracie Lee, Boise State University; PowerPoint Presentations: Avanti Sethi, University of Texas-Dallas; Test Bank: Leslie Sukup, Ferris State University.

Special thanks goes out to Lisa Spencer, California State University-Fresno, for her help with additional readings and examples.

Finally, I would like to thank all the people at McGraw-Hill for their efforts and support. It is always a pleasure to work with such a professional and competent group of people. Special thanks go to Noelle Bathurst, Portfolio Manager; Michele Janicek, Lead Product Developer; Fran Simon and Katie Ward, Product Developers; Jamie Koch, Assessment Content Project Manager; Sandy Ludovissy, Buyer; Matt Diamond, Designer; Jacob Sullivan, Content Licensing Specialist; Harper Christopher, Executive Marketing Manager; and many others who worked behind the scenes.

I would also like to thank the many reviewers of previous editions for their contributions: Vikas Agrawal, Fayetteville State University; Bahram Alidaee, University of Mississippi; Ardavan Asef-Faziri, California State University at Northridge; Prabir Bagchi, George Washington State University; Gordon F. Bagot, California State University at Los Angeles; Ravi Behara, Florida Atlantic University; Michael Bendixen, Nova Southeastern; Ednilson Bernardes, Georgia Southern University; Prashanth N. Bharadwaj, Indiana University of Pennsylvania; Greg Bier, University of Missouri at Columbia; Joseph Biggs, Cal Poly State University; Kimball Bullington, Middle Tennessee State University; Alan Cannon, University of Texas at Arlington; Injazz Chen, Cleveland State University; Alan Chow, University of Southern Alabama at Mobile; Chrwan-Jyh, Oklahoma State University; Chen Chung, University of Kentucky; Robert Clark, Stony Brook University; Loretta Cochran, Arkansas Tech University; Lewis Cooper-smith, Rider University; Richard Crandall, Appalachian State University; Dinesh Dave, Appalachian State University; Scott Dellana, East Carolina University; Kathy Dhanda, DePaul University; Xin Ding, University of Utah; Ellen Dumond, California State University at Fullerton; Richard Ehrhardt, University of North Carolina at Greensboro; Kurt Engemann, Iona College; Diane Ervin, DeVry University; Farzaneh Fazel, Illinois State University; Wanda Fennell, University of Mississippi at Hattiesburg; Joy Field, Boston College; Warren Fisher, Stephen F. Austin State University; Lillian Fok, University of New Orleans; Charles Foley, Columbus State Community College; Matthew W. Ford, Northern Kentucky University; Phillip C. Fry, Boise State University; Charles A. Gates Jr., Aurora University; Tom Gattiker, Boise State University; Damodar Golhar, Western Michigan University; Robert Graham, Jacksonville State University; Angappa Gunasekaran, University of Massachusetts at Dartmouth; Haresh Gurnani, University of Miami; Terry Harrison, Penn State University; Vishwanath Hegde, California State University at East Bay; Craig Hill, Georgia State University; Jim Ho, University of Illinois at Chicago; Seong Hyun Nam, University of North Dakota; Jonatan Jelen, Mercy College;

Prafulla Joglekar, LaSalle University; Vijay Kannan, Utah State University; Sunder Kekre, Carnegie-Mellon University; Jim Keyes, University of Wisconsin at Stout; Seung-Lae Kim, Drexel University; Beate Klingenberg, Marist College; John Kros, East Carolina University; Vinod Lall, Minnesota State University at Moorhead; Kenneth Lawrence, New Jersey Institute of Technology; Jooh Lee, Rowan University; Anita Lee-Post, University of Kentucky; Karen Lewis, University of Mississippi; Bingguang Li, Albany State University; Cheng Li, California State University at Los Angeles; Maureen P. Lojo, California State University at Sacramento; F. Victor Lu, St. John's University; Janet Lyons, Utah State University; James Maddox, Friends University; Gita Mathur, San Jose State University; Mark McComb, Mississippi College; George Mechling, Western Carolina University; Scott Metlen, University of Idaho; Douglas Micklich, Illinois State University; Ajay Mishra, SUNY at Binghamton; Scott S. Morris, Southern Nazarene University; Philip F. Musa, University of Alabama at Birmingham; Roy Nersesian, Monmouth University; Jeffrey Ohlmann, University of Iowa at Iowa City; John Olson, University of St. Thomas; Ozgur Ozluk, San Francisco State University; Kenneth Paetsch, Cleveland State University; Taeho Park, San Jose State University; Allison Pearson, Mississippi State University; Patrick Penfield, Syracuse University; Steve Peng, California State University at Hayward; Richard Peschke, Minnesota State University at Moorhead; Andru Peters, San Jose State University; Charles Phillips, Mississippi State University; Frank Pianki, Anderson University; Sharma Pillutla, Towson University; Zinovy Radovitsky, California State University at Hayward; Stephen A. Raper, University of Missouri at Rolla; Pedro Reyes, Baylor University; Buddhadev Roychoudhury, Minnesota State University at Mankato; Narendra Rustagi, Howard University; Herb Schiller, Stony Brook University; Dean T. Scott, DeVry University; Scott J. Seipel, Middle Tennessee State University; Raj Selladurai, Indiana University; Kaushic Sengupta, Hofstra University; Kenneth Shaw, Oregon State University; Dooyoung Shin, Minnesota State University at Mankato; Michael Shurden, Lander University; Raymond E. Simko, Myers University; John Simon, Governors State University; Jake Simons, Georgia Southern University; Charles Smith, Virginia Commonwealth University; Kenneth Solheim, DeVry University; Young Son, Bernard M. Baruch College; Victor Sower, Sam Houston State University; Jeremy Stafford, University of North Alabama; Donna Stewart, University of Wisconsin at Stout; Dothang Truong, Fayetteville State University; Mike Umble, Baylor University; Javad Varzandeh, California State University at San Bernardino; Timothy Vaughan, University of Wisconsin at Eau Claire; Emre Veral,

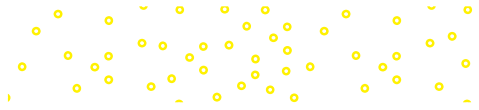

Baruch College; Mark Vroblefski, University of Arizona; Geoff Willis, University of Central Oklahoma; Pamela Zelbst, Gustavo Vulcano, New York University; Walter Wallace, Sam Houston State University; Jiawei Zhang, NYU; Zhenying Zhao, University of Maryland; Yong-Pin Zhou, University of Washington; Georgia State University; James Walters, Ball State University; John Wang, Montclair State University; Tekle Wanorie, Northwest Missouri State University; Jerry Wei, University of Notre Dame; Michael Whittenberg, University of Texas;

William J. Stevenson

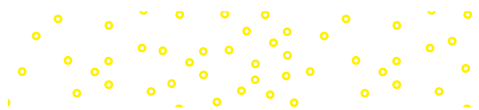

Walkthrough

MAJOR STUDY AND LEARNING FEATURES

A number of key features in this text have been specifically designed to help introductory students learn, understand, and apply operations concepts and problem-solving techniques.

Examples with Solutions

Throughout the text, wherever a quantitative or analytic technique is introduced, an example is included to illustrate the application of that technique. These are designed to be easy to follow.

Determining a Regression Equation

Sales of new houses and three-month lagged unemployment are shown in the following table. Determine if unemployment levels can be used to predict demand for new houses and, if so, derive a predictive equation.

Period	1	2	3	4	5	6	7	8	9	10	11
Units sold	20	41	17	35	25	31	38	50	15	19	14
Unemployment % (three-month lag)	7.2	4.0	7.3	5.5	6.8	6.0	5.4	3.6	8.4	7.0	9.0

EXAMPLE 8

excel
mhhe.com/stevenson14e

1. Plot the data to see if a *linear* model seems reasonable. In this case, a linear model seems appropriate *for the range of the data*.

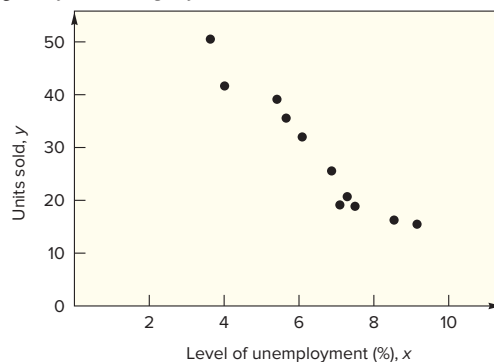

SOLUTION

2. Check the correlation coefficient to confirm that it is not close to zero using the web-site template, and then obtain the regression equation:

$$r = -.966$$

This is a fairly high negative correlation. The regression equation is

$$y = 71.85 - 6.91x$$

Note that the equation pertains only to unemployment levels in the range 3.6 to 9.0, because sample observations covered only that range.

Solved Problems

At the end of chapters and chapter supplements, “Solved Problems” are provided to illustrate problem solving and the core concepts in the chapter. These have been carefully prepared to help students understand the steps involved in solving different types of problems. The Excel logo indicates that a spreadsheet is available on the text’s website.

SOLVED PROBLEMS

Computing Productivity
A company that processes fruits and vegetables is able to produce 400 cases of canned peaches in one-half hour with four workers. What is labor productivity?

$$\text{Labor productivity} = \frac{\text{Quantity produced}}{\text{Labor hours}} = \frac{400 \text{ cases}}{4 \text{ workers} \times 1/2 \text{ hour/worker}} = 200 \text{ cases per labor hour}$$

Problem 1

mhhe.com/stevenson14e

Solution

Computing Multifactor Productivity
A wrapping-paper company produced 2,000 rolls of paper in one day. Labor cost was \$160, material cost was \$50, and overhead was \$320. Determine the multifactor productivity.

$$\text{Multifactor productivity} = \frac{\text{Quantity produced}}{\text{Labor cost} + \text{Material cost} + \text{Overhead}} = \frac{2,000 \text{ rolls}}{\$160 + \$50 + \$320} = 3.77 \text{ rolls per dollar input}$$

A variation of the multifactor productivity calculation incorporates the standard price in the numerator by multiplying the units by the standard price.

Problem 2

mhhe.com/stevenson14e

Solution

TABLE 16.5 Excel solution for Example 2a

Job Sequencing		Clear	FCFS	SPT	DD	CR	S/O				
<Back		Notes		Current Date: 23							
Job	Process. Time	Due Date	Remain Oper.	CR Sequence	Critical Ratio	Slack	S/O	Flow Time	Days Late		
A	2	7		3		5		2	0		
B	8	16		5		8		10	0		
C	4	4		1		0		14	10		
D	10	17		6		7		24	7		
E	5	15		4		10		29	14		
F	12	18		2		6		41	23		
Totals		41	0			36		120	54		

Method	FCFS
Average Flow Time	20.00
Average Tardiness	9.00
Average Number of Jobs	2.93

Days Late

A	B	C	D	E	F
---	---	---	---	---	---

See notes below.

Notes:

1. Enter Job Name, Processing Time, and Due Date for each job.
2. For the FCFS, SPT, and DD rules, simply press the appropriate button.
3. For the CR rule, perform the following BEFORE pressing the CR button:
 - a. Select job with lowest Critical Ratio
 - b. Schedule that job next by entering next sequence number (start with 1) in the CR Sequence column.
 - c. Add the processing time for that job to the current date.
 - d. Repeat steps a, b, and c until all jobs have been scheduled (i.e. the CR Sequence column is filled in).
 - e. Then press the CR button.
4. Fill in the Remaining Operations column and then press the S/O button.

Excel Spreadsheet Solutions

Where applicable, the examples and solved problems include screen shots of a spreadsheet solution.

CHAPTER ELEMENTS

Within each chapter, you will find the following elements that are designed to facilitate study and learning. All of these have been carefully developed over many editions and have proven to be successful.

Learning Objectives

Every chapter and supplement lists the learning objectives to achieve when studying the chapter material. The learning objectives are also included next to the specific material in the margins of the text.

4 Product and Service Design
CHAPTER

LEARNING OBJECTIVES

After completing this chapter, you should be able to:

- LO4.1 Explain the strategic importance of product and service design.
- LO4.2 Describe what product and service design does.
- LO4.3 Name the key questions of product and service design.
- LO4.4 Identify some reasons for design or redesign.
- LO4.5 List some of the main sources of design ideas.
- LO4.6 Discuss the importance of legal, ethical, and sustainability considerations in product and service design.
- LO4.7 Explain the purpose and goal of life-cycle assessment.
- LO4.8 Explain the phrase "the 3 Rs."
- LO4.9 Briefly describe the phases in product design and development.
- LO4.10 Discuss several key issues in product or service design.
- LO4.11 Discuss the two key issues in service design.
- LO4.12 List the characteristics of well-designed service systems.
- LO4.13 List some guidelines for successful service design.

CHAPTER OUTLINE

- 4.1 Introduction 140
 - What Does Product and Service Design Do? 140
 - Objectives of Product and Service Design 141
 - Key Questions 141
 - Reasons for Product or Service Design or Redesign 141
- 4.2 Idea Generation 142
- 4.3 Legal and Ethical Considerations 144
- 4.4 Human Factors 145
- 4.5 Cultural Factors 145
- 4.6 Global Product and Service Design 146
- 4.7 Environmental Factors: Sustainability 146
 - Cradle-to-Grave Assessment 146
 - End-of-Life Programs 147
 - The Three Rs: Reduce, Reuse, and Recycle 147
 - Reduce: Value Analysis 147
 - Reuse: Remanufacturing 148
 - Recycle 149
- 4.8 Other Design Considerations 151
 - Strategies for Product or Service Life Stages 151
 - Product Life Cycle Management 152
 - Degree of Standardization 153
 - Designing for Mass Customization 154
 - Reliability 156
 - Robust Design 157
 - Degree of Newness 158
 - Quality Function Deployment 158
 - The Kano Model 160
- 4.9 Phases in Product Design and Development 162
- 4.10 Designing for Production 163
 - Concurrent Engineering 163
 - Computer-Aided Design (CAD) 164
 - Production Requirements 165
 - Component Commonality 165
- Service Blueprinting 168
- Characteristics of Well-Designed Service Systems 168
- Challenges of Service Design 169
- Guidelines for Successful Service Design 169
- 4.12 Operations Strategy 170
 - Operations Tour: High Acres Landfill 174
 - Chapter Supplement: Reliability 176

Opening Vignettes

The essence of a business organization is the products and services it offers, and every aspect of the organization and its supply chain are structured around those products and services. Organizations that have well-designed products or services are more likely to realize their goals than those with poorly designed products or services. Hence, organizations have a strategic interest in product and service design. Product or service design should be closely tied to an organization's strategy. It is a major factor in cost, quality, time-to-market, customer satisfaction, and competitive advantage. Consequently, marketing, finance, operations, accounting, IT, and HR need to be involved. Demand forecasts and projected costs are important, as is the expected impact on the supply chain. It is significant to note that an important cause of operations failures can be traced to faulty design. Designs that have not been well thought out, or are incorrectly implemented, or instructions for assembly or usage that are wrong or unclear, can be the cause of product and service failures, leading to lawsuits, injuries and deaths, product recalls, and damaged reputations.

continued

Chapter Outlines

Every chapter and supplement includes an outline of the topics covered.

Opening Vignettes

Each chapter opens with an introduction to the important operations topics covered in the chapter. This enables students to see the relevance of operations management in order to actively engage in learning the material.

Figures and Photos

The text includes photographs and graphic illustrations to support student learning and provide interest and motivation. Approximately 100 carefully selected photos highlight the 14th edition. The photos illustrate applications of operations and supply chain concepts in many successful companies. More than 400 graphic illustrations, more than any other text in the field, are included and all are color coded with pedagogical consistency to assist students in understanding concepts.

FIGURE 6.1
Process selection and capacity planning influence system design

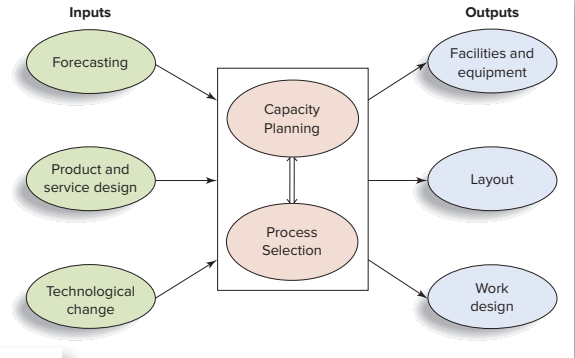

A major key to Apple's continued success is its ability to keep pushing the boundaries of innovation. Apple has demonstrated how to create growth by dreaming up products so new and ingenious that they have upended one industry after another.



5.12 OPERATIONS STRATEGY

The strategic implications of capacity decisions can be enormous, impacting all areas of the organization. From an operations management standpoint, capacity decisions establish a set of conditions within which operations will be required to function. Hence, it is extremely important to include input from operations management people in making capacity decisions.

Flexibility can be a key issue in capacity decisions, although flexibility is not always an option, particularly in capital-intensive industries. However, where possible, flexibility allows an organization to be agile—that is, responsive to changes in the marketplace. Also, it reduces to a certain extent the dependence on long-range forecasts to accurately predict demand. And flexibility makes it easier for organizations to take advantage of technological and other innovations. Maintaining excess capacity (a capacity cushion) may provide a degree of flexibility, albeit at added cost.

Some organizations use a strategy of maintaining a capacity cushion for the purpose of blocking entry into the market by new competitors. The excess capacity enables them to produce at costs lower than what new competitors can. However, such a strategy means higher-than-necessary unit costs, and it makes it more difficult to cut back if demand slows, or to shift to new product or service offerings.

Efficiency improvements and utilization improvements can provide capacity increases. Such improvements can be achieved by streamlining operations and reducing waste. The chapter on lean operations describes ways for achieving those improvements.

Bottleneck management can be a way to increase effective capacity, by scheduling non-bottleneck operations to achieve maximum utilization of bottleneck operations.

In cases where capacity expansion will be undertaken, there are two strategies for determining the timing and degree of capacity expansion. One is the *expand-early* strategy (i.e., before demand materializes). The intent might be to achieve economies of scale, to expand market share, or to preempt competitors from expanding. The risks of this strategy include an oversupply that would drive prices down, and underutilized equipment that would result in higher unit costs.

The other approach is the *wait-and-see* strategy (i.e., until demand materializes, perhaps incrementally). Its advantages are that it allows a company to

Operations Strategies

An Operations Strategy section is included at the end of most chapters. These sections discuss how the chapters' concepts can be applied and how they impact the operations of a company.

Readings

Readings highlight important real-world applications, provide examples of production/operations issues, and offer further elaboration of the text material. They also provide a basis for classroom discussion and generate interest in the subject matter. Many of the end-of-chapter readings include assignment questions.

READING



DUTCH BOY BRUSHES UP ITS PAINTS

Sherwin-Williams' Dutch Boy Group put a revolutionary spin on paint cans with its innovative square-shaped Twist & Pour™ paint-delivery container for the Dirt Fighter interior latex paint line. The four-piece square container could be the first major change in how house paint is packaged in decades. Lightweight but sturdy, the Twist & Pour "bucket" is packed with so many conveniences, it is next to impossible to mess up a painting project.

Winning Best of Show in an AmeriStar packaging competition sponsored by the Institute of Packaging Professionals, the exclusive, all-plastic paint container stands almost 7½ in. tall and holds 126 oz., a bit less than 1 gal. Rust-resistant and moisture-resistant, the plastic bucket gives users a new way to mix, brush, and store paint.

A hollow handle on one side makes it comfortable to pour and carry. A convenient, snap-in pour spout neatly pours paint into a tray with no dripping but can be removed if desired, to allow a wide brush to be dipped into the 5¼-in.-diameter mouth. Capping the container is a large, twist-off lid that requires no tools to open or close. Molded with two lugs for a snug-finger-tight closing, the threaded cap provides a tight seal to extend the shelf life of unused paint.

While the lid requires no tools to access, the snap-off carry bail is assembled on the container in a "locked-down position" and can be pulled up after purchase for toting or hanging on a ladder. Large, nearly 4½-inch-tall label panels allow glossy front and back labels printed and UV-coated to wrap around the can's rounded corners, for an impressive display.

Jim MacDonald, co-designer of the Twist & Pour and a packaging engineer at Cleveland-based Sherwin-Williams, tells *Packaging Digest* that the space-efficient, square shape is easier to ship and easier to stack in stores. It can also be nested, courtesy of a recess



Jerry Simon

in the bottom that mates with the lid's top ring. "The new design allows for one additional shelf facing on an eight-foot rack or shelf area."

The labels are applied automatically, quite a feat, considering their complexity, size, and the hollow handle they likely encounter during application. MacDonald admits, "Label application was a challenge. We had to modify the bottle several times to accommodate the labeling machinery available."

Source: "Dutch Boy Brushes Up Its Paints," *Packaging Digest*, October 2002. Copyright ©2002 Reed Business Information. Used with permission.

END-OF-CHAPTER RESOURCES

For student study and review, the following items are provided at the end of each chapter or chapter supplement.

associative model, 80	judgmental forecasts, 80	regression, 98
bias, 109	least squares line, 99	seasonality, 82
centered moving average, 96	linear trend equation, 89	seasonal relative, 94
control chart, 107	mean absolute deviation (MAD), 106	seasonal variations, 93
correlation, 102	mean absolute percent error (MAPE), 106	standard error of estimate, 100
cycle, 82	mean squared error (MSE), 106	time series, 82
Delphi method, 81	moving average, 84	time-series forecasts, 80
error, 105	naive forecast, 82	tracking signal, 109
exponential smoothing, 87	predictor variables, 98	trend, 82
focus forecasting, 88		trend-adjusted exponential smoothing, 92
forecast, 76		

KEY TERMS

Summaries and Key Points

Chapters contain summaries that provide an overview of the material covered, and the key points of the chapter are emphasized in a separate section.

Key Terms

Key terms are highlighted in the text and then repeated in the margin with brief definitions for emphasis. They are listed at the end of each chapter (along with page references) to aid in reviewing.

Taking Stock and Critical Thinking Exercises

These activities encourage analytical thinking and help broaden conceptual understanding. A question related to ethics is included in the Critical Thinking Exercises.

This item appears at the end of each chapter. It is intended to focus your attention on three key issues for business organizations in general, and operations management in particular. Those issues are trade-off decisions, collaboration among various functional areas of the organization, and the impact of technology. You will see three or more questions relating to these issues. Here is the first set of questions:

1. What are trade-offs? Why is careful consideration of trade-offs important in decision making?
2. Why is it important for the various functional areas of a business organization to collaborate?
3. In what general ways does technology have an impact on operations management decision making?

TAKING STOCK

This item also will appear in every chapter. It allows you to critically apply information you learned in the chapter to a practical situation. Here is the first set of exercises:

1. Many organizations offer a combination of goods and services to their customers. As you learned in this chapter, there are some key differences between the production of goods and the delivery of services. What are the implications of these differences relative to managing operations?
2. Why is it important to match supply and demand? If a manager believes that supply and demand will not be equal, what actions could the manager take to increase the probability of achieving a match?
3. One way that organizations compete is through technological innovation. However, there can be downsides for both the organization and the consumer. Explain.

CRITICAL THINKING EXERCISES

Discussion and Review Questions

Each chapter and each supplement have a list of discussion and review questions. These precede the problem sets and are intended to serve as a student self-review or as class discussion starters.

Problem Sets

Each chapter includes a set of problems for assignment. The problems have been refined over many editions and are intended to be challenging but doable for students. Short answers to most of the problems are included in Appendix A so students can check their understanding and see immediately how they are progressing.

1. Determine the utilization and efficiency for each of the following situations.
 - a. A loan processing operation that processes an average of 7 loans per day. The operation has a design capacity of 10 loans per day and an effective capacity of 8 loans per day.
 - b. A furnace repair team that services an average of four furnaces a day if the design capacity is six furnaces a day and the effective capacity is five furnaces a day.
 - c. Would you say that systems that have higher efficiency ratios than other systems will always have higher utilization ratios than those other systems? Explain.
2. In a job shop, effective capacity is only 50 percent of design capacity, and actual output is 80 percent of effective output. What design capacity would be needed to achieve an actual output of eight jobs per week?

PROBLEMS

Operations Tours

These provide a simple “walkthrough” of an operation for students, describing the company, its product or service, and its process of managing operations. Companies featured include Wegmans Food Markets, Morton Salt, Stickley Furniture, and Boeing.

OPERATIONS TOUR



STICKLEY FURNITURE

Introduction

www.stickley.com

L. & J.G. Stickley was founded in 1900 by brothers Leopold and George Stickley. Located just outside of Syracuse, New York, the company is a producer of fine cherry, white oak, and mahogany furniture. In the 1980s, the company reintroduced the company's original line of mission oak furniture, which now accounts for nearly 50 percent of the company's sales.

Over the years, the company experienced both good and bad times, and at one point it employed over 200 people. However, by the early 1970s, the business was in disarray; there were only about 20 full-time employees, and the company was on the brink of bankruptcy. The present owners bought the ailing firm in 1974, and under their leadership, the company has prospered and grown, and now has 1,350 employees. Stickley has five retail showrooms

in New York State, two in Connecticut, one in North Carolina, and its furniture is sold nationally by some 120 dealers.

Production

The production facility is a large, rectangular building with a 30-foot ceiling. Furniture making is labor intensive, although saws, sanders, and other equipment are very much a part of the process. In fact, electric costs average about \$60,000 a month. The company has its own tool room where cutting tools are sharpened, and replacement parts are produced as needed.

Worker skills range from low-skilled material handlers to highly skilled craftsmen. For example, seven master cabinet makers handle customized orders.

The process (see figure below) begins with various sawing operations where large boards received from the lumber mills are cut into smaller sizes. The company recently purchased a

CASE



PROMOTIONAL NOVELTIES

Promotional Novelties provides a wide range of novelty items for its corporate customers. It has just received an order for 20,000 toy tractor-trailers that will be sold by a regional filling station company as part of a holiday promotion. The order is to be shipped at the beginning of week 8. The tree diagram shows the various components of the trucks.

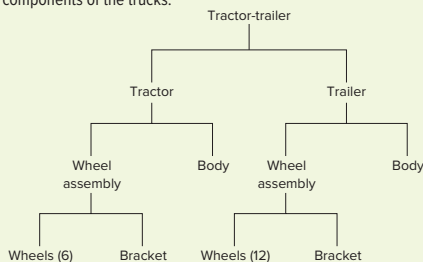

The company can complete final assembly of the trailers at the rate of 10,000 a week. The tractor and trailer are purchased; lead time is three weeks. The wheel manager's main concern.

The company has a sufficient supply of brackets. Assembly time is one week each for tractors, trailers, and wheel assemblies. However, the wheel department can only assemble wheels at the rate of 100,000 a week. The manager must use the wheel department to full capacity, starting at the beginning of the schedule, and order additional wheels from the supplier as needed. Ordered wheels come in sets of 6,400. The lead time for delivery from the supplier is expected to be three weeks. Use lot-for-lot ordering for all items except purchased wheels.

Questions

1. How many wheel sets should the manager order?
2. When should the wheel sets be ordered?

Cases

The text includes short cases. The cases were selected to provide a broader, more integrated thinking opportunity for students without taking a full case approach.

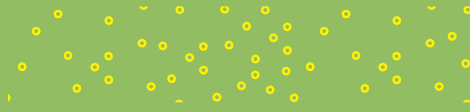

INSTRUCTOR RESOURCES

Available within Connect, instructors have access to teaching supports such as electronic files of the ancillary materials: Solutions Manual, Instructor's Manual, Test Bank, PowerPoint Lecture Slides, Digital Image Library, and accompanying Excel files.

Instructor's Manual. This manual, revised for the new edition by Tracie Lee, Boise State University, includes teaching notes, chapter overview, an outline for each chapter, and solutions to the problems in the text.

Test Bank. Updated for the new edition by Leslie Sukup, Ferris State University, and reviewed by Nancy Lambe, University of South Alabama, the Test Bank includes over 2,000 true/false, multiple-choice, and discussion questions/problems at varying levels of difficulty. The Test Bank is available to assign within Connect, as Word files available in the Instructor Resource Library, and through our online test generator. Instructors can organize, edit, and customize questions and answers to rapidly generate tests for paper or online administration.

PowerPoint Lecture Slides. Revised by Avanti Sethi, University of Texas-Dallas, the PowerPoint slides draw on the highlights of each chapter and provide an opportunity for the instructor to emphasize the key concepts in class discussions.

Digital Image Library. All the figures in the book are included for insertion in PowerPoint slides or for class discussion.

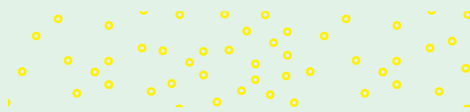



connect®

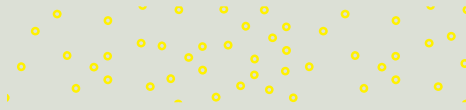

FOR INSTRUCTORS

You're in the driver's seat.

Want to build your own course? No problem. Prefer to use our turnkey, prebuilt course? Easy. Want to make changes throughout the semester? Sure. And you'll save time with Connect's auto-grading too.

65%

Less Time Grading

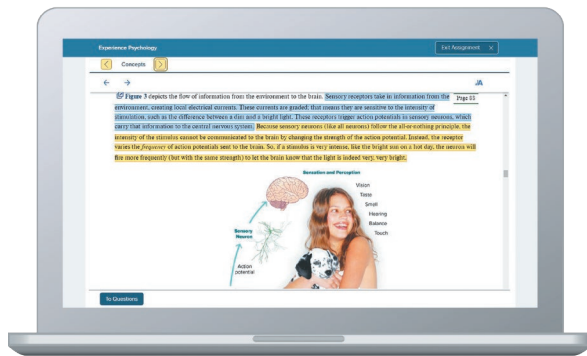

Laptop: McGraw-Hill; Woman/dog: George Doyle/Getty Images

They'll thank you for it.

Adaptive study resources like SmartBook® 2.0 help your students be better prepared in less time. You can transform your class time from dull definitions to dynamic debates. Find out more about the powerful personalized learning experience available in SmartBook 2.0 at www.mheducation.com/highered/connect/smartbook

Make it simple, make it affordable.



Connect makes it easy with seamless integration using any of the major Learning Management Systems—Blackboard®, Canvas, and D2L, among others—to let you organize your course in one convenient location. Give your students access to digital materials at a discount with our inclusive access program. Ask your McGraw-Hill representative for more information.

Padlock: Jobalou/Getty Images

Solutions for your challenges.



A product isn't a solution. Real solutions are affordable, reliable, and come with training and ongoing support when you need it and how you want it. Our Customer Experience Group can also help you troubleshoot tech problems—although Connect's 99% uptime means you might not need to call them. See for yourself at **status.mheducation.com**

Checkmark: Jobalou/Getty Images

SUPPORT ^{AT}
every step

FOR STUDENTS

Effective, efficient studying.

Connect helps you be more productive with your study time and get better grades using tools like SmartBook 2.0, which highlights key concepts and creates a personalized study plan. Connect sets you up for success, so you walk into class with confidence and walk out with better grades.

Study anytime, anywhere.

Download the free ReadAnywhere app and access your online eBook or SmartBook 2.0 assignments when it's convenient, even if you're offline. And since the app automatically syncs with your eBook and SmartBook 2.0 assignments in Connect, all of your work is available every time you open it. Find out more at www.mheducation.com/readanywhere

"I really liked this app—it made it easy to study when you don't have your textbook in front of you."

- Jordan Cunningham,
Eastern Washington University



Calendar: owattaphotos/Getty Images

No surprises.

The Connect Calendar and Reports tools keep you on track with the work you need to get done and your assignment scores. Life gets busy; Connect tools help you keep learning through it all.

Learning for everyone.

McGraw-Hill works directly with Accessibility Services Departments and faculty to meet the learning needs of all students. Please contact your Accessibility Services office and ask them to email accessibility@mheducation.com, or visit www.mheducation.com/about/accessibility for more information.

Top: Jenner Images/Getty Images, Left: Hero Images/Getty Images, Right: Hero Images/Getty Images



Note to Students

The material in this text is part of the core knowledge in your education. Consequently, you will derive considerable benefit from your study of operations management, *regardless of your major*. Practically speaking, operations is a course in *management*.

This book describes principles and concepts of operations management. You should be aware that many of these principles and concepts are applicable to other aspects of your professional and personal life. You can expect the benefits of your study of operations management to serve you in those other areas as well.

Some students approach this course with apprehension, and perhaps even some negative feelings. It may be that they have heard that the course contains a certain amount of quantitative material that they feel uncomfortable with, or that the subject matter is dreary, or that the course is about “factory management.” This is unfortunate, because the subject matter of this book is interesting and vital for all business students. While it is true that some of the material is quantitative, numerous examples, solved problems, and answers at the back of the book help with the quantitative material. As for “factory management,” there is material on manufacturing, as well as on services. Manufacturing is important, and something that you should know about for a number of reasons. Look around you. Most of the “things” you see were manufactured: cars, trucks, planes, clothing, shoes, computers, books, pens and pencils, desks, and cell phones. And these are just the tip of the iceberg. So it makes sense to know something about how these things are produced. Beyond all that is the fact that manufacturing is largely responsible for the high standard of living people have in industrialized countries.

After reading each chapter or supplement in the text, attending related classroom lectures, and completing assigned questions and problems, you should be able to do each of the following:

1. *Identify the key features of that material.*
2. *Define and use terminology.*
3. *Solve typical problems.*
4. *Recognize applications of the concepts and techniques covered.*

5. *Discuss the subject matter* in some depth, including its relevance, managerial considerations, and advantages and limitations.

You will encounter a number of chapter supplements. Check with your course syllabus to determine which ones are included.

This book places an emphasis on problem solving. There are many examples throughout the text illustrating solutions. In addition, at the end of most chapters and supplements you will find a group of solved problems. The examples within the chapter itself serve to illustrate concepts and techniques. Too much detail at those points would be counterproductive. Yet, later on, when you begin to solve the end-of-chapter problems, you will find the solved problems quite helpful. Moreover, those solved problems usually illustrate more and different details than the problems within the chapter.

I suggest the following approach to increase your chances of getting a good grade in the course:

1. Do the class preparation exercises for each chapter if they are available from your instructor.
2. Look over the chapter outline and learning objectives.
3. Read the chapter summary, and then skim the chapter.
4. Read the chapter and take notes.
5. Look over and try to answer some of the discussion and review questions.
6. Work the assigned problems, referring to the solved problems and chapter examples as needed.

Note that the answers to many problems are given at the end of the book. Try to solve each problem before turning to the answer. Remember—tests don’t come with answers.

And here is one final thought: Homework is on the Highway to Success, whether it relates to your courses, the workplace, or life! So do your homework, so you can have a successful journey!

W.J.S.

Brief Contents

Preface vii

- 1** Introduction to Operations Management 2
- 2** Competitiveness, Strategy, and Productivity 40
- 3** Forecasting 74
- 4** Product and Service Design 138
 - SUPPLEMENT TO CHAPTER 4:** Reliability 176
- 5** Strategic Capacity Planning for Products and Services 190
 - SUPPLEMENT TO CHAPTER 5:** Decision Theory 222
- 6** Process Selection and Facility Layout 244
- 7** Work Design and Measurement 300
 - SUPPLEMENT TO CHAPTER 7:** Learning Curves 336
- 8** Location Planning and Analysis 348
- 9** Management of Quality 378
- 10** Quality Control 418
- 11** Aggregate Planning and Master Scheduling 464
- 12** Inventory Management 502
- 13** MRP and ERP 560
- 14** JIT and Lean Operations 610
 - SUPPLEMENT TO CHAPTER 14:** Maintenance 646
- 15** Supply Chain Management 654
- 16** Scheduling 692
- 17** Project Management 732
- 18** Management of Waiting Lines 784
- 19** Linear Programming 824

Appendix A: Answers to Selected Problems 858

Appendix B: Tables 870

Appendix C: Working with the Normal Distribution 876

Appendix D: Ten Things to Remember Beyond the Final Exam 882

Company Index 883

Subject Index 884

Contents

Preface vii

1 Introduction to Operations Management 2

Introduction	4
Production of Goods Versus Providing Services	8
Why Learn About Operations Management?	10
Career Opportunities and Professional Societies	12
Process Management	13
The Scope of Operations Management	14
Reading: <i>Why Manufacturing Matters</i>	17
Operations Management and Decision Making	18
Reading: <i>Analytics</i>	20
The Historical Evolution of Operations Management	21
Operations Today	24
Reading: <i>Agility Creates a Competitive Edge</i>	26
Key Issues for Today's Business Operations	27
Readings: <i>Sustainable Kisses</i>	28
<i>Diet and the Environment: Vegetarian vs. Nonvegetarian</i>	29
Operations Tour: <i>Wegmans Food Markets</i>	33
Summary	36
Key Points	36
Key Terms	36
Discussion and Review Questions	36
Taking Stock	37
Critical Thinking Exercises	37
Case: <i>Hazel</i>	38
Selected Bibliography and Further Readings	38
Problem-Solving Guide	39

2 Competitiveness, Strategy, and Productivity 40

Introduction	42
Competitiveness	42
Mission and Strategies	44
Readings: <i>Amazon Ranks High in Customer Service</i>	45
<i>Low Inventory Can Increase Agility</i>	50
Operations Strategy	51
Implications of Organization Strategy for Operations Management	54
Transforming Strategy into Action: The Balanced Scorecard	54
Productivity	56
Readings: <i>Why Productivity Matters</i>	59
<i>Dutch Tomato Growers' Productivity Advantage</i>	60
<i>Productivity Improvement</i>	62
Summary	62
Key Points	63
Key Terms	63
Solved Problems	63
Discussion and Review Questions	64
Taking Stock	64
Critical Thinking Exercises	65
Problems	65
Cases: <i>Home-Style Cookies</i>	67
<i>Hazel Revisited</i>	68
<i>"Your Garden Gloves"</i>	69
<i>Girlfriend Collective</i>	69
Operations Tour: <i>The U.S. Postal Service</i>	70
Selected Bibliography and Further Readings	73

3 Forecasting 74

Introduction	76
Features Common to All Forecasts	78
Elements of a Good Forecast	78

Forecasting and the Supply Chain	79
Steps in the Forecasting Process	79
Approaches to Forecasting	80
Qualitative Forecasts	80
Forecasts Based on Time-Series Data	82
Associative Forecasting Techniques	98
Reading:	
<i>Lilacs</i>	104
Forecast Accuracy	104
Reading:	
<i>High Forecasts Can be Bad News</i>	106
Monitoring Forecast Error	107
Choosing a Forecasting Technique	111
Using Forecast Information	112
Computer Software in Forecasting	113
Operations Strategy	113
Reading:	
<i>Gazing at the Crystal Ball</i>	114
Summary	115
Key Points	117
Key Terms	117
Solved Problems	118
Discussion and Review Questions	124
Taking Stock	125
Critical Thinking Exercises	125
Problems	125

Cases:

<i>M&L Manufacturing</i>	136
<i>Highline Financial Services, Ltd.</i>	137
Selected Bibliography and Further Readings	137

4 Product and Service Design 138

Reading:

<i>Design as a Business Strategy</i>	140
--------------------------------------	-----

Introduction 140

Reading:

<i>Dutch Boy Brushes Up Its Paints</i>	142
--	-----

Idea Generation 142

Reading:

<i>Vlasic's Big Pickle Slices</i>	143
-----------------------------------	-----

Legal and Ethical Considerations	144
Human Factors	145
Cultural Factors	145

Reading:

<i>Green Tea Ice Cream? Kale Soup?</i>	146
--	-----

Global Product and Service Design 146

Environmental Factors: Sustainability 146

Readings:

<i>Kraft Foods' Recipe for Sustainability</i>	148
---	-----

<i>China Clamps Down on Recyclables</i>	149
---	-----

<i>Recycle City: Maria's Market</i>	150
-------------------------------------	-----

Other Design Considerations 151

Readings:

<i>Lego A/S in the Pink</i>	152
-----------------------------	-----

<i>Fast-Food Chains Adopt Mass Customization</i>	155
--	-----

Phases in Product Design and Development 162

Designing for Production 163

Service Design 165

Reading:

<i>The Challenges of Managing Services</i>	169
--	-----

Operations Strategy 170

Summary 170

Key Points 171

Key Terms 171

Discussion and Review Questions 171

Taking Stock 172

Critical Thinking Exercises 172

Problems 172

Operations Tour:

<i>High Acres Landfill</i>	174
----------------------------	-----

Selected Bibliography and Further Readings 174

SUPPLEMENT TO CHAPTER 4: Reliability 176

5 Strategic Capacity Planning for Products and Services 190

Introduction 191

Reading:

<i>Excess Capacity Can Be Bad News!</i>	192
---	-----

Capacity Decisions Are Strategic 193

Defining and Measuring Capacity	194	Designing Process Layouts	281
Determinants of Effective Capacity	196	<i>Summary</i>	285
Strategy Formulation	197	<i>Key Points</i>	286
Forecasting Capacity Requirements	198	<i>Key Terms</i>	286
Additional Challenges of Planning Service Capacity	200	<i>Solved Problems</i>	286
Do It In-House or Outsource It?	201	<i>Discussion and Review Questions</i>	290
Reading:		<i>Taking Stock</i>	291
<i>My Compliments to the Chef, Er, Buyer</i>	202	<i>Critical Thinking Exercises</i>	291
Developing Capacity Strategies	202	<i>Problems</i>	291
Constraint Management	207	<i>Selected Bibliography and Further Readings</i>	298
Evaluating Alternatives	207	7 Work Design and Measurement	300
Operations Strategy	213	Introduction	301
<i>Summary</i>	213	Job Design	301
<i>Key Points</i>	214	Quality of Work Life	305
<i>Key Terms</i>	214	Methods Analysis	310
<i>Solved Problems</i>	214	Reading:	
<i>Discussion and Review Questions</i>	216	<i>Taylor's Techniques Help UPS</i>	311
<i>Taking Stock</i>	217	Motion Study	315
<i>Critical Thinking Exercises</i>	217	Work Measurement	316
<i>Problems</i>	217	Operations Strategy	327
Case:		<i>Summary</i>	328
<i>Outsourcing of Hospital Services</i>	221	<i>Key Points</i>	328
<i>Selected Bibliography and Further Readings</i>	221	<i>Key Terms</i>	329
SUPPLEMENT TO CHAPTER 5: Decision Theory	222	<i>Solved Problems</i>	329
		<i>Discussion and Review Questions</i>	330
6 Process Selection and Facility Layout	244	<i>Taking Stock</i>	331
Introduction	246	<i>Critical Thinking Exercises</i>	331
Process Selection	246	<i>Problems</i>	331
Operations Tour:		<i>Selected Bibliography and Further Readings</i>	334
<i>Morton Salt</i>	250	SUPPLEMENT TO CHAPTER 7: Learning Curves	336
Technology	252		
Readings:		8 Location Planning and Analysis	348
<i>Foxconn Shifts Its Focus to Automation</i>	254	The Need for Location Decisions	350
<i>Zipline Drones Save Lives in Rwanda</i>	258	The Nature of Location Decisions	350
<i>Self-Driving Vehicles</i>	259	Global Locations	352
Process Strategy	260	Reading:	
Strategic Resource Organization: Facilities Layout	260	<i>Coffee?</i>	355
Reading:		General Procedure for Making Location Decisions	355
<i>A Safe Hospital Room of the Future</i>	269	Identifying a Country, Region, Community, and Site	356
Designing Product Layouts: Line Balancing	272	Service and Retail Locations	363
Reading:		Evaluating Location Alternatives	364
<i>BMW's Strategy: Flexibility</i>	280	<i>Summary</i>	370
		<i>Key Points</i>	370

Key Terms 371
 Solved Problems 371
 Discussion and Review Questions 372
 Taking Stock 372
 Critical Thinking Exercises 373
 Problems 373
Case:
 Hello, Walmart? 377
 Selected Bibliography and Further Readings 377

9 Management of Quality 378

Introduction 379
 The Evolution of Quality Management 380
 The Foundations of Modern Quality Management:
 The Gurus 381
 Insights on Quality Management 383
Readings:
 American Fast-Food Restaurants Are Having
 Success in China 386
 Hyundai: Exceeding Expectations 389
 Quality and Performance Excellence Awards 391
 Quality Certification 392
 Quality and the Supply Chain 393
 Total Quality Management 394
 Problem Solving and Process Improvement 398
 Quality Tools 401
 Operations Strategy 409
 Summary 409
 Key Points 409
 Key Terms 410
 Solved Problem 410
 Discussion and Review Questions 411
 Taking Stock 412
 Critical Thinking Exercises 412
 Problems 412
Cases:
 Chick-n-Gravy Dinner Line 414
 Tip Top Markets 415
 Selected Bibliography and Further Readings 416

10 Quality Control 418

Introduction 419
 Inspection 420
Reading:
 Falsified Inspection Reports Create Major Risks
 and Job Losses 424
 Statistical Process Control 425

Process Capability 443

Readings:

RFID Chips Might Cut Drug Errors in
 Hospitals 448

Operations Strategy 448

Summary 449

Key Points 450

Key Terms 450

Solved Problems 450

Discussion and Review Questions 454

Taking Stock 455

Critical Thinking Exercises 455

Problems 456

Cases:

Toys, Inc. 462

Tiger Tools 462

Selected Bibliography and Further Readings 463

11 Aggregate Planning and Master Scheduling 464

Introduction 466

Reading:

Duplicate Orders Can Lead to Excess Capacity 470

Basic Strategies for Meeting Uneven Demand 473

Techniques for Aggregate Planning 476

Aggregate Planning in Services 484

Disaggregating the Aggregate Plan 485

Master Scheduling 486

The Master Scheduling Process 487

Summary 491

Key Points 491

Key Terms 492

Solved Problems 493

Discussion and Review Questions 496

Taking Stock 496

Critical Thinking Exercises 496

Problems 496

Case:

Eight Glasses a Day (EGAD) 501

Selected Bibliography and Further Readings 501

12 Inventory Management 502

Introduction 503

Reading:

\$\$\$ 504

The Nature and Importance of Inventories 504

Requirements for Effective Inventory

Management 507

Readings:

Radio Frequency Identification (RFID) Tags 509
Catch Them Before They Steal! Reducing Inventory Loss With an Assist From AI 510
Drones Can Help With Inventory Management in Warehouses 513

Inventory Ordering Policies 513

How Much to Order: Economic Order Quantity Models 514

Reorder Point Ordering 525

How Much to Order: Fixed-Order-Interval Model 530

The Single-Period Model 533

Operations Strategy 538

Summary 538

Key Points 538

Key Terms 540

Solved Problems 540

Discussion and Review Questions 545

Taking Stock 545

Critical Thinking Exercises 545

Problems 546

Cases:

UPD Manufacturing 553

Grill Rite 554

Farmers Restaurant 554

Operations Tours:

Bruegger's Bagel Bakery 556

PSC, INC. 557

Selected Bibliography and Further Readings 559

13 MRP and ERP 560

Introduction 561

An Overview of MRP 562

MRP Inputs 563

MRP Processing 566

MRP Outputs 573

Other Considerations 574

MRP in Services 576

Benefits and Requirements of MRP 576

MRP II 577

Capacity Requirements Planning 579

ERP 581

Readings:

The ABCS of ERP 583

11 Common ERP Mistakes and How to Avoid Them 587

Operations Strategy 589

Summary 589

Key Points 590

Key Terms 590

Solved Problems 590

Discussion and Review Questions 599

Taking Stock 599

Critical Thinking Exercises 600

Problems 600

Cases:

Promotional Novelties 605

DMD Enterprises 606

Operations Tour:

Stickley Furniture 606

Selected Bibliography and Further Readings 609

14 JIT and Lean Operations 610

Introduction 612

Reading:

Toyota Recalls 614

Supporting Goals 615

Building Blocks 616

Reading:

General Mills Studied NASCAR Pit Crew to Reduce Changeover Time 619

Lean Tools 632

Reading:

Gemba Walks 635

Transitioning to a Lean System 635

Lean Services 637

JIT II 638

Operations Strategy 638

Summary 639

Key Points 639

Key Terms 640

Solved Problems 640

Discussion and Review Questions 641

Taking Stock 642

Critical Thinking Exercises 642

Problems 642

Case:

Level Operations 643

Operations Tour:

Boeing 644

Selected Bibliography and Further Readings 645

SUPPLEMENT TO CHAPTER 14: Maintenance 646

15 Supply Chain Management 654

Introduction 656

Trends in Supply Chain Management 657

Readings:

Walmart Focuses on Its Supply Chain 660

Supply Chain Transparency 661

At 3M, a Long Road Became a Shorter Road 662

Global Supply Chains 663

ERP and Supply Chain Management 663

Ethics and the Supply Chain 664

Small Businesses 664

Management Responsibilities 665

Procurement 667

E-Business 670

Supplier Management 671

Inventory Management 674

Order Fulfillment 675

Logistics 676

Operations Tour:

Wegmans' Shipping System 677

Readings:

UPS Sets the Pace for Deliveries and Safe Driving 679

Springdale Farm 680

Active, Semi-Passive, and Passive RFID Tags 681

Creating an Effective Supply Chain 681

Readings:

Clicks or Bricks, or Both? 683

Easy Returns 684

Strategy 686

Summary 687

Key Points 687

Key Terms 687

Discussion and Review Questions 687

Taking Stock 688

Critical Thinking Exercises 688

Problems 688

Case:

Mastertag 689

Selected Bibliography and Further Readings 690

16 Scheduling 692

Scheduling Operations 694

Scheduling in Low-Volume Systems 697

Scheduling Services 715

Operations Strategy 719

Summary 719

Key Points 719

Key Terms 720

Solved Problems 720

Discussion and Review Questions 724

Taking Stock 724

Critical Thinking Exercises 724

Problems 725

Case:

Hi-Ho, Yo-Yo, Inc. 731

Selected Bibliography and Further Readings 731

17 Project Management 732

Introduction 734

Project Life Cycle 734

Behavioral Aspects of Project Management 736

Reading:

Artificial Intelligence Will Help

Project Managers 740

Work Breakdown Structure 741

Planning and Scheduling with Gantt Charts 741

PERT and CPM 742

Deterministic Time Estimates 745

A Computing Algorithm 746

Probabilistic Time Estimates 753

Determining Path Probabilities 756

Simulation 758

Budget Control 759

Time–Cost Trade-Offs: Crashing 759

Advantages of Using PERT and Potential Sources of Error 762

Critical Chain Project Management 763

Other Topics in Project Management 763

Project Management Software 764

Operations Strategy 764

Risk Management 765

Summary 766

Key Points 767

Key Terms 767

Solved Problems 767

Discussion and Review Questions 774

Taking Stock 774

Critical Thinking Exercises 774

Problems 774

Case:

Time, Please 781

Selected Bibliography and Further Readings 782

18 Management of Waiting Lines	784	19 Linear Programming	824
Why Is There Waiting?	786	Introduction	825
Reading:		Linear Programming Models	826
<i>New Yorkers Do Not Like Waiting in Line</i>	787	Graphical Linear Programming	828
Managerial Implications of Waiting Lines	787	The Simplex Method	840
Goal of Waiting-Line Management	788	Computer Solutions	840
Characteristics of Waiting Lines	789	Sensitivity Analysis	843
Measures of Waiting-Line Performance	792	<i>Summary</i>	846
Queuing Models: Infinite-Source	793	<i>Key Points</i>	846
Queuing Model: Finite-Source	807	<i>Key Terms</i>	846
Constraint Management	813	<i>Solved Problems</i>	846
The Psychology of Waiting	813	<i>Discussion and Review Questions</i>	849
Reading:		<i>Problems</i>	849
<i>David H. Maister on the Psychology of Waiting</i>	814	Cases:	
Operations Strategy	814	<i>Son, Ltd.</i>	853
Reading:		<i>Custom Cabinets, Inc.</i>	854
<i>Managing Waiting Lines at Disney World</i>	815	<i>Selected Bibliography and Further Readings</i>	856
<i>Summary</i>	815	APPENDIX A	Answers to Selected Problems 858
<i>Key Points</i>	816	APPENDIX B	Tables 870
<i>Key Terms</i>	816	APPENDIX C	Working with the Normal Distribution 876
<i>Solved Problems</i>	816	APPENDIX D	Ten Things to Remember Beyond the Final Exam 882
<i>Discussion and Review Questions</i>	818	<i>Company Index</i>	883
<i>Taking Stock</i>	818	<i>Subject Index</i>	884
<i>Critical Thinking Exercises</i>	818		
<i>Problems</i>	818		
Case:			
<i>Big Bank</i>	822		
<i>Selected Bibliography and Further Readings</i>	822		

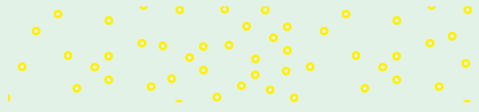

Operations Management

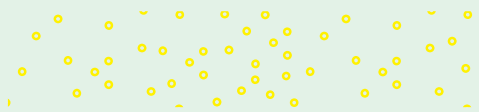

1

CHAPTER

Introduction to Operations Management

LEARNING OBJECTIVES

After completing this chapter, you should be able to:

- LO1.1** Define the terms *operations management* and *supply chain*.
- LO1.2** Identify similarities and differences between production and service operations.
- LO1.3** Explain the importance of learning about operations management.
- LO1.4** Identify the three major functional areas of organizations and describe how they interrelate.
- LO1.5** Summarize the two major aspects of process management.
- LO1.6** Describe the operations function and the nature of the operations manager's job.
- LO1.7** Explain the key aspects of operations management decision making.
- LO1.8** Briefly describe the historical evolution of operations management.
- LO1.9** Describe current issues in business that impact operations management.
- LO1.10** Explain the importance of ethical decision making.
- LO1.11** Explain the need to manage the supply chain

CHAPTER OUTLINE

- | | | |
|---|---|---|
| 1.1 Introduction 4 | 1.7 Operations Management and Decision Making 18 | The Influence of Japanese Manufacturers 23 |
| 1.2 Production of Goods Versus Providing Services 8 | Models 18 | 1.9 Operations Today 24 |
| 1.3 Why Learn About Operations Management? 10 | Quantitative Approaches 19 | 1.10 Key Issues for Today's Business Operations 27 |
| 1.4 Career Opportunities and Professional Societies 12 | Performance Metrics 19 | Environmental Concerns 27 |
| 1.5 Process Management 13 | Analysis of Trade-Offs 19 | Ethical Conduct 29 |
| Managing a Process to Meet Demand 13 | Degree of Customization 20 | The Need to Manage the Supply Chain 31 |
| Process Variation 14 | A Systems Perspective 20 | Elements of Supply Chain Management 32 |
| 1.6 The Scope of Operations Management 14 | Establishing Priorities 20 | Operations Tour: Wegmans Food Markets 33 |
| Managing the Supply Chain to Achieve Schedule, Cost, and Quality Goals 15 | 1.8 The Historical Evolution of Operations Management 21 | Case: Hazel 38 |
| | The Industrial Revolution 21 | Problem-Solving Guide 39 |
| | Scientific Management 21 | |
| | The Human Relations Movement 23 | |
| | Decision Models and Management Science 23 | |



Zapp2Photo/Shutterstock

Recalls of automobiles, foods, toys, and other products; major oil spills; and even dysfunctional state and federal legislatures are all examples of operations failures. They underscore the need for effective operations management. Examples of operations successes include the many electronic devices we all use, medical breakthroughs in diagnosing and treating ailments, and high-quality goods and services that are widely available.

Operations is what businesses do. Operations are processes that either provide services or create goods. Operations take place in businesses such as restaurants, retail stores, supermarkets, factories, hospitals, and colleges and universities. In fact, they take place in every business organization. Moreover, operations are the core of what a business organization does.

As you read this book, you will learn about managing those operations. The subject matter is relevant for you regardless of your major. Productivity, quality, e-business, competition, and customer satisfaction are important for every aspect of a business organization. This first chapter presents an introduction and overview of operations management. Among the issues it addresses are: What is operations management? Why is it important? What do operations management professionals do?

The chapter also provides a description of the historical evolution of operations management and a discussion of the trends and issues that impact operations management.

You will learn about (1) the economic balance that every business organization seeks to achieve; (2) the condition that generally exists that makes achieving the economic balance challenging; (3) the line function that is the core of every business organization; (4) key steps in the history and evolution of operations management; (5) the differences and similarities between producing products and delivering services; (6) what a supply chain is, and why it is essential to manage it; and (7) the key issues for today's business operations.

1.1 INTRODUCTION

LO1.1 Define the terms *operations management* and *supply chain*.

Goods Physical items produced by business organizations.

Services Activities that provide some combination of time, location, form, and psychological value.

Operations is that part of a business organization that is responsible for producing goods and/or services. **Goods** are physical items that include raw materials, parts, subassemblies such as motherboards that go into computers, and final products such as cell phones and automobiles. **Services** are activities that provide some combination of time, location, form, or psychological value. Examples of goods and services are found all around you. Every book you read, every video you watch, every e-mail or text message you send, every telephone conversation you have, and every medical treatment you receive involves the operations function of one or more organizations. So does everything you wear, eat, travel in, sit on, and access through the internet. The operations function in business can also be viewed from a more far-reaching perspective: The collective success or failure of companies' operations functions has an impact on the ability of a nation to compete with other nations, and on the nation's economy.

The ideal situation for a business organization is to achieve an economic match of supply and demand. Having excess supply or excess capacity is wasteful and costly; having too little means lost opportunity and possible customer dissatisfaction. The key functions on the supply side are operations and supply chains, and sales and marketing on the demand side.

While the operations function is responsible for producing products and/or delivering services, it needs the support and input from other areas of the organization. Business organizations have three basic functional areas, as depicted in Figure 1.1: finance, marketing, and operations. It doesn't matter whether the business is a retail store, a hospital, a manufacturing firm, a car wash, or some other type of business; all business organizations have these three basic functions.

Finance is responsible for securing financial resources at favorable prices and allocating those resources throughout the organization, as well as budgeting, analyzing investment proposals, and providing funds for operations. Marketing is responsible for assessing consumer wants and needs, and selling and promoting the organization's goods or services. Operations is responsible for producing the goods or providing the services offered by the organization. To put this into perspective, if a business organization were a car, operations would be its engine. And just as the engine is the core of what a car does, in a business organization, operations is the core of what the organization does. Operations management is responsible for managing that core. Hence, **operations management** is the management of systems or processes that create goods and/or provide services.

Operations and supply chains are intrinsically linked, and no business organization could exist without both. A **supply chain** is the sequence of organizations—their facilities, functions, and activities—that are involved in producing and delivering a product or service. The sequence begins with basic suppliers of raw materials and extends all the way to the final customer. See Figure 1.2. Facilities might include warehouses, factories, processing centers, offices, distribution centers, and retail outlets. Functions and activities include forecasting, purchasing, inventory management, information management, quality assurance, scheduling, production, distribution, delivery, and customer service.

Figure 1.3a provides another illustration of a supply chain: a chain that extends from wheat growing on a farm and ends with a customer buying a loaf of bread in a supermarket. The value of the product increases as it moves through the supply chain.

Operations management

The management of systems or processes that create goods and/or provide services.

Supply chain A sequence of organizations—their facilities, functions, and activities—that are involved in producing and delivering a product or service.

FIGURE 1.1

The three basic functions of business organizations

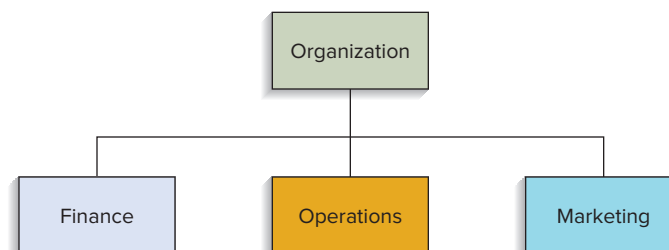

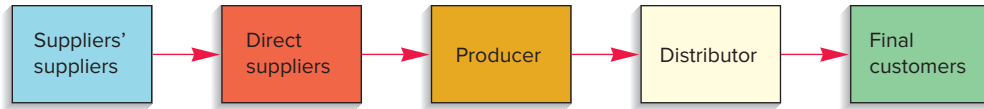

FIGURE 1.2
A simple product supply chain



FIGURE 1.3A
A supply chain for bread

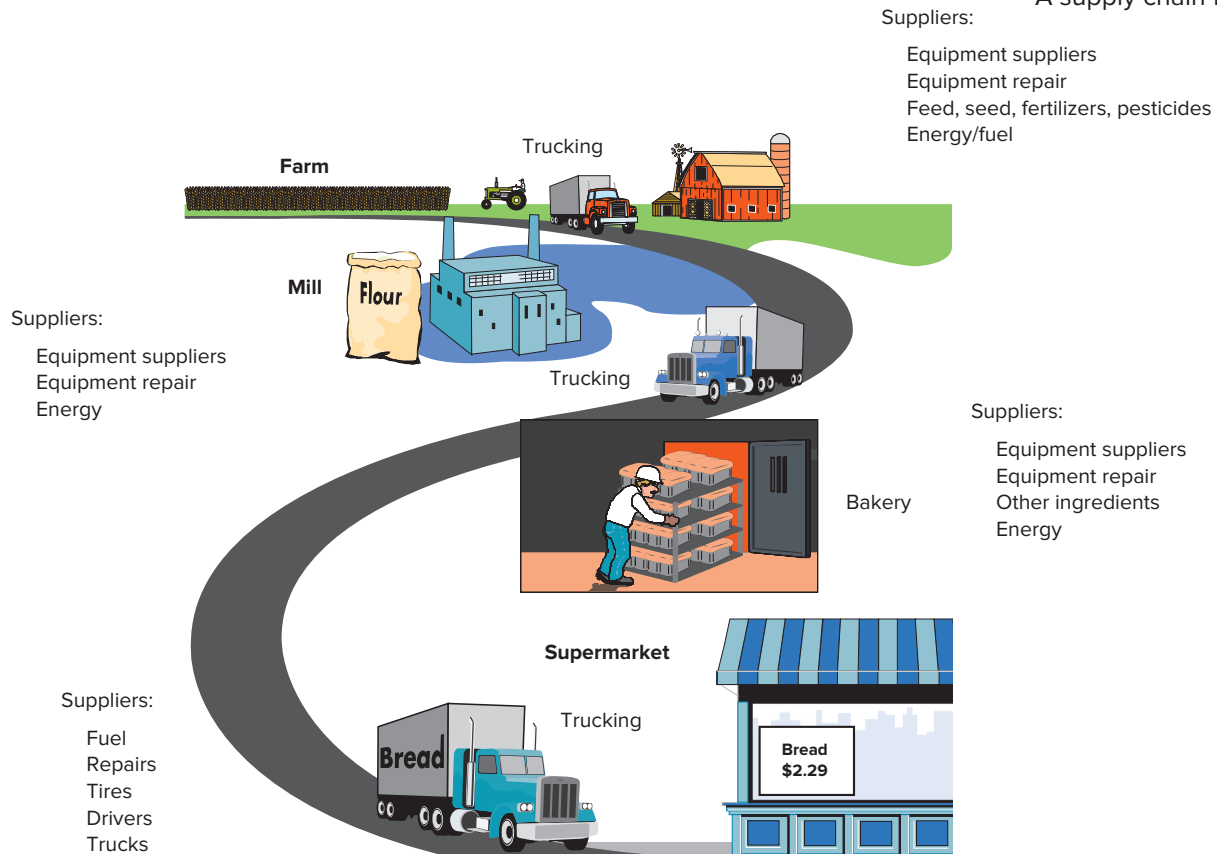
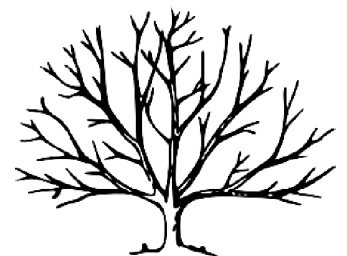

FIGURE 1.3B



One way to think of a supply chain is that it is like a chain, as its name implies. This is shown in Figure 1.2. The links of the chain would represent various production and/or service operations, such as factories, storage facilities, activities, and modes of transportation (trains, railroads, ships, planes, cars, and people). The chain illustrates both the *sequential* nature of a supply chain and the interconnectedness of the elements of the supply chain. Each link is a customer of the previous link and a supplier to the following link. It also helps to understand that if any one of the links fails for any reason (quality or delivery issues, weather problems, or some other problem [there are numerous possibilities]), that can interrupt the flow in the supply chain for the following portion of the chain.

Another way to think of a supply chain is as a tree with many branches, as shown in Figure 1.3b. The main branches of the tree represent key suppliers and transporters (e.g., trucking companies). That view is helpful in grasping the size and complexity that often exists in supply chains. Notice that the main branches of the tree have side branches (their own key suppliers), and those side branches also have their own side branches (their own key suppliers). In fact, an extension of the tree view of a supply chain is that each supplier

(branch) has its own supply tree. Referring to Figure 1.3a, the farm, mill, and bakery of the trucking companies would have their own “tree” of suppliers.

Supply chains are both external and internal to the organization. The external parts of a supply chain provide raw materials, parts, equipment, supplies, and/or other inputs to the organization, and they deliver outputs that are goods to the organization’s customers. The internal parts of a supply chain are part of the operations function itself, supplying operations with parts and materials, performing work on products, and/or performing services.

The creation of goods or services involves transforming or converting inputs into outputs. Various inputs such as capital, labor, and information are used to create goods or services using one or more *transformation processes* (e.g., storing, transporting, repairing). To ensure that the desired outputs are obtained, an organization takes measurements at various points in the transformation process (*feedback*) and then compares them with previously established standards to determine whether corrective action is needed (*control*). Figure 1.4 depicts the conversion *system*.

Table 1.1 provides some examples of inputs, transformation processes, and outputs. Although goods and services are listed separately in Table 1.1, it is important to note that goods and services often occur jointly. For example, having the oil changed in your car is a service, but the oil that is delivered is a good. Similarly, house painting is a service, but the paint is a good. The goods–service combination is a continuum. It can range from primarily goods, with little service, to primarily service, with few goods. Figure 1.5 illustrates this continuum. Because there are relatively few pure goods or pure services, companies usually sell *product packages*, which are a combination of goods and services. There are elements of both goods production and service delivery in these product packages. This makes managing operations more interesting, and also more challenging.

Table 1.2 provides some specific illustrations of the transformation process.

The essence of the operations function is to *add value* during the transformation process. **Value-added** is the term used to describe the difference between the cost of inputs and the value or price of outputs. In nonprofit organizations, the value of outputs (e.g., highway construction, police and fire protection) is their value to society; the greater the value-added, the greater the effectiveness of these operations. In for-profit organizations, the value of outputs is measured by the prices that customers are willing to pay for those goods or services. Firms use the money generated by value-added for research and development, investment in new facilities and equipment, worker salaries, and *profits*. Consequently, the greater the value-added, the greater the amount of funds available for these purposes. Value can also be psychological, as in *branding*.

Many factors affect the design and management of operations systems. Among them are the degree of involvement of customers in the process and the degree to which technology is used to produce and/or deliver a product or service. The greater the degree of customer

Value-added The difference between the cost of inputs and the value or price of outputs.

FIGURE 1.4
The operations function involves systems for converting inputs into outputs

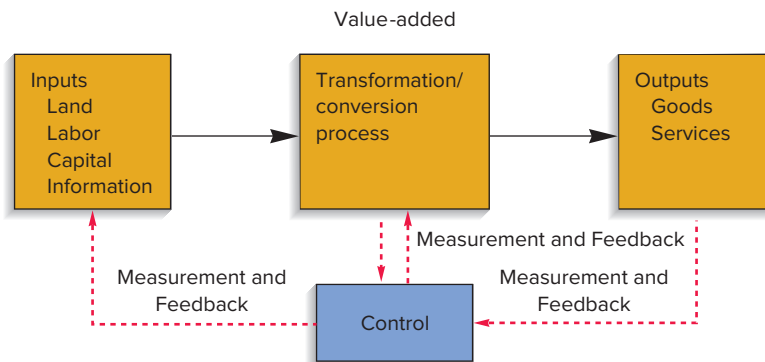

Inputs	Transformation	Outputs
Land	Processes	High goods percentage
Human	Cutting, drilling	Houses
Physical labor	Transporting	Automobiles
Intellectual labor	Teaching	Clothing
Capital	Farming	Computers
Raw materials	Mixing	Machines
Water	Packing	Televisions
Metals	Copying	Food products
Wood	Analyzing	Textbooks
Equipment	Developing	Cell phones
Machines	Searching	High service percentage
Computers	Researching	Health care
Trucks	Repairing	Entertainment
Tools	Innovating	Vehicle repair
Facilities	Debugging	Legal
Hospitals	Selling	Banking
Factories	Emailing	Communication
Retail stores	Writing	
Energy		
Other		
Information		
Time		
Legal constraints		
Government regulations		

TABLE 1.1
Examples of inputs, transformation, and outputs

involvement, the more challenging it can be to design and manage the operation. Technology choices can have a major impact on productivity, costs, flexibility, and quality and customer satisfaction.

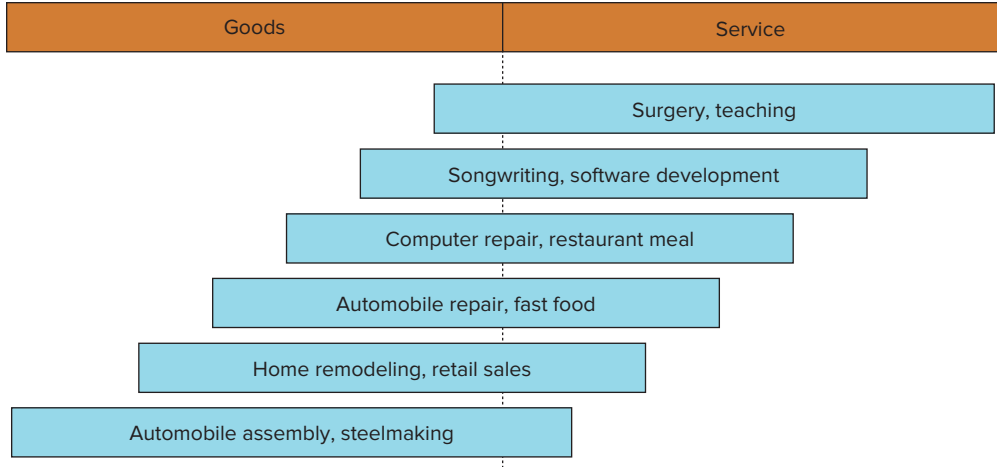

FIGURE 1.5
The goods–service continuum

TABLE 1.2

Illustrations of the transformation process

	Inputs	Processing	Output
Food Processor	Raw vegetables	Cleaning	Canned vegetables
	Metal sheets	Making cans	
	Water	Cutting	
	Energy	Cooking	
	Labor	Packing	
	Building	Labeling	
	Equipment		
Hospital	Doctors, nurses	Examination	Treated patients
	Hospital	Surgery	
	Medical supplies	Monitoring	
	Equipment	Medication	
	Laboratories	Therapy	

1.2 PRODUCTION OF GOODS VERSUS PROVIDING SERVICES

LO1.2 Identify the similarities and differences between production and service operations.

Although goods and services often go hand in hand, there are some very basic differences between the two, differences that impact the management of the goods portion versus management of the service portion. There are also many similarities between the two.

Production of goods results in a *tangible output*, such as an automobile, eyeglasses, a golf ball, a refrigerator—anything that we can see or touch. It may take place in a factory, but it can occur elsewhere. For example, farming and restaurants produce *nonmanufactured* goods. Delivery of service, on the other hand, generally implies an *act*. A physician's examination, TV and auto repair, lawn care, and the projection of a film in a theater are examples of services. The majority of service jobs fall into these categories:

- Professional services (e.g., financial, health care, legal)
- Mass services (e.g., utilities, internet, communications)
- Service shops (e.g., tailoring, appliance repair, car wash, auto repair/maintenance)
- Personal care (e.g., beauty salon, spa, barbershop)
- Government (e.g., Medicare, mail, social services, police, fire)
- Education (e.g., schools, universities)
- Food service (e.g., catering)
- Services within organizations (e.g., payroll, accounting, maintenance, IT, HR, janitorial)
- Retailing and wholesaling
- Shipping and delivery (e.g., truck, railroad, boat, air)
- Residential services (e.g., lawn care, painting, general repair, remodeling, interior design)
- Transportation (e.g., mass transit, taxi, airlines, ambulance)
- Travel and hospitality (e.g., travel bureaus, hotels, resorts)
- Miscellaneous services (e.g., copy service, temporary help)

Manufacturing and service are often different in terms of *what* is done, but quite similar in terms of *how* it is done.

Consider these points of comparison:

Degree of customer contact. Many services involve a high degree of customer contact, although services such as internet providers, utilities, and mail service do not. When there is a high degree of contact, the interaction between server and customer becomes a “moment of truth” that will be judged by the customer every time the service occurs.

Labor content of jobs. Services often have a higher degree of labor content than manufacturing jobs do, although automated services are an exception.

Uniformity of inputs. Service operations are often subject to a higher degree of variability of inputs. Each client, patient, customer, repair job, and so on presents a somewhat unique situation that requires assessment and flexibility. Conversely, manufacturing operations often have a greater ability to control the variability of inputs, which leads to more-uniform job requirements.

Measurement of productivity. Measurement of productivity can be more difficult for service jobs due largely to the high variations of inputs. Thus, one doctor might have a higher level of routine cases to deal with, while another might have more difficult cases. Unless a careful analysis is conducted, it may appear that the doctor with the difficult cases has a much lower productivity than the one with the routine cases.

Quality assurance. Quality assurance is usually more challenging for services due to the higher variation in input, and because delivery and consumption occur at the same time. Unlike manufacturing, which typically occurs away from the customer and allows mistakes that are identified to be corrected, services have less opportunity to avoid exposing the customer to mistakes.

Inventory. Many services tend to involve less use of inventory than manufacturing operations, so the costs of having inventory on hand are lower than they are for manufacturing. However, unlike manufactured goods, services cannot be stored. Instead, they must be provided “on demand.”

Wages. Manufacturing jobs are often well paid, and have less wage variation than service jobs, which can range from highly paid professional services to minimum-wage workers.

Ability to patent. Product designs are often easier to patent than service designs, and some services cannot be patented, making them easier for competitors to copy.

There are also many *similarities* between managing the production of products and managing services. In fact, most of the topics in this book pertain to both. When there are important service considerations, these are highlighted in separate sections. Here are some of the primary factors for both:

- a. Forecasting and capacity planning to match supply and demand
- b. Process management
- c. Managing variations
- d. Monitoring and controlling costs and productivity
- e. Supply chain management
- f. Location planning, inventory management, quality control, and scheduling

Note that many service activities are essential in goods-producing companies. These include training, human resource management, customer service, equipment repair, procurement, and administrative services.

Table 1.3 provides an overview of the differences between the production of goods and service operations. Remember, though, that most systems involve a blend of goods and services.



frantic00/Shutterstock

TABLE 1.3

Typical differences between production of goods and provision of services

Characteristic	Goods	Services
Output	Tangible	Intangible
Customer contact	Low	High
Labor content	Low	High
Uniformity of input	High	Low
Measurement of productivity	Easy	Difficult
Opportunity to correct problems before delivery	High	Low
Inventory	Much	Little
Wages	Narrow range	Wide range
Patentable	Usually	Not usually

1.3 WHY LEARN ABOUT OPERATIONS MANAGEMENT?

LO1.3 Explain the importance of learning about operations management.

Whether operations management is your major or not, the skill set you gain studying operations management will serve you well in your career.

There are many career-related reasons for wanting to learn about operations management, whether you plan to work in the field of operations or not. This is because every aspect of business affects or is affected by operations. Operations and sales are the two line functions in a business organization. All other functions—accounting, finance, marketing, IT, and so on—support the two line functions. Among the service jobs that are closely related to operations are financial services (e.g., stock market analyst, broker, investment banker, and loan officer), marketing services (e.g., market analyst, marketing researcher, advertising manager, and product manager), accounting services (e.g., corporate accountant, public accountant, and budget analyst), and information services (e.g., corporate intelligence, library services, management information systems design services).

A common complaint from employers is that college graduates come to them very focused, when employers would prefer them to have more of a general knowledge of how business organizations operate. This book provides some of the breadth that employers are looking for in their new hires. Apart from the career-related reasons, there is a not-so-obvious one: Through learning about operations and supply chains, you will have a much better understanding of the world you live in, the global dependencies of companies and nations, some of the reasons that companies succeed or fail, and the importance of working with others.

Working together successfully means that all members of the organization understand not only their own role, but they also understand the roles of others. In practice, there is significant interfacing and *collaboration* among the various functional areas, involving *exchange of information* and *cooperative decision making*. For example, although the three primary functions in business organizations perform different activities, many of their decisions impact the other areas of the organization. Consequently, these functions have numerous interactions, as depicted by the overlapping circles shown in Figure 1.6.

Finance and operations management personnel cooperate by exchanging information and expertise in such activities as the following:

1. **Budgeting.** Budgets must be periodically prepared to plan financial requirements. Budgets must sometimes be adjusted, and performance relative to a budget must be evaluated.
2. **Economic analysis of investment proposals.** Evaluation of alternative investments in plant and equipment requires inputs from both operations and finance people.
3. **Provision of funds.** The necessary funding of operations and the amount and timing of funding can be important and even critical when funds are tight. Careful planning can help avoid cash-flow problems.

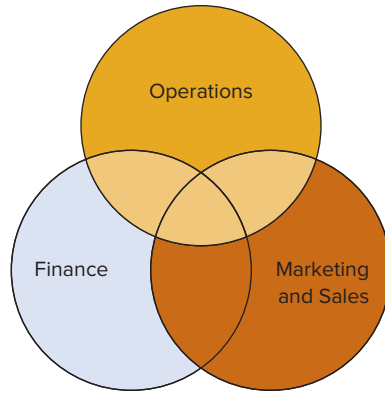

FIGURE 1.6

The three major functions of business organizations overlap

Marketing’s focus is on selling and/or promoting the goods or services of an organization. Marketing is also responsible for assessing customer wants and needs, and for communicating those to operations people (short term) and to design people (long term). That is, operations needs information about demand over the short to intermediate term so that it can plan accordingly (e.g., purchase materials or schedule work), while design people need information that relates to improving current products and services and designing new ones. Marketing, design, and production must work closely together to successfully implement design changes and to develop and produce new products. Marketing can provide valuable insight on what competitors are doing. Marketing also can supply information on consumer preferences so that design will know the kinds of products and features needed; operations can supply information about capacities and judge the *manufacturability* of designs. Operations will also have advance warning if new equipment or skills will be needed for new products or services. Finance people should be included in these exchanges in order to provide information on what funds might be available (short term) and to learn what funds might be needed for new products or services (intermediate to long term). One important piece of information marketing needs from operations is the manufacturing or service **lead time** in order to give customers realistic estimates of how long it will take to fill their orders.

LO1.4 Identify the three major functional areas of organizations and describe how they interrelate.

Thus, marketing, operations, and finance must interface on product and process design, forecasting, setting realistic schedules, quality and quantity decisions, and keeping each other informed on the other’s strengths and weaknesses.

People in every area of business need to appreciate the importance of managing and coordinating operations decisions that affect the supply chain and the matching of supply and demand, and how those decisions impact other functions in an organization.

Operations also interacts with other functional areas of the organization, including legal, management information systems (MIS), accounting, personnel/human resources, and public relations, as depicted in Figure 1.7.

Lead time The time between ordering a good or service and receiving it.



FIGURE 1.7

Operations interfaces with a number of supporting functions

The *legal* department must be consulted on contracts with employees, customers, suppliers, and transporters, as well as on liability and environmental issues.

Accounting supplies information to management on costs of labor, materials, and overhead, and may provide reports on items such as scrap, downtime, and inventories.

Management information systems (MIS) is concerned with providing management with the information it needs to effectively manage. This occurs mainly through designing systems to capture relevant information and designing reports. MIS is also important for managing the control and decision-making tools used in operations management.

The *personnel* or *human resources* department is concerned with the recruitment and training of personnel, labor relations, contract negotiations, wage and salary administration, assisting in manpower projections, and ensuring the health and safety of employees.

Public relations is responsible for building and maintaining a positive public image of the organization. Good public relations provides many potential benefits. An obvious one is in the marketplace. Other potential benefits include public awareness of the organization as a good place to work (labor supply), improved chances of approval of zoning change requests, community acceptance of expansion plans, and instilling a positive attitude among employees.

1.4 CAREER OPPORTUNITIES AND PROFESSIONAL SOCIETIES

There are many career opportunities in the operations management and supply chain fields. Among the numerous job titles are operations manager, production analyst, production manager, inventory manager, purchasing manager, schedule coordinator, distribution manager, supply chain manager, quality analyst, and quality manager. Other titles include office manager, store manager, and service manager.

People who work in the operations field should have a skill set that includes both people skills and knowledge skills. People skills include political awareness; mentoring ability; and collaboration, negotiation, and communication skills. Knowledge skills, necessary for credibility and good decision making, include product and/or service knowledge, process knowledge, industry and global knowledge, financial and accounting skills, and project management skills. See Table 1.4.

If you are thinking of a career in operations management, you can benefit by joining one or more of the following professional societies.

APICS, the Association for Operations Management 8430 West Bryn Mawr Avenue, Suite 1000, Chicago, Illinois 60631 www.apics.org

American Society for Quality (ASQ) 230 West Wells Street, Milwaukee, Wisconsin 53203 www.asq.org

TABLE 1.4
Sample operations management job descriptions

Production Supervisor	Supply Chain Manager	Social Media Product Manager
<ul style="list-style-type: none"> • Manage a production staff of 10–20. • Ensure the department meets daily goals through the management of productivity. • Enforce safety policies. • Coordinate work between departments. • Have strong problem-solving skills, and strong written and oral communication skills. 	<ul style="list-style-type: none"> • Have a general knowledge of materials management, information systems, and basic statistics. • Direct, monitor, evaluate, and motivate employee performance. • Be knowledgeable about shipping regulations. • Manage budgetary accounts. • Manage projects. 	<ul style="list-style-type: none"> • Identify ways to increase consumer engagement. • Analyze the key performance indicators and recommend improvements. • Lead cross-functional teams to define product specifications. • Collaborate with design and technical to create key product improvements. • Develop requirements for new website enhancements. • Monitor the competition to identify need for changes.

Institute for Supply Management (ISM) 2055 East Centennial Circle, Tempe, Arizona 85284 www.ism.ws

Institute for Operations Research and the Management Sciences (INFORMS) 901 Elkridge Landing Road, Linthicum, Maryland 21090-2909 www.informs.org

The Production and Operations Management Society (POMS) College of Engineering, Florida International University, EAS 2460, 10555 West Flagler Street, Miami, Florida 33174 www.poms.org

The Project Management Institute (PMI) 4 Campus Boulevard, Newtown Square, Pennsylvania 19073-3299 www.pmi.org

Council of Supply Chain Management Professionals (CSCMP) 333 East Butterfield Road, Suite 140, Lombard, Illinois 60148 <https://cscmp.org>

APICS, ASQ, ISM, and other professional societies offer a practitioner certification examination that can enhance your qualifications. Information about job opportunities can be obtained from all of these societies, as well as from other sources, such as the Decision Sciences Institute (University Plaza, Atlanta, Georgia 30303) and the Institute of Industrial Engineers (25 Technology Park, Norcross, Georgia 30092).

1.5 PROCESS MANAGEMENT

A key aspect of operations management is process management. A **process** consists of one or more actions that transform inputs into outputs. In essence, the central role of all management is process management.

Businesses are composed of many interrelated processes. Generally speaking, there are three categories of business processes:

1. **Upper-management processes.** These govern the operation of the entire organization. Examples include organizational governance and organizational strategy.
2. **Operational processes.** These are the core processes that make up the value stream. Examples include purchasing, production and/or service, marketing, and sales.
3. **Supporting processes.** These support the core processes. Examples include accounting, human resources, and IT (information technology).

Business processes, large and small, are composed of a series of supplier–customer relationships, where every business organization, every department, and every individual operation is both a customer of the previous step in the process and a supplier to the next step in the process. Figure 1.8 illustrates this concept.

A major process can consist of many subprocesses, each having its own goals that contribute to the goals of the overall process. Business organizations and supply chains have many such processes and subprocesses, and they benefit greatly when management is using a process perspective. Business process management (BPM) activities include process design, process execution, and process monitoring. Two basic aspects of this for operations and supply chain management are managing processes to meet demand and dealing with process variability.

Managing a Process to Meet Demand

Ideally, the capacity of a process will be such that its output just matches demand. Excess capacity is wasteful and costly; too little capacity means dissatisfied customers and lost



LO1.5 Summarize the two major aspects of process management.

Process One or more actions that transform inputs into outputs.

FIGURE 1.8

Business processes form a sequence of suppliers and customers

revenue. Having the right capacity requires having accurate forecasts of demand, the ability to translate forecasts into capacity requirements, and a process in place capable of meeting expected demand. Even so, process variation and demand variability can make the achievement of a match between process output and demand difficult. Therefore, to be effective, it is also necessary for managers to be able to deal with variation.

Process Variation

Variation occurs in all business processes. It can be due to variety or variability. For example, random variability is inherent in every process; it is always present. In addition, variation can occur as the result of deliberate management choices to offer customers variety.

There are four basic sources of variation:

1. **The variety of goods or services being offered.** The greater the variety of goods and services, the greater the variation in production or service requirements.
2. **Structural variation in demand.** These variations, which include trends and seasonal variations, are generally predictable. They are particularly important for capacity planning.
3. **Random variation.** This natural variability is present to some extent in all processes, as well as in demand for services and products, and it cannot generally be influenced by managers.
4. **Assignable variation.** These variations are caused by defective inputs, incorrect work methods, out-of-adjustment equipment, and so on. This type of variation can be reduced or eliminated by analysis and corrective action.

Variations can be disruptive to operations and supply chain processes, interfering with optimal functioning. Variations result in additional cost, delays and shortages, poor quality, and inefficient work systems. Poor quality and product shortages or service delays can lead to dissatisfied customers and can damage an organization's reputation and image. It is not surprising, then, that the ability to deal with variability is absolutely necessary for managers.

Throughout this book, you will learn about some of the tools managers use to deal with variation. An important aspect of being able to deal with variation is to use metrics to describe it. Two widely used metrics are the *mean* (average) and the *standard deviation*. The standard deviation quantifies variation around the mean. The mean and standard deviation are used throughout this book in conjunction with variation. So, too, is the normal distribution. Because you will come across many examples of how the normal distribution is used, you may find the overview on working with the normal distribution in the appendix at the end of the book helpful.

1.6 THE SCOPE OF OPERATIONS MANAGEMENT

LO1.6 Describe the operations function and the nature of the operations manager's job.

The scope of operations management ranges across the organization. Operations management people are involved in product and service design, process selection, selection and management of technology, design of work systems, location planning, facilities planning, and quality improvement of the organization's products or services.

The operations function includes many interrelated activities, such as forecasting, capacity planning, scheduling, managing inventories, assuring quality, motivating employees, deciding where to locate facilities, and more.

We can use an airline company to illustrate a service organization's operations system. The system consists of the airplanes, airport facilities, and maintenance facilities, sometimes spread out over a wide territory. The activities include:

Forecasting such things as weather and landing conditions, seat demand for flights, and the growth in air travel.

Capacity planning, essential for the airline to maintain cash flow and make a reasonable profit. (Too few or too many planes, or even the right number of planes but in the wrong places, will hurt profits.)



1000 Words/Shutterstock

Scheduling planes, cargo, and flight and ground crews is an operations function for an airline.

Locating facilities according to managers' decisions on which cities to provide service for, where to locate maintenance facilities, and where to locate major and minor hubs.

Facilities and layout, important in achieving effective use of workers and equipment.

Scheduling of planes for flights and for routine maintenance; scheduling of pilots and flight attendants; and scheduling of ground crews, counter staff, and baggage handlers.

Managing inventories of such items as foods and beverages, first-aid equipment, in-flight magazines, pillows and blankets, and life preservers.

Assuring quality, essential in flying and maintenance operations, where the emphasis is on safety. This is important in dealing with customers at ticket counters, check-in, telephone and electronic reservations, and curbside service, where the emphasis is on efficiency and courtesy.

Motivating and training employees in all phases of operations.

Managing the Supply Chain to Achieve Schedule, Cost, and Quality Goals

Consider a bicycle factory. This might be primarily an *assembly* operation: buying components such as frames, tires, wheels, gears, and other items from suppliers, and then assembling bicycles. The factory also might do some of the *fabrication* work itself, forming frames and making the gears and chains, and it might buy mainly raw materials and a few parts and materials such as paint, nuts and bolts, and tires. Among the key management tasks in either case are scheduling production, deciding which components to make and which to buy, ordering parts and materials, deciding on the style of bicycle to produce and how many, purchasing new equipment to replace old or worn-out equipment, maintaining equipment, motivating workers, and ensuring that quality standards are met.

Obviously, an airline company and a bicycle factory are completely different types of operations. One is primarily a service operation, the other a producer of goods. Nonetheless, these two operations have much in common. Both involve scheduling activities, motivating employees, ordering and managing supplies, selecting and maintaining equipment, satisfying quality standards, and—above all—satisfying customers. Also, in both businesses, the success of the business depends on short- and long-term planning.

Bicycle manufacturing and repair is one of the many jobs that require operations management expertise.



Jetta Productions/Blend Images LLC

A primary function of an operations manager is to guide the system by decision making. Certain decisions affect the *design* of the system, and others affect the *operation* of the system.

System design involves decisions that relate to system capacity, the geographic location of facilities, the arrangement of departments and the placement of equipment within physical structures, product and service planning, and the acquisition of equipment. These decisions usually, but not always, require long-term commitments. Moreover, they are typically *strategic* decisions. *System operation* involves management of personnel, inventory planning and control, scheduling, project management, and quality assurance. These are generally *tactical* and *operational* decisions. Feedback on these decisions involves *measurement* and *control*. In many instances, the operations manager is more involved in day-to-day operating decisions than with decisions relating to system design. However, the operations manager has a vital stake in system design because *system design essentially determines many of the parameters of system operation*. For example, costs, space, capacities, and quality are directly affected by design decisions. Even though the operations manager is not responsible for making all design decisions, he or she can provide those decision makers with a wide range of information that will have a bearing on their decisions.

A number of other areas are part of, or support, the operations function. They include purchasing, industrial engineering, distribution, and maintenance.

Purchasing is responsible for the procurement of materials, supplies, and equipment. Close contact with operations is necessary to ensure correct quantities and timing of purchases. The purchasing department is often called on to evaluate vendors for quality, reliability, service, price, and ability to adjust to changing demand. Purchasing is also involved in receiving and inspecting the purchased goods.

Industrial engineering is often concerned with scheduling, performance standards, work methods, quality control, and material handling.

Distribution involves the shipping of goods to warehouses, retail outlets, or final customers.

Maintenance is responsible for general upkeep and the repair of equipment, the buildings and grounds, heating and air-conditioning, parking, removing toxic wastes, and perhaps security.

The operations manager is the key figure in the system. He or she has the ultimate responsibility for the creation of goods or provision of services.



The U.S. economy is becoming more and more service-based. The percentage of employment in manufacturing continues to decrease, while the percentage employed in services continues to increase. However, it would be unwise to assume that manufacturing isn't important to the economy, or that service is more important. Let's see why.

Not only is the percentage of manufacturing jobs decreasing, but the actual number of manufacturing jobs is also decreasing. There are two main reasons for the decline: increases in productivity (many times due to increases in automation), which means fewer workers are needed to maintain manufacturing output; and outsourcing, especially offshoring to countries that have much lower wages, an attractive option for companies seeking to maintain their competitiveness and boost their bottom lines.

However, when companies outsource part (or in some cases, all) of their manufacturing to lower-cost countries, the loss of jobs results in the loss of service jobs as well. Some are lost in the community in retail businesses patronized by the manufacturing workers. Also included in that figure are factory service workers (e.g., workers who do machine repairs, maintenance, material handling, packaging, and so on). General estimates are that four service jobs are lost for each manufacturing job lost.

As the manufacturing base shrinks, workers who lose their manufacturing jobs are finding it tougher to find another opening in manufacturing. Instead, they join the ranks of the unemployed, or take a service job, usually at a lower wage rate than what manufacturing paid.

From a national perspective, not only is work transferred to a foreign country, intellectual knowledge is transferred. Moreover, as time passes, the domestic base of manufacturing skills and know-how is lost.

There are important consequences for taxes as well. Unemployment benefits are costly, and the erosion of federal, state, and local tax bases results in lower tax revenues collected from individuals and from corporations.

Lastly, manufacturing is an important source of innovation. It is responsible for 70 percent of private-sector R&D and 90 percent of U.S. patents (Rana Foroohar, "Go Glocal," *Time*, August 20, 2012, p. 30). Much of the work in getting a product ready for volume production is high-value-added knowledge work that supports future innovation. And innovation generates jobs. "Intel has invested tens of billions of dollars in its factories in Oregon, Arizona, and New Mexico so that they are able to produce the most advanced semiconductors."

Source: Willy Shih and Gary Pisano, "Why Manufacturing Matters for America," Special to CNN, Sept. 21, 2012.

Questions

1. How important is the loss of manufacturing jobs to the nation?
2. Can you suggest some actions the government (federal, state, or local) can take to stem the job loss?
3. What evidence is there of the importance of manufacturing innovation?

The kinds of jobs that operations managers oversee vary tremendously from organization to organization, largely because of the different products or services involved. Thus, managing a banking operation obviously requires a different kind of expertise than managing a steelmaking operation. However, in a very important respect, the *jobs* are the same: They are both essentially *managerial*. The same thing can be said for the job of any operations manager regardless of the kinds of goods or services being created.

The service sector and the manufacturing sector are both important to the economy. The service sector now accounts for more than 70 percent of jobs in the United States, and it is growing in other countries as well. Moreover, the number of people working in services is increasing, while the number of people working in manufacturing is not. The reason for the decline in manufacturing jobs is twofold: As the operations function in manufacturing companies finds more productive ways of producing goods, the companies are able to maintain or even increase their output using fewer workers. Furthermore, some manufacturing work has been *outsourced* to more productive companies, many in other countries, that are able to produce goods at lower costs. Outsourcing and productivity will be discussed in more detail in this and other chapters.

Many of the concepts presented in this book apply equally to manufacturing and service. Consequently, whether your interest at this time is on manufacturing or on service, these concepts will be important, regardless of whether a manufacturing example or service example is used to illustrate the concept.

The Why Manufacturing Matters reading gives another reason for the importance of manufacturing jobs.

1.7 OPERATIONS MANAGEMENT AND DECISION MAKING

LO1.7 Explain the key aspects of operations management decision making.

The chief role of an operations manager is that of planner and decision maker. In this capacity, the operations manager exerts considerable influence over the degree to which the goals and objectives of the organization are realized. Most decisions involve many possible alternatives that can have quite different impacts on costs or profits. Consequently, it is important to make *informed* decisions.

Operations management professionals make a number of key decisions that affect the entire organization. These include the following:

What: What resources will be needed, and in what amounts?

When: When will each resource be needed? When should the work be scheduled? When should materials and other supplies be ordered? When is corrective action needed?

Where: Where will the work be done?

How: How will the product or service be designed? How will the work be done (organization, methods, equipment)? How will resources be allocated?

Who: Who will do the work?

An operations manager's daily concerns include costs (budget), quality, and schedules (time).

Throughout this book, you will encounter the broad range of decisions that operations managers must make, and you will be introduced to the tools necessary to handle those decisions. This section describes general approaches to decision making, including the use of models, quantitative methods, analysis of trade-offs, establishing priorities, ethics, and the systems approach. Models are often a key tool used by all decision makers.

Models

Model An abstraction of reality; a simplified representation of something.

A **model** is an abstraction of reality, a simplified representation of something. For example, a toy car is a model of a real automobile. It has many of the same visual features (shape, relative proportions, wheels) that make it suitable for the child's learning and playing. But the toy does not have a real engine, it cannot transport people, and it does not weigh 3,000 pounds.

Other examples of models include automobile test tracks and crash tests; formulas, graphs, and charts; balance sheets and income statements; and financial ratios. Common statistical models include descriptive statistics such as the mean, median, mode, range, and standard deviation, as well as random sampling, the normal distribution, and regression equations.

Models are sometimes classified as physical, schematic, or mathematical.

Physical models look like their real-life counterparts. Examples include miniature cars, trucks, airplanes, toy animals and trains, and scale-model buildings. The advantage of these models is their visual correspondence with reality. 3-D printers (explained in Chapter 6) are often used to prepare scale models.

Schematic models are more abstract than their physical counterparts; that is, they have less resemblance to the physical reality. Examples include graphs and charts, blueprints, pictures, and drawings. The advantage of schematic models is that they are often relatively simple to construct and change. Moreover, they have some degree of visual correspondence.

Mathematical models are the most abstract: They do not look at all like their real-life counterparts. Examples include numbers, formulas, and symbols. These models are usually the easiest to manipulate, and they are important forms of inputs for computers and calculators.

The variety of models in use is enormous. Nonetheless, all have certain common features: They are all decision-making aids and simplifications of more complex real-life phenomena. Real life involves an overwhelming amount of detail, much of which is irrelevant for any particular problem. Models omit unimportant details so that attention can be concentrated on the most important aspects of a situation.

Because models play a significant role in operations management decision making, they are heavily integrated into the material of this text. For each model, try to learn (1) its purpose, (2) how it is used to generate results, (3) how these results are interpreted and used, and (4) what assumptions and limitations apply.

The last point is particularly important because virtually every model has an associated set of assumptions or conditions under which the model is valid. Failure to satisfy all of the assumptions will make the results suspect. Attempts to apply the results to a problem under such circumstances can lead to disastrous consequences.

Managers use models in a variety of ways and for a variety of reasons. Models are beneficial because they:

1. Are generally easy to use and less expensive than dealing directly with the actual situation.
2. Require users to organize and sometimes quantify information and, in the process, often indicate areas where additional information is needed.
3. Increase understanding of the problem.
4. Enable managers to analyze what-if questions.
5. Serve as a consistent tool for evaluation and provide a standardized format for analyzing a problem.
6. Enable users to bring the power of mathematics to bear on a problem.

This impressive list of benefits notwithstanding, models have certain limitations of which you should be aware. The following are three of the more important limitations.

1. Quantitative information may be emphasized at the expense of qualitative information.
2. Models may be incorrectly applied and the results misinterpreted. The widespread use of computerized models adds to this risk because highly sophisticated models may be placed in the hands of users who are not sufficiently knowledgeable to appreciate the subtleties of a particular model; thus, they are unable to fully comprehend the circumstances under which the model can be successfully employed.
3. The use of models does not guarantee good decisions.

Quantitative Approaches

Quantitative approaches to problem solving often embody an attempt to obtain mathematically optimal solutions to managerial problems. *Quantitative approaches* to decision making in operations management (and in other functional business areas) have been accepted because of calculators and computers capable of handling the required calculations. Computers have had a major impact on operations management. Moreover, the growing availability of software packages for quantitative techniques has greatly increased management's use of those techniques.

Although quantitative approaches are widely used in operations management decision making, it is important to note that managers typically use a combination of qualitative and quantitative approaches, and many important decisions are based on qualitative approaches.

Performance Metrics

Managers use metrics to manage and control operations. There are many metrics in use, including those related to profits, costs, quality, productivity, flexibility, assets, inventories, schedules, and forecast accuracy. As you read each chapter, note the metrics being used and how they are applied to manage operations.

Analysis of Trade-Offs

Operations personnel frequently encounter decisions that can be described as *trade-off* decisions. For example, in deciding on the amount of inventory to stock, the decision maker must take into account the trade-off between the increased level of customer service that the additional inventory would yield and the increased costs required to stock that inventory.

Decision makers sometimes deal with these decisions by listing the advantages and disadvantages—the pros and cons—of a course of action to better understand the consequences



Analytics uses descriptive and predictive models to obtain insight from data and then uses that insight to recommend action or to guide decision making.

Commercial analytics software is available for the challenges of analyzing very large, dynamic data sets, referred to as big data. Analyzing big data presents opportunities for businesses such

as those that operate transactional online systems that generate massive volumes of data. For example, the McKinsey Global Institute estimates that the U.S. health care system could save \$300 billion from analyzing big data.¹

¹“Big Data: The Next Frontier for Innovation, Competition and Productivity as Reported in Building with Big Data,” *The Economist*, May 26, 2011.

of the decisions they must make. In some instances, decision makers add weights to the items on their list that reflect the relative importance of various factors. This can help them “net out” the potential impacts of the trade-offs on their decision.

Degree of Customization

A major influence on the entire organization is the degree of customization of products or services being offered to its customers. Providing highly customized products or services such as home remodeling, plastic surgery, and legal counseling tends to be more labor intensive than providing standardized products such as those you would buy “off the shelf” at a mall store or a supermarket or standardized services such as public utilities and internet services. Furthermore, production of customized products or provision of customized services is generally more time consuming, requires more highly skilled people, and involves more flexible equipment than what is needed for standardized products or services. Customized processes tend to have a much lower volume of output than standardized processes, and customized output carries a higher price tag. The degree of customization has important implications for process selection and job requirements. The impact goes beyond operations and supply chains. It affects marketing, sales, accounting, finance, and information systems.

A Systems Perspective

A systems perspective is almost always beneficial in decision making. Think of it as a “big picture” view. A **system** can be defined as a set of interrelated parts that must work together. In a business organization, the organization can be thought of as a system composed of subsystems (e.g., marketing subsystem, operations subsystem, finance subsystem), which in turn are composed of lower subsystems. The systems approach emphasizes interrelationships among subsystems, but its main theme is that *the whole is greater than the sum of its individual parts*. Hence, from a systems viewpoint, the output and objectives of the organization as a whole take precedence over those of any one subsystem.

A systems perspective is essential whenever something is being designed, redesigned, implemented, improved, or otherwise changed. It is important to take into account the impact on all parts of the system. For example, if the upcoming model of an automobile will add forward collision braking, a designer must take into account how customers will view the change, the cost of producing the new system, installation procedures, and repair procedures. In addition, workers will need training to make and/or assemble the new system, production scheduling may change, inventory procedures may have to change, quality standards will have to be established, advertising must be informed of the new features, and parts suppliers must be selected.

Establishing Priorities

In virtually every situation, managers discover that certain issues or items are more important than others. Recognizing this enables the managers to direct their efforts to where they will do the most good.

Typically, a relatively few issues or items are very important, so that dealing with those factors will generally have a disproportionately large impact on the results achieved. This well-known effect is referred to as the **Pareto phenomenon**. This is one of the most important and pervasive concepts in operations management. In fact, this concept can be applied at all levels of management and to every aspect of decision making, both professional and personal.

System A set of interrelated parts that must work together.

Pareto phenomenon A few factors account for a high percentage of the occurrence of some event(s).

1.8 THE HISTORICAL EVOLUTION OF OPERATIONS MANAGEMENT

Systems for production have existed since ancient times. For example, the construction of pyramids and Roman aqueducts involved operations management skills. The production of goods for sale, at least in the modern sense, and the modern factory system had their roots in the Industrial Revolution.

The Industrial Revolution

The Industrial Revolution began in the 1770s in England and spread to the rest of Europe and to the United States during the 19th century. Prior to that time, goods were produced in small shops by craftsmen and their apprentices. Under that system, it was common for one person to be responsible for making a product, such as a horse-drawn wagon or a piece of furniture, from start to finish. Only simple tools were available; the machines in use today had not been invented.

Then, a number of innovations in the 18th century changed the face of production forever by substituting machine power for human power. Perhaps the most significant of these was the steam engine, because it provided a source of power to operate machines in factories. Ample supplies of coal and iron ore provided materials for generating power and making machinery. The new machines, made of iron, were much stronger and more durable than the simple wooden machines they replaced.

In the earliest days of manufacturing, goods were produced using **craft production**: Highly skilled workers using simple, flexible tools produced goods according to customer specifications.

Craft production had major shortcomings. Because products were made by skilled craftsmen who custom-fitted parts, production was slow and costly. And when parts failed, the replacements also had to be custom made, which was also slow and costly. Another shortcoming was that production costs did not decrease as volume increased; there were no *economies of scale*, which would have provided a major incentive for companies to expand. Instead, many small companies emerged, each with its own set of standards.

A major change occurred that gave the Industrial Revolution a boost: the development of standard gauging systems. This greatly reduced the need for custom-made goods. Factories began to spring up and grow rapidly, providing jobs for countless people who were attracted in large numbers from rural areas.

Despite the major changes that were taking place, management theory and practice had not progressed much from early days. What was needed was an enlightened and more systematic approach to management.

Scientific Management

The scientific management era brought widespread changes to the management of factories. The movement was spearheaded by the efficiency engineer and inventor Frederick Winslow Taylor, who is often referred to as the father of scientific management. Taylor believed in a “science of management” based on observation, measurement, analysis and improvement of work methods, and economic incentives. He studied work methods in great detail to identify the best method for doing each job. Taylor also believed that management should be responsible for planning, carefully selecting and training workers, finding the best way to perform each job, achieving cooperation between management and workers, and separating management activities from work activities.

Taylor’s methods emphasized maximizing output. They were not always popular with workers, who sometimes thought the methods were used to unfairly increase output without a corresponding increase in compensation. Certainly, some companies did abuse workers in their quest for efficiency. Eventually, the public outcry reached the halls of Congress, and hearings were held on the matter. Taylor himself was called to testify in 1911, the same year in which his classic book, *The Principles of Scientific Management*, was published. The publicity from those hearings actually helped scientific management principles to achieve wide acceptance in industry.

LO1.8 Briefly describe the historical evolution of operations management.

Craft production System in which highly skilled workers use simple, flexible tools to produce small quantities of customized goods.

A number of other pioneers also contributed heavily to this movement, including the following:

Frank Gilbreth was an industrial engineer who is often referred to as the father of motion study. He developed principles of motion economy that could be applied to incredibly small portions of a task.

Henry Gantt recognized the value of nonmonetary rewards to motivate workers, and developed a widely used system for scheduling, called Gantt charts.

Harrington Emerson applied Taylor's ideas to organization structure and encouraged the use of experts to improve organizational efficiency. He testified in a congressional hearing that railroads could save a million dollars a day by applying principles of scientific management.

Henry Ford, the great industrialist, employed scientific management techniques in his factories.

During the early part of the 20th century, automobiles were just coming into vogue in the United States. Ford's Model T was such a success that the company had trouble keeping up with orders for the cars. In an effort to improve the efficiency of operations, Ford adopted the scientific management principles espoused by Frederick Winslow Taylor. He also introduced the *moving assembly line*, which had a tremendous impact on production methods in many industries.

Among Ford's many contributions was the introduction of **mass production** to the automotive industry, a system of production in which large volumes of standardized goods are produced by low-skilled or semiskilled workers using highly specialized, and often costly, equipment. Ford was able to do this by taking advantage of a number of important concepts. Perhaps the key concept that launched mass production was **interchangeable parts**, sometimes attributed to Eli Whitney, an American inventor who applied the concept to assembling muskets in the late 1700s. The basis for interchangeable parts was to standardize parts so that any part in a batch of parts would fit any automobile coming down the assembly line. This meant that parts did not have to be custom fitted, as they were in craft production. The standardized parts could also be used for replacement parts. The result was a tremendous decrease in assembly time and cost. Ford accomplished this by standardizing the gauges used to measure parts during production and by using newly developed processes to produce uniform parts.

Mass production System in which low-skilled workers use specialized machinery to produce high volumes of standardized goods.

Interchangeable parts Parts of a product made to such precision that they do not have to be custom fitted.

Model A's, being manufactured on an early Ford assembly line.



Hulton Archive/Getty Images

A second concept used by Ford was the **division of labor**, which Adam Smith wrote about in *The Wealth of Nations* (1776). Division of labor means that an operation, such as assembling an automobile, is divided up into a series of many small tasks, and individual workers are assigned to one of those tasks. Unlike craft production, where each worker was responsible for doing many tasks, and thus required skill, with division of labor the tasks were so narrow that virtually no skill was required.

Together, these concepts enabled Ford to tremendously increase the production rate at his factories using readily available inexpensive labor. Both Taylor and Ford were despised by many workers, because they held workers in such low regard, expecting them to perform like robots. This paved the way for the human relations movement.

Division of labor The breaking up of a production process into small tasks, so that each worker performs a small portion of the overall job.

The Human Relations Movement

Whereas the scientific management movement heavily emphasized the technical aspects of work design, the human relations movement emphasized the importance of the human element in job design. Lillian Gilbreth, a psychologist and the wife of Frank Gilbreth, worked with her husband, focusing on the human factor in work. (The Gilbreths were the subject of a classic film, *Cheaper by the Dozen*.) Many of her studies dealt with worker fatigue. In the following decades, there was much emphasis on motivation. Elton Mayo conducted studies at the Hawthorne division of Western Electric. His studies revealed that in addition to the physical and technical aspects of work, worker motivation is critical for improving productivity. Abraham Maslow developed motivational theories, which Frederick Herzberg refined. Douglas McGregor added Theory X and Theory Y. These theories represented the two ends of the spectrum of how employees view work. Theory X, on the negative end, assumed that workers do not like to work, and have to be controlled—rewarded and punished—to get them to do good work. This attitude was quite common in the automobile industry and in some other industries, until the threat of global competition forced them to rethink that approach. Theory Y, on the other end of the spectrum, assumed that workers enjoy the physical and mental aspects of work and become committed to work. The Theory X approach resulted in an adversarial environment, whereas the Theory Y approach resulted in empowered workers and a more cooperative spirit. William Ouchi added Theory Z, which combined the Japanese approach with such features as lifetime employment, employee problem solving, and consensus building, and the traditional Western approach that features short-term employment, specialists, and individual decision making and responsibility.

Decision Models and Management Science

The factory movement was accompanied by the development of several quantitative techniques. F. W. Harris developed one of the first models in 1915: a mathematical model for inventory order size. In the 1930s, three coworkers at Bell Telephone Labs—H. F. Dodge, H. G. Romig, and W. Shewhart—developed statistical procedures for sampling and quality control. In 1935, L.H.C. Tippett conducted studies that provided the groundwork for statistical sampling theory.

At first, these quantitative models were not widely used in industry. However, the onset of World War II changed that. The war generated tremendous pressures on manufacturing output, and specialists from many disciplines combined efforts to achieve advancements in the military and in manufacturing. After the war, efforts to develop and refine quantitative tools for decision making continued, resulting in decision models for forecasting, inventory management, project management, and other areas of operations management.

During the 1960s and 1970s, management science techniques were highly regarded; in the 1980s, they lost some favor. However, the widespread use of personal computers and user-friendly software in the workplace contributed to a resurgence in the popularity of these techniques.

The Influence of Japanese Manufacturers

A number of Japanese manufacturers developed or refined management practices that increased the productivity of their operations and the quality of their products, due in part to the influence of Americans W. Edwards Deming and Joseph Juran. This made them

TABLE 1.5

Historical summary of operations management

Approximate Date	Contribution/Concept	Originator
1776	Division of labor	Adam Smith
1790	Interchangeable parts	Eli Whitney
1911	Principles of scientific management	Frederick W. Taylor
1911	Motion study, use of industrial psychology	Frank and Lillian Gilbreth
1912	Chart for scheduling activities	Henry Gantt
1913	Moving assembly line	Henry Ford
1915	Mathematical model for inventory ordering	F. W. Harris
1930	Hawthorne studies on worker motivation	Elton Mayo
1935	Statistical procedures for sampling and quality control	H. F. Dodge, H. G. Romig, W. Shewhart, L.H.C. Tippett
1940	Operations research applications in warfare	Operations research groups
1947	Linear programming	George Dantzig
1951	Commercial digital computers	Sperry Univac, IBM
1950s	Automation	Numerous
1960s	Extensive development of quantitative tools	Numerous
1960s	Industrial dynamics	Jay Forrester
1975	Emphasis on manufacturing strategy	W. Skinner
1980s	Emphasis on flexibility, time-based competition, lean production	T. Ohno, S. Shingo, Toyota
1980s	Emphasis on quality	W. Edwards Deming, J. Juran, K. Ishikawa
1990s	Internet, supply chain management	Numerous
2000s	Applications service providers and outsourcing	Numerous
	Social media, YouTube, and others	Numerous

very competitive, sparking interest in their approaches by companies outside Japan. Their approaches emphasized quality and continual improvement, worker teams and empowerment, and achieving customer satisfaction. The Japanese can be credited with spawning the “quality revolution” that occurred in industrialized countries, and with generating widespread interest in lean production.

The influence of the Japanese on U.S. manufacturing and service companies has been enormous and promises to continue for the foreseeable future. Because of that influence, this book will provide considerable information about Japanese methods and successes.

Table 1.5 provides a chronological summary of some of the key developments in the evolution of operations management.

1.9 OPERATIONS TODAY

LO1.9 Describe current issues in business that impact operations management.

Advances in information technology and global competition have had a major influence on operations management. While the *internet* offers great potential for business organizations, the potential, as well as the risks, must be clearly understood in order to determine if and how to exploit this potential. In many cases, the internet has altered the way companies compete in the marketplace.

Electronic business, or **e-business**, involves the use of the internet to transact business. E-business is changing the way business organizations interact with their customers and their

E-business The use of electronic technology to facilitate business transactions.

suppliers. Most familiar to the general public is **e-commerce**, consumer–business transactions, such as buying online or requesting information. However, business-to-business transactions such as e-procurement represent an increasing share of e-business. E-business is receiving increased attention from business owners and managers in developing strategies, planning, and decision making.

The word **technology** has several definitions, depending on the context. Generally, *technology* refers to the application of scientific knowledge to the development and improvement of goods and services. It can involve knowledge, materials, methods, and equipment. The term *high technology* refers to the most advanced and developed machines and methods. Operations management is primarily concerned with three kinds of technology: product and service technology, process technology, and information technology (IT). All three can have a major impact on costs, productivity, and competitiveness.

Product and service technology refers to the discovery and development of new products and services. This is done mainly by researchers and engineers, who use the scientific approach to develop new knowledge and translate that into commercial applications.

Process technology refers to methods, procedures, and equipment used to produce goods and provide services. They include not only processes within an organization but also supply chain processes.

Information technology (IT) refers to the science and use of computers and other electronic equipment to store, process, and send information. Information technology is heavily ingrained in today’s business operations. This includes electronic data processing, the use of bar codes to identify and track goods, obtaining point-of-sale information, data transmission, the internet, e-commerce, e-mail, and more.

Management of technology is high on the list of major trends, and it promises to be high well into the future. For example, computers have had a tremendous impact on businesses in many ways, including new product and service features, process management, medical diagnosis, production planning and scheduling, data processing, and communication. Advances in materials, methods, and equipment also have had an impact on competition and productivity. Advances in information technology also have had a major impact on businesses. Obviously, there have been—and will continue to be—many benefits from technological advances. However, technological advance also places a burden on management. For example, management must keep abreast of changes and quickly assess both their benefits and risks. Predicting advances can be tricky at best, and new technologies often carry a high price tag and usually a high cost to operate or repair. And in the case of computer operating systems, as new systems are introduced, support for older versions is discontinued, making periodic upgrades necessary. Conflicting technologies can exist that make technological choices even more difficult. Technological innovations in both *products* and *processes* will continue to change the way businesses operate, and hence require continuing attention.

The General Agreement on Tariffs and Trade (GATT) of 1994 reduced tariffs and subsidies in many countries, expanding world trade. However, new tariffs in 2018 and 2019, some temporary, have had an impact on the strategies and operations of businesses large and small around the world. One effect is the importance business organizations are giving to management of their supply chains.

Globalization and the need for global supply chains have broadened the scope of supply chain management. However, tightened border security in certain instances and new tariffs have added challenges and uncertainties to managing supply chain operations. In some instances, organizations are reassessing their use of offshore outsourcing.

Competitive pressures and changing economic conditions have caused business organizations to put more emphasis on operations strategy, working with fewer resources, revenue management, process analysis and improvement, quality improvement, agility, and lean production.

During the latter part of the 1900s, many companies neglected to include *operations strategy* in their corporate strategy. Some of them paid dearly for that neglect. Now, more and

E-commerce Consumer-to-business transactions.

Technology The application of scientific discoveries to the development and improvement of products and services and operations processes.



There is a huge demand in the United States and elsewhere for affordable women's clothing. Low-cost clothing retailers such as Spain's Zara and Sweden's H&M are benefiting from their ability to quickly get mass-produced, trendy new fashions to store shelves while some less-agile competitors, like Macy's and Gap, struggle to achieve the same results. A key factor for the agile retailers is their nearness to low-cost producers in Romania and Turkey, which greatly shortens transportation time. American retailers often source from China, but increasing wages there and the

longer distance lessen their ability to take advantage of quickly introducing new low-cost fashions.

Question

What possible solutions do you see for competitors such as Macy's and Gap?

Source: Based on Roya Wolverson, "Need for Speed: Glamorizing Cheap Fashion Costs More than You Think," *Time*, August 6, 2012, p. 18.

more companies are recognizing the importance of operations strategy on the overall success of their business, as well as the necessity for relating it to their overall business strategy.

Working with fewer resources due to layoffs, corporate downsizing, and general cost cutting is forcing managers to make trade-off decisions on resource allocation, and to place increased emphasis on cost control and productivity improvement.

Revenue management is a method used by some companies to maximize the revenue they receive from fixed operating capacity by influencing demand through price manipulation. Also known as yield management, it has been successfully used in the travel and tourism industries by airlines, cruise lines, hotels, amusement parks, and rental car companies, and in other industries such as trucking and public utilities.

Process analysis and improvement includes cost and time reduction, productivity improvement, process yield improvement, and quality improvement and increasing customer satisfaction. This is sometimes referred to as a **Six Sigma** process.

Six Sigma A process for reducing costs, improving quality, and increasing customer satisfaction.

Given a boost by the "quality revolution" of the 1980s and 1990s, *quality* is now ingrained in business. Some businesses use the term *total quality management (TQM)* to describe their quality efforts. A quality focus emphasizes *customer satisfaction* and often involves *teamwork*. *Process improvement* can result in improved quality, cost reduction, and *time reduction*. Time relates to costs and to competitive advantage, and businesses seek ways to reduce the time to bring new products and services to the marketplace to gain a competitive edge. If two companies can provide the same product at the same price and quality, but one can deliver it four weeks earlier than the other, the quicker company will invariably get the sale. Time reductions are being achieved in many companies now. Union Carbide was able to cut \$400 million of fixed expenses, and Bell Atlantic was able to cut the time needed to hook up long-distance carriers from 15 days to less than 1, at a savings of \$82 million.

Agility The ability of an organization to respond quickly to demands or opportunities.

Agility refers to the ability of an organization to respond quickly to demands or opportunities. It is a strategy that involves maintaining a flexible system that can quickly respond to changes in either the volume of demand or changes in product/service offerings. This is particularly important as organizations scramble to remain competitive and cope with increasingly shorter product life cycles and strive to achieve shorter development times for new or improved products and services.

Lean production, a new approach to production, emerged in the 1990s. It incorporates a number of the recent trends listed here, with an emphasis on quality, flexibility, time reduction, and teamwork. This has led to a *flattening* of the organizational structure, with fewer levels of management.

Lean system System that uses minimal amounts of resources to produce a high volume of high-quality goods with some variety.

Lean systems are so named because they use much less of certain resources than typical mass production systems use—space, inventory, and workers—to produce a comparable amount of output. Lean systems use a highly skilled workforce and flexible equipment. In effect, they incorporate advantages of both mass production (high volume, low unit cost) and craft production (variety and flexibility). Quality is also higher than in mass production. This approach has now spread to services, including health care, offices, and shipping and delivery.

The skilled workers in lean production systems are more involved in maintaining and improving the system than their mass production counterparts. They are taught to stop an operation if they discover a defect, and to work with other employees to find and correct the

cause of the defect so that it won't recur. This results in an increasing level of quality over time and eliminates the need to inspect and rework at the end of the line.

Because lean production systems operate with lower amounts of inventory, additional emphasis is placed on anticipating when problems might occur *before* they arise and avoiding those problems through planning. Even so, problems can still occur at times, and quick resolution is important. Workers participate in both the planning and correction stages.

Compared to workers in traditional systems, much more is expected of workers in lean production systems. They must be able to function in teams, playing active roles in operating and improving the system. Individual creativity is much less important than team success. Responsibilities also are much greater, which can lead to pressure and anxiety not present in traditional systems. Moreover, a flatter organizational structure means career paths are not as steep in lean production organizations. Workers tend to become generalists rather than specialists, another contrast to more traditional organizations.

1.10 KEY ISSUES FOR TODAY'S BUSINESS OPERATIONS

There are a number of issues that are high priorities of many business organizations. Although not every business is faced with these issues, many are. Chief among the issues are the following.

Economic conditions. Trade disputes and tariffs have created uncertainties for decision makers.

Innovating. Finding new or improved products or services are only two of the many possibilities that can provide value to an organization. Innovations can be made in processes, the use of the internet, or the supply chain that reduce costs, increase productivity, expand markets, or improve customer service.

Quality problems. The numerous operations failures mentioned at the beginning of the chapter underscore the need to improve the way operations are managed. That relates to product design and testing, oversight of suppliers, risk assessment, and timely response to potential problems.

Risk management. The need for managing risk is underscored by recent events that include financial crises, product recalls, accidents, natural and man-made disasters, and economic ups and downs. Managing risks starts with identifying risks, assessing vulnerability and potential damage (liability costs, reputation, demand), and taking steps to reduce or share risks.

Cyber-security. The need to guard against intrusions from hackers whose goal is to steal personal information of employees and customers is becoming increasingly necessary. Moreover, interconnected systems increase intrusion risks in the form of industrial espionage.

Competing in a global economy. Low labor costs in third-world countries have increased pressure to reduce labor costs. Companies must carefully weigh their options, which include outsourcing some or all of their operations to low-wage areas, reducing costs internally, changing designs, and working to improve productivity.

Three other key areas require more in-depth discussion: environmental concerns, ethical conduct, and managing the supply chain.

Environmental Concerns

Concern about global warming and pollution has had an increasing effect on how businesses operate.

Stricter environmental regulations, particularly in developed nations, are being imposed. Furthermore, business organizations are coming under increasing pressure to reduce their carbon footprint (the amount of carbon dioxide generated by their operations and their supply chains) and to generally operate sustainable processes. **Sustainability** refers to service

Sustainability Using resources in ways that do not harm ecological systems that support human existence.



BY LISA SPENCER

Hershey's "Cocoa for Good" initiative promises to spend \$500 million dollars through 2030 to promote sustainable cocoa sourcing. This move should sweeten its image with consumers and help improve productivity of small farmers in Ghana and the Ivory Coast, the source of about 70 percent of the world's cocoa supply. Last year, Hershey's bought more than 75 percent of its cocoa from certified and sustainable sources, and it plans to increase that to 100 percent in the next few years.¹

Hershey's holistic strategy for West Africa includes four distinct goals: providing nutritious food to children, eliminating child labor, economically empowering women, and working with farmers to increase productivity with shade-grown cocoa and other farming techniques. Shade-grown cocoa plants can be productive for up to 15 years longer than plants grown in full sun. By teaching small farmers to grow cocoa more efficiently, Hershey's can help them increase yields without further encroachment on forested areas.

Six months into the program, Hershey's daily provides 50,000 Ghanaian school children with Vivi packets, a vitamin-rich nut-paste snack. Other milestones include helping 9,000 West African farmers to improve their business skills, building five schools, and supporting 31 other educational facilities.²

More and more consumers prefer to do business with companies that practice sustainable sourcing of supplies and the ethical treatment of workers. In addition, leadership in many companies also hold these same values themselves. Thus, from an operations standpoint, having a low-cost strategy may take a back seat to one which includes sustainable crop production and the ethical treatment of workers.

Questions

1. Why are companies like Hershey's engaging in sustainability initiatives such as this?
2. How might Hershey's actions affect others in the supply chain? How might they affect competitors or customers?

Based on:

¹ "Hershey to Spend \$500 Million Making More Sustainable Kisses," Marvin G. Perez and Emily Chasen, *Bloomberg*, April 3, 2018, <https://www.bloomberg.com/news/articles/2018-04-03/hershey-to-invest-500-million-in-making-more-sustainable-kisses>.

² "Hershey's Cocoa for Good Program Already Making an Impact in West Africa," Anthony Myers, November 5, 2018, <https://www.confectionerynews.com/Article/2018/11/05/Hershey-s-Cocoa-for-Good-program-already-making-an-impact-in-West-Africa>.

and production processes that use resources in ways that do not harm ecological systems that support both current and future human existence. Sustainability measures often go beyond traditional environmental and economic measures to include measures that incorporate social criteria in decision making.

All areas of business will be affected by this. Areas that will be most affected include product and service design, consumer education programs, disaster preparation and response, supply chain

Puma's "Clever Little Bag" changes the idea of the shoebox by wrapping footwear in a cardboard structure with 65 percent less cardboard. It uses a bag made of recycled plastic as the outer layer that holds the inner cardboard structure together. Puma expects to cut carbon dioxide emissions by 10,000 tons per year and water, energy, and diesel use by 60 percent by using fewer materials—8,500 fewer tons of paper to be specific—and the new packaging's lighter weight.



nicostock/Shutterstock



DIET AND THE ENVIRONMENT: VEGETARIAN VS. NONVEGETARIAN

It is interesting to examine the environmental impact of dietary choices. There's ample evidence that agricultural practices pollute the soil, air, and water. Factors range from the distance food travels to get to the consumer, to the amount of water and fertilizer used. Of particular concern is the environmental impact of a diet high in animal protein. The Food and Agricultural Organization (FAO) of the United Nations recently reported that livestock production is one of the major causes of global warming and air and water pollution. Using a methodology that considers the entire supply chain, the FAO estimated that livestock accounts for 18 percent of greenhouse gas emissions.

A Vegetarian vs. Nonvegetarian Diet and the Environment
The eco-friendliness of a meat eater's diet was the subject of

a study conducted by researchers from the Departments of Environmental Health and Nutrition of Loma Linda University in California. They compared the environmental effects of a vegetarian vs. nonvegetarian diet in California in terms of agricultural production inputs, including pesticides and fertilizers, water, and energy.

The study indicated that, in the combined production of 11 food items, the nonvegetarian diet required 2.9 times more water, 2.5 times more primary energy, 13 times more fertilizer, and 1.4 times more pesticides than the vegetarian diet. The greatest differences stemmed from including beef in the diet.

Source: Based on "Finding a Scientific Connection Between Food Choices and the Environment," *Environmental Nutrition Newsletter*, October 2009, p. 3.

waste management, and outsourcing decisions. Note that outsourcing of goods production increases not only transportation costs, but also fuel consumption and carbon released into the atmosphere. Consequently, sustainability thinking may have implications for outsourcing decisions.

Because they all fall within the realm of operations, operations management is central to dealing with these issues. Sometimes referred to as "green initiatives," the possibilities include reducing packaging, materials, water and energy use, and the environmental impact of the supply chain, including buying locally. Other possibilities include reconditioning used equipment (e.g., printers and copiers) for resale, and recycling.

The reading above suggests that even our choice of diet can affect the environment.

Ethical Conduct

The need for ethical conduct in business is becoming increasingly obvious, given numerous examples of questionable actions in recent history. In making decisions, managers must consider how their decisions will affect shareholders, management, employees, customers, the community at large, and the environment. Finding solutions that will be in the best interests of all of these stakeholders is not always easy, but it is a goal that all managers should strive to achieve. Furthermore, even managers with the best intentions will sometimes make mistakes. If mistakes do occur, managers should act responsibly to correct those mistakes as quickly as possible, and to address any negative consequences.

Many organizations have developed *codes of ethics* to guide employees' or members' conduct. **Ethics** is a standard of behavior that guides how one should act in various situations. The Markula Center for Applied Ethics at Santa Clara University identifies five principles for thinking ethically:

- The **Utilitarian Principle**: The good done by an action or inaction should outweigh any harm it causes or might cause. An example is not allowing a person who has had too much to drink to drive.
- The **Rights Principle**: Actions should respect and protect the moral rights of others. An example is not taking advantage of a vulnerable person.
- The **Fairness Principle**: Equals should be held to, or evaluated by, the same standards. An example is equal pay for equal work.
- The **Common Good Principle**: Actions should contribute to the common good of the community. An example is an ordinance on noise abatement.
- The **Virtue Principle**: Actions should be consistent with certain ideal virtues. Examples include honesty, compassion, generosity, tolerance, fidelity, integrity, and self-control.

The center expands these principles to create a framework for ethical conduct. An **ethical framework** is a sequence of steps intended to guide thinking and subsequent decisions or actions.

LO1.10 Explain the importance of ethical decision making.

Ethics A standard of behavior that guides how one should act in various situations.

Ethical framework A sequence of steps intended to guide thinking and subsequent decision or action.

The Fair Trade Certified™ label guarantees to consumers that strict economic, social, and environmental criteria were met in the production and trade of an agricultural product.



pixelliebe/Shutterstock

Here is the one developed by the Markula Center for Applied Ethics:

1. Recognize an ethical issue by asking if an action could be damaging to a group or an individual. Is there more to it than just what is legal?
2. Make sure the pertinent facts are known, such as who will be impacted, and what options are available.
3. Evaluate the options by referring to the appropriate preceding ethical principle.
4. Identify the “best” option and then further examine it by asking how someone you respect would view it.
5. In retrospect, consider the effect your decision had and what you can learn from it.

More detail is available at the Center’s website: <http://www.scu.edu/ethics/practicing/decision/framework.html>.

Operations managers, like all managers, have the responsibility to make ethical decisions. Ethical issues arise in many aspects of operations management, including:

- Financial statements: accurately representing the organization’s financial condition.
- Worker safety: providing adequate training, maintaining equipment in good working condition, maintaining a safe working environment.
- Product safety: providing products that minimize the risk of injury to users or damage to property or the environment.
- Quality: honoring warranties, avoiding hidden defects.
- The environment: not doing things that will harm the environment.
- The community: being a good neighbor.
- Hiring and firing workers: avoiding false pretenses (e.g., promising a long-term job when that is not what is intended).
- Closing facilities: taking into account the impact on a community, and honoring commitments that have been made.
- Workers’ rights: respecting workers’ rights, dealing with workers’ problems quickly and fairly.

The Ethisphere Institute recognizes companies worldwide for their ethical leadership. Here are some samples from their list:

Apparel: Gap

Automotive: Ford Motor Company

Business services: Paychex

Café: Starbucks

Computer hardware: Intel

Computer software: Adobe Systems, Microsoft

Consumer electronics: Texas Instruments, Xerox

E-commerce: eBay

General retail: Costco, Target

Groceries: Safeway, Wegmans, Whole Foods

Health and beauty: L'Oreal

Logistics: UPS

You can see a complete list of recent recipients and the selection criteria at Ethisphere.com.

The Need to Manage the Supply Chain

Supply chain management is being given increasing attention as business organizations face mounting pressure to improve management of their supply chains. In the past, most organizations did little to manage their supply chains. Instead, they tended to concentrate on their own operations and on their immediate suppliers. Moreover, the planning, marketing, production and inventory management functions in organizations in supply chains have often operated independently of each other. As a result, supply chains experienced a range of problems that were seemingly beyond the control of individual organizations. The problems included large oscillations of inventories, inventory stockouts, late deliveries, and quality problems. These and other issues now make it clear that management of supply chains is essential to business success. The other issues include the following:

1. **The need to improve operations.** Efforts on cost and time reduction, and productivity and quality improvement, have expanded in recent years to include the supply chain. Opportunity now lies largely with procurement, distribution, and logistics—the supply chain.
2. **Increasing levels of outsourcing.** Organizations are increasing their levels of **outsourcing**, buying goods or services instead of producing or providing them themselves. As outsourcing increases, some organizations are spending increasing amounts on supply-related activities (wrapping, packaging, moving, loading and unloading, and sorting). A significant amount of the cost and time spent on these and other related activities may be unnecessary. Issues with imported products, including tainted food products, toothpaste, and pet foods, as well as unsafe tires and toys, have led to questions of liability and the need for companies to take responsibility for monitoring the safety of outsourced goods.
3. **Increasing transportation costs.** Transportation costs are increasing, and they need to be more carefully managed.
4. **Competitive pressures.** Competitive pressures have led to an increasing number of new products, shorter product development cycles, and increased demand for customization. And in some industries, most notably consumer electronics, product life cycles are relatively short. Added to this are the adoption of quick-response strategies and efforts to reduce lead times.
5. **Increasing globalization.** Increasing globalization has expanded the physical length of supply chains. A global supply chain increases the challenges of managing a supply chain. Having far-flung customers and/or suppliers means longer lead times and greater opportunities for disruption of deliveries. Often, currency

LO1.11 Explain the need to manage the supply chain.

Outsourcing Buying goods or services instead of producing or providing them in-house.

In Kachchh, India, Fair trade allows cotton farmers to have the assurance of a minimum price, which gives them more security to plan their business and invest in their communities.



age fotostock/Alamy Stock Photo

- differences and monetary fluctuations are factors, as well as language and cultural differences. Also, tightened border security in some instances has slowed shipments of goods.
6. **Increasing importance of e-business.** The increasing importance of e-business has added new dimensions to business buying and selling and has presented new challenges.
 7. **The complexity of supply chains.** Supply chains are complex; they are dynamic, and they have many inherent uncertainties that can adversely affect them, such as inaccurate forecasts, late deliveries, substandard quality, equipment breakdowns, and canceled or changed orders.
 8. **The need to manage inventories.** Inventories play a major role in the success or failure of a supply chain, so it is important to coordinate inventory levels throughout a supply chain. Shortages can severely disrupt the timely flow of work and have far-reaching impacts, while excess inventories add unnecessary costs. It would not be unusual to find inventory shortages in some parts of a supply chain and excess inventories in other parts of the same supply chain.
 9. **The need to deal with trade wars.** Trade wars can occur if a country objects to its trade imbalance with another country. This can result in tariffs and retaliatory tariffs, causing changes in cost structures. Uncertainty about how long and to what degree tariffs will be in place can greatly increase pressure on companies that have global supply chains.

Elements of Supply Chain Management

Supply chain management involves coordinating activities across the supply chain. Central to this is taking customer demand and translating it into corresponding activities at each level of the supply chain.

The key elements of supply chain management are listed in Table 1.6. The first element, customers, is the driving element. Typically, marketing is responsible for determining what customers want, as well as forecasting the quantities and timing of customer demand. Product and service design must match customer wants with operations capabilities.

Processing occurs in each component of the supply chain: It is the core of each organization. The major portion of processing occurs in the organization that produces the product or service for the final customer (the organization that assembles the computer, services the car, etc.). A major aspect of this for both the internal and external portions of a supply chain is scheduling.

Inventory is a staple in most supply chains. Balance is the main objective; too little causes delays and disrupts schedules, but too much adds unnecessary costs and limits flexibility.

TABLE 1.6
Elements of supply chain management

Element	Typical Issues	Chapter(s)
Customers	Determining what products and/or services customers want	3, 4
Forecasting	Predicting the quantity and timing of customer demand	3
Design	Incorporating customers, wants, manufacturability, and time to market	4
Capacity planning	Matching supply and demand	5, 11
Processing	Controlling quality, scheduling work	10, 16
Inventory	Meeting demand requirements while managing the costs of holding inventory	12, 13, 14
Purchasing	Evaluating potential suppliers, supporting the needs of operations on purchased goods and services	15
Suppliers	Monitoring supplier quality, on-time delivery, and flexibility; maintaining supplier relations	15
Location	Determining the location of facilities	8
Logistics	Deciding how to best move information and materials	15

Purchasing is the link between an organization and its suppliers. It is responsible for obtaining goods and/or services that will be used to produce products or provide services for the organization's customers. Purchasing selects suppliers, negotiates contracts, establishes alliances, and acts as a liaison between suppliers and various internal departments.

The supply portion of a value chain is made up of one or more suppliers, all links in the chain, and each one capable of having an impact on the effectiveness—or the ineffectiveness—of the supply chain. Moreover, it is essential that the planning and execution be carefully coordinated between suppliers and all members of the demand portion of their chains.

Location can be a factor in a number of ways. Where suppliers are located can be important, as can the location of processing facilities. Nearness to market, nearness to sources of supply, or nearness to both may be critical. Also, delivery time and cost are usually affected by location.

Two types of decisions are relevant to supply chain management—strategic and operational. The strategic decisions are the design and policy decisions. The operational decisions relate to day-to-day activities: managing the flow of material and product and other aspects of the supply chain in accordance with strategic decisions.

The major decision areas in supply chain management are location, production, distribution, and inventory. The *location* decision relates to the choice of locations for both production and distribution facilities. Production and transportation costs and delivery lead times are important. *Production* and *distribution* decisions focus on what customers want, when they want it, and how much is needed. Outsourcing can be a consideration. Distribution decisions are strongly influenced by transportation cost and delivery times, because transportation costs often represent a significant portion of total cost. Moreover, shipping alternatives are closely tied to production and inventory decisions. For example, using air transport means higher costs but faster deliveries and less inventory in transit than sea, rail, or trucking options. Distribution decisions must also take into account capacity and quality issues. Operational decisions focus on scheduling, maintaining equipment, and meeting customer demand. Quality control and workload balancing are also important considerations. *Inventory* decisions relate to determining inventory needs and coordinating production and stocking decisions throughout the supply chain. Logistics management plays the key role in inventory decisions.

Enterprise Resource Planning (ERP) is being increasingly used to provide information sharing in real time among organizations and their major supply chain partners. This important topic is discussed in more detail in Chapter 13.

Operations Tours

Throughout the book you will discover operations tours that describe operations in all sorts of companies. The tour below is of Wegmans Food Markets, a major regional supermarket chain. Wegmans has been consistently ranked high on *Fortune* magazine's list of the 100 Best Companies to Work For since the inception of the survey a decade ago.

OPERATIONS TOUR



WEGMANS FOOD MARKETS

Wegmans Food Markets, Inc., is one of the premier grocery chains in the United States. Headquartered in Rochester, New York, Wegmans operates about 100 stores, mainly in Rochester, Buffalo, and Syracuse. There are also a handful of stores elsewhere in New York State, as well as in New Jersey, Massachusetts, North Carolina,

Pennsylvania, and Virginia. The company employs over 45,000 people, and has annual sales of over \$3 billion.

Wegmans has a strong reputation for offering its customers high product quality and excellent service. Through a combination of market research, trial and error, and listening to its customers,

(continued)

(concluded)

Wegmans has evolved into a very successful organization. Its sales per square foot are 50 percent higher than the industry average.

Superstores

Many of the company's stores are giant 100,000-square-foot superstores, double or triple the size of average supermarkets. You can get an idea about the size of these stores from this: They usually have between 25 and 35 checkout lanes, and during busy periods, all of the checkouts are in operation. A superstore typically employs from 500 to 600 people.

Individual stores differ somewhat in terms of actual size and some special features. Aside from the features normally found in supermarkets, they generally have a full-service deli (typically a 40-foot display case), a 500-square-foot fisherman's wharf that has perhaps 10 different fresh fish offerings most days, a large bakery section (each store bakes its own bread, rolls, cakes, pies, and pastries), and extra-large produce sections. They also offer a complete pharmacy, a card shop, and an Olde World Cheese section. In-store floral shops range in size up to 800 square feet of floor space and offer a wide variety of fresh-cut flowers, flower arrangements, vases, and plants. In-store card shops cover over 1,000 square feet of floor space. The bulk foods department provides customers with the opportunity to select the quantities they desire from a vast array of foodstuffs and some nonfood items such as birdseed and pet food.

Each store is a little different. Some stores feature a Market Café that has different food stations, each devoted to preparing and serving a certain type of food. For example, one station will have pizza and other Italian specialties, another will have Asian food, and still another chicken or fish. There will also be a sandwich bar, a salad bar, and a dessert station.

Customers often wander among stations as they decide what to order. In some Market Cafés, diners can have wine with their meals and have brunch on Sundays. In most locations, customers can stop in on their way home from work and choose from a selection of freshly prepared dinner entrees such as medallions of beef with herb butter, chicken marsala, stuffed flank steak with mushrooms, Cajun tuna, crab cakes, and side dishes such as roasted red potatoes, grilled vegetables, and Caesar salad. Many Wegmans stores offer ready-made sandwiches, as well as made-to-order sandwiches. Some stores have a coffee-shop section with tables and chairs where shoppers can enjoy regular or specialty coffees and a variety of tempting pastries.

Produce Department

The company prides itself on fresh produce, which is replenished as often as 12 times a day. Its larger stores have produce sections that are four to five times the size of a produce section in an average supermarket. Wegmans offers locally grown produce in season, and uses a "farm to market" system whereby some local growers deliver their produce directly to individual stores, bypassing the main warehouse. This reduces the company's inventory holding costs and gets the produce into the stores as quickly as possible. Growers may use specially designed containers that

go right onto the store floor instead of large bins. This avoids the bruising that often occurs when fruits and vegetables are transferred from bins to display shelves, and reduces the labor needed to transfer the produce to shelves.

Meat Department

In addition to large display cases of both fresh and frozen meat products, many stores have a full-service butcher shop that offers a variety of fresh meat products and where butchers are available to provide customized cuts of meat for customers.

Meat department employees attend Wegmans' "Meat University," where they learn about different cuts of meat and how to best prepare them. They also learn about other items to pair with various meats, and suggest side dishes, breads, and wine. This helps instill a "selling culture" among employees, who often spend 75 percent of their time talking with customers.

Wegmans continually analyzes store operations to improve processes. In the meat department, a change from in-store cutting and traditional packaging to using a centralized meat processing facility and vacuum packaging extended the shelf life of meats and reduced staffing requirements in meat departments, reducing costs and providing customers with an improved product.

Ordering

Each department handles its own ordering. Although sales records are available from records of items scanned at the checkouts, they are not used directly for replenishing stock. Other factors—such as pricing, special promotions, and local circumstances (e.g., festivals, weather conditions)—must all be taken into account. However, for seasonal periods, such as holidays, managers often check scanner records to learn what past demand was during a comparable period.

The superstores typically receive one truckload of goods per day from the main warehouse. During peak periods, a store may receive two truckloads from the main warehouse. The short lead time greatly reduces the length of time an item might be out of stock, unless the main warehouse is also out of stock.



tarheel1776/Shutterstock

The company exercises strict control over suppliers, insisting on product quality and on-time deliveries.

Inventory Management

Some stores carry as many as 70,000 individual units. Wegmans uses a companywide system to keep track of inventory. Departments take a monthly inventory count to verify the amount shown in the companywide system. Departments receive a periodic report indicating how many days of inventory the department has on hand. Having an appropriate amount on hand is important to department managers: If they have too much inventory on hand, that will add to their department's costs, whereas having too little inventory will result in shortages and thus lost sales and dissatisfied customers.

Employees

The company recognizes the value of good employees. It typically invests an average of \$7,000 to train each new employee. In addition to learning about store operations, new employees learn the importance of good customer service and how to provide it. The employees are helpful, cheerfully answering customer questions or handling complaints. Employees are motivated through a combination of compensation, profit sharing, and benefits. Employee turnover for full-time workers is about 6 percent, compared to the industry average of about 20 percent.

Quality

Quality and customer satisfaction are utmost in the minds of Wegmans' management and its employees. Private-label food items, as well as name brands, are regularly evaluated in test kitchens, along with potential new products. Managers are responsible for checking and maintaining product and service quality in their departments. Moreover, employees are encouraged to report problems to their managers.

If a customer is dissatisfied with an item, and returns it, or even a portion of the item, the customer is offered a choice of

a replacement or a refund. If the item is a Wegmans brand food item, it is then sent to the test kitchen to determine the cause of the problem. If the cause can be determined, corrective action is taken.

Technology

Wegmans continues to adopt new technologies to maintain its competitive edge, including new approaches to tracking inventory and managing its supply chain, and new ways to maintain freshness in the meat and produce departments.

Sustainability

Wegmans replaced incandescent light bulbs with compact fluorescent bulbs, generating 3,000 fewer tons of carbon dioxide each year. Also, the company installed sensors in its dairy cases that reduced the time the cooling systems run by 50 percent.

Questions

1. How do customers judge the quality of a supermarket?
2. Indicate how and why each of these factors is important to the successful operation of a supermarket:
 - a. Customer satisfaction
 - b. Forecasting
 - c. Capacity planning
 - d. Location
 - e. Inventory management
 - f. Layout of the store
 - g. Scheduling
3. What are some of the ways Wegmans uses technology to gain an edge over its competition?



Suzanne Kreiter/The Boston Globe/Getty Images

Wegmans' Patisserie is an authentic French pastry shop.



Mark Gail/The Washington Post/Getty Images

Wegmans' chefs prepare ready-to-eat entrees, side dishes, salads, sandwiches, and ready-to-heat entrees.

SUMMARY

The operations function in business organizations is responsible for producing goods and providing services. It is a core function of every business. Supply chains are the sequential system of suppliers and customers that begins with basic sources of inputs and ends with final customers of the system. Operations and supply chains are interdependent—one couldn't exist without the other, and no business organization could exist without both.

Operations management involves system design and operating decisions related to product and service design, capacity planning, process selection, location selection, work management, inventory and supply management, production planning, quality assurance, scheduling, and project management.

The historical evolution of operations management provides interesting background information on the continuing evolution of this core business function.

The Operations Tours and Readings included in this and subsequent chapters provide insights into actual business operations.

KEY POINTS

1. The operations function is that part of every business organization that produces products and/or delivers services.
2. Operations consists of processes that convert inputs into outputs. Failure to manage those processes effectively will have a negative impact on the organization.
3. Organizations are systems made up of interrelated subsystems. Because of this, a systems perspective in decision making is essential.
4. A key goal of business organizations is to achieve an economic matching of supply and demand. The operations function is responsible for providing the supply or service capacity for expected demand.
5. All processes exhibit variation that must be managed.
6. Although there are some basic differences between services and products that must be taken into account from a managerial standpoint, there are also many similarities between the two.
7. Environmental issues will increasingly impact operations decision making.
8. Ethical behavior is an integral part of good management practice.
9. All business organizations have, and are part of, a supply chain that must be managed.

KEY TERMS

agility, 26	interchangeable parts, 22	process, 13
craft production, 21	lead time, 11	services, 4
division of labor, 23	lean systems, 26	Six Sigma, 26
e-business, 24	mass production, 22	supply chain, 4
e-commerce, 25	model, 18	sustainability, 27
ethical framework, 29	operations management, 4	system, 20
ethics, 29	outsourcing, 31	technology, 25
goods, 4	Pareto phenomenon, 20	value-added, 6

DISCUSSION AND REVIEW QUESTIONS

1. Briefly describe the terms *operations management* and *supply chain*.
2. Identify the three major functional areas of business organizations and briefly describe how they interrelate.
3. Describe the operations function and the nature of the operations manager's job.
4. List five important differences between goods production and service operations; then list five important similarities.
5. Briefly discuss each of these terms related to the historical evolution of operations management:
 - a. Industrial Revolution
 - b. Scientific management
 - c. Interchangeable parts
 - d. Division of labor
6. Why are services important? Why is manufacturing important? What are nonmanufactured goods?

7. What are models and why are they important?
8. Why is the degree of customization an important consideration in process planning?
9. List the trade-offs you would consider for each of these decisions:
 - a. Driving your own car versus public transportation.
 - b. Buying a computer now versus waiting for an improved model.
 - c. Buying a new car versus buying a used car.
 - d. Speaking up in class versus waiting to get called on by the instructor.
 - e. A small business owner having a website versus newspaper advertising.
10. Describe each of these systems: craft production, mass production, and lean production.
11. Why might some workers prefer not to work in a lean production environment?
12. Discuss the importance of each of the following:
 - a. Matching supply and demand
 - b. Managing a supply chain
13. List and briefly explain the four basic sources of variation, and explain why it is important for managers to be able to effectively deal with variation.
14. Why do people do things that are unethical?
15. Explain the term *value-added*.
16. Discuss the various impacts of outsourcing.
17. Discuss the term *sustainability*, and its relevance for business organizations.

This item appears at the end of each chapter. It is intended to focus your attention on three key issues for business organizations in general, and operations management in particular. Those issues are trade-off decisions, collaboration among various functional areas of the organization, and the impact of technology. You will see three or more questions relating to these issues. Here is the first set of questions:

1. What are trade-offs? Why is careful consideration of trade-offs important in decision making?
2. Why is it important for the various functional areas of a business organization to collaborate?
3. In what general ways does technology have an impact on operations management decision making?

This item also will appear in every chapter. It allows you to critically apply information you learned in the chapter to a practical situation. Here is the first set of exercises:

1. Many organizations offer a combination of goods and services to their customers. As you learned in this chapter, there are some key differences between the production of goods and the delivery of services. What are the implications of these differences relative to managing operations?
2. Why is it important to match supply and demand? If a manager believes that supply and demand will not be equal, what actions could the manager take to increase the probability of achieving a match?
3. One way that organizations compete is through technological innovation. However, there can be downsides for both the organization and the consumer. Explain.
4. What ethical considerations are important in development of technology in general, as well as AI (artificial intelligence)?
5.
 - a. What would cause a businessperson to make an unethical decision?
 - b. What are the risks of doing so?

TAKING STOCK

CRITICAL THINKING EXERCISES



Hazel had worked for the same *Fortune* 500 company for almost 15 years. Although the company had gone through some tough times, things were starting to turn around. Customer orders were up, and quality and productivity had improved dramatically from what they had been only a few years earlier due to a company-wide quality improvement program. So it came as a real shock to Hazel and about 400 of her coworkers when they were suddenly terminated following the new CEO's decision to downsize the company.

After recovering from the initial shock, Hazel tried to find employment elsewhere. Despite her efforts, after eight months of searching she was no closer to finding a job than the day she started. Her funds were being depleted and she was getting more discouraged. There was one bright spot, though: She was able to bring in a little money by mowing lawns for her neighbors. She got involved quite by chance when she heard one neighbor remark that now that his children were on their own, nobody was around to cut the grass. Almost jokingly, Hazel asked him how much he'd be willing to pay. Soon Hazel was mowing the lawns of five neighbors. Other neighbors wanted her to work on their lawns, but she didn't feel that she could spare any more time from her job search.

However, as the rejection letters began to pile up, Hazel knew she had to make a decision. On a sunny Tuesday morning, she decided, like many others in a similar situation, to go into business for herself—taking care of neighborhood lawns. She was relieved to give up the stress of job hunting, and she was excited about the prospect of being her own boss. But she was also fearful of being completely on her own. Nevertheless, Hazel was determined to make a go of it.

At first, business was a little slow, but once people realized Hazel was available, many asked her to take care of their lawns. Some people were simply glad to turn the work over to her; others switched from professional lawn care services. By the end of her first year in business, Hazel knew she could earn a living this way. She also performed other services such as fertilizing lawns, weeding gardens, and trimming shrubbery. Business became so good that Hazel hired two part-time workers to assist her and, even then, she believed she could expand further if she wanted to.

QUESTIONS

- Hazel is the operations manager of her business. Among her responsibilities are forecasting, inventory management, scheduling, quality assurance, and maintenance.
 - What kinds of things would likely require forecasts?
 - What inventory items does Hazel probably have? Name one inventory decision she has to make periodically.
 - What scheduling must she do? What things might occur to disrupt schedules and cause Hazel to reschedule?
 - How important is quality assurance to Hazel's business? Explain.
 - What kinds of maintenance must be performed?
- In what ways are Hazel's customers most likely to judge the quality of her lawn care services?
- What are some of the trade-offs that Hazel probably considered relative to:
 - Working for a company instead of for herself?
 - Expanding the business?
 - Launching a website?
- The town is considering an ordinance that would prohibit putting grass clippings at the curb for pickup because local landfills cannot handle the volume. What options might Hazel consider if the ordinance is passed? Name two advantages and two drawbacks of each option.
- Hazel decided to offer the students who worked for her a bonus of \$25 for ideas on how to improve the business, and they provided several good ideas. One idea that she initially rejected now appears to hold great promise. The student who proposed the idea has left, and is currently working for a competitor. Should Hazel send that student a check for the idea? What are the possible trade-offs?
- All managers have to cope with variation.
 - What are the major sources of variation that Hazel has to contend with?
 - How might these sources of variation impact Hazel's ability to match supply and demand?
 - What are some ways she can cope with variation?
- Hazel is thinking of making some of her operations sustainable. What are some ideas she might consider?

SELECTED BIBLIOGRAPHY AND FURTHER READINGS

Bloomberg Businessweek

Bowie, Norman E., ed. *The Blackwell Guide to Business Ethics*. Malden, MA: Blackwell, 2002.

Fitzsimmons, James, and Mona Fitzsimmons. *Service Management*, 4th ed. New York: McGraw-Hill/Irwin, 2011.

Fortune magazine

Wisner, Joel D., and Linda L. Stanley. *Process Management: Creating Value Along the Supply Chain*. Mason, OH: Thomson South-Western, 2008.

Womack, James P., Daniel Jones, and Daniel Roos. *The Machine that Changed the World*. New York: Harper Perennial, 1991, 2007.

PROBLEM-SOLVING GUIDE

Here is a procedure that will help you solve most of the end-of-chapter problems in this book and on exams:

1. Identify the question to be answered. This is critical.
2. Summarize the information given in the problem statement using the appropriate symbols.
3. Determine what type of problem it is so you can select the appropriate problem-solving tools such as a formula or table. Check your notes from class, chapter examples, and the Solved Problems section of the chapter, and any preceding chapter problems you have already solved for guidance.
4. Solve the problem and be sure to indicate your answer.

Department A can produce parts at a rate of 50/day. Department B uses those parts at a rate of 10/day. Each day unused parts are added to inventory. At what rate does the inventory of unused parts build up?

Example 1

1. The question to be answered: At what rate does inventory of unused parts build up (i.e., increase) per day?
2. The given information: Production rate = 50 parts/day
Usage rate = 10 parts/day
3. For this simple problem, no formula or table is needed. Inventory buildup is simply the difference between the production and usage rates.
4. Production rate = 50 parts/day
Usage rate = 10 parts/day
Inventory buildup = 40 parts/day

Solution

Companies often use this formula to determine how much of a certain item to order:

$$Q = \sqrt{\frac{2DS}{H}}$$

where

- Q = order quantity
- D = annual demand
- S = ordering cost
- H = annual holding cost per unit

If annual demand is 400 units, ordering cost is \$36, and annual holding cost is \$2 per unit, what is the order quantity?

Example 2

1. The question to be answered: What is the order quantity, Q ?
2. The information given in the problem: $D = 400$ units/year, $S = \$36$, $H = \$2$ per year
3. To solve the problem, substitute the values given in the problem into the formula.
4. Solution:

$$Q = \sqrt{\frac{2(400 \text{ units/yr.})\$36}{\$2/\text{unit/yr.}}} = 120 \text{ units}$$

Solution

Problem-Solving Template
Problem number:
The question to be answered:
Information given:
Solve using:
Solution:

2

CHAPTER

Competitiveness, Strategy, and Productivity

LEARNING OBJECTIVES

After completing this chapter, you should be able to:

- LO2.1** List several ways that business organizations compete.
- LO2.2** Name several reasons that business organizations fail.
- LO2.3** Define the terms *mission* and *strategy* and explain why they are important.
- LO2.4** Discuss and compare organization strategy and operations strategy and explain why it is important to link the two.
- LO2.5** Describe and give examples of time-based strategies.
- LO2.6** Define the term *productivity* and explain why it is important to organizations and to countries.
- LO2.7** Describe several factors that affect productivity.

CHAPTER OUTLINE

- | | | |
|--|--|--|
| 2.1 Introduction 42 | 2.5 Implications of Organization Strategy for Operations Management 54 | Cases: Home-Style Cookies 67
Hazel Revisited 68
"Your Garden Gloves" 69
Girlfriend Collective 69 |
| 2.2 Competitiveness 42
Why Some Organizations Fail 43 | 2.6 Transforming Strategy into Action: The Balanced Scorecard 54 | Operations Tour: The U.S.
Postal Service 70 |
| 2.3 Mission and Strategies 44
Strategies and Tactics 45
Strategy Formulation 47
Supply Chain Strategy 50
Sustainability Strategy 50
Global Strategy 51 | 2.7 Productivity 56
Computing Productivity 57
Productivity in the Service Sector 59
Factors that Affect Productivity 60
Improving Productivity 61 | |
| 2.4 Operations Strategy 51
Strategic Operations
Management Decision Areas 52
Quality and Time Strategies 52 | | |



IgorPHOTOseag/Shutterstock

THE COLD HARD FACTS

The name of the game is competition. The playing field is global. Those who understand how to play the game will succeed; those who don't are doomed to failure. And don't think the game is just companies competing with each other. In companies that have multiple factories or divisions producing the same good or service, factories or divisions sometimes find themselves competing with each other. When a competitor—another company or a sister factory or division in the same company—can turn out products better, cheaper, and faster, that spells real trouble for the factory or division that is performing at a lower level. The trouble can be layoffs or even a shutdown if the managers can't turn things around. The bottom line? Better quality, higher productivity, lower costs, and the ability to quickly respond to customer needs are more important than ever, and the bar is getting higher. Business organizations need to develop solid strategies for dealing with these issues.

This chapter discusses competitiveness, strategy, and productivity—three separate but related topics that are vitally important to business organizations. *Competitiveness* relates to the effectiveness of an organization in the marketplace relative to other organizations that offer similar products or services. Operations and marketing have a major impact on competitiveness. *Strategy* relates to the plans that determine how an organization pursues its goals. Operations strategy is particularly important in this regard. *Productivity* relates to the effective use of resources and has a direct impact on competitiveness. Operations management is chiefly responsible for productivity.

2.1 INTRODUCTION

In this chapter, you will learn about the different ways companies compete and why some firms do a very good job of competing. You will learn how effective strategies can lead to competitive organizations, as well as what productivity is, why it is important, and what organizations can do to improve it.

LO2.1 List several ways that business organizations compete.

Competitiveness How effectively an organization meets the wants and needs of customers relative to others that offer similar goods or services.

2.2 COMPETITIVENESS

Companies must be competitive to sell their goods and services in the marketplace. **Competitiveness** is an important factor in determining whether a company prospers, barely gets by, or fails. Business organizations compete through some combination of price, delivery time, and product or service differentiation.

Marketing influences competitiveness in several ways, including identifying consumer wants and needs, pricing, and advertising and promotion.

1. **Identifying consumer wants and/or needs** is a basic input in an organization's decision-making process, and central to competitiveness. The ideal is to achieve a perfect match between those wants and needs and the organization's goods and/or services.
2. **Price and quality** are key factors in consumer buying decisions. It is important to understand the trade-off decision consumers make between price and quality.
3. **Advertising and promotion** are ways organizations can inform potential customers about features of their products or services, and attract buyers.

Operations has a major influence on competitiveness through product and service design, cost, location, quality, response time, flexibility, inventory and supply chain management, and service. Many of these are interrelated.

1. **Product and service design** should reflect joint efforts of many areas of the firm to achieve a match between financial resources, operations capabilities, supply chain capabilities, and consumer wants and needs. Special characteristics or features of a product or service can be a key factor in consumer buying decisions. Other key factors include **innovation** and the **time-to-market** for new products and services.
2. **Cost** of an organization's output is a key variable that affects pricing decisions and profits. Cost-reduction efforts are generally ongoing in business organizations. **Productivity** (discussed later in the chapter) is an important determinant of cost. Organizations with higher productivity rates than their competitors have a competitive cost advantage. A company may outsource a portion of its operation to achieve lower costs, higher productivity, or better quality.
3. **Location** can be important in terms of cost and convenience for customers. Location near inputs can result in lower input costs. Location near markets can result in lower transportation costs and quicker delivery times. Convenient location is particularly important in the retail sector.
4. **Quality** refers to materials, workmanship, design, and service. Consumers judge quality in terms of how well they think a product or service will satisfy its intended purpose. Customers are generally willing to pay more for a product or service if they perceive the product or service has a higher quality than that of a competitor.
5. **Quick response** can be a competitive advantage. One way is quickly bringing new or improved products or services to the market. Another is being able to quickly deliver existing products and services to a customer after they are ordered, and still another is quickly handling customer complaints.
6. **Flexibility** is the ability to respond to changes. Changes might relate to alterations in design features of a product or service, or to the volume demanded by customers, or the



Terry Vine/Blend Images/Getty Images

Indian operators take calls at Quatro call center in Gurgaon on the outskirts of New Delhi. Companies take advantage of communications and software support offshore to drive down costs. This industry in India already provides over one million jobs.

mix of products or services offered by an organization. High flexibility can be a competitive advantage in a changeable environment.

7. **Inventory management** can be a competitive advantage by effectively matching supplies of goods with demand.
8. **Supply chain management** involves coordinating internal and external operations (buyers and suppliers) to achieve timely and cost-effective delivery of goods throughout the system.
9. **Service** might involve after-sale activities customers perceive as value-added, such as delivery, setup, warranty work, and technical support. Or it might involve extra attention while work is in progress, such as courtesy, keeping the customer informed, and attention to details. **Service quality** can be a key differentiator; and it is one that is often sustainable. Moreover, businesses rated highly by their customers for service quality tend to be more profitable, and grow faster, than businesses that are not rated highly.
10. **Managers** and **workers** are the people at the heart and soul of an organization, and if they are competent and motivated, they can provide a distinct competitive edge via their skills and the ideas they create. One often overlooked skill is answering the telephone. How complaint calls or requests for information are handled can be a positive or a negative. If a person answering is rude or not helpful, that can produce a negative image. Conversely, if calls are handled promptly and cheerfully, that can produce a positive image and, potentially, a competitive advantage.

Why Some Organizations Fail

Organizations fail, or perform poorly, for a variety of reasons. Being aware of those reasons can help managers avoid making similar mistakes. Among the chief reasons are the following:

1. Neglecting operations strategy.
2. Failing to take advantage of strengths and opportunities, and/or failing to recognize competitive threats.
3. Putting too much emphasis on short-term financial performance at the expense of research and development.
4. Placing too much emphasis on product and service design and not enough on process design and improvement.

LO2.2 Name several reasons that business organizations fail.

5. Neglecting investments in capital and human resources.
6. Failing to establish good internal communications and cooperation among different functional areas.
7. Failing to consider customer wants and needs.

The key to successfully competing is to determine what customers want and then directing efforts toward meeting (or even exceeding) customer expectations. Two basic issues must be addressed. First: What do the customers want? (Which items on the preceding list of the ways business organizations compete are important to customers?) Second: What is the best way to satisfy those wants?

Operations must work with marketing to obtain information on the relative importance of the various items to each major customer or target market.

Understanding competitive issues can help managers develop successful strategies.

2.3 MISSION AND STRATEGIES

LO2.3 Define the terms *mission* and *strategy* and explain why they are important.

Mission The reason for the existence of an organization.

Mission statement States the purpose of an organization.

Goals Provide detail and scope of the mission.

Strategies Plans for achieving organizational goals.

An organization’s **mission** is the reason for its existence. It is expressed in its **mission statement**. For a business organization, the mission statement should answer the question “What business are we in?” Missions vary from organization to organization, depending on the nature of their business. Table 2.1 provides several examples of mission statements.

A mission statement serves as the basis for organizational **goals**, which provide more detail and describe the scope of the mission. The mission and goals often relate to how an organization wants to be perceived by the general public, and by its employees, suppliers, and customers. Goals serve as a foundation for the development of organizational strategies. These, in turn, provide the basis for strategies and tactics of the functional units of the organization.

Organizational strategy is important because it guides the organization by providing direction for, and alignment of, the goals and **strategies** of the functional units. Moreover, strategies can be the main reason for the success or failure of an organization.

There are three basic business strategies:

- Low cost
- Responsiveness
- Differentiation from competitors

IS IT A STRATEGIC, TACTICAL, OR OPERATIONAL ISSUE?

Sometimes the same issue may apply to all three levels. However, a key difference is the time frame. From a strategic perspective, long-term implications are most relevant. From

tactical and operational perspectives, the time frames are much shorter. In fact, the operational time frame is often measured in days.

Responsiveness relates to the ability to respond to changing demands. Differentiation can relate to product or service features, quality, reputation, or customer service. Some organizations focus on a single strategy, while others employ a combination of strategies. One company that has multiple strategies is Amazon.com. Not only does it offer low-cost and quick, reliable deliveries, it also excels in customer service.

TABLE 2.1
Selected portions of company mission statements

Microsoft	To help people and businesses throughout the world to realize their full potential.
Verizon	To help people and businesses communicate with each other.
Starbucks	To inspire and nurture the human spirit—one cup and one neighborhood at a time.
U.S. Dept. of Education	To promote student achievement and preparation for global competitiveness and fostering educational excellence and ensuring equal access.



Amazon received the 4th spot in customer service in a *Forbes* ranking in 2018. Although most Amazon customers never talk with an employee, when something goes wrong, Amazon excels in dealing with the problem. In one case, when a New Jersey woman received a workbook she ordered that was described as “like new,” she was surprised to discover that it wasn’t even close to new—worksheets had already been filled in. She complained to the merchant but didn’t get a response. Then, she complained

to Amazon. She promptly received a refund, even though she had paid the merchant, not Amazon.

And she wasn’t asked to return the book.

Amazon sees its customer service as a way to enhance customer experience, and as a way to identify potential problems with merchants. In fact, if merchants have problems with more than 1 percent of their orders, that can get them removed from the site.

Source: *Forbes*, July 2018.



SWNS/Alamy Stock Photo

Amazon’s service helped propel the company to a double-digit sales increase. Amazon started same-day shipping in major cities, launched a program to urge manufacturers to drop frustrating packaging, and extended its service reach by acquiring free-shipping pioneer Zappos.com.

Strategies and Tactics

If you think of goals as destinations, then strategies are the roadmaps for reaching those destinations. Strategies provide *focus* for decision making. Generally speaking, organizations have overall strategies called *organizational strategies*, which relate to the entire organization. They also have *functional strategies*, which relate to each of the functional areas of the organization. The functional strategies should support the overall strategies of the organization, just as the organizational strategies should support the goals and mission of the organization.

Tactics are the methods and actions used to accomplish strategies. They are more specific than strategies, and they provide guidance and direction for carrying out actual *operations*, which need the most specific and detailed plans and decision making in an organization. You might think of tactics as the “how to” part of the process (e.g., how to reach the destination, following the strategy roadmap), and operations as the actual “doing” part of the process. Much of this book deals with tactical operations.

It should be apparent that the overall relationship that exists from the mission down to actual operations is *hierarchical*. This is illustrated in Figure 2.1.

A simple example may help to put this hierarchy into perspective.

Rita is a high school student in Southern California. She would like to have a career in business, have a good job, and earn enough income to live comfortably.

A possible scenario for achieving her goals might look something like this:

Mission: Live a good life.

Goal: Successful career, good income.

Strategy: Obtain a college education.

Tactics: Select a college and a major; decide how to finance college.

Operations: Register, buy books, take courses, study.

EXAMPLE 1

FIGURE 2.1

Planning and decision making are hierarchical in organizations

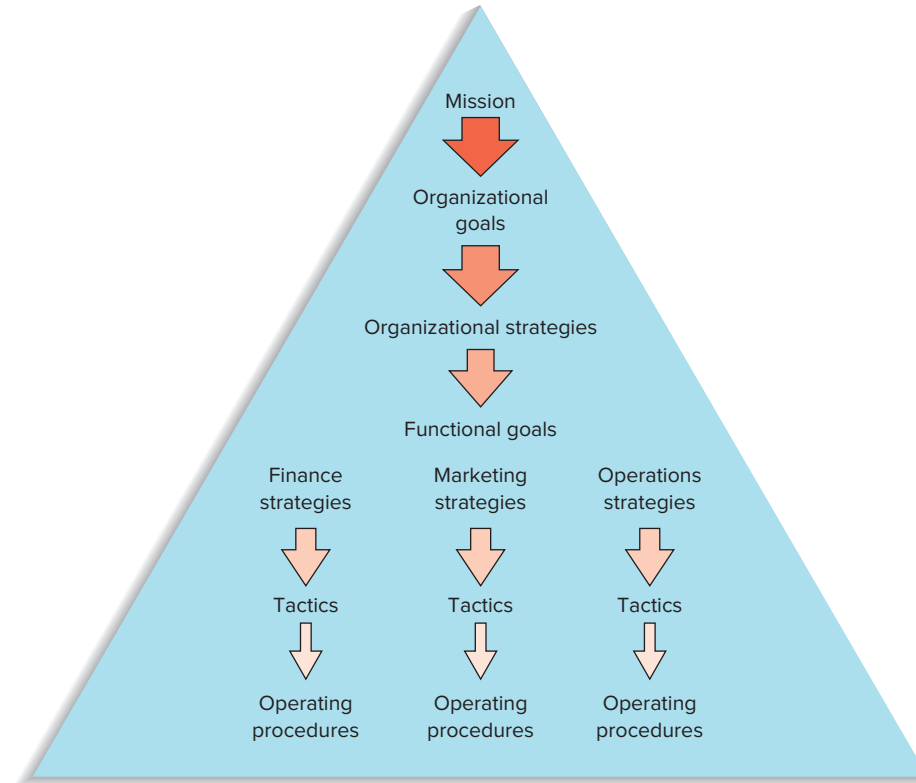

Here are some examples of different strategies an organization might choose from:

Low cost. Outsource operations to third-world countries that have low labor costs.

Scale-based strategies. Use capital-intensive methods to achieve high output volume and low unit costs.

Specialization. Focus on narrow product lines or limited service to achieve higher quality.

Newness. Focus on innovation to create new products or services.

Flexible operations. Focus on quick response and/or customization.

High quality. Focus on achieving higher quality than competitors.

Service. Focus on various aspects of service (e.g., helpful, courteous, reliable, etc.).

Sustainability. Focus on environmental-friendly and energy-efficient operations.

A wide range of business organizations are beginning to recognize the strategic advantages of sustainability, not only in economic terms, but also through promotional benefits by publicizing their sustainability efforts and achievements.

Sometimes, organizations will combine two or more of these, or other approaches, into their strategy. However, unless they are careful, they risk losing focus and not achieving advantage in any category. Generally speaking, strategy formulation takes into account the way organizations compete and a particular organization's assessment of its own strengths and weaknesses in order to take advantage of its **core competencies**—those special attributes or abilities possessed by an organization that give it a *competitive edge*.

The most effective organizations use an approach that develops core competencies based on customer needs, as well as on what the competition is doing. Marketing and operations work closely to match customer needs with operations capabilities. Competitor competencies are important for several reasons. For example, if a competitor is able to supply high-quality products, it may be necessary to meet that high quality as a baseline. However, merely *matching* a competitor is usually not sufficient to gain market share. It may be necessary to exceed the quality level of the competitor or gain an edge by excelling in one or more other dimensions, such as rapid delivery or service after the sale. Walmart, for example, has been very successful in managing its supply chain, which has contributed to its competitive advantage.

Core competencies The special attributes or abilities that give an organization a competitive edge.

Organization Strategy	Operations Strategy	Examples of Companies or Services
Low price	Low cost	U.S. first-class postage Walmart Southwest Airlines
Responsiveness	Short processing time	McDonald's restaurants Express Mail, UPS, FedEx Uber, Lyft, Grubhub
	On-time delivery	Domino's Pizza FedEx
Differentiation: High quality	High-performance design and/or high-quality processing Consistent quality	TV: Sony, Samsung, LG Lexus Disneyland Five-star restaurants or hotels Coca-Cola, PepsiCo Wegmans Electrical power
Differentiation: Newness	Innovation	3M, Apple Google
Differentiation: Variety	Flexibility	Burger King ("Have it your way") Hospital emergency room
	Volume	McDonald's ("Buses welcome") Toyota Supermarkets (additional checkouts)
Differentiation: Service	Superior customer service	Disneyland Amazon IBM Nordstrom, Von Maur
Differentiation: Location	Convenience	Supermarkets, dry cleaners Mall stores Service stations Banks, ATMs

TABLE 2.2
Examples of operations strategies

To be effective, strategies and core competencies need to be aligned. Table 2.2 lists examples of strategies and companies that have successfully employed those strategies.

Strategy Formulation

Strategy formulation is almost always critical to the success of a strategy. Walmart discovered this when it opened stores in Japan. Although Walmart thrived in many countries on its reputation for low-cost items, Japanese consumers associated low cost with low quality, causing Walmart to rethink its strategy in the Japanese market. And many felt that Hewlett-Packard (HP) committed a strategic error when it acquired Compaq Computers at a cost of \$19 billion. HP's share of the computer market was less after the merger than the sum of the shares of the separate companies before the merger. In another example, U.S. automakers adopted a strategy in the early 2000s of offering discounts and rebates on a range of cars and SUVs, many of which were on low-margin vehicles. The strategy put a strain on profits, but customers began to expect those incentives, and the companies maintained them to keep from losing additional market share.

On the other hand, Coach, the maker of leather handbags and purses, successfully changed its longtime strategy to grow its market by creating new products. Long known for its highly durable leather goods in a market where women typically owned few handbags, Coach created a new market for itself by changing women's view of handbags by promoting "different handbags for different occasions" such as party bags, totes, clutches, wristlets, overnight bags, purses, and day bags. And Coach introduced many fashion styles and colors.

To formulate an effective strategy, senior managers must take into account the core competencies of the organizations, and they must *scan the environment*. They must determine

SWOT Analysis of strengths, weaknesses, opportunities, and threats.

Order qualifiers Characteristics that customers perceive as minimum standards of acceptability to be considered as a potential for purchase.

Order winners Characteristics of an organization's goods or services that cause it to be perceived as better than the competition.

Environmental scanning The monitoring of events and trends that present threats or opportunities for a company.

what competitors are doing, or planning to do, and take that into account. They must critically examine other factors that could have either positive or negative effects. This is sometimes referred to as the **SWOT** analysis (strengths, weaknesses, opportunities, and threats). Strengths and weaknesses have an internal focus and are typically evaluated by operations people. Threats and opportunities have an external focus and are typically evaluated by marketing people. SWOT is often regarded as the link between organizational strategy and operations strategy.

An alternative to SWOT analysis is Michael Porter's five forces model,¹ which takes into account the threat of new competition, the threat of substitute products or services, the bargaining power of customers, the bargaining power of suppliers, and the intensity of competition.

In formulating a successful strategy, organizations must take into account both order qualifiers and order winners. **Order qualifiers** are those characteristics that potential customers perceive as minimum standards of acceptability for a product to be considered for purchase. However, that may not be sufficient to get a potential customer to purchase from the organization. **Order winners** are those characteristics of an organization's goods or services that cause them to be perceived as better than the competition.

Characteristics such as price, delivery reliability, delivery speed, and quality can be order qualifiers or order winners. Thus, quality may be an order winner in some situations, but in others only an order qualifier. Over time, a characteristic that was once an order winner may become an order qualifier.

Obviously, it is important to determine the set of order qualifier characteristics and the set of order winner characteristics. It is also necessary to decide on the relative importance of each characteristic so that appropriate attention can be given to the various characteristics. Marketing must make that determination and communicate it to operations.

Environmental scanning is the monitoring of events and trends that present either threats or opportunities for the organization. Generally, these include competitors' activities; changing consumer needs; legal, economic, political, and environmental issues; the potential for new markets; and the like.

Another key factor to consider when developing strategies is technological change, which can present real opportunities and threats to an organization. Technological changes occur in products (high-definition TV, improved computer chips, improved cellular telephone systems, and improved designs for earthquake-proof structures); in services (faster order processing, faster delivery); and in processes (robotics, automation, computer-assisted processing, point-of-sale scanners, and flexible manufacturing systems). The obvious benefit is a competitive edge; the risk is that incorrect choices, poor execution, and higher-than-expected operating costs will create competitive *disadvantages*.

Important factors may be internal or external. The following are key external factors:

1. **Economic conditions.** These include the general health and direction of the economy, inflation and deflation, interest rates, tax laws, and tariffs.
2. **Political conditions.** These include favorable or unfavorable attitudes toward business, political stability or instability, and wars.
3. **Legal environment.** This includes antitrust laws, government regulations, trade restrictions, minimum wage laws, product liability laws and recent court experience, labor laws, and patents.
4. **Technology.** This can include the rate at which product innovations are occurring, current and future process technology (equipment, materials handling), and design technology.
5. **Competition.** This includes the number and strength of competitors, the basis of competition (price, quality, special features), and the ease of market entry.
6. **Customers.** Loyalty, existing relationships, and understanding of wants and needs are important.

¹Michael E. Porter, "The Five Competitive Forces that Shape Strategy," *Harvard Business Review* 86, no. 1 (January 2008), pp. 78–93, 137.

7. **Suppliers.** Supplier relationships, dependability of suppliers, quality, flexibility, and service are typical considerations.
8. **Markets.** This includes size, location, brand loyalties, ease of entry, potential for growth, long-term stability, and demographics.

The organization also must take into account various *internal factors* that relate to possible strengths or weaknesses. Among the key internal factors are the following:

1. **Human resources.** These include the skills and abilities of managers and workers, special talents (creativity, designing, problem solving), loyalty to the organization, expertise, dedication, and experience.
2. **Facilities and equipment.** Capacities, location, age, and cost to maintain or replace can have a significant impact on operations.
3. **Financial resources.** Cash flow, access to additional funding, existing debt burden, and cost of capital are important considerations.
4. **Products and services.** These include existing products and services, and the potential for new products and services.
5. **Technology.** This includes existing technology, the ability to integrate new technology, and the probable impact of technology on current and future operations.
6. **Other.** Other factors include patents, labor relations, company or product image, distribution channels, relationships with distributors, maintenance of facilities and equipment, access to resources, and access to markets.

After assessing internal and external factors and an organization's distinctive competence, a strategy or strategies must be formulated that will give the organization the best chance of success. Among the types of questions that may need to be addressed are the following:

What role, if any, will the internet play?

Will the organization have a global presence?

To what extent will *outsourcing* be used?

What will the supply chain management strategy be?

To what extent will new products or services be introduced?

What rate of growth is desirable and *sustainable*?

What emphasis, if any, should be placed on lean production?

How will the organization differentiate its products and/or services from competitors'?

The organization may decide to have a single, dominant strategy (e.g., be the price leader) or have multiple strategies. A single strategy would allow the organization to concentrate on one particular strength or market condition. On the other hand, multiple strategies may be needed to address a particular set of conditions.

Many companies are increasing their use of outsourcing to reduce overhead, gain flexibility, and take advantage of suppliers' expertise. Amazon provides a great example of some of the potential benefits of outsourcing as part of a business strategy.

Growth is often a component of strategy, especially for new companies. A key aspect of this strategy is the need to seek a growth rate that is sustainable. In the 1990s, fast-food company Boston Market dazzled investors and fast-food consumers alike. Fueled by its success, it undertook rapid expansion. By the end of the decade, the company was nearly bankrupt; it had overexpanded. In 2000, it was absorbed by fast-food giant McDonald's.

Companies increase their risk of failure not only by missing or incomplete strategies; they also fail due to poor execution of strategies. And sometimes they fail due to factors beyond their control, such as natural or man-made disasters, major political or economic changes, or competitors that have an overwhelming advantage (e.g., deep pockets, very low labor costs, less rigorous environmental requirements).

A useful resource on successful business strategies is the Profit Impact of Market Strategy (PIMS) database (www.pimsonline.com). The database contains profiles of over



LOW INVENTORY CAN INCREASE AGILITY

In 1984, Michael Dell, then a college student, started selling personal computers from his dorm room. He didn't have the resources to make computer components, so he let others do that, choosing instead to concentrate on selling the computers. And, unlike the major computer producers, he didn't sell to dealers. Instead, he sold directly to PC buyers, eliminating some intermediaries, which allowed for lower cost and faster delivery. Although direct selling of PCs is fairly commonplace now, in those days it was a major departure from the norm.

What did Dell do that was so different from the big guys? To start, he bought components from suppliers instead of making them. That gave him tremendous leverage. He had little inventory, no R&D expenditures, and relatively few employees. And the risks of this approach were spread among his suppliers. Suppliers were

willing to do this because Dell worked closely with them, and kept them informed. And because he was in direct contact with his customers, he gained tremendous insight into their expectations and needs, which he communicated to his suppliers.

Having little inventory gave Dell several advantages over his competitors. Aside from the lower costs of inventory, when new, faster computer chips became available, there was little inventory to work off, so he was able to offer the newer models much sooner than competitors with larger inventories. Also, when the prices of various components dropped, as they frequently did, he was able to take advantage of the lower prices, which kept his average costs lower than competitors' costs.

Today, the company is worth billions, and so is Michael Dell.

3,000 businesses located primarily in the United States, Canada, and western Europe. It is used by companies and academic institutions to guide strategic thinking. It allows subscribers to answer strategy questions about their business. Moreover, they can use it to generate benchmarks and develop successful strategies.

STRATEGY FORMULATION

The key steps in strategy formulation are:

1. Link strategy directly to the organization's mission or vision statement.
2. Assess strengths, weaknesses, threats, and opportunities, and identify core competencies.
3. Identify order winners and order qualifiers.
4. Select one or two strategies (e.g., low cost, speed, customer service) to focus on.

According to the PIMS website,

The *database* is a collection of statistically documented experiences drawn from thousands of businesses, designed to help understand what kinds of strategies (e.g., quality, pricing, vertical integration, innovation, advertising) work best in what kinds of business environments. The data constitute a key resource for such critical management tasks as evaluating business performance, analyzing new business opportunities, evaluating and reality testing new strategies, and screening business portfolios. *The primary role* of the PIMS Program of the Strategic Planning Institute is to help managers understand and react to their business environment. PIMS does this by assisting managers as they develop and test strategies that will achieve an acceptable level of winning as defined by various strategies and financial measures.

Source: <https://www.inc.com/encyclopedia/profit-impact-of-market-strategies-pims.html>

Supply Chain Strategy

A supply chain strategy specifies how the supply chain should function to achieve supply chain goals. The supply chain strategy should be aligned with the business strategy. If it is well executed, it can create value for the organization. It establishes how the organization should work with suppliers and policies relating to customer relationships and sustainability. Supply chain strategy is covered in more detail in a later chapter.

Sustainability Strategy

Society is placing increasing emphasis on corporate sustainability practices in the form of governmental regulations and interest groups. For these and other reasons, business organizations are or should be devoting attention to sustainability goals. To be successful, they will need a sustainability strategy. That requires elevating sustainability to the level of organizational

governance; formulating goals for products and services, for processes, and for the entire supply chain; measuring achievements and striving for improvements; and possibly linking executive compensation to the achievement of sustainability goals.

Global Strategy

Global strategies have two different aspects. One relates to where parts or products are made, or where services such as customer support are performed. The other relates to where products or service are sold. With wages and standards of living increases in countries such as China and India, new market opportunities present themselves, requiring well-thought out strategies to take advantage of those potential opportunities while minimizing any associated risks.

As globalization increased, many companies realized that strategic decisions with respect to globalization had to be made. One issue companies face today is that what works in one country or region does not necessarily work in another, and strategies must be carefully crafted to take these variabilities into account. Another issue is the threat of political or social upheaval. Still another issue is the difficulty of coordinating and managing far-flung operations. Indeed, “In today’s global markets, you don’t have to go abroad to experience international competition. Sooner or later the world comes to you.”²



Christopher Kerrigan/McGraw-Hill Education

At this McDonald's in Singapore, one variable is the use of rice as a staple of the Chinese diet. This ad highlights rice burgers.

2.4 OPERATIONS STRATEGY

The organization strategy provides the overall direction for the organization. It is broad in scope, covering the entire organization. **Operations strategy** is narrower in scope, dealing primarily with the operations aspect of the organization. Operations strategy relates to products, processes, methods, operating resources, quality, costs, lead times, and scheduling. Table 2.3 provides a comparison of an organization's mission, its overall strategy, and its operations strategy, tactics, and operations.

In order for operations strategy to be truly effective, it is important to link it to organization strategy; that is, the two should not be formulated independently. Rather, formulation of organization strategy should take into account the realities of operations' strengths and weaknesses,

LO2.4 Discuss and compare organization strategy and operations strategy and explain why it is important to link the two.

Operations strategy The approach, consistent with the organization strategy, that is used to guide the operations function.

²Christopher A. Bartlett and Sumantra Ghoshal, “Going Global: Lessons from Late Movers,” *Harvard Business Review*, March-April 2000, p. 139.

TABLE 2.3

Comparison of mission, organization strategy, and operations strategy

		Management Level	Time Horizon	Scope	Level of Detail	Relates to
The overall organization	Mission Strategy	Top	Long	Broad	Low	Survival, profitability
		Senior	Long	Broad	Low	Growth rate, market share
Operations	Strategic	Senior	Moderate to long	Broad	Low	Product design, choice of location, choice of technology, new facilities
	Tactical	Middle	Moderate	Moderate	Moderate	Employment levels, output levels, equipment selection, facility layout
	Operational	Low	Short	Narrow	High	Scheduling personnel, adjusting output rates, inventory management, purchasing

capitalizing on strengths and dealing with weaknesses. Similarly, operations strategy must be consistent with the overall strategy of the organization, and with the other functional units of the organization. This requires that senior managers work with functional units to formulate strategies that will support, rather than conflict with, each other and the overall strategy of the organization. As obvious as this may seem, it doesn't always happen in practice. Instead, we may find power struggles between various functional units. These struggles are detrimental to the organization because they pit functional units against each other rather than focusing their energy on making the organization more competitive and better able to serve the customer. Some of the latest approaches in organizations, involving teams of managers and workers, may reflect a growing awareness of the synergistic effects of working together rather than competing internally.

In the 1970s and early 1980s, operations strategy in the United States was often neglected in favor of marketing and financial strategies. That may have occurred because many chief executive officers did not come from operations backgrounds and perhaps did not fully appreciate the importance of the operations function. Mergers and acquisitions were common; leveraged buyouts were used, and conglomerates were formed that joined dissimilar operations. These did little to add value to the organization; they were purely financial in nature. Decisions were often made by individuals who were unfamiliar with the business, frequently to the detriment of that business. Meanwhile, foreign competitors began to fill the resulting vacuum with a careful focus on operations strategy.

In the late 1980s and early 1990s, many companies began to realize this approach was not working. They recognized that they were less competitive than other companies. This caused them to focus attention on operations strategy. A key element of both organization strategy and operations strategy is strategy formulation.

Operations strategy can have a major influence on the competitiveness of an organization. If it is well designed and well executed, there is a good chance the organization will be successful; if it is not well designed or executed, it is far less likely that the organization will be successful.

Strategic Operations Management Decision Areas

Operations management people play a strategic role in many strategic decisions in a business organization. Table 2.4 highlights some key decision areas. Notice that most of the decision areas have cost implications.

Two factors that tend to have universal strategic operations importance relate to quality and time. The following section discusses quality and time strategies.

Quality and Time Strategies

Traditional strategies of business organizations have tended to emphasize cost minimization or product differentiation. While not abandoning those strategies, many organizations have embraced strategies based on *quality* and/or *time*.

Quality-based strategies focus on maintaining or improving the quality of an organization's products or services. Quality is generally a factor in both attracting and retaining customers.

LO2.5 Describe and give examples of time-based strategies.

Quality-based strategies

Strategy that focuses on quality in all phases of an organization.

Decision Area	What the Decisions Affect
1. Product and service design	Costs, quality, liability, and environmental issues
2. Capacity	Cost structure, flexibility
3. Process selection and layout	Costs, flexibility, skill level needed, capacity
4. Work design	Quality of work life, employee safety, productivity
5. Location	Costs, visibility
6. Quality	Ability to meet or exceed customer expectations
7. Inventory	Costs, shortages
8. Maintenance	Costs, equipment reliability, productivity
9. Scheduling	Flexibility, efficiency
10. Supply chains	Costs, quality, agility, shortages, vendor relations
11. Projects	Costs, new products, services, or operating systems

TABLE 2.4
Strategic operations
management decisions

Quality-based strategies may be motivated by a variety of factors. They may reflect an effort to overcome an image of poor quality, a desire to catch up with the competition, a desire to maintain an existing image of high quality, or some combination of these and other factors. Interestingly enough, quality-based strategies can be part of another strategy such as cost reduction, increased productivity, or time, all of which benefit from higher quality.

Time-based strategies focus on reducing the time required to accomplish various activities (e.g., develop new products or services and market them, respond to a change in customer demand, or deliver a product or perform a service). By doing so, organizations seek to improve service to the customer and to gain a competitive advantage over rivals who take more time to accomplish the same tasks.

Time-based strategies
Strategies that focus on the reduction of time needed to accomplish tasks.

Time-based strategies focus on reducing the time needed to conduct the various activities in a process. The rationale is that by reducing time, costs are generally less, productivity is higher, quality tends to be higher, product innovations appear on the market sooner, and customer service is improved.

Organizations have achieved time reduction in some of the following:

Planning time: The time needed to react to a competitive threat, to develop strategies and select tactics, to approve proposed changes to facilities, to adopt new technologies, and so on.

Product/service design time: The time needed to develop and market new or redesigned products or services.

Processing time: The time needed to produce goods or provide services. This can involve scheduling, repairing equipment, methods used, inventories, quality, training, and the like.

Changeover time: The time needed to change from producing one type of product or service to another. This may involve new equipment settings and attachments, different methods, equipment, schedules, or materials.

Delivery time: The time needed to fill orders.

Response time for complaints: These might be customer complaints about quality, timing of deliveries, and incorrect shipments. These might also be complaints from employees about working conditions (e.g., safety, lighting, heat or cold), equipment problems, or quality problems.

It is essential for marketing and operations personnel to collaborate on strategy formulation in order to ensure that the buying criteria of the most important customers in each market segment are addressed.

Agile operations is a strategic approach for competitive advantage that emphasizes the use of flexibility to adapt and prosper in an environment of change. Agility involves a blending of several distinct competencies such as cost, quality, and reliability along with flexibility. Processing aspects of flexibility include quick equipment changeovers, scheduling, and innovation. Product or service aspects include varying output volumes and product mix.

Successful agile operations requires careful planning to achieve a system that includes people, flexible equipment, and information technology. Reducing the time needed to perform work is one of the ways an organization can improve a key metric: *productivity*.

2.5 IMPLICATIONS OF ORGANIZATION STRATEGY FOR OPERATIONS MANAGEMENT

Organization strategy has a major impact on operations and supply chain management strategies. For example, organizations that use a low-cost, high-volume strategy limit the amount of variety offered to customers. As a result, variations for operations and the supply chain are minimal, so they are easier to deal with. Conversely, a strategy to offer a wide variety of products or services, or to perform customized work, creates substantial operational and supply chain variations and, hence, more challenges in achieving a smooth flow of goods and services throughout the supply chain, thus making the matching of supply to demand more difficult. Similarly, increasing service reduces the ability to compete on price. Table 2.5 provides a brief overview of variety and some other key implications.

2.6 TRANSFORMING STRATEGY INTO ACTION: THE BALANCED SCORECARD

The Balanced Scorecard (BSC) is a top-down *management system* that organizations can use to clarify their vision and strategy and transform them into action. It was introduced in the early 1990s by Robert Kaplan and David Norton,³ and it has been revised and improved since then. The idea was to move away from a purely financial perspective of the organization and integrate other perspectives such as customers, internal business processes, and learning and growth. Using this approach, managers develop objectives, metrics, and targets for each objective and initiatives to achieve objectives, and they identify links among the various perspectives. Results are monitored and used to improve strategic performance results. Figure 2.2 illustrates the conceptual framework of this approach. Many organizations employ this or a similar approach.

TABLE 2.5

Organization strategies and their implications for operations management

Organization Strategy	Implications for Operations Management
Low price	Requires low variation in products/services and a high-volume, steady flow of goods results in maximum use of resources through the system. Standardized work, material, and inventory requirements.
High quality	Entails higher initial cost for product and service design, and process design, and more emphasis on assuring supplier quality.
Quick response	Requires flexibility, extra capacity, and higher levels of some inventory items.
Newness/innovation	Entails large investment in research and development for new or improved products and services plus the need to adapt operations and supply processes to suit new products or services.
Product or service variety	Requires high variation in resource and more emphasis on product and service design; higher worker skills needed, cost estimation more difficult; scheduling more complex; quality assurance more involved; inventory management more complex; and matching supply to demand more difficult.
Sustainability	Affects location planning, product and service design, process design, outsourcing decisions, returns policies, and waste management.

³Robert S. Kaplan and David P. Norton, *Balanced Scorecard: Translating Strategy into Action* (Cambridge, MA: Harvard Business School Press, 1996).

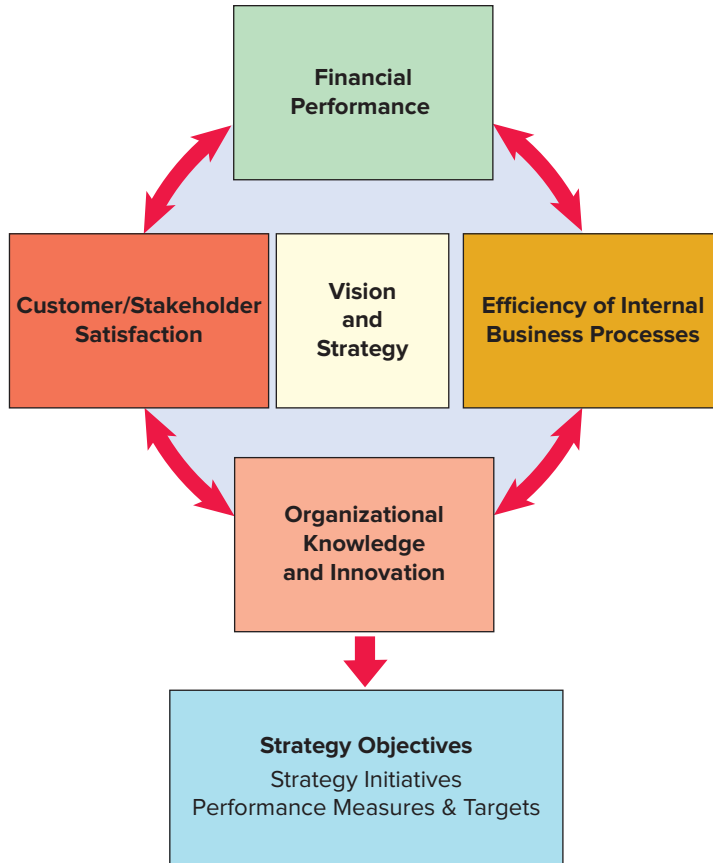

FIGURE 2.2
The Balanced Scorecard

Source: Adapted from Robert S. Kaplan and David P. Norton, "Using the Balanced Scorecard as a Strategic Management System," *Harvard Business Review* (January-February 1996): 76.

As seen in Figure 2.2, the four perspectives are intended to balance not only financial and nonfinancial performance, but also internal and external performance, as well as past and future performance. This approach can also help organizations focus on how they differ from the competition in each of the four areas if their vision is realized. Table 2.6 has some examples of factors for key focal points.

Although the Balanced Scorecard helps focus managers' attention on strategic issues and the implementation of strategy, it is important to note that it has no role in strategy formulation.

Focal Point	Factors
Suppliers	<ul style="list-style-type: none"> Delivery performance Quality performance Number of suppliers Supplier locations Duplicate activities
Internal Processes	<ul style="list-style-type: none"> Bottlenecks Automation potential Turnover
Employees	<ul style="list-style-type: none"> Job satisfaction Learning opportunities Delivery performance
Customers	<ul style="list-style-type: none"> Quality performance Satisfaction Retention rate

TABLE 2.6
Balanced scorecard factors examples

A major key to Apple's continued success is its ability to keep pushing the boundaries of innovation. Apple has demonstrated how to create growth by dreaming up products so new and ingenious that they have upended one industry after another.



Pieter Beens/Shutterstock

Moreover, this approach pays little attention to suppliers and government regulations, and community, environmental, and sustainability issues are missing. These are closely linked, and business organizations need to be aware of the impact they are having in these areas and respond accordingly. Otherwise, organizations may be subject to attack by pressure groups and risk damage to their reputation.

2.7 PRODUCTIVITY

LO2.6 Define the term *productivity* and explain why it is important to companies and to countries.

Productivity A measure of the effective use of resources, usually expressed as the ratio of output to input.

One of the primary responsibilities of a manager is to achieve *productive use* of an organization's resources. The term *productivity* is used to describe this. **Productivity** is an index that measures output (goods and services) relative to the input (labor, materials, energy, and other resources) used to produce it. It is usually expressed as the ratio of output to input:

$$\text{Productivity} = \frac{\text{Output}}{\text{Input}} \quad (2-1)$$

Although productivity is important for all business organizations, it is particularly important for organizations that use a strategy of low cost, because the higher the productivity, the lower the cost of the output.

A productivity ratio can be computed for a single operation, a department, an organization, or an entire country. In business organizations, productivity ratios are used for planning workforce requirements, scheduling equipment, financial analysis, and other important tasks.

Productivity has important implications for business organizations and for entire nations. For nonprofit organizations, higher productivity means lower costs; for profit-based organizations, productivity is an important factor in determining how competitive a company is. For a nation, the rate of *productivity growth* is of great importance. Productivity growth is the increase in productivity from one period to the next relative to the productivity in the preceding period. Thus,

$$\text{Productivity growth} = \frac{\text{Current productivity} - \text{Previous productivity}}{\text{Previous productivity}} \times 100 \quad (2-2)$$

For example, if productivity increased from 80 to 84, the growth rate would be

$$\frac{84 - 80}{80} \times 100 = 5\%$$

Productivity growth is a key factor in a country's rate of inflation and the standard of living of its people. Productivity increases add value to the economy while keeping inflation in check. Productivity growth was a major factor in the long period of sustained economic growth in the United States in the 1990s.

Computing Productivity

Productivity measures can be based on a single input (partial productivity), on more than one input (multi-factor productivity), or on all inputs (total productivity). Table 2.7 lists some examples of productivity measures. The choice of productivity measure depends primarily on the purpose of the measurement. If the purpose is to track improvements in labor productivity, then labor becomes the obvious input measure.

Partial measures are often of greatest use in operations management. Table 2.8 provides some examples of partial productivity measures.

The units of output used in productivity measures depend on the type of job performed. The following are examples of labor productivity:

$$\frac{\text{Yards of carpet installed}}{\text{Labor hours}} = \text{Yards of carpet installed per labor hour}$$

$$\frac{\text{Number of motel rooms cleaned}}{\text{Number of workers}} = \text{Number of motel rooms cleaned per worker}$$

Similar examples can be listed for *machine productivity* (e.g., the number of pieces per hour turned out by a machine).



Betastock/Shutterstock

Productivity can be enhanced by the use of robotic equipment. Robots can operate for long periods with consistent precision and high speed. The Hyundai Motor Company manufacturing plant in Montgomery, Alabama, uses robots for assembly work. This \$1.4 billion automotive plant is one of the most advanced assembly plants in North America.

Partial measures	$\frac{\text{Output}}{\text{Labor}}$	$\frac{\text{Output}}{\text{Machine}}$	$\frac{\text{Output}}{\text{Capital}}$	$\frac{\text{Output}}{\text{Energy}}$
Multifactor measures	$\frac{\text{Output}}{\text{Labor} + \text{Machine}}$		$\frac{\text{Output}}{\text{Labor} + \text{Capital} + \text{Energy}}$	
Total measure	$\frac{\text{Goods or services produced}}{\text{All inputs used to produce them}}$			

TABLE 2.7
Some examples of different types of productivity measures

TABLE 2.8

Some examples of partial productivity measures

Labor productivity	Units of output per labor hour Units of output per shift Value-added per labor hour Dollar value of output per labor hour
Machine productivity	Units of output per machine hour Dollar value of output per machine hour
Capital productivity	Units of output per dollar input Dollar value of output per dollar input
Energy productivity	Units of output per kilowatt-hour Dollar value of output per kilowatt-hour

EXAMPLE 2**Computing Productivity**

Determine the productivity for these cases:

- Four workers installed 720 square yards of carpeting in eight hours.
- A machine produced 70 pieces in two hours. However, two pieces were unusable.

SOLUTION

$$\begin{aligned}
 \text{a. Productivity} &= \frac{\text{Yards of carpet installed}}{\text{Labor hours worked}} \\
 &= \frac{720 \text{ square yards}}{4 \text{ workers} \times 8 \text{ hours/worker}} \\
 &= \frac{720 \text{ yards}}{32 \text{ hours}} \\
 &= 22.5 \text{ yards/hour}
 \end{aligned}$$

$$\begin{aligned}
 \text{b. Productivity} &= \frac{\text{Usable pieces}}{\text{Production time}} \\
 &= \frac{70 - 2 = 68 \text{ usable pieces}}{2 \text{ hours}} \\
 &= 34 \text{ pieces/hour}
 \end{aligned}$$

Calculations of multifactor productivity measure inputs and outputs using a common unit of measurement, such as cost. For instance, the measure might use cost of inputs and units of the output:

$$\frac{\text{Quantity of production}}{\text{Labor cost} + \text{Materials cost} + \text{Overhead}} \quad (2-3)$$

Note: The unit of measure must be the same for all factors in the denominator

EXAMPLE 3**Computing Multifactor Productivity**

Determine the multifactor productivity for the combined input of labor and machine time using the following data:

Output: 7,040 units

Input

Labor: \$1,000

Materials: \$520

Overhead: \$2,000

SOLUTION

$$\begin{aligned}
 \text{Multifactor productivity} &= \frac{\text{Output}}{\text{Labor} + \text{Materials} + \text{Overhead}} \\
 &= \frac{7,040 \text{ units}}{\$1,000 + \$520 + \$2,000} = 2 \text{ units per dollar input}
 \end{aligned}$$



It is sometimes easy to overlook the importance of productivity. National figures are often reported in the media. They may seem to be ho-hum; there's nothing glamorous about them to get our attention. But make no mistake; they are key economic indicators—barometers, if you will, that affect everybody. How? High productivity and high standard of living go hand-in-hand. If a country becomes more service-based, as the United States has become, if some (but not all) high-productivity manufacturing jobs are replaced by lower-productivity service jobs, that makes it more difficult to support a high standard of living.

Productivity gains can offset inflationary pressures related to wage increases. Productivity increases result in lower costs per unit. Those savings not only generate higher profits, they also help pay for wage increases.

Productivity levels are also important for industries and companies. For companies, a higher productivity relative to their competitors gives them a competitive advantage in the marketplace. With a higher productivity, they can afford to undercut competitors' prices to gain market share or charge the same prices but realize greater profits! For an industry, higher relative productivity means it is less likely to be supplanted by foreign industry.

Questions

1. Why is high productivity important for a nation?
2. Why do you suppose that service jobs have lower productivity than manufacturing jobs?
3. How can a company gain a competitive advantage by having higher productivity than its competitors have?

Productivity measures are useful on a number of levels. For an individual department or organization, productivity measures can be used to track performance *over time*. This allows managers to judge performance and to decide where improvements are needed. For example, if productivity has slipped in a certain area, operations staff can examine the factors used to compute productivity to determine what has changed and then devise a means of improving productivity in subsequent periods.

Productivity measures also can be used to judge the performance of an entire industry or the productivity of a country as a whole. These productivity measures are *aggregate* measures.

In essence, productivity measurements serve as scorecards of the effective use of resources. Business leaders are concerned with productivity as it relates to *competitiveness*: If two firms both have the same level of output but one requires less input because of higher productivity, that one will be able to charge a lower price and consequently increase its share of the market. Or that firm might elect to charge the same price, thereby reaping a greater profit. Government leaders are concerned with national productivity because of the close relationship between productivity and a nation's standard of living. High levels of productivity are largely responsible for the relatively high standards of living enjoyed by people in industrial nations. Furthermore, wage and price increases not accompanied by productivity increases tend to create inflationary pressures on a nation's economy.

Advantages of domestic-based operations for domestic markets often include higher worker productivity, better control of quality, avoidance of intellectual property losses, lower shipping costs, political stability, low inflation, and faster delivery.

Productivity in the Service Sector

Service productivity is more problematic than manufacturing productivity. In many situations, it is more difficult to measure, and thus to manage, because it involves intellectual activities and a high degree of variability. Think about medical diagnoses, surgery, consulting, legal services, customer service, and computer repair work. This makes productivity improvements more difficult to achieve. Nonetheless, because service is becoming an increasingly large portion of our economy, the issues related to service productivity will have to be dealt with. It is interesting to note that government statistics normally do not include service firms.



DUTCH TOMATO GROWERS' PRODUCTIVITY ADVANTAGE

Tomato growers in the Netherlands have a huge productivity advantage over their competitors in Italy and Greece. Although those countries are sun drenched while the Netherlands are anything but, computerized, climate-controlled greenhouses, and a “soil” spun from basalt and chalk that resembles cotton candy, allows for precise control of humidity and nutrition, and enables growers to produce their crops year round. Growers in Italy and Greece generally grow their crops outdoors or in unheated greenhouses, and can only manage two crops a year. Dutch growers are able to achieve yields that are about ten times per square yard of those of Italian and Greek growers. And the Dutch have a supply chain advantage: an integrated Dutch trading company works closely with supermarket chains in Europe and suppliers around the world, so farmers are able to sell their output in high volume,

rather than locally the way many farmers in other countries do. That enables Dutch growers to more closely match supply with supermarket demand. Finally, the Dutch tomato has been engineered to achieve a firmness that allows growers to harvest and ship tomatoes at their peak, while the “outdoor” farmers typically need to harvest their tomatoes before they are fully ripe to allow for firmness during shipping.

Questions

1. What factors enable Dutch tomato growers to achieve much higher productivity than the Italian and Greek growers?
2. Discuss the importance of the Dutch growers' supply chain.

Source: Based on “Tomato,” *Time*, March 25, 2013, pp. 9–14.

A useful measure closely related to productivity is *process yield*. Where products are involved, process yield is defined as the ratio of output of good product (i.e., defective product is not included) to the quantity of raw material input. Where services are involved, process yield measurement is often dependent on the particular process. For example, in a car rental agency, a measure of yield is the ratio of cars rented to cars available for a given day. In education, a measure for college and university admission yield is the ratio of student acceptances to the total number of students approved for admission. For subscription services, yield is the ratio of new subscriptions to the number of calls made or the number of letters mailed. However, not all services lend themselves to a simple yield measurement. For example, services such as automotive, appliance, and computer repair don't readily lend themselves to such measures.

LO2.7 Describe several factors that affect productivity.

Factors that Affect Productivity

Numerous factors affect productivity. Generally, they are methods, capital, quality, technology, and management.

A commonly held misconception is that workers are the main determinant of productivity. According to that theory, the route to productivity gains involves getting employees to work harder. However, the fact is that many productivity gains in the past have come from *technological* improvements. Familiar examples include:

Drones	Automation	GPS devices
Copiers and scanners	Calculators	Smartphones
The internet, search engines	Computers	Apps
Voice mail	Email	3D printers
Radio frequency ID tags	Software	Medical imaging

However, technology alone won't guarantee productivity gains; it must be used wisely and thoughtfully. Without careful planning, technology can actually *reduce* productivity, especially if it leads to inflexibility, high costs, or mismatched operations. Another current productivity pitfall results from employees' use of computers or smartphones for nonwork-related activities (playing games or checking stock prices or sports scores on the internet or smartphones, and texting friends and relatives). Beyond all of these is the dip in productivity that results while employees learn to use new equipment or procedures that will eventually lead to productivity gains after the learning phase ends.

Other factors that affect productivity include the following:

Standardizing processes and procedures wherever possible to reduce variability can have a significant benefit for both productivity and quality.

Quality differences may distort productivity measurements. One way this can happen is when comparisons are made over time, such as comparing the productivity of a factory now with one 30 years ago. Quality is now much higher than it was then, but there is no simple way to incorporate quality improvements into productivity measurements.

Use of the internet can lower costs of a wide range of transactions, thereby increasing productivity. It is likely that this effect will continue to increase productivity in the foreseeable future.

Computer viruses can have an immense negative impact on productivity.

Searching for lost or misplaced items wastes time, hence negatively affecting productivity.

Scrap rates have an adverse effect on productivity, signaling inefficient use of resources.

New workers tend to have lower productivity than seasoned workers. Thus, growing companies may experience a productivity lag.

Safety should be addressed. Accidents can take a toll on productivity.

A shortage of technology-savvy workers hampers the ability of companies to update computing resources, generate and sustain growth, and take advantage of new opportunities.

Layoffs often affect productivity. The effect can be positive and negative. Initially, productivity may increase after a layoff, because the workload remains the same but fewer workers do the work—although they have to work harder and longer to do it. However, as time goes by, the remaining workers may experience an increased risk of burnout, and they may fear additional job cuts. The most capable workers may decide to leave.

Labor turnover has a negative effect on productivity; replacements need time to get up to speed.

Design of the workspace can impact productivity. For example, having tools and other work items within easy reach can positively impact productivity.

Incentive plans that reward productivity increases can boost productivity.

And there are still other factors that affect productivity, such as *equipment breakdowns* and *shortages* of parts or materials. The education level and training of workers and their health can greatly affect productivity. The opportunity to obtain lower costs due to higher productivity elsewhere is a key reason many organizations turn to *outsourcing*. Hence, an alternative to outsourcing can be improved productivity. Moreover, as a part of their strategy for quality, the best organizations strive for *continuous improvement*. Productivity improvements can be an important aspect of that approach.

Improving Productivity

A company or a department can take a number of key steps toward improving productivity:

1. Develop productivity measures for all operations. Measurement is the first step in managing and controlling an operation.
2. Look at the system as a whole in deciding which operations are most critical. It is overall productivity that is important. Managers need to reflect on the value of potential productivity improvements *before* okaying improvement efforts. The issue is *effectiveness*. There are several aspects of this. One is to make sure the result will be something customers want. For example, if a company is able to increase its output through productivity improvements, but then is unable to sell the increased output, the increase in productivity isn't effective. Second, it is important to adopt a systems viewpoint: A productivity increase in one part of an operation that doesn't increase the productivity of the system would not be effective. For example, suppose a system consists of a sequence of two operations, where the output of the first operation is the input to the second



Stryker Howmedica set up a team to improve the running of its packaging line. A strategy focus on productivity improvement was used. The team adopted an approach based on the production system of Toyota. The goal was to satisfy the customer expectations for delivery and quality, while achieving gains in productivity. After the team identified needs and set objectives, a number of improvements were implemented. A one-piece flow was established that

reduced bottlenecks in the flow of devices through a clean room and the total time spent blister sealing devices was lowered. Within a short time, productivity nearly doubled from 36 devices per hour to 60 devices per hour, work-in-progress inventory fell, and a 10 percent reduction in the standard cost of product was achieved.

Source: Based on Lauraine Howley, "A Strategy for Company Improvement," *Medical Device Technology* 11, no. 2 (March 2000), p. 33.

operation, and each operation can complete its part of the process at a rate of 20 units per hour. If the productivity of the first operation is increased, but the productivity of the second operation is not, the output of the system will still be 20 units per hour.

3. Develop methods for achieving productivity improvements, such as soliciting ideas from workers (perhaps organizing teams of workers, engineers, and managers), studying how other firms have increased productivity, and reexamining the way work is done.
4. Establish reasonable goals for improvement.
5. Make it clear that management supports and encourages productivity improvement. Consider incentives to reward workers for contributions.
6. Measure improvements and publicize them.

Don't confuse productivity with *efficiency*. Efficiency is a narrower concept that pertains to getting the most out of a *fixed* set of resources; productivity is a broader concept that pertains to effective use of overall resources. For example, an efficiency perspective on mowing a lawn with a hand mower would focus on the best way to use the hand mower; a productivity perspective would include the possibility of using a power mower.

Fracking productivity improvement is another example. Drilling methods have become more effective. Drillers are now adopting a hydraulic fracturing method pioneered by companies such as Liberty Resources and EOG Resources that uses larger amounts of water and minerals. Although it is a more costly process, it has increased production rates in the first year of a well's life, after which output tends to drop off dramatically. Processes such as these have reduced the break-even cost of producing a barrel of oil and kept profitable some acreage that drillers might otherwise have left idle.

SUMMARY

Competition is the driving force in many organizations. It may involve price, quality, special features or services, time, or other factors. To develop effective strategies for business, it is essential for organizations to determine what combinations of factors are important to customers, which factors are order qualifiers, and which are order winners. Moreover, managers must be constantly on the lookout for changes in internal or external conditions that could necessitate a change in strategy.

It is essential that goals and strategies be aligned with the organization's mission. Strategies are plans for achieving organizational goals. They provide focus for decision making. Strategies must take into account present and future customer wants, as well as the organization's strengths and weaknesses, and threats and opportunities. These can run the gamut from what competitors are doing, or are likely to do, to technology, supply chain management, and e-business. Organizations generally have overall strategies that pertain to the entire organization, and strategies that pertain to each of the functional areas. Functional strategies are narrower in scope and should be linked to overall strategies. Time-based strategies and quality-based strategies are among the most widely used strategies business organizations employ to serve their customers and to become more productive. The chapter includes a description of the Balanced Scorecard approach, which can be helpful for transforming strategies into actions, and the implications of organization strategy for operations management.

Productivity is a measure of the use of resources. There is considerable interest in productivity both from an organizational standpoint and from a national standpoint. Business organizations want higher productivity because it yields lower costs and helps them to become more competitive. Nations want higher productivity because it makes their goods and services more attractive, offsets inflationary pressures associated with higher wages, and results in a higher standard of living for their people.

1. Competitive pressure often means that business organizations must frequently assess their competitors' strengths and weaknesses, as well as their own, to remain competitive.
2. Strategy formulation is critical because strategies provide direction for the organization, so they can play a role in the success or failure of a business organization.
3. Functional strategies and supply chain strategies need to be aligned with the goals and strategies of the overall organization.
4. The three primary business strategies are low cost, responsiveness, and differentiation.
5. Productivity is a key factor in the cost of goods and services. Increases in productivity can become a competitive advantage.
6. High productivity is particularly important for organizations that have a strategy of low costs.

competitiveness, 42
 core competencies, 46
 environmental scanning, 48
 goals, 44
 mission, 44

mission statement, 44
 operations strategy, 51
 order qualifiers, 48
 order winners, 48
 productivity, 56

quality-based strategies, 52
 strategies, 44
 SWOT, 48
 tactics, 45
 time-based strategies, 53

KEY POINTS

KEY TERMS

SOLVED PROBLEMS

Computing Productivity

A company that processes fruits and vegetables is able to produce 400 cases of canned peaches in one-half hour with four workers. What is labor productivity?

$$\begin{aligned} \text{Labor productivity} &= \frac{\text{Quantity produced}}{\text{Labor hours}} = \frac{400 \text{ cases}}{4 \text{ workers} \times 1/2 \text{ hour/worker}} \\ &= 200 \text{ cases per labor hour} \end{aligned}$$

Computing Multifactor Productivity

A wrapping-paper company produced 2,000 rolls of paper in one day. Labor cost was \$160, material cost was \$50, and overhead was \$320. Determine the multifactor productivity.

$$\begin{aligned} \text{Multifactor productivity} &= \frac{\text{Quantity produced}}{\text{Labor cost} + \text{Material cost} + \text{Overhead}} \\ &= \frac{2,000 \text{ rolls}}{\$160 + \$50 + \$320} = 3.77 \text{ rolls per dollar input} \end{aligned}$$

A variation of the multifactor productivity calculation incorporates the standard price in the numerator by multiplying the units by the standard price.

Computing Multifactor Productivity

Compute the multifactor productivity measure for an eight-hour day in which the usable output was 300 units, produced by three workers who used 600 pounds of materials. Workers have an hourly wage of \$20, and material cost is \$1 per pound. Overhead is 1.5 times labor cost.

$$\begin{aligned} \text{Multifactor productivity} &= \frac{\text{Usable output}}{\text{Labor cost} + \text{Material cost} + \text{Overhead cost}} \\ &= \frac{300 \text{ units}}{(3 \text{ workers} \times 8 \text{ hours} \times \$20/\text{hour}) + (600 \text{ pounds} \times \$1/\text{pound}) + (3 \text{ workers} \times 8 \text{ hours} \times \$20/\text{hour} \times 1.50)} \\ &= \frac{300 \text{ units}}{\$480 + \$600 + \$720} \\ &= .167 \text{ units of output per dollar of input} \end{aligned}$$

Problem 1

mhhe.com/stevenson14e

Solution**Problem 2**

mhhe.com/stevenson14e

Solution**Problem 3**

mhhe.com/stevenson14e

Solution



Computing Multifactor Productivity

A health club has two employees who work on lead generation. Each employee works 40 hours a week, and is paid \$20 an hour. Each employee identifies an average of 400 possible leads a week from a list of 8,000 names. Approximately 10 percent of the leads become members and pay a onetime fee of \$100. Material costs are \$130 per week, and overhead costs are \$1,000 per week. Calculate the multifactor productivity for this operation in fees generated per dollar of input.

Solution

$$\begin{aligned} \text{MFP} &= \frac{(\text{Possible leads})(\text{No. of workers})(\text{Fee})(\text{Conversion percentage})}{\text{Labor cost} + \text{Material cost} + \text{Overhead cost}} \\ &= \frac{(400)(2)(\$100)(.10)}{2(40)(\$20) + \$130 + \$1,000} = \frac{\$8,000}{\$2,730} = 2.93 \end{aligned}$$

DISCUSSION AND REVIEW QUESTIONS

- From time to time, various groups clamor for import restrictions or tariffs on foreign-produced goods, particularly automobiles. How might these be helpful? Harmful?
- List the key ways that organizations compete.
- Explain the importance of identifying and differentiating order qualifiers and order winners.
- Select two stores you shop at, and state how they compete.
- What is the Balanced Scorecard and how is it useful?
- Contrast the terms *strategies* and *tactics*.
- Contrast *organization strategy* and *operations strategy*.
- Explain the term *time-based strategies* and give three examples.
- Productivity should be a concern of every business organization.
 - How is productivity defined?
 - How are productivity measures used?
 - Why is productivity important?
 - What part of the organization has the primary responsibility of productivity?
 - How is efficiency different from productivity?
- List some factors that can affect productivity, as well as some ways that productivity can be improved.
- It has been said that a typical Japanese automobile manufacturer produces more cars with fewer workers than its U.S. counterpart. What are some possible explanations for this, assuming that U.S. workers are as hardworking as Japanese workers?
- Boeing's strategy appears to focus on its 777 midsize plane's ability to fly into smaller, nonhub airports. Rival European Airbus's strategy appears to focus on large planes. Compare the advantages and disadvantages of these two strategies.
- Name 10 ways that banks compete for customers.
- Explain the rationale of an operations strategy that seeks to increase the opportunity for use of technology by reducing variability in processing requirements.
- Identify two companies that have time-based strategies, and two that have quality-based strategies.

TAKING STOCK

- Who needs to be involved in formulating organizational strategy?
- Name some of the competitive trade-offs that might arise in a fast-food restaurant.
- How can technology improve:
 - competitiveness?
 - productivity?

CRITICAL THINKING EXERCISES

- In the past, there was concern about a “productivity paradox” related to IT services. More recently, there have been few references to this phenomenon. Using the internet, explain the term *productivity paradox*. Why do you think that the discussion of that topic has faded?
- A U.S. company has two manufacturing plants, one in the United States and one in another country. Both produce the same item, each for sale in their respective countries. However, their productivity figures are quite different. The analyst thinks this is because the U.S. plant uses more automated equipment for processing, while the other plant uses a higher percentage of labor. Explain how that factor can cause productivity figures to be misleading. Is there another way to compare the two plants that would be more meaningful?
- While it is true that increases in efficiency generate productivity increases, it is possible to get caught in an “efficiency improvement trap.” Explain what this means.
- It is common knowledge that Sam’s boss Dom has been fudging the weekly productivity figures. Several employees, including Sam, have spoken to him about this, but he continues to do it. Sam has observed a drop in morale among his coworkers due to this. Sam is thinking about sending an anonymous note to Dom’s boss. Would that be ethical? What would you do if you were Sam?
- Give two examples of what would be considered unethical involving competition and the ethical principles (see Chapter 1) that would be violated.

PROBLEMS

- A catering company prepared and served 300 meals at an anniversary celebration last week using eight workers. The week before, six workers prepared and served 240 meals at a wedding reception.
 - For which event was the labor productivity higher? Explain.
 - What are some possible reasons for the productivity differences?
- The manager of a crew that installs carpeting has tracked the crew’s output over the past several weeks, obtaining these figures:

Week	Crew Size	Yards Installed
1	4	96
2	3	72
3	4	92
4	2	50
5	3	69
6	2	52

Compute the labor productivity for each of the weeks. On the basis of your calculations, what can you conclude about crew size and productivity?

- Compute the multifactor productivity measure for each of the weeks shown for production of chocolate bars. What do the productivity figures suggest? Assume 40-hours work in a week and an hourly wage of \$12. Overhead is 1.5 times weekly labor cost. Material cost is \$6 per pound.

Week	Output (units)	Workers	Material (lbs)
1	30,000	6	450
2	33,600	7	470
3	32,200	7	460
4	35,400	8	480

- A company that makes shopping carts for supermarkets and other stores recently purchased some new equipment that reduces the labor content of the jobs needed to produce the shopping carts. Prior to buying the new equipment, the company used five workers, who produced an average of 80 carts per hour. Workers receive \$10 per hour, and machine cost was \$40 per hour. With the new equipment, it was possible to transfer one of the workers to another department, and equipment cost increased by \$10 per hour, while output increased by four carts per hour.
 - Compute labor productivity under each system. Use carts per worker per hour as the measure of labor productivity.
 - Compute the multifactor productivity under each system. Use carts per dollar cost (labor plus equipment) as the measure.
 - Comment on the changes in productivity according to the two measures, and on which one you believe is the more pertinent for this situation.

5. An operation has a 10 percent scrap rate. As a result, 72 pieces per hour are produced. What is the potential increase in labor productivity that could be achieved by eliminating the scrap?
6. A manager checked production records and found that a worker produced 160 units while working 40 hours. In the previous week, the same worker produced 138 units while working 36 hours. Did the worker's productivity increase, decrease, or remain the same? Explain.
7. The following table shows data on the average number of customers processed by several bank service units each day. The hourly wage rate is \$25, the overhead rate is 1.0 times labor cost, and material cost is \$5 per customer.

Unit	Employees	Customers Processed/Day
A	4	36
B	5	40
C	8	60
D	3	20

- a. Compute the labor productivity and the multifactor productivity for each unit. Use an eight-hour day for multifactor productivity.
 - b. Suppose a new, more standardized procedure is to be introduced that will enable each employee to process one additional customer per day. Compute the expected labor and multifactor productivity rates for each unit.
8. A property title search firm is contemplating using online software to increase its search productivity. Currently, an average of 40 minutes is needed to do a title search. The researcher cost is \$2 per minute. Clients are charged a fee of \$400. Company A's software would reduce the average search time by 10 minutes, at a cost of \$3.50 per search. Company B's software would reduce the average search time by 12 minutes at a cost of \$3.60 per search. Which option would have the higher productivity in terms of revenue per dollar of input?
 9. A company offers ID theft protection using leads obtained from client banks. Three employees work 40 hours a week on the leads, at a pay rate of \$25 per hour per employee. Each employee identifies an average of 3,000 potential leads a week from a list of 5,000. An average of 4 percent actually sign up for the service, paying a one-time fee of \$70. Material costs are \$1,000 per week, and overhead costs are \$9,000 per week. Calculate the multifactor productivity for this operation in fees generated per dollar of input.



The Company

The baking company is located in a small town in New York State. The bakery is run by two brothers. The company employs fewer than 200 people, mainly blue-collar workers, and the atmosphere is informal.

The Product

The company's only product is soft cookies, of which it makes over 50 varieties. Larger companies, such as Nabisco, Sunshine, and Keebler, have traditionally produced biscuit cookies, in which most of the water has been baked out, resulting in crisp cookies. The cookies have no additives or preservatives. The high quality of the cookies has enabled the company to develop a strong market niche for its product.

The Customers

The cookies are sold in convenience stores and supermarkets throughout New York, Connecticut, and New Jersey. The company markets its cookies as "good food"—no additives or preservatives—and this appeals to a health-conscious segment of the market. Many customers are over 45 years of age, and prefer a cookie that is soft and not too sweet. Parents with young children also buy the cookies.

The Production Process

The company has two continuous band ovens that it uses to bake the cookies. The production process is called a batch processing system. It begins as soon as management gets orders from distributors. These orders are used to schedule production. At the start of each shift, a list of the cookies to be made that day is delivered to the person in charge of mixing. That person checks a master list, which indicates the ingredients needed for each type of cookie, and enters that information into the computer. The computer then determines the amount of each ingredient needed, according to the quantity of cookies ordered, and relays that information to storage silos located outside the plant where the main ingredients (flour, sugar, and cake flour) are stored. The ingredients are automatically sent to giant mixing machines where the ingredients are combined with proper amounts of eggs, water, and flavorings. After the ingredients have been mixed, the batter is poured into a cutting machine where it is cut into individual cookies. The cookies are then dropped onto a conveyor belt and transported through one of two ovens. Filled cookies, such as apple, date, and raspberry, require an additional step for filling and folding.

The nonfilled cookies are cut on a diagonal rather than round. The diagonal-cut cookies require less space than straight-cut cookies, and the result is a higher level of productivity. In addition, the company recently increased the length of each oven by 25 feet, which also increased the rate of production.

As the cookies emerge from the ovens, they are fed onto spiral cooling racks 20 feet high and 3 feet wide. As the cookies come off the cooling racks, workers place the cookies into boxes manually, removing any broken or deformed cookies in the process. The boxes are then wrapped, sealed, and labeled automatically.

Inventory

Most cookies are loaded immediately onto trucks and shipped to distributors. A small percentage are stored temporarily in the company's warehouse, but they must be shipped shortly because of their limited shelf life. Other inventory includes individual cookie boxes, shipping boxes, labels, and cellophane for wrapping. Labels are reordered frequently, in small batches, because FDA label requirements are subject to change, and the company does not want to get stuck with labels it can't use. The bulk silos are refilled two or three times a week, depending on how quickly supplies are used.

Cookies are baked in a sequence that minimizes downtime for cleaning. For instance, light-colored cookies (e.g., chocolate chip) are baked before dark-colored cookies (e.g., fudge), and oatmeal cookies are baked before oatmeal raisin cookies. This lets the company avoid having to clean the processing equipment every time a different type of cookie is produced.

Quality

The bakery prides itself on the quality of its cookies. Cookies are sampled randomly by a quality control inspector as they come off the line to assure that their taste and consistency are satisfactory, and that they have been baked to the proper degree. Also, workers on the line are responsible for removing defective cookies when they spot them. The company has also installed an X-ray machine on the line that can detect small bits of metal filings that may have gotten into cookies during the production process. The use of automatic equipment for transporting raw materials and mixing batter has made it easier to maintain a sterile process.

Scrap

The bakery is run very efficiently and has minimal amounts of scrap. For example, if a batch is mixed improperly, it is sold for dog food. Broken cookies are used in the oatmeal cookies. These practices reduce the cost of ingredients and save on waste disposal costs. The company also uses heat reclamation: The heat that escapes from the two ovens is captured and used to boil the water that supplies the heat to the building. Also, the use of automation in the mixing process has resulted in a reduction in waste compared with the manual methods used previously.

New Products

Ideas for new products come from customers, employees, and observations of competitors' products. New ideas are first examined to determine whether the cookies can be made with existing equipment. If so, a sample run is made to determine the cost and time requirements. If the results are satisfactory, marketing tests are conducted to see if there is a demand for the product.

Potential Improvements

There are a number of areas of potential improvement at the bakery. One possibility would be to automate packing the cookies into boxes. Although labor costs are not high, automating the process

(continued)

(concluded)

might save some money and increase efficiency. So far, the owners have resisted making this change because they feel an obligation to the community to employ the 30 women who now do the boxing manually. Another possible improvement would be to use suppliers who are located closer to the plant. That would reduce delivery lead times and transportation costs, but the owners are not convinced that local suppliers could provide the same good quality. Other opportunities have been proposed in recent years, but the owners rejected them because they feared that the quality of the product might suffer.

Questions

1. Briefly describe the cookie production process.
2. What are two ways that the company has increased productivity? Why did increasing the length of the ovens result in a faster output rate?
3. Do you think that the company is making the right decision by not automating the packing of cookies? Explain your reasoning. What obligation does a company have to its employees in a situation such as this? What obligation does it have to the community? Is the size of the town a factor? Would it make a difference if the company was located in a large city? Is the size of the company a factor? What if it were a much larger company?
4. What factors cause the company to carry minimal amounts of certain inventories? What benefits result from this policy?
5. As a consumer, what things do you consider in judging the quality of cookies you buy in a supermarket?
6. What advantages and what limitations stem from the company's not using preservatives in cookies?
7. Briefly describe the company's strategy.

CASE



HAZEL REVISITED

(Refer to the Hazel Case at the end of chapter 1.)

1. What competitive advantage does Hazel have over a professional lawn care service?
2. Hazel would like to increase her profits, but she doesn't believe it would be wise to raise her prices considering the current state of the local economy. Instead, she has given some thought to increasing productivity.
 - a. Explain how increased productivity could be an alternative to increased prices.
 - b. What are some ways that Hazel could increase productivity?
3. Hazel is thinking about the purchase of new equipment. One would be power sidewalk edgers. She believes edgers will lead to an increase in productivity. Another would be a chain saw, which would be used for tree pruning. What trade-offs should she consider in her analysis?
4. Hazel has been fairly successful in her neighborhood, and now wants to expand to other neighborhoods, including some that are five miles away. What would be the advantages and disadvantages of doing this?
5. Hazel does not have a mission statement or a set of objectives. Take one of the following positions and defend it:
 - a. Hazel doesn't need a formal mission statement and objectives. Many small businesses don't have them.
 - b. She definitely needs a mission statement and a set of objectives. They would be extremely beneficial.
 - c. There may be some benefit to Hazel's business, and she should consider developing one.



JOSEPH MURRAY, GRAND VALLEY STATE UNIVERSITY

"Your Garden Gloves" is a small gardening business located in Michigan. The company plants and maintains flower gardens for both commercial and residential clients. The company was founded about five years ago, and has since grown substantially, averaging about 10 new clients and one new employee a year. The company currently employs eight seasonal employees who are responsible for a certain number of clients.

Each morning, crews are assigned to jobs by the owner. Crew sizes range from two to four workers. Crew size and composition are a function of the square footage of the garden and requirements of the job. The owner feels that large jobs should be assigned to crews of four workers in order to complete the job in a reasonable amount of time.

From time to time, the owner noticed that some jobs, especially the largest ones, took longer than she had estimated, based on the square footage of the garden space involved. The owner's son, Joe, decided to investigate. He kept records of job times and crew sizes, and then used those records to compute labor productivity. The results were:

Crew Size	Average Productivity per Crew
2	4,234 square feet per day
3	5,352 square feet per day
4	7,860 square feet per day

The company operates on a small profit margin, so it is especially important to take worker productivity into account.

Questions

1. Which crew size had the highest productivity per worker? Which crew size had the lowest productivity per worker? What are some possible explanations for these results?
2. After a recent storm, a customer called in a panic, saying she had planned a garden party for the upcoming weekend and her garden was in a shambles. The owner decided to send a crew of four workers, even though a two-worker crew would have a higher productivity. Explain the rationale for this decision.
3. What is a possible qualitative issue that may very well influence productivity levels that the productivity ratios fail to take into account?



BY LISA SPENCER

Girlfriend Collective wants customers to love its products and wear them with pride. Designing for an audience that cares about where clothes come from, as well as how they look and fit, the founders of Girlfriend Collective made transparency a top priority. Its website freely shares the details of the production process so consumers can learn about its high standards and how it operates. Every part of the process, including sourcing materials, designing products, choosing facilities, and selecting partners, was carefully and painstakingly done with ethics and sustainability in mind.

Recycled Polyester

Girlfriend Collective's innovative leggings are made from 25 RPET recycled plastic water bottles combined with 21 percent spandex. The company sources its post-consumer water bottles from Taiwan, a country known as "Garbage Island" until its government initiated a sweeping program that put the small country on the forefront of global recycling. In communities throughout the country, people come together every night to sort their waste into containers for recyclables, food waste, and garbage. When they finish, neighbors linger to socialize until the collection trucks come, building relationships and community ties. In rural areas, various programs and

volunteer groups set up micro-recycling centers where people can drop off recyclables and learn more about environmental stewardship. Whereas the United States only recycles about 35 percent of its waste, Taiwan now recycles 55 percent.

Recycled Fabric

Once bottles are collected, they are sorted into various grades and sent to processing centers. Girlfriend Collective uses only #1 plastic, known as Polyethylene Terephthalate (PET), to make its polyester yarn and fabric. Plastics containing BPA, which some believe pose a health threat, are never used.

The #1 bottles are cleaned and shredded at a Taiwanese processing center that is family owned and operated and has a long-standing history of doing things right. The facility is also certified by the Taiwanese government. Thus, in addition to having permission to process and resell plastic, security measures are in place, and plastic intake and output are carefully tracked. Certification means a lot in a world where lax standards often let unscrupulous recyclers purchase brand new plastic bottles, lie about their sourcing, and sell them to unwitting companies that want to use recyclables in their products. This is much cheaper than the process

(continued)

(concluded)

required to clean and process post-consumer bottles. It is also completely at odds with sustainability goals.

At the bottle processing facility used by Girlfriend Collective, bales of bottles collected from across Taiwan are weighed, logged, steam washed to remove caps and labels, and then separated by color. Clear bottles are used to make fibers for leggings, and colored bottles are sent away for other uses. Next, bottles are shredded into tiny chips, washed again, bagged, and sent to the fiber-making facility. By weighing and logging each bag, the factory verifies that the output equals the input of plastic bottles used to create it. Thus, buyers like Girlfriend Collective know with certainty that the chips came from the same post-consumer bottles originally taken in.

Making Fabric

Bags of raw PET chips travel from the recycling facility to the spinning mill where they are washed again, dried, and sent to storage silos. Next, the chips are heated and extruded. The process yields long, spaghetti-like strands that will be cut into tiny pellets. Pellets go through one more round of heating and extrusion, eventually yielding superfine thread. The thread is spun into yarn and onto large bobbins for packaging and shipment. Once the yarn arrives at Girlfriend Collective's highly unique knitting factory, it will be turned into a material that is softer and more stable than traditional fabrics. The innovative knitting technique, however, is a very slow and precise process that in 24 hours only yields enough fabric to make about 100 pairs of leggings.

From knitting, the fabric goes to the dye house. For many companies, this is an environmentally harmful process that dumps red or blue wastewater from chemicals and dyes into streams and rivers on their way to community water tables, harming both people and crops. In contrast, Girlfriend Collective's facility treats all wastewater at a plant located 100 feet from the dyeing process. Certified safe dyes and any remaining fibers are removed from the water, and the water is tested for safety, approved by Taiwan's environmental agency, and only then released into a stream. Finally, while many companies send dye mud to landfills, Girlfriend Collective's facility sends it to a factory that turns it into pavers for community sidewalks.

Recycled Nylon

Always looking for new ideas, Girlfriend Collective has fashioned its newest line of LITE leggings from recycled fishing nets and other

nylon waste that would typically be dumped in oceans or landfills. Instead, the nylon discards make their way to a recycling facility to be given a new life. This helps to cut down on the 14 billion pounds of waste dumped into oceans every year, 10 percent of which is old fishing gear. It also means fewer brand-new raw materials, like crude oil, are needed in the nylon production process.

Cutting and Sewing

Fourteen people are needed to cut and sew every pair of leggings, making these steps the most labor-intensive part of the clothing manufacturing process. Girlfriend Collective takes pride in caring for workers, as well as caring for the environment. It partners with an SA8000 Danish, family-owned sewing facility in Vietnam with a history of treating employees well and paying them fairly. Some employee perks include a pay rate 25 percent above minimum wage, company-led exercise breaks, free catered meals, free bi-annual health checks, and health insurance. The SA8000 certification specifically ensures no forced labor or child labor are used and requires safe working conditions and the right to unionize. All of the by-laws and employee regulations guaranteed by SA8000 are even included on Girlfriend Collective's website.

Conclusion

From start to finish, Girlfriend Collective raises the bar on what sustainability really means and sets best practices for the garment industry.

Questions

1. What operations strategies are important at Girlfriend Collective?
2. In what ways do these strategies put Girlfriend Collective at a competitive advantage or disadvantage?
3. What short- and long-term impacts do Girlfriend Collective's business practices have on the garment industry? On recyclers? On communities? On profits?
4. How might sustainability measures for people and production processes impact productivity? How can companies balance a desire for ethics with productivity concerns?

Based on: "About Girlfriend Collective," <https://www.girlfriend.com/pages/about>

OPERATIONS TOUR



THE U.S. POSTAL SERVICE

"Neither rain, nor snow . . ."

The U.S. Postal Service (USPS) is the largest postal service in the world, handling about 47 percent (630 million pieces a day) of the world's mail volume. The second largest is Japan's, which handles only about 6 percent of the world's mail. The USPS is huge by any

standard. It employs over 635,000 workers, making it the largest civilian employer in the United States. It has over 300,000 mail collection boxes, 38,000 post offices, 130 million mail delivery points, more than 300 processing plants to sort and ship mail, and more than 75,000 pieces of mail processing equipment. It handles

over 100 billion pieces of first-class mail a year, and ships about 3 billion pounds of mail on commercial airline flights, making it the airlines' largest shipper.

Processing First-Class Mail

The essence of processing the mail is sorting, which means organizing the mail into smaller and smaller subgroups to facilitate its timely delivery. Sorting involves a combination of manual and automatic operations. Much of the mail that is processed is first-class mail.

Most first-class mail is handled using automated equipment. A small portion that cannot be handled by automated equipment must be sorted by hand, just the way it was done in colonial times.

The majority of first-class mail begins at the advanced facer canceling system. This system positions each letter so that it is face up, with the stamp in the upper corner, checks to see if the address is handwritten, and pulls the hand-addressed letters off the line. It also rejects letters that have the stamp covered by tape, have no postage, are third-class mail, or have meter impressions that are too light to read. The rejects are handled manually. The remaining letters are canceled and date stamped, and then sorted to one of seven stackers.

Next, the letters go to the multiline optical character readers, which can handle both printed and pre-bar-coded mail, but not hand-addressed mail. The optical reader sprays a bar code on the mail that hasn't been pre-bar-coded, which represents up to an 11-digit zip code. For hand-addressed mail, a camera focuses on the front of the letter, and the image is displayed on a remote terminal, often in another city, where an operator views the image and provides the information that the optical readers could not determine so that a bar code can be added.

Bar-code readers then sort the mail into one of 96 stackers, doing this at a rate of more than 500 a minute. The mail goes through another sort using manually controlled mechanical equipment. At that point, the mail is separated according to whether it is local or out-of-town mail. The out-of-town mail is placed into appropriate sacks according to its destination, and moved to the outgoing send area where it will be loaded on trucks.

The local mail is moved to another machine that not only sorts the mail into local carrier delivery routes, it sorts it according to delivery walk sequence!

Small parcels, bundles of letters, and bundles of flats are sorted by a bundle-sorting machine.

Productivity

Over the years, the USPS has experienced an ever-increasing volume of mail. Productivity has been an important factor for the USPS in keeping postal rates low and maintaining rapid delivery service. Two key factors in improved productivity have been the increased use of automation and the introduction of zip codes.

Mail processing underwent a major shift to mechanization during the 1950s and 1960s, which led to more rapid processing and higher productivity. In 1978, an expanded zip code was introduced. That was followed in 1983 by a four-digit expansion in zip codes. These changes required new, automated processing

equipment, and the use of bar codes and optical readers. All of these changes added greatly to productivity. But even with these improvements, the USPS faced increasing competitive pressures.

Competition

In the late 1980s, the USPS experienced a slowdown in the volume of mail. Some of this was due to a slowing of the economy, but most of it was the result of increasing competition. Delivery giants FedEx and UPS, as well as other companies that offer speedy delivery and package tracking, gave businesses and the general public convenient alternatives for some mail services. At the same time, there was a growing use of fax machines and electronic communications and increased use of alternate forms of advertising such as cable TV, all of which cut into the volume of mail. Early in this century, e-mail and automated bill paying also cut into mail volume.

Strategies and Tactics Used to Make the Postal Service More Competitive

To meet these challenges, the USPS developed several strategies to become more competitive. These included reorganizing, continuing to seek ways to keep costs down, increasing productivity, and emphasizing quality and customer service. Here is an overview of the situation and the strategies and tactics used by the USPS.

The USPS began working more closely with customers to identify better ways to meet their needs and expanded customer conveniences such as stamps on consignment. With the help of business mailers, the USPS continued support for rates reflecting customer work-sharing features, many tied to automation, to give customers more flexibility. At the same time, the USPS began forming Customer Advisory Councils—groups of citizens who volunteered to work with local postal management on postal issues of interest to the community. In 1990, the USPS awarded two contracts to private firms to measure first-class mail service and customer satisfaction. In 1992, the USPS stepped up its quest to become more competitive by reducing bureaucracy and overhead in order to improve service and customer satisfaction, and to reduce the need to increase postage rates.

To help accomplish these goals, the USPS underwent a reorganization. Layers of management were eliminated and overhead positions were cut by about 30,000. Five regions and 73 field divisions were replaced by 10 areas, each with a manager for customer services and a manager for processing and distribution. Ten customer service areas were established, with managers for customer service and processing and distribution in each area, as well as a marketing and sales office. The new structure allowed postal managers to be focused, improved communications, and empowered employees to meet customer needs. The USPS also took other steps to improve service. In 1993, it implemented improvements in processing and mail delivery at major postal facilities, expanded retail hours, and developed a more user-friendly Domestic Mail Manual. In cooperation with business customers, the USPS began to develop new services to meet specific mailer needs and to overhaul and simplify its complex rate structure. It also awarded contracts for two more external tracking systems, one to measure satisfaction levels of business mailers, and the other to measure service performance of third-class mail.

(continued)







(concluded)

The reorganization eliminated some programs, cut costs, attracted new business, and reduced the USPS's projected deficit.

The postal services' sustainability scorecard for 2015 is shown as follows.

**United States
Postal Service**





















**January 2015 OMB Scorecard on
Sustainability/Energy**

<p>Scope 1&2 GHG Emission Reduction Target</p> <p>For Scope 1&2 GHG Reduction Target of 20% by 2020: 17% reduction in 2014 and on track</p>	 <p>Score: GREEN</p>
<p>Scope 3GHG Emission Reduction Target</p> <p>For Scope 3GHG Reduction Target of 20% by 2020: 24% reduction in 2014 and on track</p>	 <p>Score: GREEN</p>
<p>Reduction in Energy Intensity</p> <p>Reduction in energy intensity in goal-subject facilities compared with 2003: 32% and on track for 30% by 2015</p>	 <p>Score: GREEN</p>
<p>Use of Renewable Energy</p> <p>Not applicable</p>	 <p>Score: N/A</p>
<p>Reduction in Potable Water Intensity</p> <p>Reduction in potable water intensity compared with 2007: 30% and on track for 26% in 2020</p>	 <p>Score: GREEN</p>
<p>Reduction in Fleet Petroleum Use</p> <p>Reduction in fleet petroleum use compared to 2005: 10.1% increase and not on track</p>	 <p>Score: RED</p>
<p>Green Buildings</p> <p>Not applicable</p>	 <p>Score: N/A</p>

Questions

1. Why is it important for the USPS to have a high volume of mail to process?
2. What caused productivity to increase?
3. What impact did competitive pressures have on the USPS?
4. What measures did the USPS adopt to increase competitiveness?
5. What results were achieved by the USPS's changes?
6. What effect does the increased use of e-mail have on postal productivity?
7. How does the use of standard shipping containers and flat-rate mailers help competitiveness?

Standards for Success — Red Standard, Yellow Standard, Green Standard

Scope 1&2 GHG Emission Reduction Target		GREEN: On track to achieve agency's proposed 2020 GHG Scopes 1&2 emissions reduction target.
		YELLOW: Less than a year behind glide path to achieve agency's 2020 target for GHG Scopes 1&2.
		RED: More than a year behind glide path to achieve agency's 2020 target for GHG Scopes 1&2.
Scope 3 GHG Emission Reduction Target		GREEN: On track to achieve agency's proposed 2020 GHG Scope 3 emissions reduction target.
		YELLOW: Less than a year behind glide path to achieve agency's 2020 target for GHG Scope 3.
		RED: More than a year behind glide path to achieve agency's 2020 target for GHG Scope 3.
Reduction in Energy Intensity		GREEN: Reduced energy intensity (Btu/GSF*) in EISA goal-subject facilities by at least 27 percent compared with 2003 and is on track for 30 percent reduction by 2015.
		YELLOW: Reduced energy intensity (Btu/GSF) in EISA goal-subject facilities by at least 24 percent compared with 2003.
		RED: Did not reduce energy intensity (Btu/GSF) in EISA goal-subject facilities by at least 24 percent compared with 2003.
Use of Renewable Energy		GREEN: Uses at least 7.5 percent electricity from renewable sources as a percentage of facility electricity use and at least 3.75 percent of facility electricity use comes from new sources (post-1999). (Thermal and mechanical renewable can be included in the 3.75 percent new requirement, but not the 7.5 percent goal; i.e., an agency meets all new sources requirement with thermal or mechanical energy (3.75 percent) but would still need an additional 7.5 percent from renewable electricity sources.)
		YELLOW: Uses at least 7.5 percent renewable energy from electric, thermal, or mechanical sources to power facilities and equipment; but less than half was obtained from new sources (post-1999) or part of the requirement was met with thermal and mechanical renewable energy.
		RED: Did not use at least 7.5 percent renewable energy from electric, thermal, or mechanical sources to power facilities and equipment.
Reduction in Potable Water Intensity		GREEN: Reduced water intensity by at least 14 percent from final approved 2007 baseline and is on track for 26 percent reduction by 2020.
		YELLOW: Reduced water intensity by at least 12 percent from final approved 2007 baseline.
		RED: Did not reduce water intensity by at least 12 percent from final approved 2007 baseline.
Reduction in Fleet Petroleum Use		GREEN: Achieved an 18 percent reduction in petroleum use in its entire vehicle fleet compared to 2005 and is on track for 20 percent reduction by 2015.
		YELLOW: Achieved at least 16 percent reduction in petroleum use in the entire vehicle fleet compared to 2005.
		RED: Did not achieve at least 16 percent reduction in petroleum use in its entire vehicle fleet since 2005.
Green Buildings		GREEN: Demonstrates implementation of Guiding Principles for Federal Leadership in High Performance and Sustainable Buildings (GP) for new, existing and leased buildings; and is on track to meet 15% goal by 2015 by reporting that at least 13 percent of buildings over 5,000 GSF meet GP as reported in the Federal Real Property Profi (FRPP).
		YELLOW: Incorporates Guiding Principles into all new design contracts for construction, major renovations, and leases and at least 13 percent of GSF of its building inventory over 5,000 GSF meets GP as reported in FRPP.
		RED: Cannot demonstrate compliance with GP on new construction, major renovations, or leases; and/or less than 13 percent of building inventory, either by number of buildings or GSF, over 5,000 GSF meets GP as reported in FRPP.

*GSF = Gross Square Footage

Source: United States Postal Service

Fortune magazine

Hammer, Michael, and Steven Stanton. "Ignore Operations at Your Peril." *Harvard Business Review* 6565 (April 2004).

Hill, Terry. *Manufacturing Strategy: Text and Cases*, 3rd ed. New York: McGraw-Hill, 2000.

Porter, Michael E., "The Five Competitive Forces that Shape Strategy." *Harvard Business Review* 86, no. 1 (January 2008), pp. 78–93, 137.

Slack, Nigel, and Michael Lewis. *Operations Strategy*, 4e. Upper Saddle River, NJ: Prentice-Hall, 2011. Global Competitiveness Report.

Werbach, Adam. *Strategy for Sustainability: A Business Manifesto*. Boston: Harvard Business Press, 2009.

**SELECTED
BIBLIOGRAPHY AND
FURTHER READINGS**

Design element: Operations Tour (city map icon): tovovan/Shutterstock

3

Forecasting

CHAPTER

LEARNING OBJECTIVES

After completing this chapter, you should be able to:

- LO3.1** List features common to all forecasts.
- LO3.2** Explain why forecasts are generally wrong.
- LO3.3** List the elements of a good forecast.
- LO3.4** Outline the steps in the forecasting process.
- LO3.5** Describe four qualitative forecasting techniques.
- LO3.6** Use a naive method to make a forecast.
- LO3.7** Prepare a moving average forecast.
- LO3.8** Prepare a weighted-average forecast.
- LO3.9** Prepare an exponential smoothing forecast.
- LO3.10** Prepare a linear trend forecast.
- LO3.11** Prepare a trend-adjusted exponential smoothing forecast.
- LO3.12** Compute and use seasonal relatives.
- LO3.13** Compute and use regression and correlation coefficients.
- LO3.14** Summarize forecast errors and use summaries to make decisions.
- LO3.15** Construct control charts and use them to monitor forecast errors.
- LO3.16** Describe the key factors and trade-offs to consider when choosing a forecasting technique.

CHAPTER OUTLINE

- | | | |
|--|---|---|
| 3.1 Introduction 76 | 3.6 Approaches to Forecasting 80 | 3.8 Forecasts Based on Time-Series Data 82 |
| 3.2 Features Common to All Forecasts 78 | 3.7 Qualitative Forecasts 80 | Naive Methods 82 |
| 3.3 Elements of a Good Forecast 78 | Executive Opinions 80 | Techniques For Averaging 84 |
| 3.4 Forecasting and the Supply Chain 79 | Salesforce Opinions 81 | Other Forecasting Methods 88 |
| 3.5 Steps in the Forecasting Process 79 | Consumer Surveys 81 | Techniques For Trend 89 |
| | Other Approaches 81 | Trend-Adjusted Exponential Smoothing 92 |



Photodisc/Getty Images

Techniques For Seasonality 93	Nonlinear And Multiple Regression Analysis 104	3.13 Using Forecast Information 112
Techniques For Cycles 98	3.10 Forecast Accuracy 104	3.14 Computer Software in Forecasting 113
3.9 Associative Forecasting Techniques 98	Summarizing Forecast Accuracy 106	3.15 Operations Strategy 113
Simple Linear Regression 98	3.11 Monitoring Forecast Error 107	Cases: M&L Manufacturing 136
Comments On The Use Of Linear Regression Analysis 102	3.12 Choosing a Forecasting Technique 111	Highline Financial Services, Ltd., 137

Weather forecasts are one of the many types of forecasts used by some business organizations. Although some businesses simply rely on publicly available weather forecasts, others turn to firms that specialize in weather-related forecasts. For example, Home Depot, Gap, and JCPenney use such firms to help them take weather factors into account for estimating demand.

Many new car buyers have a thing or two in common. Once they make the decision to buy a new car, they want it as soon as possible. They usually don't want to order it and then have to wait six weeks or more for delivery. If the car dealer they visit doesn't have the car they want, they'll look elsewhere. Hence, it is important for a dealer to *anticipate* buyer wants and to have those models, with the necessary options, in stock. The dealer who can correctly forecast buyer wants, and have those cars available, is going to be much more successful than a competitor who guesses instead of forecasting—and guesses wrong—and gets stuck with cars customers don't want. So how does the dealer know how many cars of each type to stock? The answer is, the dealer *doesn't* know for sure, but by analyzing previous buying patterns, and perhaps making allowances for current conditions, the dealer can come up with a reasonable *approximation* of what buyers will want.

Planning is an integral part of a manager's job. If uncertainties cloud the planning horizon, managers will find it difficult to plan effectively. Forecasts help managers by reducing some of the uncertainty, thereby enabling them to develop

continued

Forecast A statement about the future value of a variable of interest.

more meaningful plans. A **forecast** is an estimate about the future value of a variable such as demand. The better the estimate, the more informed decisions can be. Some forecasts are long range, covering several years or more. Long-range forecasts are especially important for decisions that will have long-term consequences for an organization or for a town, city, country, state, or nation. One example is deciding on the right capacity for a planned power plant that will operate for the next 40 years. Other forecasts are used to determine if there is a profit potential for a new service or a new product: Will there be sufficient demand to make the innovation worthwhile? Many forecasts are short term, covering a day or week. They are especially helpful in planning and scheduling day-to-day operations. This chapter provides a survey of business forecasting. It describes the elements of good forecasts, the necessary steps in preparing a forecast, basic forecasting techniques, and how to monitor a forecast.

3.1 INTRODUCTION

Forecasts are a basic input in the decision processes of operations management because they provide information on future demand. The importance of forecasting to operations management cannot be overstated. The primary goal of operations management is to match supply to demand. Having a forecast of demand is essential for determining how much capacity or supply will be needed to meet demand. For instance, operations needs to know what capacity will be needed to make staffing and equipment decisions, budgets must be prepared, purchasing needs information for ordering from suppliers, and supply chain partners need to make their plans.

Businesses make plans for future operations based on anticipated future demand. Anticipated demand is derived from two possible sources, actual customer orders and forecasts. For businesses where customer orders make up most or all of anticipated demand, planning is straightforward, and little or no forecasting is needed. However, for many businesses, most or all of anticipated demand is derived from forecasts.

Two aspects of forecasts are important. One is the expected level of demand; the other is the degree of accuracy that can be assigned to a forecast (i.e., the potential size of forecast error). The expected level of demand can be a function of some structural variation, such as a trend or seasonal variation. Forecast accuracy is a function of the ability of forecasters to correctly model demand, random variation, and sometimes unforeseen events.

Forecasts are made with reference to a specific time horizon. The time horizon may be fairly short (e.g., an hour, day, week, or month), or somewhat longer (e.g., the next six months, the next year, the next five years, or the life of a product or service). Short-term forecasts pertain to ongoing operations. Long-range forecasts can be an important strategic planning tool. Long-term forecasts pertain to new products or services, new equipment, new facilities, or something else that will require a somewhat long lead time to develop, construct, or otherwise implement.

Forecasts are the basis for budgeting, planning capacity, sales, production and inventory, personnel, purchasing, and more. Forecasts play an important role in the planning process because they enable managers to anticipate the future so they can plan accordingly.

Forecasts affect decisions and activities throughout an organization, in accounting, finance, human resources, marketing, and management information systems (MIS), as well as in operations and other parts of an organization. Here are some examples of uses of forecasts in business organizations:

Accounting. New product/process cost estimates, profit projections, cash management.

Finance. Equipment/equipment replacement needs, timing and amount of funding/borrowing needs.

Human resources. Hiring activities, including recruitment, interviewing, and training; layoff planning, including outplacement counseling.

Marketing. Pricing and promotion, e-business strategies, global competition strategies.

MIS. New/revised information systems, internet services.

Operations. Schedules, capacity planning, work assignments and workloads, inventory planning, make-or-buy decisions, outsourcing, project management.

Product/service design. Revision of current features, design of new products or services.

In most of these uses of forecasts, decisions in one area have consequences in other areas. Therefore, it is very important for all affected areas to agree on a common forecast. However, this may not be easy to accomplish. Different departments often have very different perspectives on a forecast, making a consensus forecast difficult to achieve. For example, salespeople, by their very nature, may be overly optimistic with their forecasts, and may want to “reserve” capacity for their customers. This can result in excess costs for operations and inventory storage. Conversely, if demand exceeds forecasts, operations and the supply chain may not be able to meet demand, which would mean lost business and dissatisfied customers.

Forecasting is also an important component of *yield management*, which relates to the percentage of capacity being used. Accurate forecasts can help managers plan tactics (e.g., offer discounts, don't offer discounts) to match capacity with demand, thereby achieving high-yield levels.

There are two uses for forecasts. One is to help managers *plan the system*, and the other is to help them *plan the use of the system*. Planning the system generally involves long-range plans about the types of products and services to offer, what facilities and equipment to have, where to locate, and so on. Planning the use of the system refers to short-range and intermediate-range planning, which involve tasks such as planning inventory and workforce levels, planning purchasing and production, budgeting, and scheduling.

Business forecasting pertains to more than predicting demand. Forecasts are also used to predict profits, revenues, costs, productivity changes, prices and availability of energy and raw materials, interest rates, movements of key economic indicators (e.g., gross domestic product, inflation, government borrowing), and prices of stocks and bonds. For the sake of simplicity, this chapter will focus on the forecasting of demand. Keep in mind, however, that the concepts and techniques apply equally well to the other variables.



Peter Cosgrove/AP Images

The Walt Disney World forecasting department has 20 employees who formulate forecasts on volume and revenue for the theme parks, water parks, resort hotels, as well as merchandise, food, and beverage revenue by location.

Despite of its use of computers and sophisticated mathematical models, forecasting is not an exact science. Instead, successful forecasting often requires a skillful blending of science and intuition. Experience, judgment, and technical expertise all play a role in developing useful forecasts. Along with these, a certain amount of luck and a dash of humility can be helpful, because the worst forecasters occasionally produce a very good forecast, and even the best forecasters sometimes miss completely. Current forecasting techniques range from the mundane to the exotic. Some work better than others, but no single technique works all the time.

3.2 FEATURES COMMON TO ALL FORECASTS

LO3.1 List features common to all forecasts.

A wide variety of forecasting techniques are in use. In many respects, they are quite different from each other, as you shall soon discover. Nonetheless, certain features are common to all, and it is important to recognize them.

LO3.2 Explain why forecasts are generally wrong.

- Forecasting techniques generally assume that the same underlying causal system that existed in the past will continue to exist in the future.

Comment A manager cannot simply delegate forecasting to models or computers and then forget about it, because unplanned occurrences can wreak havoc with forecasts. For instance, weather-related events, tax increases or decreases, and changes in features or prices of competing products or services can have a major impact on demand. Consequently, a manager must be alert to such occurrences and be ready to override forecasts, which assume a stable causal system.

- Forecasts are not perfect; actual results usually differ from predicted values; the presence of randomness precludes a perfect forecast. Allowances should be made for forecast errors.
- Forecasts for groups of items tend to be more accurate than forecasts for individual items because forecasting errors among items in a group usually have a canceling effect. Opportunities for grouping may arise if parts or raw materials are used for multiple products or if a product or service is demanded by a number of independent sources.
- Forecast accuracy decreases as the time period covered by the forecast—the *time horizon*—increases. Generally speaking, short-range forecasts must contend with fewer uncertainties than longer-range forecasts, so they tend to be more accurate.

An important consequence of the last point is that flexible business organizations—those that can respond quickly to changes in demand—require a shorter forecasting horizon and, hence, benefit from more accurate short-range forecasts than competitors who are less flexible and who must therefore use longer forecast horizons.

3.3 ELEMENTS OF A GOOD FORECAST

LO3.3 List the elements of a good forecast.

A properly prepared forecast should fulfill certain requirements:

- The forecast should be **timely**. Usually, a certain amount of time is needed to respond to the information contained in a forecast. For example, capacity cannot be expanded overnight, nor can inventory levels be changed immediately. Hence, the forecasting horizon must cover the time necessary to implement possible changes.
- The forecast should be **accurate**, and the degree of accuracy should be stated. This will enable users to plan for possible errors and will provide a basis for comparing alternative forecasts.
- The forecast should be **reliable**; it should work consistently. A technique that sometimes provides a good forecast and sometimes a poor one will leave users with the uneasy feeling that they may get burned every time a new forecast is issued.

- The forecast should be expressed in **meaningful units**. Financial planners need to know how many *dollars* will be needed, production planners need to know how many *units* will be needed, and schedulers need to know what *machines* and *skills* will be required. The choice of units depends on user needs.
- The forecast should be **in writing**. Although this will not guarantee that all concerned are using the same information, it will at least increase the likelihood of it. In addition, a written forecast will permit an objective basis for evaluating the forecast once actual results are in.
- The forecasting technique should be **simple to understand and use**. Users often lack confidence in forecasts based on sophisticated techniques; they do not understand either the circumstances in which the techniques are appropriate or the limitations of the techniques. Misuse of techniques is an obvious consequence. Not surprisingly, fairly simple forecasting techniques enjoy widespread popularity because users are more comfortable working with them.
- The forecast should be **cost-effective**: The benefits should outweigh the costs.

3.4 FORECASTING AND THE SUPPLY CHAIN

Accurate forecasts are very important for the supply chain. Inaccurate forecasts can lead to shortages and excesses throughout the supply chain. Shortages of materials, parts, and services can lead to missed deliveries, work disruption, and poor customer service. Conversely, overly optimistic forecasts can lead to excesses of materials and/or capacity, which increase costs. Both shortages and excesses in the supply chain have a negative impact not only on customer service but also on profits. Furthermore, inaccurate forecasts can result in temporary increases and decreases in orders to the supply chain, which can be misinterpreted by the supply chain.

Organizations can reduce the likelihood of such occurrences in a number of ways. One, obviously, is by striving to develop the best possible forecasts. Another is through collaborative planning and forecasting with major supply chain partners. Yet another way is through information sharing among partners and perhaps increasing supply chain visibility by allowing supply chain partners to have real-time access to sales and inventory information. Also important is rapid communication about poor forecasts, as well as about unplanned events that disrupt operations (e.g., flooding, work stoppages), and changes in plans.

3.5 STEPS IN THE FORECASTING PROCESS

There are six basic steps in the forecasting process:

1. **Determine the purpose of the forecast.** How will it be used and when will it be needed? This step will provide an indication of the level of detail required in the forecast, the amount of resources (personnel, computer time, dollars) that can be justified, and the level of accuracy necessary.
2. **Establish a time horizon.** The forecast must indicate a time interval, keeping in mind that accuracy decreases as the time horizon increases.
3. **Obtain, clean, and analyze appropriate data.** Obtaining the data can involve significant effort. Once obtained, the data may need to be “cleaned” to get rid of outliers and obviously incorrect data before analysis.
4. **Select a forecasting technique.**
5. **Make the forecast.**
6. **Monitor the forecast errors.** The forecast errors should be monitored to determine if the forecast is performing in a satisfactory manner. If it is not, reexamine the method, assumptions, the validity of data, and so on; modify as needed; and prepare a revised forecast.

LO3.4 Outline the steps in the forecasting process.

Once the process has been set up, it may only be necessary to repeat steps 3 and 6 as new data become available.

Note, too, that additional action may be necessary. For example, if demand was much less than the forecast, an action such as a price reduction or a promotion may be needed. Conversely, if demand was much more than predicted, increased output may be advantageous. That may involve working overtime, outsourcing, or taking other measures.

3.6 APPROACHES TO FORECASTING

There are two general approaches to forecasting: qualitative and quantitative. Qualitative methods consist mainly of subjective inputs, which often defy precise numerical description. Quantitative methods involve either the projection of historical data or the development of associative models that attempt to utilize *causal (explanatory) variables* to make a forecast.

Qualitative techniques permit inclusion of *soft* information (e.g., human factors, personal opinions, hunches) in the forecasting process. Those factors are often omitted or downplayed when quantitative techniques are used because they are difficult or impossible to quantify. Quantitative techniques consist mainly of analyzing objective, or *hard*, data. They usually avoid personal biases that sometimes contaminate qualitative methods. In practice, either approach, or a combination of both approaches, might be used to develop a forecast.

The following pages present a variety of forecasting techniques that are classified as judgmental, time-series, or associative.

Judgmental forecasts Forecasts that use subjective inputs such as opinions from consumer surveys, sales staff, managers, executives, and experts.

Time-series forecasts Forecasts that project patterns identified in recent time-series observations.

Associative model Forecasting technique that uses explanatory variables to predict future demand.

Judgmental forecasts rely on analysis of subjective inputs obtained from various sources, such as consumer surveys, the sales staff, managers and executives, and panels of experts. Quite frequently, these sources provide insights that are not otherwise available.

Time-series forecasts simply attempt to project past experience into the future. These techniques use historical data with the assumption that the future will be like the past. Some models merely attempt to smooth out random variations in historical data; others attempt to identify specific patterns in the data and project or extrapolate those patterns into the future, without trying to identify causes of the patterns.

Associative models use equations that consist of one or more *explanatory* variables that can be used to predict demand. For example, demand for paint might be related to variables such as the price per gallon and the amount spent on advertising, as well as to specific characteristics of the paint (e.g., drying time, ease of cleanup).

3.7 QUALITATIVE FORECASTS

LO3.5 Describe four qualitative forecasting techniques.

In some situations, forecasters rely solely on judgment and opinion to make forecasts. If management must have a forecast quickly, there may not be enough time to gather and analyze quantitative data. At other times, especially when political and economic conditions are changing, available data may be obsolete, and more up-to-date information might not yet be available. Similarly, the introduction of new products and the redesign of existing products or packaging suffer from the absence of historical data that would be useful in forecasting. In such instances, forecasts are based on executive opinions, consumer surveys, opinions of the sales staff, and opinions of experts.

Executive Opinions

A small group of upper-level managers (e.g., in marketing, operations, and finance) may meet and collectively develop a forecast. This approach is often used as a part of long-range planning and new product development. It has the advantage of bringing together the considerable knowledge and talents of various managers. However, there is the risk that the view of one person will prevail, and the possibility that diffusing responsibility for the forecast over the entire group may result in less pressure to produce a good forecast.

Salesforce Opinions

Members of the sales staff or the customer service staff are often good sources of information because of their direct contact with consumers. They are often aware of any plans the customers may be considering for the future. There are, however, several drawbacks to using salesforce opinions. One is that staff members may be unable to distinguish between what customers would *like* to do and what they actually *will* do. Another is that these people are sometimes overly influenced by recent experiences. Thus, after several periods of low sales, their estimates may tend to become pessimistic. After several periods of good sales, they may tend to be too optimistic. In addition, if forecasts are used to establish sales quotas, there will be a conflict of interest because it is to the salesperson's advantage to provide low sales estimates.

Consumer Surveys

Because it is the consumers who ultimately determine demand, it seems natural to solicit input from them. In some instances, every customer or potential customer can be contacted. However, usually there are too many customers or there is no way to identify all potential customers. Therefore, organizations seeking consumer input usually resort to consumer surveys, which enable them to *sample* consumer opinions. The obvious advantage of consumer surveys is that they can tap information that might not be available elsewhere. On the other hand, a considerable amount of knowledge and skill is required to construct a survey, administer it, and correctly interpret the results for valid information. Surveys can be expensive and time-consuming. In addition, even under the best conditions, surveys of the general public must contend with the possibility of irrational behavior patterns. For example, much of the consumer's thoughtful information gathering before purchasing a new car is often undermined by the glitter of a new car showroom or a high-pressure sales pitch. Along the same lines, low response rates to a mail survey should—but often don't—make the results suspect.

If these and similar pitfalls can be avoided, surveys can produce useful information.

Other Approaches

A manager may solicit opinions from a number of other managers and staff people. Occasionally, outside experts are needed to help with a forecast. Advice may be needed on political or economic conditions in the United States or a foreign country, or some other aspect of importance with which an organization lacks familiarity.

Another approach is the **Delphi method**, an iterative process intended to achieve a consensus forecast. This method involves circulating a series of questionnaires among individuals who possess the knowledge and ability to contribute meaningfully. Responses are kept anonymous, which tends to encourage honest responses and reduces the risk that one person's opinion will prevail. Each new questionnaire is developed using the information extracted from the previous one, thus enlarging the scope of information on which participants can base their judgments.

The Delphi method has been applied to a variety of situations, not all of which involve forecasting. The discussion here is limited to its use as a forecasting tool.

As a forecasting tool, the Delphi method is useful for *technological* forecasting; that is, for assessing changes in technology and their impact on an organization. Often, the goal is to predict *when* a certain event will occur. For instance, the goal of a Delphi forecast might be to predict when video telephones might be installed in at least 50 percent of residential homes or when a vaccine for a disease might be developed and ready for mass distribution. For the most part, these are long-term, single-time forecasts, which usually have very little hard information to go by or data that are costly to obtain, so the problem does not lend itself to analytical techniques. Rather, judgments of experts or others who possess sufficient knowledge to make predictions are used.

Delphi method An iterative process in which managers and staff complete a series of questionnaires, each developed from the previous one, to achieve a consensus forecast.

3.8 FORECASTS BASED ON TIME-SERIES DATA

Time series A time-ordered sequence of observations taken at regular intervals.

A **time series** is a time-ordered sequence of observations taken at regular intervals (e.g., hourly, daily, weekly, monthly, quarterly, annually). The data may be measurements of demand, sales, earnings, profits, shipments, accidents, output, precipitation, productivity, or the consumer price index. Note that forecasts based on sales will understate demand when demand exceeds sales, causing shortages (stockouts) to occur. Forecasting techniques based on time-series data are made on the assumption that future values of the series can be estimated from past values. Although no attempt is made to identify variables that influence the series, these methods are widely used, often with quite satisfactory results.

Analysis of time-series data requires the analyst to identify the underlying behavior of the series. This can often be accomplished by merely *plotting the data* and visually examining the plot. One or more patterns might appear: trends, seasonal variations, cycles, or variations around an average. In addition, there will be random and perhaps irregular variations. These behaviors can be described as follows:

Trend A long-term upward or downward movement in data.

1. **Trend** refers to a long-term upward or downward movement in the data. Population shifts, changing incomes, and cultural changes often account for such movements.

Seasonality Short-term regular variations related to the calendar or time of day.

2. **Seasonality** refers to short-term, fairly regular variations generally related to factors such as the calendar or time of day. Restaurants, supermarkets, and theaters experience weekly and even daily “seasonal” variations.

Cycle Wavelike variations lasting more than one year.

3. **Cycles** are wavelike variations of more than one year’s duration. These are often related to a variety of economic, political, and even agricultural conditions.

Irregular variation Caused by unusual circumstances, not reflective of typical behavior.

4. **Irregular variations** are due to unusual circumstances such as severe weather conditions, strikes, or a major change in a product or service. They do not reflect typical behavior, and their inclusion in the series can distort the overall picture. Whenever possible, these should be identified and removed from the data.

Random variations Residual variations after all other behaviors are accounted for.

5. **Random variations** are residual variations that remain after all other behaviors have been accounted for.

These behaviors are illustrated in Figure 3.1. The small “bumps” in the plots represent random variability.

The remainder of this section describes the various approaches to the analysis of time-series data. Before turning to those discussions, one point should be emphasized: A demand forecast should be based on a time series of past *demand* rather than unit sales. Sales would not truly reflect demand if one or more *stockouts* occurred.

Naive Methods

Naive forecast A forecast for any period that equals the previous period’s actual value.

LO3.6 Use a naive method to make a forecast.

A simple but widely used approach to forecasting is the naive approach. A **naive forecast** uses a single previous value of a time series as the basis of a forecast. The naive approach can be used with a stable series (variations around an average), with seasonal variations, or with trend. With a stable series, the last data point becomes the forecast for the next period. Thus, if demand for a product last week was 20 cases, the forecast for this week is 20 cases. With seasonal variations, the forecast for this “season” is equal to the value of the series last “season.” For example, the forecast for demand for turkeys this Thanksgiving season is equal to demand for turkeys last Thanksgiving; the forecast of the number of checks cashed at a bank on the first day of the month next month is equal to the number of checks cashed on the first day of this month; and the forecast for highway traffic volume this Friday is equal to the highway traffic volume last Friday. For data with trend, the forecast is equal to the last value of the series plus or minus the difference between the last two

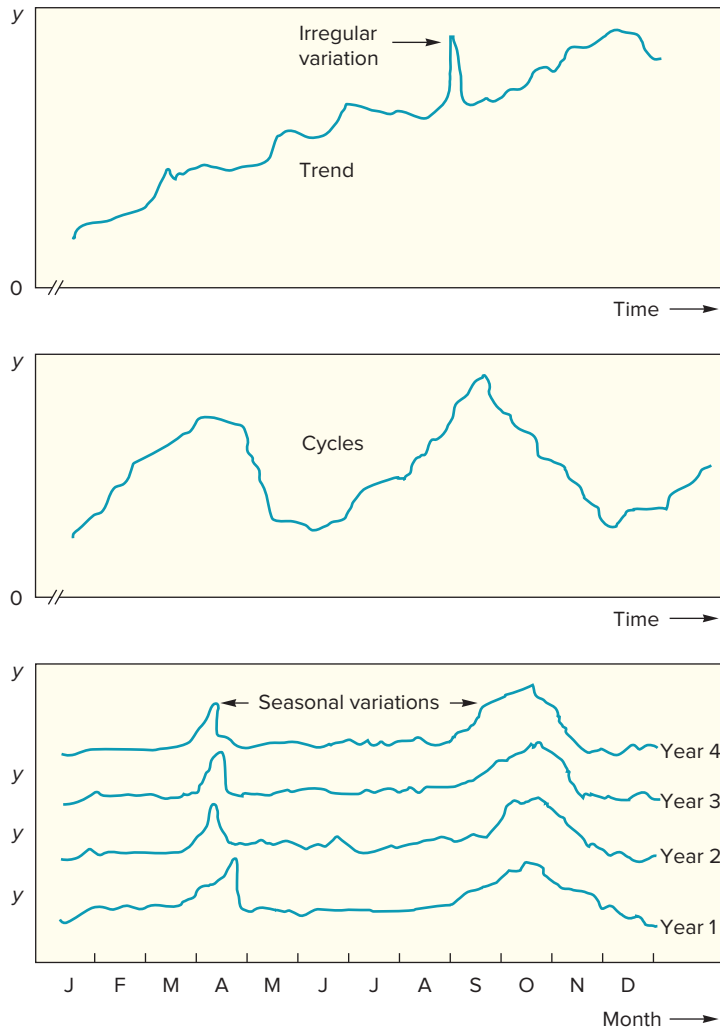

FIGURE 3.1 Trend, cyclical, and seasonal data plots, with random and irregular variations

values of the series. For example, suppose the last two values were 50 and 53. The next forecast would be 56:

Period	Actual	Change from Previous Value	Forecast
1	50		
2	53	+3	
3			53 + 3 = 56

Although at first glance the naive approach may appear *too* simplistic, it is nonetheless a legitimate forecasting tool. Consider the advantages: It has virtually no cost, it is quick and easy to prepare because data analysis is nonexistent, and it is easily understandable. The main objection to this method is its inability to provide highly accurate forecasts. However, if resulting accuracy is acceptable, this approach deserves serious consideration. Moreover, even if other forecasting techniques offer better accuracy, they will almost always involve a greater cost. The accuracy of a naive forecast can serve as a standard of comparison against which to judge the cost and accuracy of other techniques. Thus, managers must answer the question: Is the increased accuracy of another method worth the additional resources required to achieve that accuracy?

FIGURE 3.2 Averaging applied to three possible patterns



Techniques for Averaging

Historical data typically contain a certain amount of random variation, or *white noise*, that tends to obscure systematic movements in the data. This randomness arises from the combined influence of many—perhaps a great many—relatively unimportant factors, and it cannot be reliably predicted. Averaging techniques smooth variations in the data. Ideally, it would be desirable to completely remove any randomness from the data and leave only “real” variations, such as changes in the demand. As a practical matter, however, it is usually impossible to distinguish between these two kinds of variations, so the best one can hope for is that the small variations are random and the large variations are “real.”

Averaging techniques smooth fluctuations in a time series because the individual highs and lows in the data offset each other when they are combined into an average. A forecast based on an average thus tends to exhibit less variability than the original data (see Figure 3.2). This can be advantageous because many of these movements merely reflect random variability rather than a true change in the series. Moreover, because responding to changes in expected demand often entails considerable cost (e.g., changes in production rate, changes in the size of a workforce, inventory changes), it is desirable to avoid reacting to minor variations. Thus, minor variations are treated as random variations, whereas larger variations are viewed as more likely to reflect “real” changes, although these, too, are smoothed to a certain degree.

Averaging techniques generate forecasts that reflect recent values of a time series (e.g., the average value over the last several periods). These techniques work best when a series tends to vary around an average, although they also can handle step changes or gradual changes in the level of the series. Three techniques for averaging are described in this section:

1. Moving average
2. Weighted moving average
3. Exponential smoothing

Moving Average One weakness of the naive method is that the forecast just *traces* the actual data, with a lag of one period; it does not smooth at all. But by expanding the amount of historical data a forecast is based on, this difficulty can be overcome. A **moving average** forecast uses a *number* of the most recent actual data values in generating a forecast. The moving average forecast can be computed using the following equation:

$$F_t = MA_n = \frac{\sum_{i=1}^n A_{t-i}}{n} = \frac{A_{t-n} + \dots + A_{t-2} + A_{t-1}}{n} \quad (3-1)$$

where

- F_t = Forecast for time period t
- MA_n = n period moving average
- A_{t-i} = Actual value in period $t - i$
- n = Number of periods (data points) in the moving average

For example, MA_3 would refer to a three-period moving average forecast, and MA_5 would refer to a five-period moving average forecast.

Moving average Technique that averages a number of recent actual values, updated as new values become available.

LO3.7 Prepare a moving average forecast.

Computing a Moving Average

Compute a three-period moving average forecast given demand for shopping carts for the last five periods.

Period	Demand
1	42
2	40
3	43
4	40
5	41

} the 3 most recent demands

EXAMPLE 1

excel
mhhe.com/stevenson14e

$$F_6 = \frac{43 + 40 + 41}{3} = 41.33$$

If actual demand in period 6 turns out to be 38, the moving average forecast for period 7 would be

$$F_7 = \frac{40 + 41 + 38}{3} = 39.67$$

SOLUTION

Note that in a moving average, as each new actual value becomes available, the forecast is updated by adding the newest value and dropping the oldest and then recomputing the average. Consequently, the forecast “moves” by reflecting only the most recent values.

In computing a moving average, including a *moving total* column—which gives the sum of the n most current values from which the average will be computed—aids computations. To update the moving total: Subtract the oldest value from the newest value and add that amount to the moving total for each update.

Figure 3.3 illustrates a three-period moving average forecast plotted against actual demand over 31 periods. Note how the moving average forecast *lags* the actual values and how *smooth* the forecasted values are compared with the actual values.

The moving average can incorporate as many data points as desired. In selecting the number of periods to include, the decision maker must take into account that the number of data points in the average determines its sensitivity to each new data point: The fewer the data points in an average, the more sensitive (responsive) the average tends to be. (See Figure 3.4A.)

If responsiveness is important, a moving average with relatively few data points should be used. This will permit quick adjustment to, say, a step change in the data, but it also will

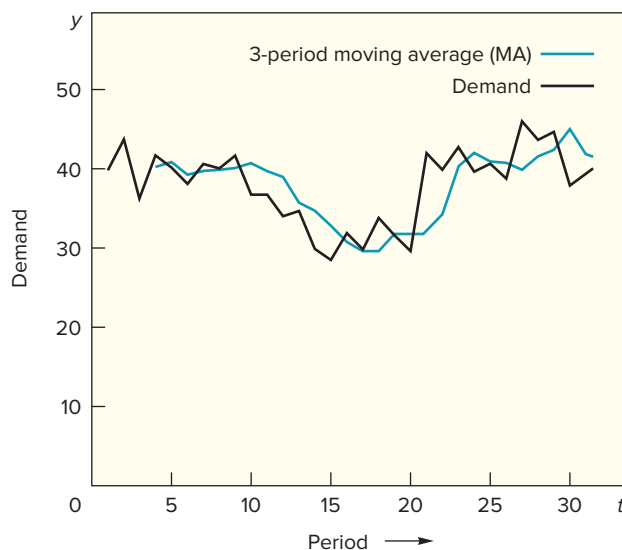
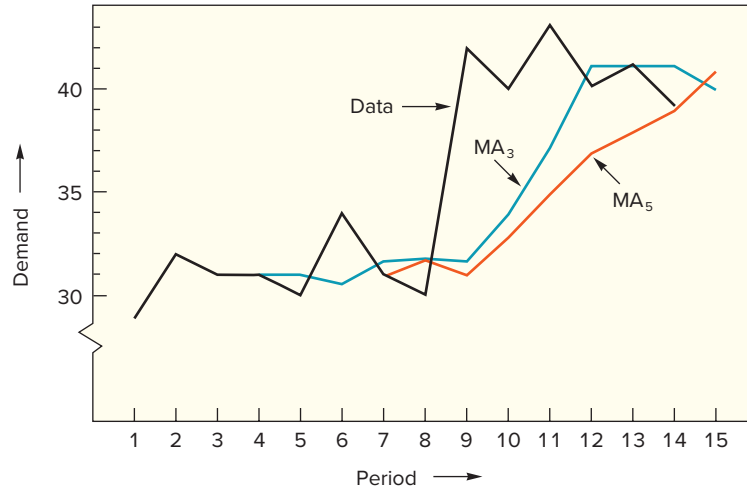

FIGURE 3.3

A moving average forecast tends to smooth and lag changes in the data

FIGURE 3.4A

The more periods in a moving average, the greater the forecast will lag changes in the data



cause the forecast to be somewhat responsive even to random variations. Conversely, moving averages based on more data points will smooth more but be less responsive to “real” changes. Hence, the decision maker must weigh the cost of responding more slowly to changes in the data against the cost of responding to what might simply be random variations. A review of forecast errors can help in this decision.

The advantages of a moving average forecast are that it is easy to compute and easy to understand. A possible disadvantage is that all values in the average are weighted equally. For instance, in a 10-period moving average, each value has a weight of $1/10$. Hence, the oldest value has the *same weight* as the most recent value. If a change occurs in the series, a moving average forecast can be slow to react, especially if there are a large number of values in the average. Decreasing the number of values in the average increases the weight of more recent values, but it does so at the expense of losing potential information from less recent values.

Weighted average More recent values in a series are given more weight in computing a forecast.

LO3.8 Prepare a weighted-average forecast.

Weighted Moving Average A **weighted average** is similar to a moving average, except that it typically assigns more weight to the most recent values in a time series. For instance, the most recent value might be assigned a weight of .40, the next most recent value a weight of .30, the next after that a weight of .20, and the next after that a weight of .10. Note that the weights must sum to 1.00, and that the heaviest weights are assigned to the most recent values.

$$F_t = w_{t-n}A_{t-n} + w_{t-n+1}A_{t-n+1} + \dots + w_{t-2}A_{t-2} + w_{t-1}A_{t-1} \quad (3-2)$$

where

w_{t-1} = Weight for period $t - 1$, etc.

A_{t-1} = Actual value for period $t - 1$, etc.

EXAMPLE 2

Excel
mhhe.com/stevenson14e

Computing a Weighted Moving Average

Given the following demand data,

- Compute a weighted average forecast using a weight of .40 for the most recent period, .30 for the next most recent, .20 for the next, and .10 for the next.
- If the actual demand for period 6 is 39, forecast demand for period 7 using the same weights as in part *a*.

Period	Demand
1	42
2	40
3	43
4	40
5	41

- a. $F_6 = .10(40) + .20(43) + .30(40) + .40(41) = 41.0$
 b. $F_7 = .10(43) + .20(40) + .30(41) + .40(39) = 40.2$

SOLUTION

Note that if four weights are used, only the *four most recent* demands are used to prepare the forecast.

The advantage of a weighted average over a simple moving average is that the weighted average is more reflective of the most recent occurrences. However, the choice of weights is somewhat arbitrary and generally involves the use of trial and error to find a suitable weighting scheme.

Exponential Smoothing Exponential smoothing is a sophisticated weighted averaging method that is still relatively easy to use and understand. Each new forecast is based on the previous forecast plus a percentage of the difference between that forecast and the actual value of the series at that point. That is:

$$\text{Next forecast} = \text{Previous forecast} + \alpha(\text{Actual} - \text{Previous forecast})$$

where (Actual – Previous forecast) represents the forecast error and α is a percentage of the error. More concisely,

$$F_t = F_{t-1} + \alpha(A_{t-1} - F_{t-1}) \quad (3-3a)$$

where

- F_t = Forecast for period t
- F_{t-1} = Forecast for the previous period (i.e., period $t - 1$)
- α = Smoothing constant (percentage, usually less than 50%)
- A_{t-1} = Actual demand or sales for the previous period

The smoothing constant α represents a percentage of the forecast error. Each new forecast is equal to the previous forecast plus a percentage of the previous error. For example, suppose the previous forecast was 42 units, actual demand was 40 units, and $\alpha = .10$. The new forecast would be computed as follows:

$$F_t = 42 + .10(40 - 42) = 41.8$$

Then, if the actual demand turns out to be 43, the next forecast would be

$$F_t = 41.8 + .10(43 - 41.8) = 41.92$$

An alternate form of Formula 3-3a reveals the weighting of the previous forecast and the latest actual demand:

$$F_t = (1 - \alpha)F_{t-1} + \alpha A_{t-1} \quad (3-3b)$$

For example, if $\alpha = .10$, this would be

$$F_t = .90F_{t-1} + .10A_{t-1}$$

The quickness of forecast adjustment to error is determined by the smoothing constant, α . The closer its value is to zero, the slower the forecast will be to adjust to forecast errors (i.e., the greater the smoothing). Conversely, the closer the value of α is to 1.00, the greater the responsiveness and the less the smoothing. This is illustrated in Figure 3.4B.

Exponential smoothing A weighted averaging method based on the previous forecast plus a percentage of the forecast error.

LO3.9 Prepare an exponential smoothing forecast.

FIGURE 3.4B

The closer α is to zero, the greater the smoothing

Period (t)	Actual Demand	$\alpha = .10$ Forecast	$\alpha = .40$ Forecast
1	42	—	—
2	40	42	42
3	43	41.8	41.2
4	40	41.92	41.92
5	41	41.73	41.15
6	39	41.66	41.09
7	46	41.39	40.25
8	44	41.85	42.55
9	45	42.07	43.13
10	38	42.35	43.88
11	40	41.92	41.53
12		41.73	40.92

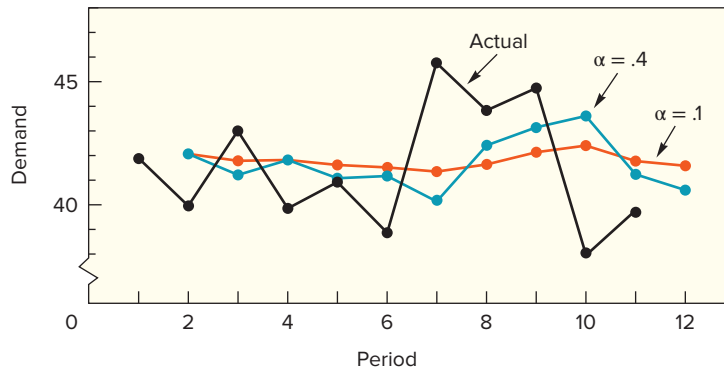

Selecting a smoothing constant is basically a matter of judgment or trial and error, using forecast errors to guide the decision. The goal is to select a smoothing constant that balances the benefits of smoothing random variations with the benefits of responding to real changes if and when they occur. Commonly used values of α range from .05 to .50. Low values of α are used when the underlying average tends to be stable; higher values are used when the underlying average is susceptible to change.

Some computer packages include a feature that permits automatic modification of the smoothing constant if the forecast errors become unacceptably large.

Exponential smoothing is one of the most widely used techniques in forecasting, partly because of its ease of calculation and partly because of the ease with which the weighting scheme can be altered—simply by changing the value of α .

Note: Exponential smoothing should begin several periods back to enable forecasts to adjust to the data, instead of starting one period back. A number of different approaches can be used to obtain a *starting forecast*, such as the average of the first several periods, a subjective estimate, or the first actual value as the forecast for period 2 (i.e., the naive approach). For simplicity, the naive approach is used in this book. In practice, using an average of, say, the first three values as a forecast for period 4 would provide a better starting forecast because that would tend to be more representative.

Other Forecasting Methods

You may find two other approaches to forecasting interesting. They are briefly described in this section.

Focus forecasting Using the forecasting method that demonstrates the best recent success.

Focus Forecasting Some companies use forecasts based on a “best recent performance” basis. This approach, called **focus forecasting**, was developed by Bernard T. Smith,

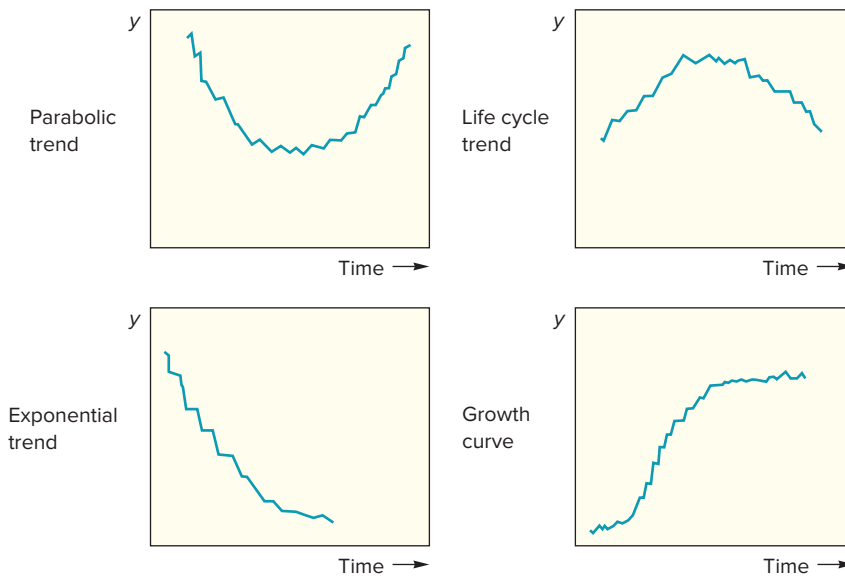
**FIGURE 3.5**

Graphs of some nonlinear trends

and is described in several of his books.¹ It involves the use of several forecasting methods (e.g., moving average, weighted average, and exponential smoothing) all being applied to the last few months of historical data after any irregular variations have been removed. The method that has the highest accuracy is then used to make the forecast for the next month. This process is used for each product or service, and is repeated monthly.

Diffusion Models When new products or services are introduced, historical data are not generally available on which to base forecasts. Instead, predictions are based on rates of product adoption and usage spread from other established products, using mathematical diffusion models. These models take into account such factors as market potential, attention from mass media, and word of mouth. Although the details are beyond the scope of this text, it is important to point out that diffusion models are widely used in marketing and to assess the merits of investing in new technologies.

Techniques for Trend

Analysis of trend involves developing an equation that will suitably describe trend (assuming that trend is present in the data). The trend component may be linear, or it may not. Some commonly encountered nonlinear trend types are illustrated in Figure 3.5. A simple plot of the data often can reveal the existence and nature of a trend. The discussion here focuses exclusively on *linear* trends because these are fairly common.

There are two important techniques that can be used to develop forecasts when trend is present. One involves use of a trend equation; the other is an extension of exponential smoothing.

Trend Equation A **linear trend equation** has the form

$$F_t = a + bt \quad (3-4)$$

where

- F_t = Forecast for period t
- a = Value of F_t at $t = 0$, which is the y intercept
- b = Slope of the line
- t = Specified number of time periods from $t = 0$

Linear trend equation $F_t = a + bt$, used to develop forecasts when trend is present.

LO3.10 Prepare a linear trend forecast.

¹See, for example, Bernard T. Smith and Virginia Brice, *Focus Forecasting: Computer Techniques for Inventory Control Revised for the Twenty-First Century* (Essex Junction, VT: Oliver Wight, 1984).

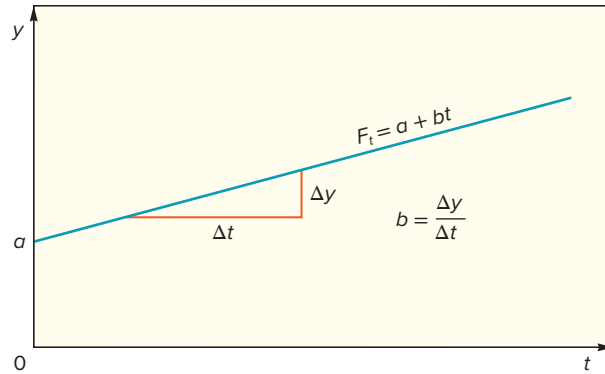

For example, consider the trend equation $F_t = 45 + 5t$. The value of F_t when $t = 0$ is 45, and the slope of the line is 5, which means that, on average, the value of F_t will increase by five units for each time period. If $t = 10$, the forecast, F_t , is $45 + 5(10) = 95$ units. The equation can be plotted by finding two points on the line. One can be found by substituting some value of t into the equation (e.g., $t = 10$) and then solving for F_t . The other point is a (i.e., F_t at $t = 0$). Plotting those two points and drawing a line through them yields a graph of the linear trend line.

The coefficients of the line, a and b , are based on the following two equations:

$$b = \frac{n \sum ty - \sum t \sum y}{n \sum t^2 - (\sum t)^2} \quad (3-5)$$

$$a = \frac{\sum y - b \sum t}{n} \text{ or } \bar{y} - b\bar{t} \quad (3-6)$$

where

n = Number of periods

y = Value of the time series

Note that these two equations are identical to those used for computing a linear regression line, except that t replaces x in the equations. Values for the trend equation can be obtained easily by using the Excel template.

EXAMPLE 3

excel

mhhe.com/stevenson14e

Obtaining and Using a Trend Equation

Cell phone sales for a California-based firm over the last 10 weeks are shown in the following table. Plot the data and visually check to see if a linear trend line would be appropriate. Then, determine the equation of the trend line, and predict sales for weeks 11 and 12.

Week	Unit Sales
1	700
2	724
3	720
4	728
5	740
6	742
7	758
8	750
9	770
10	775

SOLUTION

- a. A plot suggests that a linear trend line would be appropriate:

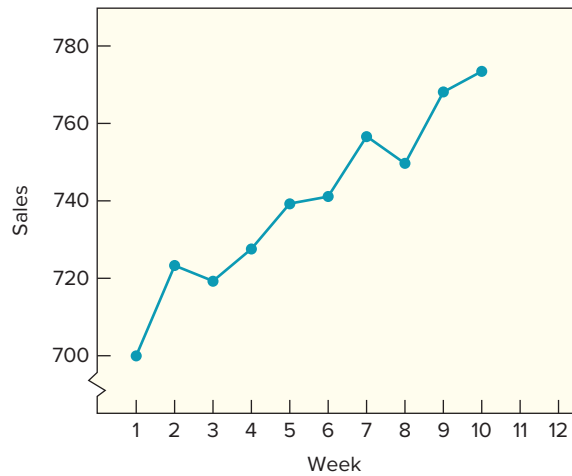

- b. The solution obtained by using the Excel template for linear trend is shown in Table 3.1.

$$b = 7.51 \text{ and } a = 699.40$$

The trend line is $F_t = 699.40 + 7.51t$, where $t = 0$ for period 0.

- c. Substituting values of t into this equation, the forecasts for the next two periods (i.e., $t = 11$ and $t = 12$) are:

$$F_{11} = 699.40 + 7.51(11) = 782.01$$

$$F_{12} = 699.40 + 7.51(12) = 789.52$$

- d. For purposes of illustration, the original data, the trend line, and the two projections (forecasts) are shown on the following graph:

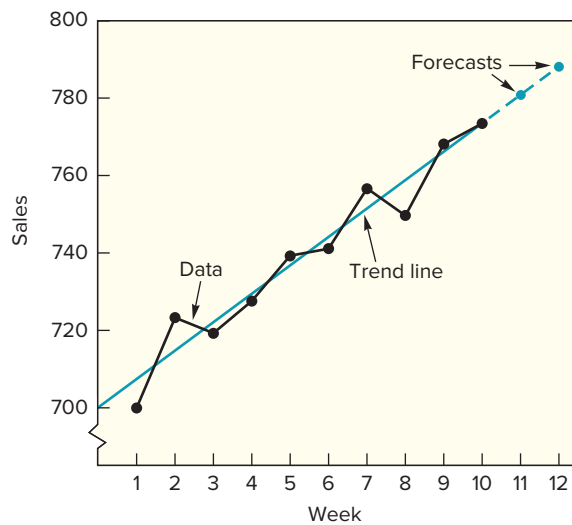
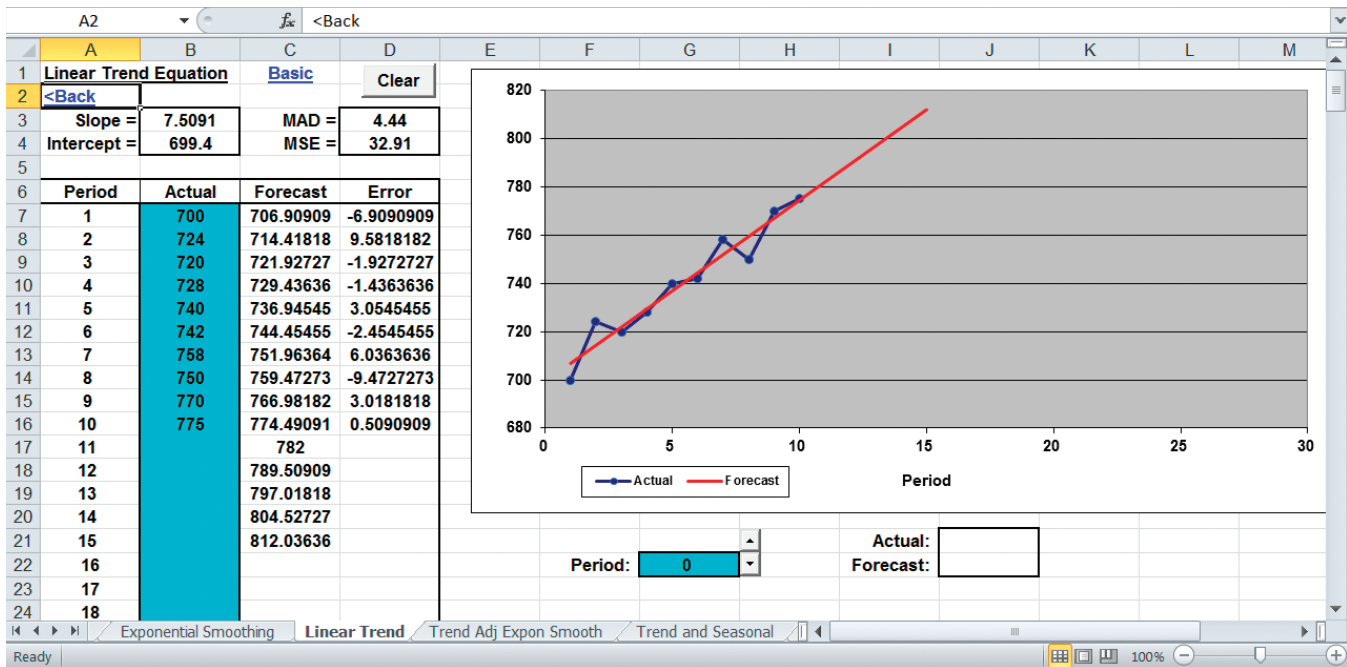

TABLE 3.1 Excel solution for Example 3



Source: Microsoft

Trend-Adjusted Exponential Smoothing

Trend-adjusted exponential smoothing Variation of exponential smoothing used when a time series exhibits a linear trend.

A variation of simple exponential smoothing can be used when a time series exhibits a *linear* trend. It is called **trend-adjusted exponential smoothing**, or sometimes *double smoothing*, to differentiate it from simple exponential smoothing, which is appropriate only when data vary around an average or have step or gradual changes. If a series exhibits a trend, and simple smoothing is used on it, the forecasts will all lag the trend: If the data are increasing, each forecast will be too low; if decreasing, each forecast will be too high.

LO3.11 Prepare a trend-adjusted exponential smoothing forecast.

The trend-adjusted forecast (TAF) is composed of two elements—a smoothed error and a trend factor.

$$TAF_{t+1} = S_t + T_t \tag{3-7}$$

where

S_t = Previous forecast plus smoothed error

T_t = Current trend estimate

and

$$\begin{aligned} S_t &= TAF_t + \alpha(A_t - TAF_t) \\ T_t &= T_{t-1} + \beta(TAF_t - TAF_{t-1} - T_{t-1}) \end{aligned} \tag{3-8}$$

where

α = Smoothing constant for average

β = Smoothing constant for trend

In order to use this method, one must select values of α and β (usually through trial and error) and make a starting forecast and an estimate of trend.

Using the cell phone data from the previous example (where it was concluded that the data exhibited a linear trend), use trend-adjusted exponential smoothing to obtain forecasts for periods 6 through 11, with $\alpha = .40$ and $\beta = .30$.

TABLE 3.2 Using the Excel template for trend-adjusted smoothing

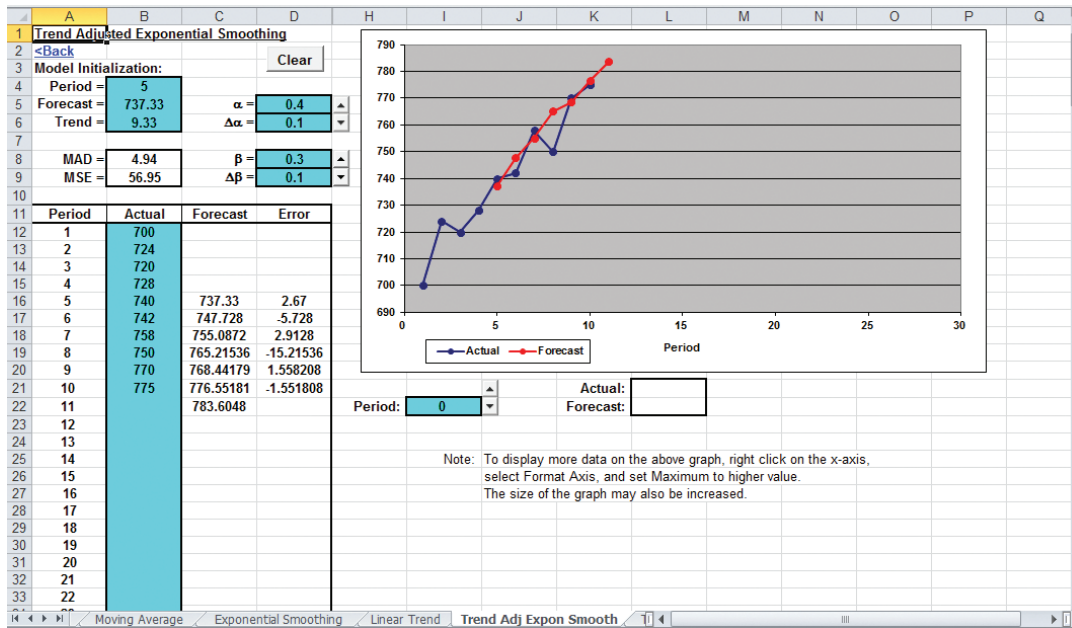

Source: Microsoft

The initial estimate of trend is based on the net change of 28 for the *three changes* from period 1 to period 4, for an average of 9.33. The Excel spreadsheet is shown in Table 3.2. Notice that an initial estimate of trend is estimated from the first four values and that the starting forecast (period 5) is developed using the previous (period 4) value of 728 plus the initial trend estimate:

$$\text{Starting forecast} = 728 + 9.33 = 737.33$$

Unlike a linear trend line, trend-adjusted smoothing has the ability to adjust to *changes* in trend. Of course, trend projections are much simpler with a trend line than with trend-adjusted forecasts, so a manager must decide which benefits are most important when choosing between these two techniques for trend.

Techniques for Seasonality

Seasonal variations in time-series data are regularly repeating upward or downward movements in series values that can be tied to recurring events. *Seasonality* may refer to regular annual variations. Familiar examples of seasonality are weather variations (e.g., sales of winter and summer sports equipment) and vacations or holidays (e.g., airline travel, greeting card sales, visitors at tourist and resort centers). The term *seasonal variation* is also applied to daily, weekly, monthly, and other regularly recurring patterns in data. For example, rush hour traffic occurs twice a day—incoming in the morning and outgoing in the late afternoon. Theaters and restaurants often experience weekly demand patterns, with demand higher later in the week. Banks may experience daily seasonal variations (heavier traffic during the noon hour and just before closing), weekly variations (heavier toward the end of the week), and monthly variations (heaviest around the beginning of the month because of Social Security, payroll, and welfare checks being cashed or deposited). Mail volume; sales of toys, beer, automobiles, and turkeys; highway usage; hotel registrations; and gardening also exhibit seasonal variations.

Seasonal variations Regularly repeating movements in series values that can be tied to recurring events.



Punchstock/Getty Images



Steve Mason/Getty Images

Seasonality in a time series is expressed in terms of the amount that actual values deviate from the *average* value of a series. If the series tends to vary around an average value, then seasonality is expressed in terms of that average (or a moving average); if trend is present, seasonality is expressed in terms of the trend value.

There are two different models of seasonality: additive and multiplicative. In the *additive* model, seasonality is expressed as a *quantity* (e.g., 20 units), which is added to or subtracted from the series average in order to incorporate seasonality. In the *multiplicative* model, seasonality is expressed as a *percentage* of the average (or trend) amount (e.g., 1.10), which is then used to multiply the value of a series to incorporate season-

ality. Figure 3.6 illustrates the two models for a linear trend line. In practice, businesses use the multiplicative model much more widely than the additive model, because it tends to be more representative of actual experience, so we will focus exclusively on the multiplicative model.

The seasonal percentages in the multiplicative model are referred to as **seasonal relatives** or *seasonal indexes*. Suppose that the seasonal relative for the quantity of toys sold in May at a store is 1.20. This indicates that toy sales for that month are 20 percent above the monthly average. A seasonal relative of .90 for July indicates that July sales are 90 percent of the monthly average.

Knowledge of seasonal variations is an important factor in retail planning and scheduling. Moreover, seasonality can be an important factor in capacity planning for systems that must be designed to handle peak loads (e.g., public transportation, electric power plants, highways, and bridges). Knowledge of the extent of seasonality in a time series can enable one to *remove* seasonality from the data (i.e., to seasonally adjust data) in order to discern other patterns

Seasonal relative Percentage of average or trend.

FIGURE 3.6

Seasonality: the additive and multiplicative models compared using a linear trend

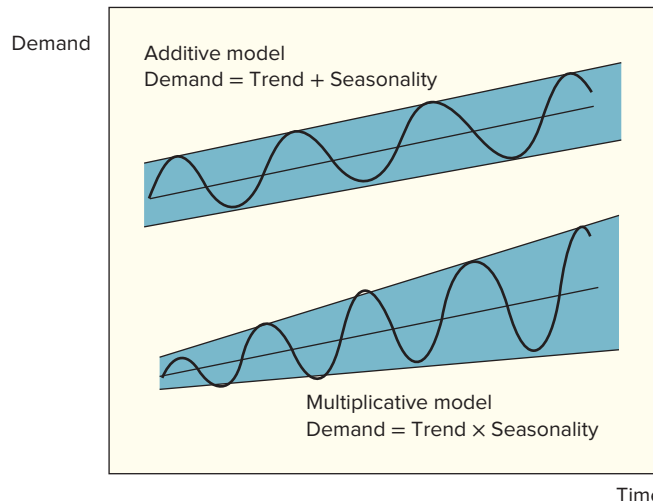

Time

or the lack of patterns in the series. Thus, one frequently reads or hears about “seasonally adjusted unemployment” and “seasonally adjusted personal income.”

The next section briefly describes how seasonal relatives are used.

Using Seasonal Relatives Seasonal relatives are used in two different ways in forecasting. One way is to *deseasonalize data*; the other way is to *incorporate seasonality in a forecast*.

To deseasonalize data is to remove the seasonal component from the data in order to get a clearer picture of the nonseasonal (e.g., trend) components. Deseasonalizing data is accomplished by *dividing* each data point by its corresponding seasonal relative (e.g., divide November demand by the November relative, divide December demand by the December relative, and so on).

Incorporating seasonality in a forecast is useful when demand has both trend (or average) and seasonal components. Incorporating seasonality can be accomplished in this way:

1. Obtain trend estimates for desired periods using a trend equation.
2. Add seasonality to the trend estimates by *multiplying* (assuming a multiplicative model is appropriate) these trend estimates by the corresponding seasonal relative (e.g., multiply the November trend estimate by the November seasonal relative, multiply the December trend estimate by the December seasonal relative, and so on).

Example 4 illustrates these two techniques.

LO3.12 Compute and use seasonal relatives.

a. Deseasonalizing Data and b. Using Trend and Seasonal Relatives to make a Forecast

A coffee shop owner wants to estimate demand for the next two quarters for hot chocolate. Sales data consist of trend and seasonality.

- Quarter relatives are 1.20 for the first quarter, 1.10 for the second quarter, 0.75 for the third quarter, and 0.95 for the fourth quarter. Use this information to deseasonalize sales for quarters 1 through 8.
- Using the appropriate values of quarter relatives and the equation $F_t = 124 + 7.5t$ for the trend component, estimate demand for periods 9 and 10.

EXAMPLE 4

eXcel
mhhe.com/stevenson14e

a.	Period	Quarter	Sales (gal.)	÷	Quarter Relative	=	Deseasonalized Sales
	1	1	158.4	÷	1.20	=	132.0
	2	2	153.0	÷	1.10	=	139.1
	3	3	110.0	÷	0.75	=	146.7
	4	4	146.3	÷	0.95	=	154.0
	5	1	192.0	÷	1.20	=	160.0
	6	2	187.0	÷	1.10	=	170.0
	7	3	132.0	÷	0.75	=	176.0
	8	4	173.8	÷	0.95	=	182.9

SOLUTION

- The trend values are:

$$\text{Period 9: } F_t = 124 + 7.5(9) = 191.5$$

$$\text{Period 10: } F_t = 124 + 7.5(10) = 199.0$$

Period 9 is a first quarter and period 10 is a second quarter. Multiplying each trend value by the appropriate quarter relative results in:

$$\text{Period 9: } 191.5(1.20) = 229.8$$

$$\text{Period 10: } 199.0(1.10) = 218.9$$

FIGURE 3.7

A centered moving average closely tracks the data

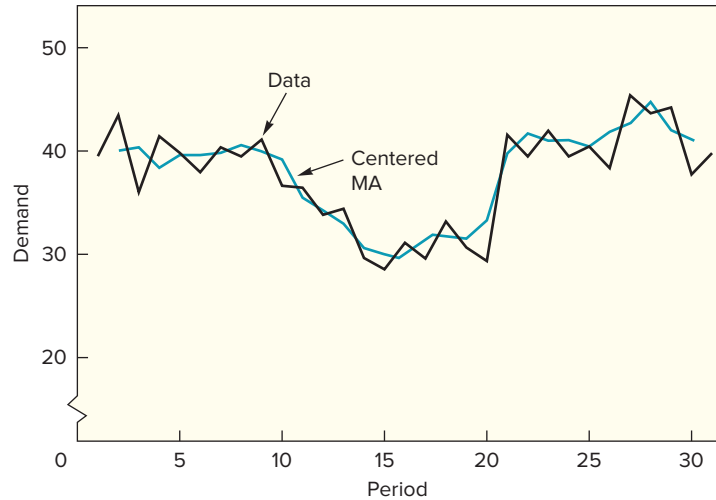

Centered moving average A moving average positioned at the center of the data that were used to compute it.

Computing Seasonal Relatives A widely used method for computing seasonal relatives involves the use of a **centered moving average**. This approach effectively accounts for any trend (linear or curvilinear) that might be present in the data. For example, Figure 3.7 illustrates how a three-period centered moving average closely tracks the data originally shown in Figure 3.3.

Manual computation of seasonal relatives using the centered moving average method is a bit cumbersome, so the use of software is recommended. Manual computation is illustrated in Solved Problem 4 at the end of the chapter. The Excel template (on the website) is a simple and convenient way to obtain values of seasonal relatives (indexes). Example 5 illustrates this approach.

For practical purposes, you can round the relatives to two decimal places. Thus, the seasonal (standard) index values are:

Day	Index
Tues	0.87
Wed	1.05
Thurs	1.20
Fri	1.37
Sat	1.24
Sun	0.53
Mon	0.75

Computing Seasonal Relatives Using the Simple Average Method The simple average (SA) method is an alternative way to compute seasonal relatives. Each seasonal relative is the average for that season divided by the average of all seasons. This method is illustrated in Example 5, where the seasons are days. Note that there is no need to standardize the relatives when using the SA method.

EXAMPLE 5



mhhe.com/stevenson14e

Computing Seasonal Relatives

The manager of a call center recorded the volume of calls received between 9 and 10 a.m. for 21 days and wants to obtain a seasonal index for each day for that hour.

Day	Volume	Day	Volume	Day	Volume
Tues	67	Tues	60	Tues	64
Wed	75	Wed	73	Wed	76
Thurs	82	Thurs	85	Thurs	87
Fri	98	Fri	99	Fri	96
Sat	90	Sat	86	Sat	88
Sun	36	Sun	40	Sun	44
Mon	55	Mon	52	Mon	50

SOLUTION

Compute Seasonal Indexes

<Back

Number of "seasons" = 7

Season	Average Index	Standard Index
Tues	0.8688	0.8690
Wed	1.0460	1.0463
Thur	1.1980	1.1983
Fri	1.3648	1.3652
Sat	1.2383	1.2386
Sun	0.5339	0.5341
Mon	0.7484	0.7486

Period	Season	Actual	MA	Center	Index
1	Tues	67			
2	Wed	75			
3	Thur	82			
4	Fri	98		71.857143	1.3638171
5	Sat	90		70.857143	1.2701613
6	Sun	38		70.571429	0.5101215
7	Mon	55	71.857143	71	0.7746479
8	Tues	60	70.857143	71.142857	0.8433735
9	Wed	73	70.571429	70.571429	1.034413
10	Thur	85	71	71.142857	1.1947791
11	Fri	99	71.142857	70.714286	1.4
12	Sat	86	70.571429	71.285714	1.2064128
13	Sun	40	71.142857	71.714286	0.5577689
14	Mon	62	70.714286	72	0.7222222
15	Tues	64	71.285714	71.571429	0.8942116
16	Wed	76	71.714286	71.857143	1.0576541
17	Thur	87	72	72.428571	1.2011834
18	Fri	96	71.571429	72.142857	1.3306931
19	Sat	88	71.857143		
20	Sun	44	72.428571		
21	Mon	50	72.142857		

Clear

Source: Microsoft

Computing Seasonal Relatives Using the Simple Averaging Method

EXAMPLE 6

This example illustrates the steps needed to compute seasonal relatives using the SA method.

SOLUTION



Step 1: Compute the season averages

Step 3: Compute the SA relatives

Quarter	Year 1	Year 2	Year 3	Quarter Total	Quarter Average	Quarter Relative
1	20	23	17	60	20	20/20 = 1.00
2	10	12	8	30	10	10/20 = 0.50
3	25	17	22	66	22	22/20 = 1.10
4	28	26	30	84	28	28/20 = 1.40
					80	4.00

Average of quarter averages = 80/4 = 20

Step 2: Compute the overall average

The obvious advantage of the SA method compared to the centered MA method is the simplicity of computations. When the data have a stationary mean (i.e., variation around an average), the SA method works quite well, providing values of relatives that are quite close to those obtained using the centered MA method, which is generally accepted as accurate. Conventional wisdom is that the SA method should not be used when linear trend is present in the data. However, it can be used to obtain fairly good values of seasonal relatives as long as the ratio of the intercept to the slope is large, or when variations are large relative to the slope, shown as follows. Also, the larger the ratio, the smaller the error. The general relationship is illustrated in the following figure.

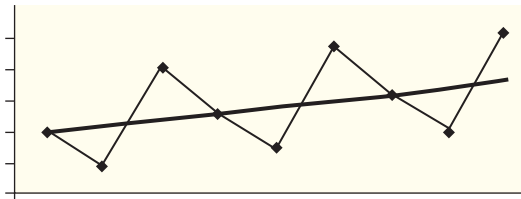

Variations are large relative to the slope of the line, so it is okay to use the SA method.

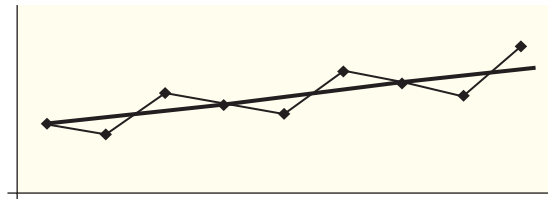

Variations are small relative to the slope of the line, so it is not okay to use the SA method.

Techniques for Cycles

Cycles are up-and-down movements similar to seasonal variations but of longer duration—say, two to six years between peaks. When cycles occur in time-series data, their frequent irregularity makes it difficult or impossible to project them from past data because turning points are difficult to identify. A short moving average or a naive approach may be of some value, although both will produce forecasts that lag cyclical movements by one or several periods.

The most commonly used approach is explanatory: Search for another variable that relates to, and *leads*, the variable of interest. For example, the number of housing starts (i.e., permits to build houses) in a given month often is an indicator of demand a few months later for products and services directly tied to construction of new homes (landscaping; sales of washers and dryers, carpeting, and furniture; new demands for shopping, transportation, schools). Thus, if an organization is able to establish a high correlation with such a *leading variable* (i.e., changes in the variable precede changes in the variable of interest), it can develop an equation that describes the relationship, enabling forecasts to be made. It is important that a persistent relationship exists between the two variables. Moreover, the higher the correlation, the better the chances that the forecast will be on target.

3.9 ASSOCIATIVE FORECASTING TECHNIQUES

Associative techniques rely on identification of related variables that can be used to predict values of the variable of interest. For example, sales of beef may be related to the price per pound charged for beef and the prices of substitutes such as chicken, pork, and lamb; real estate prices are usually related to property location and square footage; and crop yields are related to soil conditions and the amounts and timing of water and fertilizer applications.

The essence of associative techniques is the development of an equation that summarizes the effects of **predictor variables**. The primary method of analysis is known as **regression**. A brief overview of regression should suffice to place this approach into perspective relative to the other forecasting approaches described in this chapter.

Simple Linear Regression

The simplest and most widely used form of regression involves a linear relationship between two variables. A plot of the values might appear like that in Figure 3.8. The object in linear regression is to obtain an equation of a straight line that minimizes the sum of squared vertical

Predictor variables Variables that can be used to predict values of the variable of interest.

Regression Technique for fitting a line to a set of points.

LO3.13 Compute and use regression and correlation coefficients.

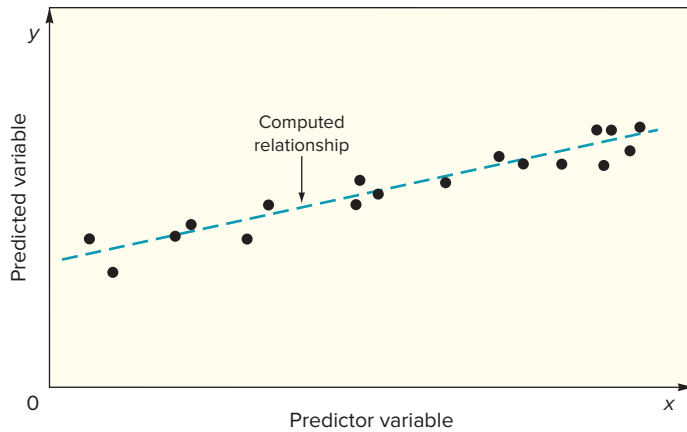
**FIGURE 3.8**

A straight line is fitted to a set of sample points

deviations of data points from the line (i.e., the *least squares criterion*). This **least squares line** has the equation

$$y_c = a + bx \quad (3-9)$$

where

y_c = Predicted (dependent) variable

x = Predictor (independent) variable

b = Slope of the line

a = Value of y_c when $x = 0$ (i.e., the height of the line at the y intercept)

(Note: It is conventional to represent values of the predicted variable on the y axis and values of the predictor variable on the x axis.) Figure 3.9 is a general graph of a linear regression line.

The coefficients a and b of the line are based on the following two equations:

$$b = \frac{n(\sum xy) - (\sum x)(\sum y)}{n(\sum x^2) - (\sum x)^2} \quad (3-10)$$

$$a = \frac{\sum y - b \sum x}{n} \text{ or } \bar{y} - b\bar{x} \quad (3-11)$$

where

n = Number of paired observations

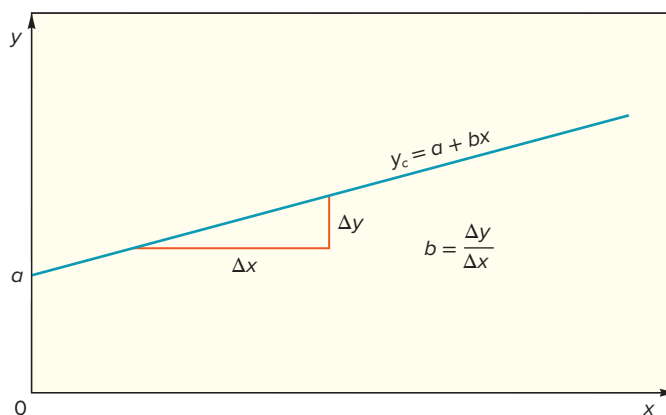

The line intersects the y axis where $y = a$. The slope of the line = b .

FIGURE 3.9

Equation of a straight line: The line represents the average (expected) values of variable y given values of variable x

EXAMPLE 7

excel
mhhe.com/stevenson14e

Determining a Regression Equation

Healthy Hamburgers has a chain of 12 stores in northern Illinois. Sales figures and profits for the stores are given in the following table. Obtain a regression equation for the data, and predict profit for a store assuming sales of \$10 million.

Unit Sales, x (in \$ millions)	Profits, y (in \$ millions)
\$7	\$0.15
2	0.10
6	0.13
4	0.15
14	0.25
15	0.27
16	0.24
12	0.20
14	0.27
20	0.44
15	0.34
7	0.17

SOLUTION

First, plot the data and decide if a linear model is reasonable. (That is, do the points seem to scatter around a straight line? Figure 3.10 suggests they do.) Next, using the appropriate Excel template on the text website, obtain the regression equation $y_c = 0.0506 + 0.0159x$ (see Table 3.3). For sales of $x = 10$ (i.e., 10 million), estimated profit is $y_c = 0.0506 + 0.0159(10) = .2099$, or \$209,900. (Substituting $x = 0$ into the equation to produce a predicted profit of \$50,600 may appear strange because it seems to suggest that amount of profit will occur with no sales. However, the value of $x = 0$ is *outside the range of observed values*. The regression line should be used only for the range of values from which it was developed; the relationship may be nonlinear outside that range. The purpose of the a value is simply to establish the height of the line where it crosses the y axis.)

FIGURE 3.10

A linear model seems reasonable

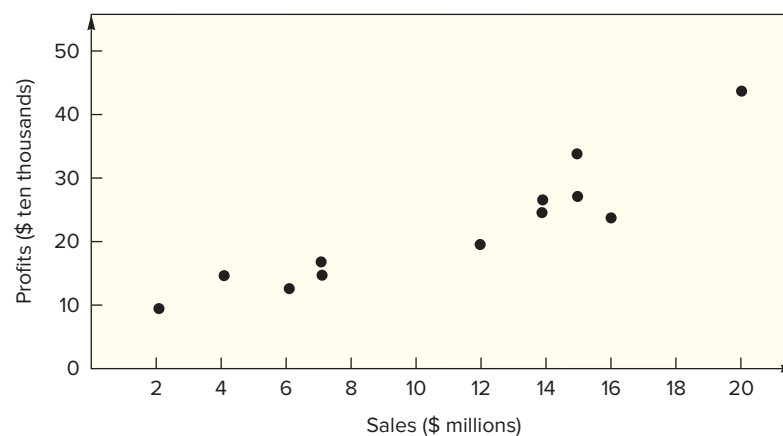

One indication of how accurate a prediction might be for a linear regression line is the amount of scatter of the data points around the line. If the data points tend to be relatively close to the line, predictions using the linear equation will tend to be more accurate than if the data points are widely scattered. The scatter can be summarized using the **standard error of estimate**. It can be computed by finding the vertical difference between each data point and the

Standard error of estimate A measure of the scatter of points around a regression line.

TABLE 3.3 Using the Excel template for linear regression

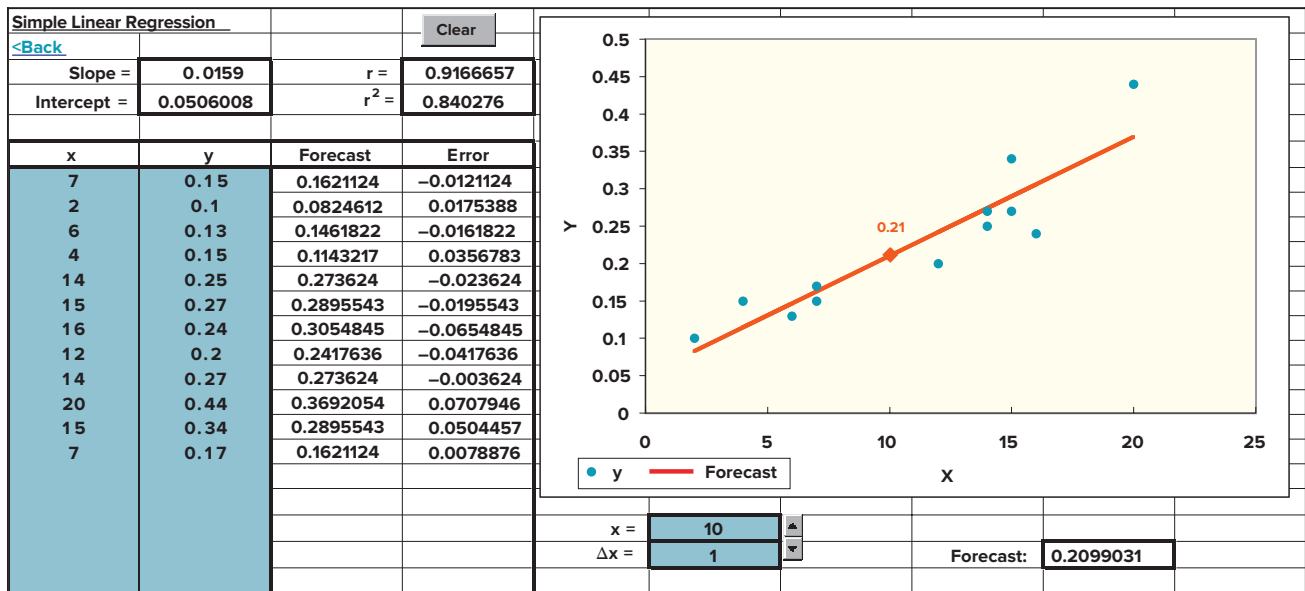

Source: Microsoft

computed value of the regression equation for that value of x , squaring each difference, adding the squared differences, dividing by $n - 2$, and then finding the square root of that value.

$$S_e = \sqrt{\frac{\sum(y - y_c)^2}{n - 2}} \tag{3-12}$$

where

S_e = Standard error of estimate

y = y value of each data point and y_c is the computed value at that point.

n = Number of data points

For the data given in Table 3.3, the error column shows the $y - y_c$ differences. Squaring each error and summing the squares yields .01659. Hence, the standard error of estimate is

$$S_e = \sqrt{\frac{.01659}{12 - 2}} = .0407 \text{ million}$$

One application of regression in forecasting relates to the use of indicators. These are uncontrollable variables that tend to lead or precede changes in a variable of interest. For example, changes in the Federal Reserve Board’s discount rate may influence certain business activities. Similarly, an increase in energy costs can lead to price increases for a wide range of products and services. Careful identification and analysis of indicators may yield insight into possible future demand in some situations. There are numerous published indexes and websites from which to choose.² These include:

- Net change in inventories on hand and on order
- Interest rates for commercial loans
- Industrial output
- Consumer price index (CPI)
- The wholesale price index
- Stock market prices

²See, for example, *The National Bureau of Economic Research, The Survey of Current Business, The Monthly Labor Review, and Business Conditions Digest.*

Other potential indicators are population shifts, local political climates, and activities of other firms (e.g., the opening of a shopping center may result in increased sales for nearby businesses). Three conditions are required for an indicator to be valid:

1. The relationship between movements of an indicator and movements of the variable should have a logical explanation.
2. Movements of the indicator must precede movements of the dependent variable by enough time so that the forecast isn't outdated before it can be acted upon.
3. A fairly high correlation should exist between the two variables.

Correlation A measure of the strength and direction of relationship between two variables.

Correlation measures the strength and direction of relationship between two variables. Correlation can range from -1.00 to $+1.00$. A correlation of $+1.00$ indicates that changes in one variable are always matched by changes in the other; a correlation of -1.00 indicates that increases in one variable are matched by decreases in the other; and a correlation close to zero indicates little *linear* relationship between two variables. The correlation between two variables can be computed using the equation

$$r = \frac{n(\sum xy) - (\sum x)(\sum y)}{\sqrt{n(\sum x^2) - (\sum x)^2} \sqrt{n(\sum y^2) - (\sum y)^2}} \quad (3-13)$$

The square of the correlation coefficient, r^2 , provides a measure of the percentage of variability in the values of y that is “explained” by the independent variable. The possible values of r^2 range from 0 to 1.00. The closer r^2 is to 1.00, the greater the percentage of explained variation. A high value of r^2 , say .80 or more, would indicate that the independent variable is a good predictor of values of the dependent variable. A low value, say .25 or less, would indicate a poor predictor, and a value between .25 and .80 would indicate a moderate predictor.

Comments on the Use of Linear Regression Analysis

Use of simple regression analysis implies that certain assumptions have been satisfied. Basically, these are as follows:

- Variations around the line are random. If they are random, no patterns such as cycles or trends should be apparent when the line and data are plotted.
- Deviations around the average value (i.e., the line) should be normally distributed. A concentration of values close to the line with a small proportion of larger deviations supports the assumption of normality.
- Predictions are being made only within the range of observed values.

If the assumptions are satisfied, regression analysis can be a powerful tool. To obtain the best results, observe the following:

- Always plot the data to verify that a linear relationship is appropriate.
- The data may be time-dependent. Check this by plotting the dependent variable versus time; if patterns appear, use analysis of time series instead of regression, or use time as an independent variable as part of a *multiple regression analysis*.
- A small correlation may imply that other variables are important.

In addition, note these weaknesses of regression:

- Simple linear regression applies only to linear relationships with *one* independent variable.
- One needs a considerable amount of data to establish the relationship—in practice, 20 or more observations.
- All observations are weighted equally.

Determining a Regression Equation

EXAMPLE 8

excel
mhhe.com/stevenson14e

Sales of new houses and three-month lagged unemployment are shown in the following table. Determine if unemployment levels can be used to predict demand for new houses and, if so, derive a predictive equation.

Period	1	2	3	4	5	6	7	8	9	10	11
Units sold	20	41	17	35	25	31	38	50	15	19	14
Unemployment % (three-month lag)	7.2	4.0	7.3	5.5	6.8	6.0	5.4	3.6	8.4	7.0	9.0

SOLUTION

- Plot the data to see if a *linear* model seems reasonable. In this case, a linear model seems appropriate *for the range of the data*.

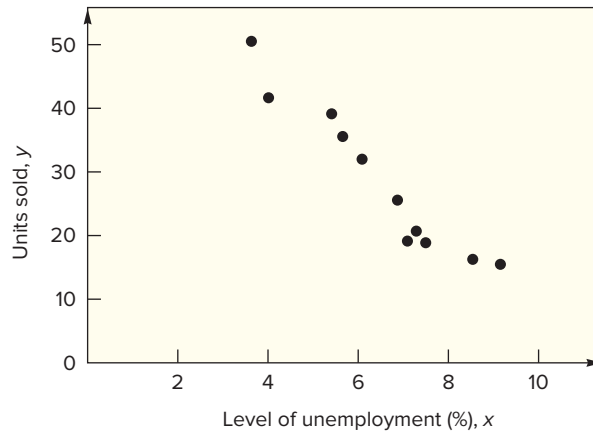

- Check the correlation coefficient to confirm that it is not close to zero using the web-site template, and then obtain the regression equation:

$$r = -.966$$

This is a fairly high negative correlation. The regression equation is

$$y = 71.85 - 6.91x$$

Note that the equation pertains only to unemployment levels in the range 3.6 to 9.0, because sample observations covered only that range.



J Edwards Photography/Shutterstock



Rochester, New York’s Highland Park is home to the largest collection of lilacs in the United States, with over 1,200 plants. About a half million visitors now come to the park each spring to enjoy the lilacs and other plants, as well as the Lilac Festival. It is interesting to note that over the years the lilacs have been trending toward earlier blooming, as shown in the graphs, perhaps due to global warming.

Source: *Rochester Democrat and Chronicle*, Dec. 21, 2018, p.1, p.11.

Questions

1. Do you think there is a correlation between blooming date and temperature?
2. Although each graph shows a definite linear trend, based on the data in the graphs, the trend lines probably shouldn’t be used to predict when the blooms will occur in any given year. Explain the reason for not doing that.
3. Park employees make their prediction each year a few months ahead of when they think the plants will bloom, and when the festival should occur. However, a bout of unusually warm or cold weather can alter the actual blooming times. What businesses are likely to be impacted by the festival, and what affect might a change in bloom time have on some of them?

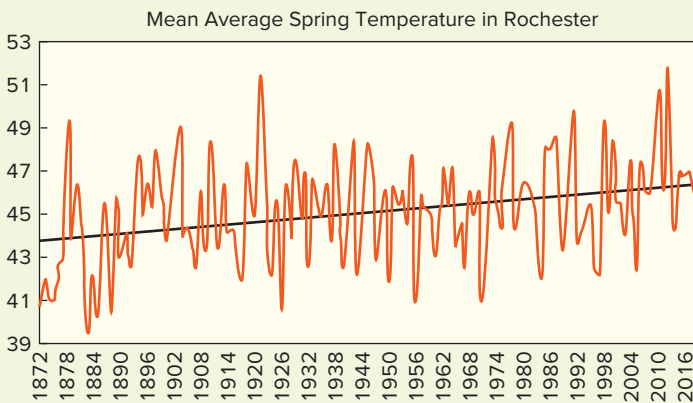
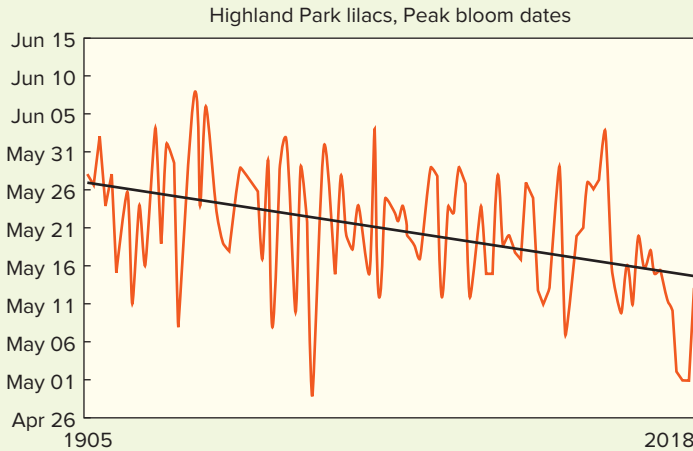

zatvornik/Shutterstock

Nonlinear and Multiple Regression Analysis

Simple linear regression may prove inadequate to handle certain problems because a linear model is inappropriate or because more than one predictor variable is involved. When nonlinear relationships are present, you should employ nonlinear regression; models that involve more than one predictor require the use of multiple regression analysis. While these analyses are beyond the scope of this text, you should be aware that they are often used. Multiple regression forecasting substantially increases data requirements.

3.10 FORECAST ACCURACY

Accuracy and control of forecasts is a vital aspect of forecasting, so forecasters want to minimize forecast errors. However, the complex nature of most real-world variables makes it almost impossible to correctly predict future values of those variables on a regular basis. Moreover, because random variation is always present, there will always be some residual

error, even if all other factors have been accounted for. Consequently, it is important to include an indication of the extent to which the forecast might deviate from the value of the variable that actually occurs. This will provide the forecast user with a better perspective on how far off a forecast might be.

Decision makers will want to include accuracy as a factor when choosing among different techniques, along with cost. Accurate forecasts are necessary for the success of daily activities of every business organization. Forecasts are the basis for an organization's schedules, and unless the forecasts are accurate, schedules will be generated that may provide for too few or too many resources, too little or too much output, the wrong output, or the wrong timing of output, all of which can lead to additional costs, dissatisfied customers, and headaches for managers.

Some forecasting applications involve a series of forecasts (e.g., weekly revenues), whereas others involve a single forecast that will be used for a one-time decision (e.g., the size of a power plant). When making periodic forecasts, it is important to monitor forecast errors to determine if the errors are within reasonable bounds. If they are not, it will be necessary to take corrective action.



“I recommend our ‘wild’ expectations be downgraded to ‘great.’”

Mike Baldwin/Cornered

Forecast **error** is the difference between the value that occurs and the value that was predicted for a given time period. Hence, Error = Actual – Forecast:

$$e_t = A_t - F_t \quad (3-14)$$

where

t = Any given time period

Positive errors result when the forecast is too low, while negative errors occur when the forecast is too high. For example, if actual demand for a week is 100 units, and forecast demand was 90 units, the forecast was too low. The error is $100 - 90 = +10$.

Forecast errors influence decisions in two somewhat different ways. One is in making a choice between various forecasting alternatives, and the other is in evaluating the success or failure of a technique in use. We shall begin by examining ways to summarize forecast error over time, and see how that information can be applied to compare forecasting alternatives.

Error Difference between the actual value and the value that was predicted for a given period.



HIGH FORECASTS CAN BE BAD NEWS

Overly optimistic forecasts by retail store buyers can easily lead retailers to overorder, resulting in bloated inventories. When that happens, there is pressure on stores to cut prices in order to move the excess merchandise. Although customers delight in these markdowns, retailer profits generally suffer. Furthermore, retailers

will naturally cut back on new orders while they work off their inventories, creating a ripple effect that hits the entire supply chain, from shippers, to producers, to suppliers of raw materials. Moreover, the cutbacks to the supply chain could be misinterpreted. The message is clear: Overly optimistic forecasts can be bad news.

LO3.14 Summarize forecast errors and use summaries to make decisions.

Mean absolute deviation (MAD) The average absolute forecast error.

Mean squared error (MSE) The average of squared forecast errors.

Mean absolute percent error (MAPE) The average absolute percent error.

Summarizing Forecast Accuracy

Forecast accuracy is a significant factor when deciding among forecasting alternatives. Accuracy is based on the historical error performance of a forecast.

Three commonly used measures for summarizing historical errors are the **mean absolute deviation (MAD)**, the **mean squared error (MSE)**, and the **mean absolute percent error (MAPE)**. MAD is the average absolute error, MSE is the average of squared errors, and MAPE is the average absolute percent error. The formulas used to compute MAD,³ MSE, and MAPE are as follows:

$$MAD = \frac{\sum |Actual_t - Forecast_t|}{n} \quad (3-15)$$

$$MSE = \frac{\sum (Actual_t - Forecast_t)^2}{n - 1} \quad (3-16)$$

$$MAPE = \frac{\sum \frac{|Actual_t - Forecast_t|}{Actual_t} \times 100}{n} \quad (3-17)$$

Example 9 illustrates the computation of MAD, MSE, and MAPE.

EXAMPLE 9

Computing MAD, MSE, and MAPE

Compute MAD, MSE, and MAPE for the following data, showing actual and forecasted numbers of accounts serviced.

Period	Actual	Forecast	A - F (Error)	Error	Error ²	[Error ÷ Actual] × 100
1	217	215	2	2	4	.92%
2	213	216	-3	3	9	1.41
3	216	215	1	1	1	.46
4	210	214	-4	4	16	1.90
5	213	211	2	2	4	.94
6	219	214	5	5	25	2.28
7	216	217	-1	1	1	.46
8	212	216	-4	4	16	1.89
			-2	22	76	10.26%

SOLUTION

Using the figures shown in the table,

$$MAD = \frac{\sum |e|}{n} = \frac{22}{8} = 2.75$$

$$MSE = \frac{\sum e^2}{n - 1} = \frac{76}{8 - 1} = 10.86$$

$$MAPE = \frac{\sum \left[\frac{|e|}{Actual} \times 100 \right]}{n} = \frac{10.26\%}{8} = 1.28\%$$

³The absolute value, represented by the two vertical lines in Formula 3-2, ignores minus signs; all data are treated as positive values. For example, -2 becomes +2.

From a computational standpoint, the difference between these measures is that MAD weights all errors evenly, MSE weights errors according to their *squared* values, and MAPE weights according to *relative* error.

One use for these measures is to compare the accuracy of alternative forecasting methods. For instance, a manager could compare the results to determine which one yields the *lowest* MAD, MSE, or MAPE for a given set of data. Another use is to track error performance over time to decide if attention is needed. Is error performance getting better or worse, or is it staying about the same?

In some instances, historical error performance is secondary to the ability of a forecast to respond to changes in data patterns. Choice among alternative methods would then focus on the cost of not responding quickly to a change relative to the cost of responding to changes that are not really there (i.e., random fluctuations).

Overall, the operations manager must settle on the relative importance of historical performance versus responsiveness and whether to use MAD, MSE, or MAPE to measure historical performance. MAD is the easiest to compute, but weights errors linearly. MSE squares errors, thereby giving more weight to larger errors, which typically cause more problems. MAPE should be used when there is a need to put errors in perspective. For example, an error of 10 in a forecast of 15 is huge. Conversely, an error of 10 in a forecast of 10,000 is insignificant. Hence, to put large errors in perspective, MAPE would be used. Another use of MAPE is when there is a need to compare forecast errors for *different* products or services. One example would be forecasts for store brands versus national brands.

3.11 MONITORING FORECAST ERROR

Many forecasts are made at regular intervals (e.g., weekly, monthly, quarterly). Because forecast errors are the rule rather than the exception, there will be a succession of forecast errors. Tracking the forecast errors and analyzing them can provide useful insight on whether forecasts are performing satisfactorily.

There are a variety of possible sources of forecast errors, including the following:

1. The model may be inadequate due to (a) the omission of an important variable, (b) a change or shift in the variable that the model cannot deal with (e.g., the sudden appearance of a trend or cycle), or (c) the appearance of a new variable (e.g., new competitor).
2. Irregular variations may occur due to severe weather or other natural phenomena, temporary shortages or breakdowns, catastrophes, or similar events.
3. Random variations. Randomness is the inherent variation that remains in the data after all causes of variation have been accounted for. There are always random variations.

A forecast is generally deemed to perform adequately when the errors exhibit only random variations. Hence, the key to judging when to reexamine the validity of a particular forecasting technique is whether forecast errors are random. If they are not random, it is necessary to investigate to determine which of the other sources is present and how to correct the problem.

A very useful tool for detecting nonrandomness in errors is a **control chart**. Errors are plotted on a control chart in the order that they occur, such as the one depicted in Figure 3.11. The center line of the chart represents an error of zero. Note the two other lines, one above

LO3.15 Construct control charts and use them to monitor forecast errors.

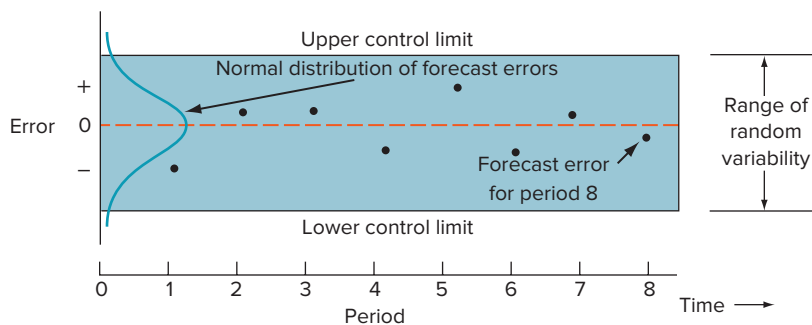

Control chart A visual tool for monitoring forecast errors.

FIGURE 3.11
Conceptual representation
of a control chart

FIGURE 3.12 Examples of nonrandomness

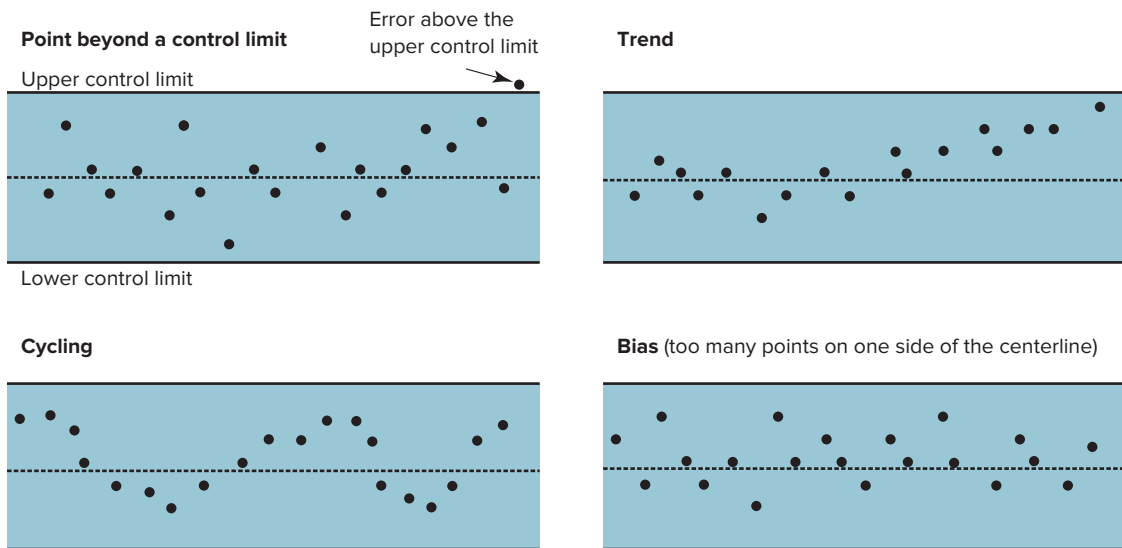

and one below the center line. They are called the upper and lower control limits because they represent the upper and lower ends of the range of acceptable variation for the errors.

In order for the forecast errors to be judged “in control” (i.e., random), two things are necessary. One is that all errors are within the control limits. The other is that no patterns (e.g., trends, cycles, noncentered data) are present. Both can be accomplished by inspection. Figure 3.12 illustrates some examples of nonrandom errors.

Technically speaking, one could determine if any values exceeded either control limit without actually plotting the errors, but the visual detection of patterns generally requires plotting the errors, so it is best to construct a control chart and plot the errors on the chart.

To construct a control chart, first compute the MSE. The square root of MSE is used in practice as an estimate of the standard deviation of the distribution of errors.⁴ That is,

$$s = \sqrt{\text{MSE}} \quad (3-18)$$

Control charts are based on the assumption that when errors are random, they will be distributed according to a normal distribution around a mean of zero. Recall that for a normal distribution, approximately 95.5 percent of the values (errors in this case) can be expected to fall within limits of $0 \pm 2s$ (i.e., 0 ± 2 standard deviations), and approximately 99.7 percent of the values can be expected to fall within $\pm 3s$ of zero. With that in mind, the following formulas can be used to obtain the upper control limit (UCL) and the lower control limit (LCL):

$$\text{UCL: } 0 + z\sqrt{\text{MSE}}$$

$$\text{LCL: } 0 - z\sqrt{\text{MSE}}$$

where

z = Number of standard deviations from the mean

Combining these two formulas, we obtain the following expression for the control limits:

$$\text{Control limits: } 0 \pm z\sqrt{\text{MSE}} \quad (3-19)$$

EXAMPLE 10

Computing Control Limits for Errors

Compute $2s$ control limits for forecast errors when the MSE is 9.0.

SOLUTION

$$s = \sqrt{\text{MSE}} = 3.0$$

$$\text{UCL} = 0 + 2(3.0) = +6.0$$

$$\text{LCL} = 0 - 2(3.0) = -6.0$$

eXcel

mhhe.com/stevenson14e

⁴The actual value could be computed as $s = \sqrt{\frac{\sum(e - \bar{e})^2}{n - 1}}$.

Another method is the **tracking signal**. It relates the cumulative forecast error to the average absolute error (i.e., MAD). The intent is to detect any **bias** in errors over time (i.e., a tendency for a sequence of errors to be positive or negative). The tracking signal is computed period by period using the following formula:

$$\text{Tracking signal}_t = \frac{\sum(\text{Actual}_t - \text{Forecast}_t)}{\text{MAD}_t} \quad (3-20)$$

Values can be positive or negative. A value of zero would be ideal; limits of ± 4 or ± 5 are often used for a range of acceptable values of the tracking signal. If a value outside the acceptable range occurs, that would be taken as a signal that there is bias in the forecast, and that corrective action is needed.

After an initial value of MAD has been determined, the value of MAD can be updated and smoothed (SMAD) using exponential smoothing:

$$\text{SMAD}_t = \text{MAD}_{t-1} + \alpha(|\text{Actual} - \text{Forecast}|_t - \text{MAD}_{t-1}) \quad (3-21)$$

Tracking signal The ratio of cumulative forecast error to the corresponding value of MAD, used to monitor a forecast.

Bias Persistent tendency for forecasts to be greater or less than the actual values of a time series.

a. Computing a Tracking Signal and b. Computing Control Limits

Monthly attendance at financial planning seminars for the past 24 months, and forecasts and errors for those months, are shown in the following table. Determine if the forecast is working using these approaches:

1. A tracking signal, beginning with month 10, updating MAD with exponential smoothing. Use limits of ± 4 and $\alpha = .2$.
2. A control chart with $2s$ limits. Use data from the first eight months to develop the control chart, and then evaluate the remaining data with the control chart.

Month	A (Attendance)	F (Forecast)	A - F (Error)	lel	Cumulative lel
1	47	43	4	4	4
2	51	44	7	7	11
3	54	50	4	4	15
4	55	51	4	4	19
5	49	54	-5	5	24
6	46	48	-2	2	26
7	38	46	-8	8	34
8	32	44	-12	12	46
9	25	35	-10	10	56
10	24	26	-2	2	58
11	30	25	5	5	
12	35	32	3	3	
13	44	34	10	10	
14	57	50	7	7	
15	60	51	9	9	
16	55	54	1	1	
17	51	55	-4	4	
18	48	51	-3	3	
19	42	50	-8	8	
20	30	43	-13	13	
21	28	38	-10	10	
22	25	27	-2	2	
23	35	27	8	8	
24	38	32	6	6	
			-11		

EXAMPLE 11



SOLUTION

1. The sum of absolute errors through the 10th month is 58. Hence, the initial MAD is $58/10 = 5.8$. The subsequent MADs are updated using the formula $MAD_{\text{new}} = MAD_{\text{old}} + \alpha(|e| - MAD_{\text{old}})$. The results are shown in the following table. The tracking signal for any month is

$$\frac{\text{Cumulative error at that month}}{\text{Updated MAD at that month}}$$

t (Month)	$ e $	$MAD_t = MAD_{t-1} + .2(e - MAD_{t-1})$	Cumulative Error	Tracking Signal = Cumulative Error \div MAD $_t$
10			-20	$-20/5.800 = -3.45$
11	5	$5.640 = 5.8 + .2(5 - 5.8)$	-15	$-15/5.640 = -2.66$
12	3	$5.112 = 5.640 + .2(3 - 5.64)$	-12	$-12/5.112 = -2.35$
13	10	$6.090 = 5.112 + .2(10 - 5.112)$	-2	$-2/6.090 = -0.33$
14	7	$6.272 = 6.090 + .2(7 - 6.090)$	5	$5/6.272 = 0.80$
15	9	$6.818 = 6.272 + .2(9 - 6.272)$	14	$14/6.818 = 2.05$
16	1	$5.654 = 6.818 + .2(1 - 6.818)$	15	$15/5.654 = 2.65$
17	4	$5.323 = 5.654 + .2(4 - 5.654)$	11	$11/5.323 = 2.07$
18	3	$4.858 = 5.323 + .2(3 - 5.323)$	8	$8/4.858 = 1.65$
19	8	$5.486 = 4.858 + .2(8 - 4.858)$	0	$0/5.486 = 0.00$
20	13	$6.989 = 5.486 + .2(13 - 5.486)$	-13	$-13/6.989 = -1.86$
21	10	$7.591 = 6.989 + .2(10 - 6.989)$	-23	$-23/7.591 = -3.03$
22	2	$6.473 = 7.591 + .2(2 - 7.591)$	-25	$-25/6.473 = -3.86$
23	8	$6.778 = 6.473 + .2(8 - 6.473)$	-17	$-17/6.778 = -2.51$
24	6	$6.622 = 6.778 + .2(6 - 6.778)$	-11	$-11/6.622 = -1.66$

Because the tracking signal is within ± 4 every month, there is no evidence of a problem.

2. a. Make sure that the average error is approximately zero, because a large average would suggest a biased forecast.

$$\text{Average error} = \frac{\sum \text{errors}}{n} = \frac{-11}{24} = -0.46$$

- b. Compute the standard deviation:

$$s = \sqrt{\text{MSE}} = \sqrt{\frac{\sum e^2}{n-1}}$$

$$= \sqrt{\frac{4^2 + 7^2 + 4^2 + 4^2 + (-5)^2 + (-2)^2 + (-8)^2 + (-12)^2}{8-1}} = 6.91$$

- c. Determine $2s$ control limits:

$$0 \pm 2s = 0 \pm 2(6.91) = -13.82 \text{ to } +13.82$$

- d. (1) Check that all errors are within the limits. (They are.)

- (2) Plot the data (see the following graph), and check for nonrandom patterns. Note the strings of positive and negative errors. This suggests nonrandomness (and that an improved forecast is possible). The tracking signal did not reveal this.

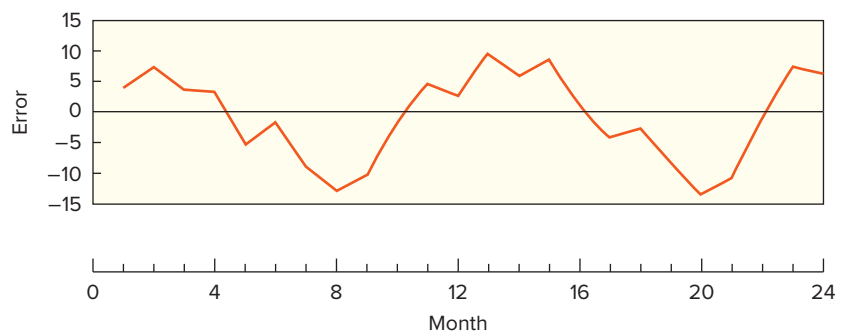

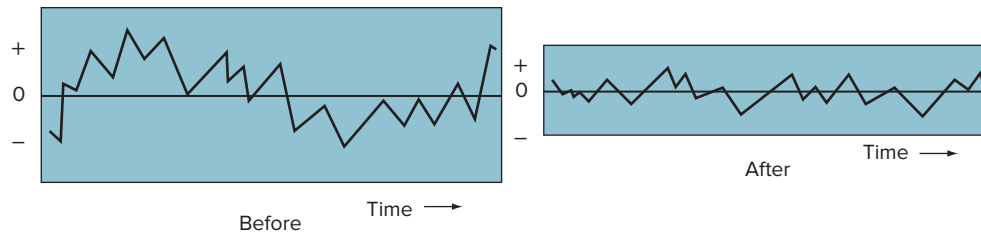
**FIGURE 3.13**

Removal of a pattern usually results in less variability, and, hence, narrower control limits

A plot helps you to visualize the process and enables you to check for possible patterns (i.e., nonrandomness) within the limits that suggest an improved forecast is possible.⁵

Like the tracking signal, a control chart focuses attention on deviations that lie outside pre-determined limits. With either approach, however, it is desirable to check for possible patterns in the errors, even if all errors are within the limits.

If nonrandomness is found, corrective action is needed. That will result in less variability in forecast errors, and, thus, in narrower control limits. (Revised control limits must be computed using the resulting forecast errors.) Figure 3.13 illustrates the impact on control limits due to decreased error variability.

Comment The control chart approach is generally superior to the tracking signal approach. A major weakness of the tracking signal approach is its use of cumulative errors: Individual errors can be obscured so that large positive and negative values cancel each other. Conversely, with control charts, every error is judged individually. Thus, it can be misleading to rely on a tracking signal approach to monitor errors. In fact, the historical roots of the tracking signal approach date from before the first use of computers in business. At that time, it was much more difficult to compute standard deviations than to compute average deviations; for that reason, the concept of a tracking signal was developed. Now computers and calculators can easily provide standard deviations. Nonetheless, the use of tracking signals has persisted, probably because users are unaware of the superiority of the control chart approach.

3.12 CHOOSING A FORECASTING TECHNIQUE

Many different kinds of forecasting techniques are available, and no single technique works best in every situation. When selecting a technique, the manager or analyst must take a number of factors into consideration.

The two most important factors are *cost* and *accuracy*. How much money is budgeted for generating the forecast? What are the possible costs of errors, and what are the benefits that might accrue from an accurate forecast? Generally speaking, the higher the accuracy, the higher the cost, so it is important to weigh cost–accuracy trade-offs carefully. The best forecast is not necessarily the most accurate or the least costly; rather, it is some combination of accuracy and cost deemed best by management.

Other factors to consider in selecting a forecasting technique include the availability of historical data; the availability of computer software; and the time needed to gather and analyze data and to prepare the forecast. The forecast horizon is important because some techniques are more suited to long-range forecasts while others work best for the short range. For example, moving averages and exponential smoothing are essentially short-range techniques, because they produce forecasts for the *next* period. Trend equations can be used to project over much longer time periods. When using time-series data, *plotting the data* can be very helpful in choosing an appropriate method. Several of the qualitative techniques are well-suited to long-range forecasts because they do not require historical data. The Delphi method and executive opinion methods are often used for long-range planning. New products and services lack historical data, so forecasts for them must be based on subjective estimates. In many cases,

LO3.16 Describe the key factors and trade-offs to consider when choosing a forecasting technique.

⁵The theory and application of control charts and the various methods for detecting patterns in the data are covered in more detail in Chapter 10, on quality control.

TABLE 3.4 A guide to selecting an appropriate forecasting method

Forecasting Method	Amount of Historical Data	Data Pattern	Forecast Horizon	Preparation Time	Personnel Background
Moving average	2 to 30 observations	Variation around an average	Short	Short	Little sophistication
Simple exponential smoothing	5 to 10 observations	Variation around an average	Short	Short	Little sophistication
Trend-adjusted exponential smoothing	10 to 15 observations	Trend	Short to medium	Short	Moderate sophistication
Trend models	10 to 20; for seasonality at least 5 per season	Trend	Short to medium	Short	Moderate sophistication
Seasonal	Enough to see 2 peaks and troughs	Handles cyclical and seasonal patterns	Short to medium	Short to moderate	Little sophistication
Causal regression models	10 observations per independent variable	Can handle complex patterns	Short, medium, or long	Long development time, short time for implementation	Considerable sophistication

Source: Adapted from J. Holton Wilson and Deborah Allison-Koerber, "Combining Subjective and Objective Forecasts Improves Results," *Journal of Business Forecasting*, Fall 1992, p. 4. Institute of Business Forecasting.

TABLE 3.5

Forecast factors, by range of forecast

Factor	Short Range	Intermediate Range	Long Range
1. Frequency	Often	Occasional	Infrequent
2. Level of aggregation	Item	Product family	Total output Type of product/service
3. Type of model	Smoothing Projection Regression	Projection Seasonal Regression	Managerial judgment
4. Degree of management involvement	Low	Moderate	High
5. Cost per forecast	Low	Moderate	High

experience with similar items is relevant. Table 3.4 provides a guide for selecting a forecasting method. Table 3.5 provides additional perspectives on forecasts in terms of the time horizon.

In some instances, a manager might use more than one forecasting technique to obtain independent forecasts. If the different techniques produced approximately the same predictions, that would give increased confidence in the results; disagreement among the forecasts would indicate that additional analysis may be needed. Another possibility is combining the results of two techniques. Still another possibility is to use several techniques on recent data and then use the one with the least error to make the actual forecast, but keep the others, and then use the one with the least error to make the next forecast, and so on. Then, if one technique consistently performs better than the others, that technique would emerge as the favorite.

3.13 USING FORECAST INFORMATION

A manager can take a *reactive* or a *proactive* approach to a forecast. A reactive approach views forecasts as probable future demand, and a manager reacts to meet that demand (e.g., adjusts production rates, inventories, the workforce). Conversely, a proactive approach seeks to actively influence demand (e.g., by means of advertising, pricing, or product/service changes).

Generally speaking, a proactive approach requires either an explanatory model (e.g., regression) or a subjective assessment of the influence on demand. A manager might make two forecasts—one to predict what will happen under the status quo and a second one based on a “what if clear” approach, if the results of the status quo forecast are unacceptable.

3.14 COMPUTER SOFTWARE IN FORECASTING

Computers play an important role in preparing forecasts based on quantitative data. Their use allows managers to develop and revise forecasts quickly, and without the burden of manual computations. There is a wide range of software packages available for forecasting. The Excel templates on the text website are an example of a spreadsheet approach. There are templates for moving averages, exponential smoothing, linear trend equation, trend-adjusted exponential smoothing, and simple linear regression. Some templates are illustrated in the Solved Problems section at the end of the chapter.



3.15 OPERATIONS STRATEGY

Forecasts are the basis for many decisions and an essential input for matching supply and demand. Clearly, the more accurate an organization's forecasts, the better prepared it will be to take advantage of future opportunities and reduce potential risks. A worthwhile strategy can be to work to improve short-term forecasts. Better short-term forecasts will not only enhance profits through lower inventory levels, fewer shortages, and improved customer service, they also will enhance forecasting *credibility* throughout the organization: If short-term forecasts are inaccurate, why should other areas of the organization put faith in long-term forecasts? Also, the sense of confidence that accurate short-term forecasts would generate would allow allocating more resources to strategic and medium- to longer-term planning and less on short-term, tactical activities.

Maintaining accurate, up-to-date information on prices, demand, and other variables can have a significant impact on forecast accuracy. An organization also can do other things to improve forecasts. These do not involve searching for improved techniques but relate to the inverse relation of accuracy to the forecast horizon: Forecasts that cover shorter time frames tend to be more accurate than longer-term forecasts. Recognizing this, management might choose to devote efforts to *shortening the time horizon that forecasts must cover*. Essentially, this means shortening the *lead time* needed to respond to a forecast. This might involve building *flexibility* into operations to permit rapid response to changing demands for products and services, or to changing volumes in quantities demanded; shortening the lead time required to obtain supplies, equipment, and raw materials, or the time needed to train or retrain employees; or shortening the time needed to *develop* new products and services.

Lean systems are demand driven; goods are produced to fulfill orders rather than to hold in inventory until demand arises. Consequently, they are far less dependent on short-term forecasts than more traditional systems.

In certain situations, forecasting can be very difficult when orders have to be placed far in advance. This is the case, for example, when demand is sensitive to weather conditions, such as the arrival of spring, and there is a narrow window for demand. Orders for products or services that relate to this (e.g., garden materials, advertising space) often have to be placed many months in advance—far beyond the ability of forecasters to accurately predict weather conditions and, hence, the timing of demand. In such cases, there may be pressures from salespeople who want low quotas and from financial people who don't want to have to deal with the cost of excess inventory to have conservative forecasts. Conversely, operations people may want more optimistic forecasts to reduce the risk of being blamed for possible shortages.

Sharing forecasts or demand data throughout the supply chain can improve forecast quality in the supply chain, resulting in lower costs and shorter lead times. For example, both Hewlett-Packard and IBM require resellers to include such information in their contracts.

The following reading provides additional insights on forecasting and supply chains.



BY RAM REDDY

Disregarding Demand Forecasting Technologies during Tough Economic Times Can Be a Costly Mistake

Caught up in the general disillusionment with IT in a downturn has been demand forecasting (DF) technologies. Many companies blame DF technologies for supply chain problems such as excess inventory. Pinning the blame on and discontinuing DF technologies is the equivalent of throwing out the baby with the bathwater. The DF misunderstanding stems from the fact that, despite sophisticated mathematical models and underlying technologies, the output from these systems is, at best, an educated guess about the future.

A forecast from these systems is only as good as the assumptions and data used to build the forecast. Even the best forecast fails when an unexpected event—such as a recession—clobbers the underlying assumptions. However, this doesn't imply that DF technologies aren't delivering the goods. But, unfortunately, many DF and supply chain technology implementations have recently fallen victim to this mindset. DF is part science and part art (or intuition)—having the potential to significantly impact a company's bottom line. In this column, you'll find an overview of how DF is supposed to work, which you can compare with how most companies actually practice it. I'll conclude with suggestions on how to avoid common mistakes when implementing and using this particular class of technologies.

The Need for DF Systems

DF is crucial to minimizing working capital and associated expenses and extracting maximum value from a company's capital investments in property, plant, and equipment (PPE). It takes a manufacturing company a lot of lead time to assemble and stage the raw materials and components to manufacture a given number of products per day. The manufacturing company, in turn, generates its sales forecast numbers using data from a variety of sources such as distribution channels, factory outlets, value-added resellers, historical sales data, and general macroeconomic data. Manufacturing companies can't operate without a demand forecast because they won't know the quantities of finished goods to produce. The manufacturing company wants to make sure all or much of its finished product moves off the store shelves or dealer lots as quickly as possible. Unsold products represent millions of dollars tied up in inventory.

The flip side of this equation is the millions of dollars invested in PPE to manufacture the finished products. The company and its supporting supply chain must utilize as close to 100 percent of its PPE investments. Some manufacturing plants make products in lots of 100 or 1,000. Generally, it's cost prohibitive to have production runs of one unit. So how do you extract maximum value from your investments and avoid having money tied up in unsold inventory?

DF and supply chain management (SCM) technologies try to solve this problem by generating a production plan to meet forecasted demand and extract maximum value from PPE, while reducing the amount of capital tied up in inventory. Usually, the demand forecast is pretty close to the actual outcomes, but there are times when demand forecasts don't match the outcomes. In addition to unforeseen economic events, a new product introduction may be a stellar success or an abysmal failure. In the case of a phenomenal success, the manufacturing plant may not be able to meet demand for its product.

Consider the case of the Chrysler PT Cruiser. It succeeded way beyond the demand forecast's projections. Should it have started with manufacturing capacity to fulfill the runaway demand? Absolutely not. Given the additional millions of dollars of investment in PPE necessary to add that capacity, it would've backfired if the PT Cruiser had been a flop. The value provided by DF and supporting SCM technologies in this instance was the ability to add capacity to meet the amended forecast based on actual events. Demand forecasts can and do frequently miss their targets. The point to underscore here is that the underlying DF and supporting SCM technologies are critical to a company's ability to react and respond in a coordinated manner when market conditions change.

The manufacturing company and its supply chain are able to benefit from sharing information about the changed market conditions and responding to them in a coordinated manner. Despite best practices embedded in DF and SCM technologies to support this manner of collaboration, it plays out differently in the real world.

How It Works in Real Life—Worst Practices

A company prepares its forecast by taking into account data about past sales, feedback from distribution channels, qualitative assessments from field sales managers, and macroeconomic data. DF and SCM technologies take these inputs and add existing capacities within the company and across the supply chain to generate a production plan for optimum financial performance.

There's been incredible pressure on executives of publicly traded companies to keep up stock prices. This pressure, among other reasons, may cause manufacturing company executives to make bold projections to external financial analysts (or Wall Street) about future sales without using the demand forecast generated from the bottom up. When the company realizes this disparity between the initial projection and the forecast, the forecast is changed to reflect the projections made by the company's officers, negating its accuracy.

The company arbitrarily sets sales targets for various regions to meet Wall Street numbers that are totally out of sync with input provided by the regional sales managers for the DF process. Even though the regional sales managers' input may have a qualitative element (art), they tend to be more accurate, given their proximity to the customers in the region. Unfortunately, the arbitrary sales targets make their way back to the supply chain, and the result

is often excessive inventory buildup starting at the distribution channels to the upstream suppliers.

Seeing the inventory pile up, the manufacturing company may decide to shut down a production line. This action affects upstream suppliers who had procured raw materials and components to meet the executive-mandated production numbers, which may cause them to treat any future forecasted numbers with suspicion. Most cost efficiencies that could be obtained through planned procurement of raw materials and components go out the window. It's very likely that the companies try to blame DF and SCM technologies for failing to provide a responsive and efficient supply chain, even though the fault may lie in the company's misuse of the technologies and not the technologies themselves.

Guarding against the Extremes

Earlier in this column, I said that DF is part art or intuition and part science. The art/intuition part comes in when subject-matter experts (SMEs) make educated estimates about future sales. These SMEs could range from distribution outlet owners to sales and marketing gurus and economists. Their intuition is typically combined with data (such as historical sales figures) to generate the forecast for the next quarter or year. During a recession, the SMEs tend to get overly pessimistic. The demand forecasts generated from this mindset lead to inventory shortages when the economy recovers. Similarly, during an economic expansion, the SMEs tend to have an overly rosy picture of the future. This optimism leads to inventory gluts when the economy starts to slow down. In both instances, blaming and invalidating DF and SCM technologies is counterproductive in the long run.

It's very rare that a demand forecast and the actual outcome match 100 percent. If it's close enough to avoid lost sales or create an excess inventory situation, it's deemed a success. DF and supporting SCM technologies are supposed to form a closed loop, with actual sales at the cash register providing a feedback mechanism. This feedback is especially essential during economic upturns or downturns. It provides the necessary information to a company and its supply chain to react in a coordinated and efficient manner.

Don't let the current disillusionment with DF and SCM technologies impede the decision-making process within your company. The intelligent enterprise needs these technologies to effectively utilize its capital resources and efficiently produce to meet its sales forecasts.

Ram Reddy is the author of *Supply Chains to Virtual Integration* (McGraw-Hill, 2001). He is the president of Tactica Consulting Group, a technology and business strategy consulting company.

Questions

1. What is DF and why is it important?
2. Why might a company executive make bold predictions about future demand to Wall Street analysts?
3. How might an executive's comments to Wall Street analysts affect demand forecasts, and what are the consequences of doing so?

Source: Ram Reddy, "Gazing at the Crystal Ball," *Intelligent Enterprise*, June 13, 2002. Copyright © 2002 Penton Media, Inc. Used with permission.

Forecasts are vital inputs for the design and the operation of the productive systems because they help managers anticipate the future.

Forecasting techniques can be classified as qualitative or quantitative. Qualitative techniques rely on judgment, experience, and expertise to formulate forecasts; quantitative techniques rely on the use of historical data or associations among variables to develop forecasts. Some of the techniques are simple, and others are complex. Some work better than others, but no technique works all the time. Moreover, all forecasts include a certain degree of inaccuracy, and allowance should be made for this. The techniques generally assume that the same underlying causal system that existed in the past will continue to exist in the future.

The qualitative techniques described in this chapter include consumer surveys, salesforce estimates, executive opinions, and manager and staff opinions. Two major quantitative approaches are described: analysis of time-series data and associative techniques. The time-series techniques rely strictly on the examination of historical data; predictions are made by projecting past movements of a variable into the future without considering specific factors that might influence the variable. Associative techniques attempt to explicitly identify influencing factors and to incorporate that information into equations that can be used for predictive purposes.

All forecasts tend to be inaccurate; therefore, it is important to provide a measure of accuracy. It is possible to compute several measures of forecast accuracy that help managers to evaluate the performance of a given technique and to choose among alternative forecasting techniques. Control of forecasts involves deciding whether a forecast is performing adequately, typically using a control chart.

SUMMARY

When selecting a forecasting technique, a manager must choose a technique that will serve the intended purpose at an acceptable level of cost and accuracy.

The various forecasting techniques are summarized in Table 3.6. Table 3.7 lists the formulas used in the forecasting techniques and in the methods of measuring their accuracy. Note that the Excel templates on the text website that accompanies this book are especially useful for tedious calculations.

TABLE 3.6 Forecasting approaches

Approaches	Brief Description
Judgment/opinion:	
Consumer surveys	Questioning consumers on future plans
Direct-contact composites	Joint estimates obtained from salespeople or customer service people
Executive opinion	Finance, marketing, and manufacturing managers join to prepare forecast
Delphi technique	Series of questionnaires answered anonymously by knowledgeable people; successive questionnaires are based on information obtained from previous surveys
Outside opinion	Consultants or other outside experts prepare the forecast
Statistical:	
Time series:	
Naive	Next value in a series will equal the previous value in a comparable period
Moving averages	Forecast is based on an average of recent values
Exponential smoothing	Sophisticated form of weighted moving average
Associative models:	
Simple regression	Values of one variable are used to predict values of a dependent variable
Multiple regression	Two or more variables are used to predict values of a dependent variable

TABLE 3.7
Summary of formulas

Technique	Formula	Definitions
MAD	$MAD = \frac{\sum^n e }{n}$	MAD = Mean absolute deviation e = Error, A - F n = Number of errors
MSE	$MSE = \frac{\sum^n e^2}{n - 1}$	MSE = Mean square error n = Number of errors
MAPE	$MAPE = \frac{\sum^n \left[\frac{ e_t }{\text{Actual}_t} \times 100 \right]}{n}$	MAPE = Mean absolute percent error n = Number of errors
Moving average forecast	$F_t = \frac{\sum_{i=1}^n A_{t-i}}{n}$	A = Demand in period t - i n = Number of periods
Weighted average	$F_t = w_{t-n}A_{t-n} + w_{t-n+1}A_{t-n+1} + \dots + w_{t-2}A_{t-2} + w_{t-1}A_{t-1}$	w _t = Weight for the period t A _t = Actual value in period t
Exponential smoothing forecast	$F_t = F_{t-1} + \alpha(A_{t-1} - F_{t-1})$	α = Smoothing factor

Technique	Formula	Definitions
Linear trend forecast	$F_t = a + b_t$ where $b = \frac{n \sum ty - \sum t \sum y}{n \sum t^2 - (\sum t)^2}$ $a = \frac{\sum y - b \sum t}{n} \text{ or } \bar{y} - b\bar{t}$	$a = y$ intercept $b =$ Slope
Trend-adjusted forecast	$\text{TAF}_{t+1} = S_t + T_t$ where $S_t = \text{TAF}_t + \alpha(A_t - \text{TAF}_t)$ $T_t = T_{t-1} + \beta(\text{TAF}_t - \text{TAF}_{t-1} - T_{t-1})$	$t =$ Current period $\text{TAF}_{t+1} =$ Trend-adjusted forecast for next period $S =$ Previous forecast plus smoothed error $T =$ Trend component
Linear regression forecast	$Y_c = a + bx$ where $b = \frac{n(\sum xy) - (\sum x)(\sum y)}{n(\sum x^2) - (\sum x)^2}$ $a = \frac{\sum y - b \sum x}{n} \text{ or } \bar{y} - b\bar{x}$	$y_c =$ Predicted (dependent) variable $x =$ Predictor (independent) variable $b =$ Slope of the line $a =$ Value of y_c when $x = 0$
Standard error of estimate	$S_e = \sqrt{\frac{\sum (y - y_d)^2}{n - 2}}$	$S_e =$ Standard error of estimate $y =$ y value of each data point $n =$ Number of data points
Tracking signal	$\text{TS}_t = \frac{\sum e}{\text{MAD}_t}$	
Control limits	$\text{UCL} = 0 + z\sqrt{\text{MSE}}$ $\text{LCL} = 0 - z\sqrt{\text{MSE}}$	$\sqrt{\text{MSE}} =$ standard deviation $z =$ Number of standard deviations; 2 and 3 are typical values

Microsoft

1. Demand forecasts are essential inputs for many business decisions. They help managers decide how much supply or capacity will be needed to match expected demand, both within the organization and in the supply chain.
2. Because of random variations in demand, it is likely that the forecast will not be perfect, so managers need to be prepared to deal with forecast errors.
3. Other, nonrandom factors might also be present, so it is necessary to monitor forecast errors to check for nonrandom patterns in forecast errors.
4. It is important to choose a forecasting technique that is cost-effective and one that minimizes forecast error.

KEY POINTS

- | | | |
|-----------------------------|---|--|
| associative model, 80 | judgmental forecasts, 80 | regression, 98 |
| bias, 109 | least squares line, 99 | seasonality, 82 |
| centered moving average, 96 | linear trend equation, 89 | seasonal relative, 94 |
| control chart, 107 | mean absolute deviation (MAD), 106 | seasonal variations, 93 |
| correlation, 102 | mean absolute percent error (MAPE), 106 | standard error of estimate, 100 |
| cycle, 82 | mean squared error (MSE), 106 | time series, 82 |
| Delphi method, 81 | moving average, 84 | time-series forecasts, 80 |
| error, 105 | naive forecast, 82 | tracking signal, 109 |
| exponential smoothing, 87 | predictor variables, 98 | trend, 82 |
| focus forecasting, 88 | random variations, 82 | trend-adjusted exponential smoothing, 92 |
| forecast, 76 | | weighted average, 86 |
| irregular variation, 82 | | |

KEY TERMS

SOLVED PROBLEMS

Problem 1 Forecasts based on averages. Given the following data:

Period	Number of Complaints
1	60
2	65
3	55
4	58
5	64

Prepare a forecast for period 6 using each of these approaches:

- The appropriate naive approach.
- A three-period moving average.
- A weighted average using weights of .50 (most recent), .30, and .20.
- Exponential smoothing with a smoothing constant of .40.

Solution Step by step

- Plot the data to see if there is a pattern. Here, we have only variations around an average (i.e., no trend or cycles). Therefore, the most recent value of the series becomes the next forecast: 64.
- Use the latest values. $MA_3 = \frac{55 + 58 + 64}{3} = 59$
- $F = .20(55) + .30(58) + .50(64) = 60.4$
- Start with period 2. Use the data in period 1 as the forecast for period 2, and then use exponential smoothing for successive forecasts.

Period	Number of Complaints	Forecast	Calculations
1	60		
2	65	60	[The previous value of the series is used as the starting forecast.]
3	55	62	$60 + .40(65 - 60) = 62$
4	58	59.2	$62 + .40(55 - 62) = 59.2$
5	64	58.72	$59.2 + .40(58 - 59.2) = 58.72$
6		60.83	$58.72 + .40(64 - 58.72) = 60.83$



You also can obtain the forecasts and a plot using an Excel template, as shown:

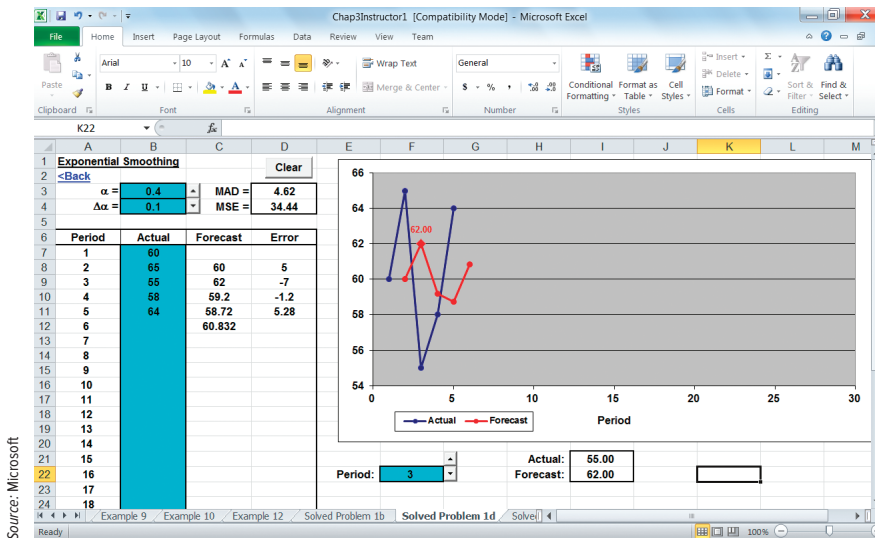

Using seasonal relatives. Apple's Citrus Fruit Farm ships boxed fruit to anywhere in the world. Using the following information, a manager wants to forecast shipments for the first four months of next year.

Problem 2



mhhe.com/stevenson14e

Month	Seasonal Relative	Month	Seasonal Relative
Jan.	1.2	Jul.	0.8
Feb.	1.3	Aug.	0.6
Mar.	1.3	Sep.	0.7
Apr.	1.1	Oct.	1.0
May.	0.8	Nov.	1.1
Jun.	0.7	Dec.	1.4

The monthly forecast equation being used is:

$$F_t = 402 + 3t$$

where

$$t_0 = \text{January of last year}$$

$$F_t = \text{Forecast of shipments for month } t$$

- a. Determine trend amounts for the first four months of next year: January, $t = 24$; February, $t = 25$; etc. Thus,

$$F_{\text{Jan}} = 402 + 3(24) = 474$$

$$F_{\text{Feb}} = 402 + 3(25) = 477$$

$$F_{\text{Mar}} = 402 + 3(26) = 480$$

$$F_{\text{Apr}} = 402 + 3(27) = 483$$

- b. Multiply each monthly trend by the corresponding seasonal relative for that month.

Month	Seasonal Relative	Forecast
Jan.	1.2	$474(1.2) = 568.8$
Feb.	1.3	$477(1.3) = 620.1$
Mar.	1.3	$480(1.3) = 624.0$
Apr.	1.1	$483(1.1) = 531.3$

Linear trend line. Plot the data on a graph, and verify visually that a linear trend line is appropriate. Develop a linear trend equation for the following data. Then, use the equation to predict the next two values of the series.

Period	Demand
1	44
2	52
3	50
4	54
5	55
6	55
7	60
8	56
9	62

Solution

Problem 3

Solution

A plot of the data indicates that a linear trend line is appropriate:

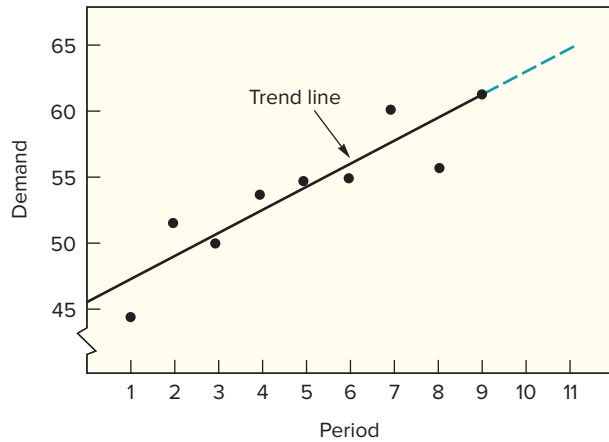

Period, t	t^2	Demand, y	ty
1	1	44	44
2	4	52	104
3	9	50	150
4	16	54	216
5	25	55	275
6	36	55	330
7	49	60	420
8	64	56	448
9	81	62	558
45	285	488	2,545

$\sum t = 45$ and $\sum t^2 = 285$

$$b = \frac{n\sum ty - \sum t\sum y}{n\sum t^2 - (\sum t)^2} = \frac{9(2,545) - 45(488)}{9(285) - 45(45)} = 1.75$$

$$a = \frac{\sum y - b\sum t}{n} = \frac{488 - 1.75(45)}{9} = 45.47$$

Thus, the trend equation is $F_t = 45.47 + 1.75t$. The next two forecasts are:

$$F_{10} = 45.47 + 1.75(10) = 62.97$$

$$F_{11} = 45.47 + 1.75(11) = 64.72$$

You also can use an Excel template to obtain the coefficients and a plot. Simply replace the existing data in the template with your data.

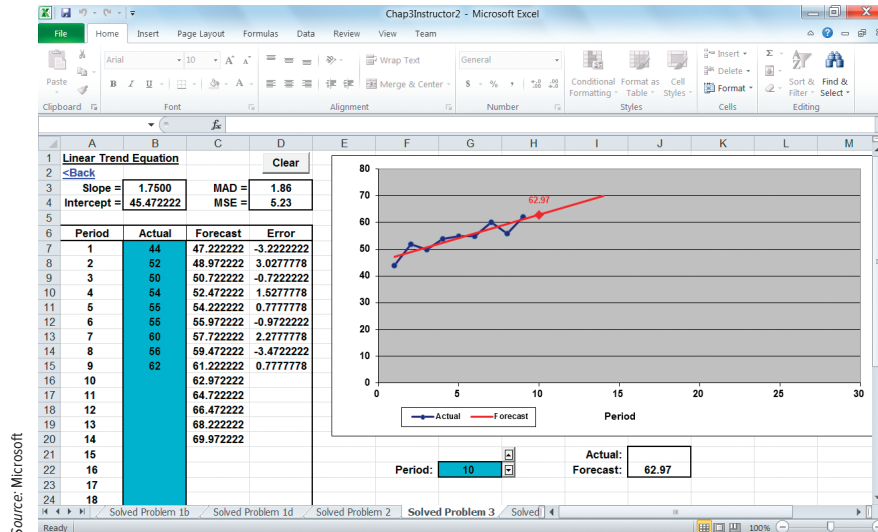

Source: Microsoft

Seasonal relatives. Obtain estimates of quarter relatives for these data using the centered moving average method:

	YEAR												
	1				2				3				4
Quarter:	1	2	3	4	1	2	3	4	1	2	3	4	1
Demand:	14	18	35	46	28	36	60	71	45	54	84	88	58

Note that each season has an *even* number of data points. When an even-numbered moving average is used (in this case, a four-period moving average), the “centered value” will not correspond to an actual data point; the center of 4 is *between* the second and third data points. To correct for this, a *second* set of moving averages must be computed using the MA_4 values. The MA_2 values are centered between the MA_4 and “line up” with actual data points. For example, the first MA_4 value is 28.25. It is centered between 18 and 35 (i.e., between quarter 2 and quarter 3). When the average of the first two MA_4 values is taken (i.e., MA_2) and centered, it lines up with the 35 and, hence, with quarter 3.

So, whenever an even-numbered moving average is used as a centered moving average (e.g., MA_4 , MA_{12}), a second moving average, a two-period moving average, is used to achieve correspondence with periods. This procedure is not needed when the number of periods in the centered moving average is odd.

Year	Quarter	Demand	MA_4	MA_2	Demand/ MA_2
1	1	14			
	2	18	28.25		
	3	35	31.75	30.00	1.17
	4	46	36.25	34.00	1.35
2	1	28	42.50	39.38	0.71
	2	36	48.75	45.63	0.79
	3	60	53.00	50.88	1.18
	4	71	57.50	55.25	1.29
3	1	45	63.50	60.50	0.74
	2	54	67.75	65.63	0.82
	3	84	71.00	69.38	1.21
	4	88			
4	1	58			

	QUARTER			
	1	2	3	4
	0.71	0.79	1.17	1.35
	<u>0.74</u>	<u>0.82</u>	1.18	<u>1.29</u>
	1.45	1.61	<u>1.21</u>	2.64
			3.56	
Average for the quarter:	0.725	0.805	1.187	1.320

The sum of these relatives is 4.037. Multiplying each by $4.00/4.037$ will standardize the relatives, making their total equal 4.00. The resulting relatives are quarter 1, .718; quarter 2, .798; quarter 3, 1.176; quarter 4, 1.308.

Problem 4

Excel

mhhe.com/stevenson14e

Solution

Problem 5 *Regression line.* A large Midwestern retailer has developed a graph that summarizes the effect of advertising expenditures on sales volume. Using the graph, determine an equation of the form $y = a + bx$ that describes this relationship.

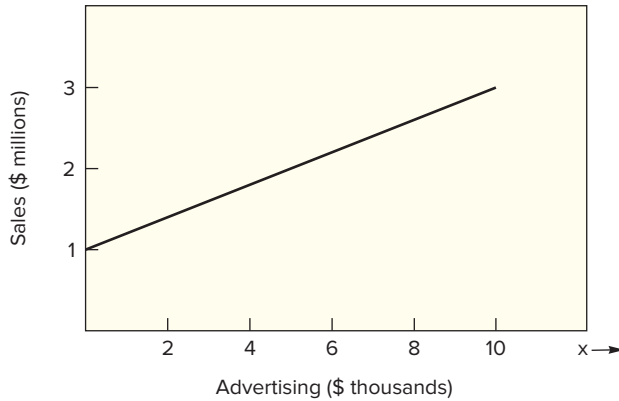

Solution The linear equation has the form $y = a + bx$, where a is the value of y when $x = 0$ (i.e., where the line intersects the y axis) and b is the slope of the line (the amount by which y changes for a one-unit change in x).

Accordingly, $a = 1$ and $b = (3 - 1)/(10 - 0) = .2$, so $y = a + bx$ becomes $y = 1 + .2x$. [Note: $(3 - 1)$ is the change in y , and $(10 - 0)$ is the change in x .]

Problem 6 *Regression analysis.* The owner of a small hardware store has noted a sales pattern for window locks that seems to parallel the number of break-ins reported each week in the newspaper. The data are:

Sales:	46	18	20	22	27	34	14	37	30
Break-ins:	9	3	3	5	4	7	2	6	4

- Plot the data to determine which type of equation, linear or nonlinear, is appropriate.
- Obtain a regression equation for the data.
- Estimate average sales when the number of break-ins is five.

Solution

mhhe.com/stevenson14e

a.

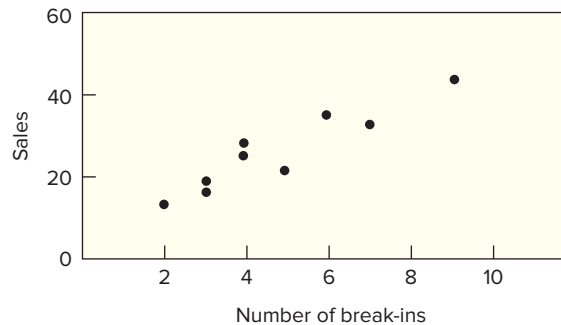

The graph supports a linear relationship.

- You can obtain the regression coefficients using the appropriate Excel template. Simply replace the existing data for x and y with your data. *Note:* Be careful to enter the values for the variable you want to predict as y values. In this problem, the objective is to predict sales, so the sales values are entered in the y column. The equation is $y_c = 7.129 + 4.275x$.

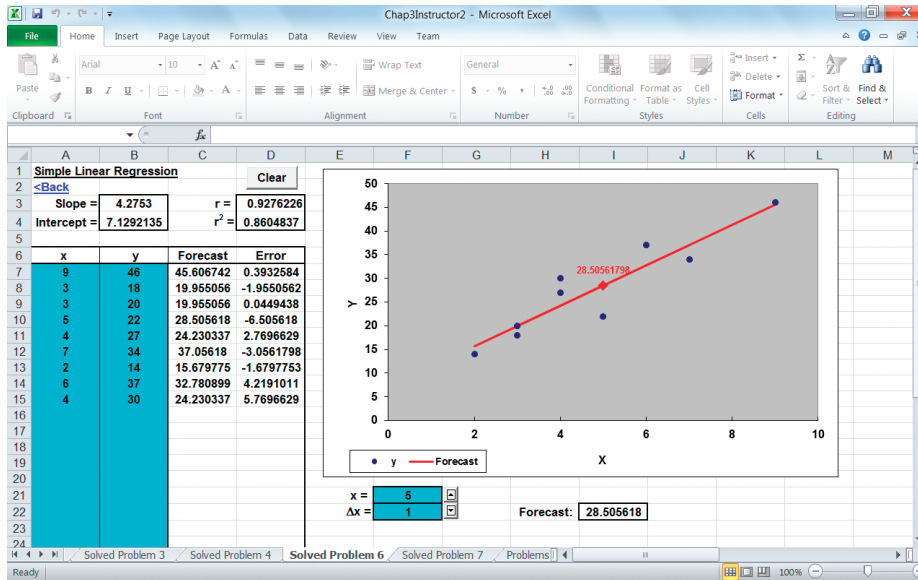

Source: Microsoft

c. For $x = 5$, $y_c = 7.129 + 4.275(5) = 28.50$.

Accuracy of forecasts. The manager of a large manufacturer of industrial pumps must choose between two alternative forecasting techniques. Both techniques have been used to prepare forecasts for a six-month period. Using MAD as a criterion, which technique has the better performance record?

Problem 7
Excel
 mhhe.com/stevenson14e

FORECAST

Month	Demand	Technique 1	Technique 2
1	492	488	495
2	470	484	482
3	485	480	478
4	493	490	488
5	498	497	492
6	492	493	493

Check that each forecast has an average error of approximately zero. (See computations that follow.)

Solution

Month	Demand	Technique 1	e	lel	Technique 2	e	lel
1	492	488	4	4	495	-3	3
2	470	484	-14	14	482	-12	12
3	485	480	5	5	478	7	7
4	493	490	3	3	488	5	5
5	498	497	1	1	492	6	6
6	492	493	-1	1	493	-1	1
			-2	28		+2	34

$$MAD_1 = \frac{\sum |e|}{n} = \frac{28}{6} = 4.67$$

$$MAD_2 = \frac{\sum |e|}{n} = \frac{34}{6} = 5.67$$

Technique 1 is superior in this comparison because its MAD is smaller, although six observations would generally be too few on which to base a realistic comparison.

Problem 8 *Control chart.* Given the demand data that follow, prepare a naive forecast for periods 2 through 10. Then, determine each forecast error, and use those values to obtain $2s$ control limits. If demand in the next two periods turns out to be 125 and 130, can you conclude that the forecasts are in control?

Period:	1	2	3	4	5	6	7	8	9	10
Demand:	118	117	120	119	126	122	117	123	121	124

Solution For a naive forecast, each period's demand becomes the forecast for the next period. Hence, the forecasts and errors are:

Period	Demand	Forecast	Error	Error ²
1	118	—	—	—
2	117	118	-1	1
3	120	117	3	9
4	119	120	-1	1
5	126	119	7	49
6	122	126	-4	16
7	117	122	-5	25
8	123	117	6	36
9	121	123	-2	4
10	124	121	3	9
			+6	150

$$s = \sqrt{\frac{\sum \text{Error}^2}{n-1}} = \sqrt{\frac{150}{9-1}} = 4.33 \quad (n = \text{Number of errors})$$

The control limits are $2(4.33) = \pm 8.66$.

The forecast for period 11 was 124. Demand turned out to be 125, for an error of $125 - 124 = +1$. This is within the limits of ± 8.66 . If the next demand is 130 and the naive forecast is 125 (based on the period 11 demand of 125), the error is $+5$. Again, this is within the limits, so you cannot conclude the forecast is not working properly. With more values—at least five or six—you could plot the errors to see whether you could detect any patterns suggesting the presence of nonrandomness.

DISCUSSION AND REVIEW QUESTIONS

- What are the main advantages that quantitative techniques for forecasting have over qualitative techniques? What limitations do quantitative techniques have?
- What are some of the consequences of poor forecasts? Explain.
- List the specific weaknesses of each of the following approaches to developing a forecast.
 - Consumer surveys
 - Salesforce composite
 - Committee of managers or executives
- Forecasts are generally wrong.
 - Why are forecasts generally wrong?
 - Explain the term “wrong” as it pertains to a good forecast.
- What is the purpose of establishing control limits for forecast errors?
- What factors would you consider in deciding whether to use wide or narrow control limits for forecasts?
- Contrast the use of MAD and MSE in evaluating forecasts.
- What advantages as a forecasting tool does exponential smoothing have over moving averages?
- How does the number of periods in a moving average affect the responsiveness of the forecast?

10. What factors enter into the choice of a value for the smoothing constant in exponential smoothing?
11. How accurate is your local five-day weather forecast? Support your answer with actual data.
12. Explain how using a centered moving average with a length equal to the length of a season eliminates seasonality from a time series.
13. Contrast the terms *sales* and *demand*.
14. Contrast the reactive and proactive approaches to forecasting. Give several examples of types of organizations or situations in which each type is used.
15. Explain how flexibility in production systems relates to the forecast horizon and forecast accuracy.
16. How is forecasting in the context of a supply chain different from forecasting for just a single organization? List possible supply chain benefits and discuss potential difficulties in doing supply chain forecasting.
17. Which type of forecasting approach, qualitative or quantitative, is better?
18. Suppose a software producer is about to release a new version of its popular software. What information do you think it would take into account in forecasting initial sales?
19. Choose the type of forecasting technique (survey, Delphi, averaging, seasonal, naive, trend, or associative) that would be most appropriate for predicting the:
 - a. Demand for Mother's Day greeting cards.
 - b. Popularity of a new television series.
 - c. Demand for vacations on the moon.
 - d. Impact a price increase of 10 percent would have on sales of orange marmalade.
 - e. Demand for toothpaste in a particular supermarket.

1. Explain the trade-off between responsiveness and stability in a forecasting system that uses time-series data.
2. Who needs to be involved in preparing forecasts?
3. How has technology had an impact on forecasting?

1. It has been said that forecasting using exponential smoothing is like driving a car by looking in the rear-view mirror. What are the conditions that would have to exist for driving a car that are analogous to the assumptions made when using exponential smoothing?
2. What capability would an organization have to have to not need forecasts?
3. When a new business is started, or a patent idea needs funding, venture capitalists or investment bankers will want to see a business plan that includes forecast information related to a profit and loss statement. What type of forecasting information do you suppose would be required?
4. Discuss how you would manage a poor forecast.
5. Omar has heard from some of his customers that they will probably cut back on order sizes in the next quarter. The company he works for has been reducing its salesforce due to falling demand, and he worries that he could be next if his sales begin to fall off. Believing that he may be able to convince his customers not to cut back on orders, he turns in an optimistic forecast of his next quarter sales to his manager. What are the pros and cons of doing that?
6. Give three examples of unethical conduct involving forecasting and the ethical principle each violates.

1. A commercial bakery has recorded sales (in dozens) for three products, shown as follows:

Day	Blueberry Muffins	Cinnamon Buns	Cupcakes
1	30	18	45
2	34	17	26
3	32	19	27
4	34	19	23
5	35	22	22

(continued)

TAKING STOCK

CRITICAL THINKING EXERCISES

PROBLEMS

Day	Blueberry Muffins	Cinnamon Buns	Cupcakes
6	30	23	48
7	34	23	29
8	36	25	20
9	29	24	14
10	31	26	18
11	35	27	47
12	31	28	26
13	37	29	27
14	34	31	24
15	33	33	22

- Predict orders for the following day for each of the products using an appropriate naive method.
Hint: Plot each data set.
 - What should the use of *sales* data instead of *demand* imply?
2. National Scan, Inc., sells radio frequency inventory tags. Monthly sales for a seven-month period were as follows:

Month	Sales (000 units)
Feb.	19
Mar.	18
Apr.	15
May	20
Jun.	18
Jul.	22
Aug.	20

- Plot the monthly data on a sheet of graph paper.
 - Forecast September sales volume using each of the following:
 - The naive approach
 - A five-month moving average
 - A weighted average using .60 for August, .30 for July, and .10 for June
 - Exponential smoothing with a smoothing constant equal to .20, assuming a March forecast of 19(000)
 - A linear trend equation
 - Which method seems least appropriate? Why? (*Hint:* Refer to your plot from part a.)
 - What does use of the term *sales* rather than *demand* presume?
3. A dry cleaner uses exponential smoothing to forecast equipment usage at its main plant. August usage was forecasted to be 88 percent of capacity; actual usage was 89.6 percent of capacity. A smoothing constant of .1 is used.
- Prepare a forecast for September.
 - Assuming actual September usage of 92 percent, prepare a forecast for October usage.
4. An electrical contractor's records during the last five weeks indicate the number of job requests:

Week	1	2	3	4	5
Requests	20	22	18	21	22

Predict the number of requests for week 6 using each of these methods:

- Naive
- A four-period moving average
- Exponential smoothing with $\alpha = .30$; use 20 for week 2 forecast

5. A cosmetics manufacturer's marketing department has developed a linear trend equation that can be used to predict annual sales of its popular Hand & Foot Cream.

$$F_t = 80 + 15t$$

where

F_t = Annual sales (000 bottles)

t is in years

- Are annual sales increasing or decreasing? By how much?
 - Predict annual sales for year 6 using the equation.
6. From the following graph, determine the equation of the linear trend line for time-share sales for Glib Marketing, Inc.

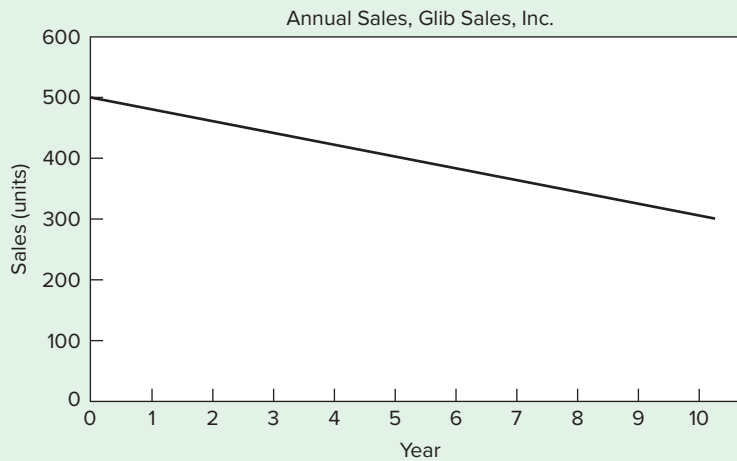

7. Freight car loadings over a 12-year period at a busy port are as follows:

Week	Number	Week	Number	Week	Number
1	220	7	350	13	460
2	245	8	360	14	475
3	280	9	400	15	500
4	275	10	380	16	510
5	300	11	420	17	525
6	310	12	450	18	541

- Determine a linear trend line for expected freight car loadings.
 - Use the trend equation to predict expected loadings for weeks 20 and 21.
 - The manager intends to install new equipment when the volume exceeds 800 loadings per week. Assuming the current trend continues, the loading volume will reach that level in approximately what week?
8. Air travel on Mountain Airlines for the past 18 weeks was:

Week	Passengers
1	405
2	410
3	420
4	415
5	412
6	420
7	424
8	433
9	438

(continued)

Week	Passengers
10	440
11	446
12	451
13	455
14	464
15	466
16	474
17	476
18	482

- a. Explain why an averaging technique would not be appropriate for forecasting.
 - b. Use an appropriate technique to develop a forecast for the expected number of passengers for the next three weeks.
9. a. Obtain the linear trend equation for the following data on new checking accounts at Fair Savings Bank and use it to predict expected new checking accounts for periods 16 through 19.

Period	New Accounts	Period	New Accounts	Period	New Accounts
1	200	6	232	11	281
2	214	7	248	12	275
3	211	8	250	13	280
4	228	9	253	14	288
5	235	10	267	15	310

- b. Use trend-adjusted smoothing with $\alpha = .3$ and $\beta = .2$ to smooth the new account data in part a. What is the forecast for period 16?
10. After plotting demand for four periods, an emergency room manager has concluded that a trend-adjusted exponential smoothing model is appropriate to predict future demand. The initial estimate of trend is based on the net change of 30 for the *three* periods from 1 to 4, for an average of +10 units. Use $\alpha = .5$ and $\beta = .4$, and TAF of 250 for period 5. Obtain forecasts for periods 6 through 10.

Period	Actual	Period	Actual
1	210	6	265
2	224	7	272
3	229	8	285
4	240	9	294
5	255	10	

11. A manager of a store that sells and installs spas wants to prepare a forecast for January, February, and March of next year. Her forecasts are a combination of trend and seasonality. She uses the following equation to estimate the trend component of monthly demand: $F_t = 70 + 5t$, where $t = 0$ in June of last year. Seasonal relatives are 1.10 for January, 1.02 for February, and .95 for March. What demands should she predict?
12. The following equation summarizes the trend portion of quarterly sales of condominiums over a long cycle. Sales also exhibit seasonal variations. Using the information given, prepare a forecast of sales for each quarter of next year (not this year), and the first quarter of the year following that.

$$F_t = 40 - 6.5t + 2t^2$$

where

F_t = Unit Sales

$t = 0$ at the first quarter of last year

Quarter	Relative
1	1.1
2	1.0
3	.6
4	1.3

13. Compute seasonal relatives for this data using the SA method:

Quarter	Year 1	Year 2	Year 3	Year 4
1	2	3	7	4
2	6	10	18	14
3	2	6	8	8
4	5	9	15	11

14. A tourist center is open on weekends (Friday, Saturday, and Sunday). The owner-manager hopes to improve scheduling of part-time employees by determining seasonal relatives for each of these days. Data on recent traffic at the center have been tabulated and are shown in the following table:

	WEEK					
	1	2	3	4	5	6
Friday	149	154	152	150	159	163
Saturday	250	255	260	268	273	276
Sunday	166	162	171	173	176	183

- Develop seasonal relatives for the shop using the centered moving average method.
 - Develop seasonal relatives for the shop using the SA method (see Example 8B).
 - Explain why the results of the two methods correlate the way they do.
15. The manager of a fashionable restaurant open Wednesday through Saturday says that the restaurant does about 35 percent of its business on Friday night, 30 percent on Saturday night, and 20 percent on Thursday night. Which seasonal relatives would describe this situation?
16. Obtain estimates of daily relatives for the number of customers at a restaurant for the evening meal, given the following data.
- Use the centered moving average method. (*Hint:* Use a seven-day moving average.)
 - Use the SA method.

Day	Number Served
1	80
2	75
3	78
4	95
5	130
6	136
7	40
8	82
9	77
10	80
11	94
12	131
13	137
14	42
15	84
16	78
17	83
18	96
19	135
20	140
21	44
22	87
23	82
24	88
25	99
26	144
27	144
28	48

17. A pharmacist has been monitoring sales of a certain over-the-counter pain reliever. Daily sales during the last 15 days were as follows:

Day	1	2	3	4	5	6	7	8	9
Number sold	36	38	42	44	48	49	50	49	52
Day	10	11	12	13	14	15			
Number sold	48	52	55	54	56	57			

- Which method would you suggest using to predict future sales—a linear trend equation or trend-adjusted exponential smoothing? Why?
 - If you learn that on some days the store ran out of the specific pain reliever, would that knowledge cause you any concern? Explain.
 - Assume that the data refer to demand rather than sales. Using trend-adjusted smoothing with an initial forecast of 50 for day 8, an initial trend estimate of 2, and $\alpha = \beta = .3$, develop forecasts for days 9 through 16. What is the MSE for the eight forecasts for which there are actual data?
18. New car sales for a dealer in Cook County, Illinois, for the past year are shown in the following table, along with monthly indexes (seasonal relatives), which are supplied to the dealer by the regional distributor.

Month	Units Sold	Index
Jan.	640	0.80
Feb.	648	0.80
Mar.	630	0.70
Apr.	761	0.94
May.	735	0.89
Jun.	850	1.00
Jul.	765	0.90
Aug.	805	1.15
Sept.	840	1.20
Oct.	828	1.20
Nov.	840	1.25
Dec.	800	1.25

- Plot the data. Does there seem to be a trend?
 - Deseasonalize car sales.
 - Plot the deseasonalized data on the same graph as the original data. Comment on the two graphs.
 - Assuming no proactive approach on the part of management, discuss (no calculations necessary) how you would forecast sales for the first three months of the next year.
 - What action might management consider based on your findings in part *b*?
19. The following table shows a tool and die company's quarterly sales for the current year. What sales would you predict for the first quarter of next year? Quarter relatives are $SR_1 = 1.10$, $SR_2 = .99$, $SR_3 = .90$, and $SR_4 = 1.01$.

Quarter	1	2	3	4
Sales	88	99	108	141.4

20. An analyst must decide between two different forecasting techniques for weekly sales of roller blades: a linear trend equation and the naive approach. The linear trend equation is $= 124 + 2t$, and it was developed using data from periods 1 through 10. Based on data for periods 11 through 20 as shown in the table, which of these two methods has the greater accuracy if MAD and MSE are used?

<i>t</i>	Units Sold
11	147
12	148
13	151
14	145
15	155
16	152
17	155
18	157
19	160
20	165

21. Two different forecasting techniques (F1 and F2) were used to forecast demand for cases of bottled water. Actual demand and the two sets of forecasts are as follows:

Period	Demand	PREDICTED DEMAND	
		F1	F2
1	68	66	66
2	75	68	68
3	70	72	70
4	74	71	72
5	69	72	74
6	72	70	76
7	80	71	78
8	78	74	80

- Compute MAD for each set of forecasts. Given your results, which forecast appears to be more accurate? Explain.
 - Compute the MSE for each set of forecasts. Given your results, which forecast appears to be more accurate?
 - In practice, *either* MAD *or* MSE would be employed to compute forecast errors. What factors might lead a manager to choose one rather than the other?
 - Compute MAPE for each data set. Which forecast appears to be more accurate?
22. Two independent methods of forecasting based on judgment and experience have been prepared each month for the past 10 months. The forecasts and actual sales are as follows:

Month	Sales	Forecast 1	Forecast 2
1	770	771	769
2	789	785	787
3	794	790	792
4	780	784	798
5	768	770	774
6	772	768	770
7	760	761	759
8	775	771	775
9	786	784	788
10	790	788	788

- Compute the MSE and MAD for each forecast. Does either forecast seem superior? Explain.
- Compute MAPE for each forecast.
- Prepare a naive forecast for periods 2 through 11 using the given sales data. Compute each of the following: (1) MSE, (2) MAD, (3) tracking signal at month 10, and (4) $2s$ control limits. How do the naive results compare with the other two forecasts?

23. Long-Life Insurance has developed a linear model that it uses to determine the amount of term life insurance a family of four should have, based on the current age of the head of the household. The equation is:

$$y = 850 - .1x$$

where

y = Insurance needed (\$000)

x = Current age of head of household

- Plot the relationship on a graph.
 - Use the equation to determine the amount of term life insurance to recommend for a family of four if the head of the household is 30 years old.
24. Timely Transport provides local delivery service for a number of downtown and suburban businesses. Delivery charges are based on distance and weight involved for each delivery: 10 cents per pound and 15 cents per mile. Also, there is a \$10 handling fee per parcel.
- Develop an expression that summarizes delivery charges.
 - Determine the delivery charge for transporting a 40-pound parcel 26 miles.
25. The manager of a seafood restaurant was asked to establish a pricing policy on lobster dinners. Experimenting with prices produced the following data:

Average Number Sold per Day, y	Price, x	Average Number Sold per Day, y	Price, x
200	\$6.00	155	\$8.25
190	6.50	156	8.50
188	6.75	148	8.75
180	7.00	140	9.00
170	7.25	133	9.25
162	7.50		
160	8.00		

- Plot the data and a regression line on the same graph.
 - Determine the correlation coefficient and interpret it.
26. The following data were collected during a study of consumer buying patterns:

Observation	x	y
1	15	74
2	25	80
3	40	84
4	32	81
5	51	96
6	47	95
7	30	83
8	18	78
9	14	70
10	15	72
11	22	85
12	24	88
13	33	90

- Plot the data.
 - Obtain a linear regression line for the data.
 - What percentage of the variation is explained by the regression line?
 - Use the equation determined in part *b* to predict the expected value of y for $x = 41$.
27. Lovely Lawns, Inc., intends to use sales of lawn fertilizer to predict lawn mower sales. The store manager estimates a probable six-week lag between fertilizer sales and mower sales. The pertinent data are:

Period	Fertilizer Sales (tons)	Number of Mowers Sold (six-week lag)
1	1.6	10
2	1.3	8
3	1.8	11
4	2.0	12
5	2.2	12
6	1.6	9
7	1.5	8
8	1.3	7
9	1.7	10
10	1.2	6
11	1.9	11
12	1.4	8
13	1.7	10
14	1.6	9

- Determine the correlation between the two variables. Does it appear that a relationship between these variables will yield reasonable predictions? Explain.
 - Obtain a linear regression line for the data.
 - Predict expected lawn mower sales for the first week in August, given fertilizer sales six weeks earlier of 2 tons.
28. The manager of a travel agency has been using a seasonally adjusted forecast to predict demand for packaged tours. The actual and predicted values are as follows:

Period	Demand	Predicted
1	129	124
2	194	200
3	156	150
4	91	94
5	85	80
6	132	140
7	126	128
8	126	124
9	95	100
10	149	150
11	98	94
12	85	80
13	137	140
14	134	128

- Compute MAD for the fifth period, and then update it period by period using exponential smoothing with $\alpha = .3$.
 - Compute a tracking signal for periods 5 through 14 using the initial and updated MADs. If limits of ± 4 are used, what can you conclude?
29. Refer to the data in problem 22.
- Compute a tracking signal for the 10th month for each forecast using the cumulative error for months 1 to 10. Use action limits of ± 4 . Is there bias present? Explain.
 - Compute $2s$ control limits for each forecast.

30. The classified department of a monthly magazine has used a combination of quantitative and qualitative methods to forecast sales of advertising space. Results over a 20-month period are as follows:

Month	Error
1	-8
2	-2
3	4
4	7
5	9
6	5
7	0
8	-3
9	-9
10	-4
11	1
12	6
13	8
14	4
15	1
16	-2
17	-4
18	-8
19	-5
20	-1

- Compute a tracking signal for months 11 through 20. Compute an initial value of MAD for month 11, and then update it for each month using exponential smoothing with $\alpha = .1$. What can you conclude? Assume limits of ± 4 .
 - Using the first half of the data, construct a control chart with $2s$ limits. What can you conclude?
 - Plot the last 10 errors on the control chart. Are the errors random? What is the implication of this?
31. A textbook publishing company has compiled data on total annual sales of its business texts for the preceding nine years:

Year	1	2	3	4	5	6	7	8	9
Sales (000)	40.2	44.5	48.0	52.3	55.8	57.1	62.4	69.0	73.7

- Using an appropriate model, forecast textbook sales for each of the next five years.
- Prepare a control chart for the forecast errors using the original data. Use $2s$ limits.
- Suppose actual sales for the next five years turn out as follows:

Year	10	11	12	13	14
Sales (000)	77.2	82.1	87.8	90.6	98.9

Is the forecast performing adequately? Explain.

32. A manager has just received an evaluation from an analyst on two potential forecasting alternatives. The analyst is indifferent between the two alternatives, saying that they should be equally effective.

Period	1	2	3	4	5	6	7	8	9	10
Data	37	39	37	39	45	49	47	49	51	54
Alt. 1	36	38	40	42	46	46	46	48	52	55
Alt. 2	36	37	38	38	41	52	47	48	52	53

- What would cause the analyst to reach this conclusion?
- What information can you add to enhance the analysis?

33. A manager uses this equation to predict demand for landscaping services: $F_t = 10 + 5t$. Over the past eight periods, demand has been as follows:

Period, t	1	2	3	4	5	6	7	8
Demand	15	21	23	30	32	38	42	47

Is the forecast performing adequately? Explain.

34. A manager uses a trend equation plus quarter relatives to predict demand. Quarter relatives are $SR_1 = .90$, $SR_2 = .95$, $SR_3 = 1.05$, and $SR_4 = 1.10$. The trend equation is: $F_t = 10 + 5t$. Over the past nine quarters, demand has been as follows:

Period, t	1	2	3	4	5	6	7	8	9
Demand	14	20	24	31	31	37	43	48	52

Is the forecast performing adequately? Explain.



M&L Manufacturing makes various components for printers and copiers. In addition to supplying these items to a major manufacturer, the company distributes these and similar items to office supply stores and computer stores as replacement parts for printers and desktop copiers. In all, the company makes about 20 different items. The two markets (the major manufacturer and the replacement market) require somewhat different handling. For example, replacement products must be packaged individually, whereas products are shipped in bulk to the major manufacturer.

The company does not use forecasts for production planning. Instead, the operations manager decides which items to produce and the batch size, based on orders and the amounts in inventory. The products that have the fewest amounts in inventory get the highest priority. Demand is uneven, and the company has experienced being overstocked on some items and out of others. Being understocked has occasionally created tensions with the managers of retail outlets. Another problem is that prices of raw materials have been creeping up, although the operations manager thinks that this might be a temporary condition.

Because of competitive pressures and falling profits, the manager has decided to undertake a number of changes. One change is to introduce more formal forecasting procedures in order to improve production planning and inventory management.

With that in mind, the manager wants to begin forecasting for two products. These products are important for several reasons. First, they account for a disproportionately large share of the company's profits. Second, the manager believes that one of these products will become increasingly important to future growth plans; and third, the other product has experienced periodic out-of-stock instances.

The manager has compiled data on product demand for the two products from order records for the previous 14 weeks. These are shown in the following table.

Week	Product 1	Product 2
1	50	40
2	54	38
3	57	41
4	60	46
5	64	42
6	67	41
7	90*	41
8	76	47
9	79	42
10	82	43
11	85	42
12	87	49
13	92	43
14	96	44

*Unusual order due to flooding of customer's warehouse.

Questions

1. What are some of the potential benefits of a more formalized approach to forecasting?
2. Prepare a weekly forecast for the next four weeks for each product. Briefly explain why you chose the methods you used. (*Hint:* For product 2, a simple approach, possibly some sort of naive/intuitive approach, would be preferable to a technical approach in view of the manager's disdain of more technical methods.)



Highline Financial Services provides three categories of service to its clients. Managing partner Freddie Mack is getting ready to prepare financial and personnel hiring (or layoff) plans for the coming year. He is a bit perplexed by the following printout he obtained, which seems to show oscillating demand for the three categories of services over the past eight quarters:

Year	Quarter	Service		
		A	B	C
1	1	60	95	93
	2	45	85	90
	3	100	92	110
	4	75	65	90

Examine the demand that this company has experienced for the three categories of service it offers over the preceding two years.

Assuming nothing changes in terms of advertising or promotion, and competition doesn't change, predict demand for the services the company offers for the next four quarters. Note that there are not enough data to develop seasonal relatives. Nonetheless, you should be able to make reasonably good, approximate *intuitive* estimates of demand. What general observations can you make regarding demand? Should Freddie have any concerns? Explain.

Year	Quarter	Service		
		A	B	C
2	1	72	85	102
	2	51	75	75
	3	112	85	110
	4	85	50	100

Acar, Yavuc, and Everette S. Gardner, Jr. "Forecasting Method Selection in a Global Supply Chain." *International Journal of Forecasting* 28, no. 4 (October–December 2012), 842–48.

Bonomo, Charles. "Forecasting from the Center of the Supply Chain." *Journal of Business Forecasting Methods and Systems* 22, no. 1 (Spring 2003), p. 3.

Byrne, Robert F. "Forecasting Performance for North American Consumer Products." *Journal of Business Forecasting* 31, no. 3 (Fall 2012), p. 12.

Hanke, John, and Dean Wichern. *Business Forecasting*, 9th ed. Upper Saddle River, NJ: Pearson, 2009.

Hopp, Wallace J., and Mark I. Spearman. *Factory Physics*, 3rd ed. New York: McGraw-Hill, 2008.

Wilson, J. Holton, Barry Keating, and John Galt Solutions. *Business Forecasting with ForecastX*, 6th ed. New York: McGraw-Hill, 2009.

**SELECTED
BIBLIOGRAPHY AND
FURTHER READINGS**

4

Product and Service Design

CHAPTER

LEARNING OBJECTIVES

After completing this chapter, you should be able to:

- LO4.1** Explain the strategic importance of product and service design.
- LO4.2** Describe what product and service design does.
- LO4.3** Name the key questions of product and service design.
- LO4.4** Identify some reasons for design or redesign.
- LO4.5** List some of the main sources of design ideas.
- LO4.6** Discuss the importance of legal, ethical, and sustainability considerations in product and service design.
- LO4.7** Explain the purpose and goal of life-cycle assessment.
- LO4.8** Explain the phrase “the 3 Rs.”
- LO4.9** Briefly describe the phases in product design and development.
- LO4.10** Discuss several key issues in product or service design.
- LO4.11** Discuss the two key issues in service design.
- LO4.12** List the characteristics of well-designed service systems.
- LO4.13** List some guidelines for successful service design.

CHAPTER OUTLINE

- 4.1 Introduction** 140
 - What Does Product and Service Design Do? 140
 - Objectives of Product and Service Design 141
 - Key Questions 141
 - Reasons for Product or Service Design or Redesign 141
- 4.2 Idea Generation** 142
- 4.3 Legal and Ethical Considerations** 144
- 4.4 Human Factors** 145
- 4.5 Cultural Factors** 145
- 4.6 Global Product and Service Design** 146
- 4.7 Environmental Factors: Sustainability** 146
 - Cradle-to-Grave Assessment 146
 - End-of-Life Programs 147
 - The Three Rs: Reduce, Reuse, and Recycle 147
 - Reduce: Value Analysis 147
 - Reuse: Remanufacturing 148
 - Recycle 149
- 4.8 Other Design Considerations** 151
 - Strategies for Product or Service Life Stages 151
 - Product Life Cycle Management 153
 - Degree of Standardization 153
- Designing for Mass Customization 154
- Reliability 156
- Robust Design 157
- Degree of Newness 158
- Quality Function Deployment 158
- The Kano Model 160
- 4.9 Phases in Product Design and Development** 162
- 4.10 Designing for Production** 163
 - Concurrent Engineering 163
 - Computer-Aided Design (CAD) 164
 - Production Requirements 165
 - Component Commonality 165



Mark Lennihan/AP Images

4.11 Service Design 165

- Overview of Service Design 166
- Differences between Service Design and Product Design 166
- Phases in the Service Design Process 167

- Service Blueprinting 168
- Characteristics of Well-Designed Service Systems 168
- Challenges of Service Design 169
- Guidelines for Successful Service Design 169

4.12 Operations Strategy 170

- Operations Tour:** High Acres Landfill 174
- Chapter Supplement:** Reliability 176

The essence of a business organization is the products and services it offers, and every aspect of the organization and its supply chain are structured around those products and services. Organizations that have well-designed products or services are more likely to realize their goals than those with poorly designed products or services. Hence, organizations have a strategic interest in product and service design. Product or service design should be closely tied to an organization's strategy. It is a major factor in cost, quality, time-to-market, customer satisfaction, and competitive advantage. Consequently, marketing, finance, operations, accounting, IT, and HR need to be involved. Demand forecasts and projected costs are important, as is the expected impact on the supply chain. It is significant to note that an important cause of operations failures can be traced to faulty design. Designs that have not been well thought out, or are incorrectly implemented, or instructions for assembly or usage that are wrong or unclear, can be the cause of product and service failures, leading to lawsuits, injuries and deaths, product recalls, and damaged reputations.

LO4.1 Explain the strategic importance of product and service design.

continued



As businesses continue to reduce costs to achieve competitive advantage, design issues are becoming increasingly important aspects of business strategy. Because product and service design touches every part of a business organization, from operations and supply chains to finance, marketing, accounting, and information systems, design decisions have far-reaching implications for the organization and its success in the marketplace. Product and service innovation is becoming a key avenue in pursuing a competitive edge, and sustainability issues are being given increasing importance in business decisions.

Some companies, such as Steelcase, Inc., have adopted “design thinking” to integrate design strategy throughout the company. The idea is to predicate design on insights into user wants and needs—and thus put forth a concept that then becomes the focal point of how the company makes design decisions.

Source: “Product Redesign, Not Offshoring, Holds Cost Advantage for U.S. Manufacturers,” *Supply & Demand Chain Executive*, September 8, 2004. Cygnus Business Media.

The introduction of new products or services, or changes to product or service designs, can have impacts throughout the organization and the entire supply chain. Some processes may change very little, while others may have to change considerably in terms of what they do or how and when they do it. New processes may have to be added, and some current ones may be eliminated. New suppliers and distributors may need to be found and integrated into the system, and some current suppliers and distributors may no longer be an appropriate fit. Moreover, it is necessary to take into account the projected impact on demand, as well as the financial, marketing, and distribution implications. Because of the potential for widespread effects, taking a “big picture” systems approach early and throughout the design or redesign process is imperative to reduce the chance of missing some implications and costs, and to understand the time it will take. Likewise, input from engineering, operations, marketing, finance, accounting, and supply chains is crucial.

In this chapter, you will discover insights into the design process that apply to both product and service design.

LO4.2 Describe what product and service design does.

4.1 INTRODUCTION

This section discusses what product and service designers do, the reasons for design (or redesign), and key questions that management must address.

What Does Product and Service Design Do?

The primary focus of product or service design should be on customer satisfaction. The various activities and responsibilities of product and service design include the following (functional interactions are shown in parentheses):

1. Translate customer wants and needs into product and service requirements (marketing, operations)
2. Refine existing products and services (marketing)
3. Develop new products and/or services (marketing, operations)
4. Formulate quality goals (marketing, operations)
5. Formulate cost targets (accounting, finance, operations)
6. Construct and test prototypes (operations, marketing, engineering)
7. Document specifications
8. Translate product and service specifications into *process* specifications (engineering, operations)

Product and service design involves or affects nearly every functional area of an organization. However, marketing and operations have major involvement.

Objectives of Product and Service Design

Primary consideration: Customer satisfaction.

Secondary considerations: Cost or profit, quality, ability to produce a product or provide a service, ethics/safety, and sustainability.

Key Questions

From a buyer's standpoint, most purchasing decisions entail two fundamental considerations; one is cost and the other is quality or performance. From the organization's standpoint, the key questions are:

1. **Is there demand for it?** What is the potential size of the market, and what is the expected demand profile (will demand be long term or short term, will it grow slowly or quickly)?
2. **Can we do it?** Do we have the necessary knowledge, skills, equipment, capacity, and supply chain capability? For products, this is known as **manufacturability**; for services, this is known as **serviceability**. Also, is outsourcing some or all of the work an option?
3. **What level of quality is appropriate?** What do customers expect? What level of quality do competitors provide for similar items? How would it fit with our current offerings?
4. **Does it make sense from an economic standpoint?** What are the potential liability issues, ethical considerations, sustainability issues, costs, and profits? For nonprofits, is the cost within budget?

LO4.3 Name the key questions of product and service design.

Manufacturability The capability of an organization to produce an item at an acceptable profit.

Serviceability The capability of an organization to provide a service at an acceptable cost or profit.

Reasons for Product and Service Design or Redesign

Product and service design typically has *strategic* implications for the success and prosperity of an organization. Consequently, decisions in this area are some of the most fundamental that managers must make. Product and service design or redesign should be closely tied to an organization's strategy.

Organizations become involved in product and service design or redesign for a variety of reasons. The main forces that initiate design or redesign are market opportunities and threats. The factors that give rise to market opportunities and threats can be one or more *changes*:

- **Economic** (e.g., low demand, excessive warranty claims, the need to reduce costs)
- **Social and demographic** (e.g., aging baby boomers, population shifts)
- **Political, liability, or legal** (e.g., government changes, safety issues, new regulations)
- **Competitive** (e.g., new or changed products or services, new advertising/promotions)
- **Cost or availability** (e.g., of raw materials, components, labor, water, energy)
- **Technological** (e.g., in product components, processes)

While each of these factors may seem obvious, let's reflect a bit on technological changes, which can create a need for product or service design changes in several different ways. An obvious way is new technology that can be used directly in a product or service (e.g., a faster, smaller microprocessor that spawns a new generation of smartphones). Technology also can indirectly affect product and service design: Advances in processing technology may require altering an existing design to make it compatible with the new processing technology. Still another way that technology can impact product design is illustrated by digital recording technology that allows television viewers to skip commercials when they view a recorded program. This means that advertisers (who support a television program) can't get their message to viewers. To overcome this, some advertisers have adopted a strategy of making their products an integral part of a television program, say by having their products prominently displayed and/or mentioned by the actors as a way to call viewers' attention to their products without the need for commercials.

The following reading suggests another potential benefit of product redesign.

LO4.4 Identify some reasons for design or redesign.



DUTCH BOY BRUSHES UP ITS PAINTS

Sherwin-Williams' Dutch Boy Group put a revolutionary spin on paint cans with its innovative square-shaped Twist & Pour™ paint-delivery container for the Dirt Fighter interior latex paint line. The four-piece square container could be the first major change in how house paint is packaged in decades. Lightweight but sturdy, the Twist & Pour “bucket” is packed with so many conveniences, it is next to impossible to mess up a painting project.

Winning Best of Show in an AmeriStar packaging competition sponsored by the Institute of Packaging Professionals, the exclusive, all-plastic paint container stands almost 7½ in. tall and holds 126 oz., a bit less than 1 gal. Rust-resistant and moisture-resistant, the plastic bucket gives users a new way to mix, brush, and store paint.

A hollow handle on one side makes it comfortable to pour and carry. A convenient, snap-in pour spout neatly pours paint into a tray with no dripping but can be removed if desired, to allow a wide brush to be dipped into the 5¾-in.-diameter mouth. Capping the container is a large, twist-off lid that requires no tools to open or close. Molded with two lugs for a snug-finger-tight closing, the threaded cap provides a tight seal to extend the shelf life of unused paint.

While the lid requires no tools to access, the snap-off carry bail is assembled on the container in a “locked-down position” and can be pulled up after purchase for toting or hanging on a ladder. Large, nearly 4½-inch-tall label panels allow glossy front and back labels printed and UV-coated to wrap around the can's rounded corners, for an impressive display.

Jim MacDonald, co-designer of the Twist & Pour and a packaging engineer at Cleveland-based Sherwin-Williams, tells *Packaging Digest* that the space-efficient, square shape is easier to ship and easier to stack in stores. It can also be nested, courtesy of a recess



Jerry Simon

in the bottom that mates with the lid's top ring. “The new design allows for one additional shelf facing on an eight-foot rack or shelf area.”

The labels are applied automatically, quite a feat, considering their complexity, size, and the hollow handle they likely encounter during application. MacDonald admits, “Label application was a challenge. We had to modify the bottle several times to accommodate the labeling machinery available.”

Source: “Dutch Boy Brushes Up Its Paints,” *Packaging Digest*, October 2002. Copyright ©2002 Reed Business Information. Used with permission.

LO4.5 List some of the main sources of design ideas.

4.2 IDEA GENERATION

Ideas for new or redesigned products or services can come from a variety of sources, including customers, the supply chain, competitors, employees, and research. Customer input can come from surveys, focus groups, complaints, and unsolicited suggestions for improvement. Input from suppliers, distributors, and employees can be obtained from interviews, direct or indirect suggestions, and complaints.

One of the strongest motivators for new and improved products or services is competitors' products and services. By studying a competitor's products or services and how the competitor operates (pricing policies, return policies, warranties, location strategies, etc.), an organization can glean many ideas. Beyond that, some companies purchase a competitor's product and then carefully dismantle and inspect it, searching for ways to improve their own product. This is called **reverse engineering**. Automotive companies use this tactic in developing new models. They examine competitors' vehicles, searching for best-in-class components (e.g., best hood release, best dashboard display, best door handle). Sometimes, reverse engineering can enable a company to leapfrog the competition by developing an even better product. However, some forms of reverse engineering are illegal under the *Digital Millennium Copyright Act*.

Reverse engineering Dismantling and inspecting a competitor's product to discover product improvements.



The folks at Vlasic Pickles, a popular brand of all kinds of pickles, decided there was a market for large pickle slices. Pickles, of course, are made from brining cucumbers. The problem was, in order to get large slices, they needed large cucumbers, which didn't exist at the time.



AN NGUYEN/Shutterstock

So Vlasic had to first come up with large cucumbers. Think Botany 101. They crossed a variety of cucumber types, and then had to wait about 10 weeks, the time needed for the cucumber plants to mature, to see what developed. After several attempts, they finally developed a strain of large cucumbers. But those cucumbers didn't taste quite right, so it was back to the drawing board, or, in this case, more crossing of different cucumber varieties, and then waiting another 10 weeks for the results. Eventually, they got it right: large cucumbers that had the taste they wanted.

End of story? Not quite. The pickle-slicing equipment in the factory wasn't able to handle the large pickles, and it broke down when trying to slice the larger pickles. That meant that new equipment had to be designed and installed that was able to slice the large pickles.

Questions

1. What are some reasons consumers would be interested in large pickle slices? Name two reasons.
2. What lesson about new product development does this story tell?

Suppliers are still another source of ideas, and with increased emphasis on supply chains and supplier partnerships, suppliers are becoming an important source of ideas.

Research is another source of ideas for new or improved products or services. **Research and development (R&D)** refers to organized efforts that are directed toward increasing scientific knowledge and product or process innovation. Most of the advances in semiconductors, medicine, communications, and space technology can be attributed to R&D efforts at colleges and universities, research foundations, government agencies, and private enterprises.

R&D efforts may involve *basic research*, *applied research*, or *development*.

Basic research has the objective of advancing the state of knowledge about a subject, without any near-term expectation of commercial applications.

Applied research has the objective of achieving commercial applications.

Development converts the results of applied research into useful commercial applications.

Basic research, because it does not lead to near-term commercial applications, is generally underwritten by the government and large corporations. Conversely, applied research and development, because of the potential for commercial applications, appeals to a wide spectrum of business organizations.

The benefits of successful R&D can be tremendous. Some research leads to patents, with the potential of licensing and royalties. However, many discoveries are not patentable, or companies don't wish to divulge details of their ideas so they avoid the patent route. Even so, the first organization to bring a new product or service to the market generally stands to profit from it before the others can catch up. Early products may be priced higher because a temporary monopoly exists until competitors bring their versions out.

The costs of R&D can be high. Some companies spend more than \$1 million *a day* on R&D. Large companies in the automotive, computer, communications, and pharmaceutical industries spend even more. For example, IBM spends about \$6 billion a year, and Hewlett-Packard Enterprises about \$2 billion a year. Even so, critics say that many U.S. companies spend too little on R&D, a factor often cited in the loss of competitive advantage.

It is interesting to note that some companies are now shifting from a focus primarily on *products* to a more balanced approach that explores both product and *process* R&D.

Research and development (R&D) Organized efforts to increase scientific knowledge or product innovation.

Also, there is increasing recognition that technologies often go through life cycles, the same way that many products do. This can impact R&D efforts on two fronts. Sustained economic growth requires constant attention to competitive factors over a life cycle, and it also requires planning to be able to participate in the next-generation technology.

In certain instances, however, research may not be the best approach. The preceding reading illustrates a research success.

LO4.6 Discuss the importance of legal, ethical, and sustainability considerations in product and service design.

4.3 LEGAL AND ETHICAL CONSIDERATIONS

Designers must be careful to take into account a wide array of legal and ethical considerations. Generally, they are mandatory. Moreover, if there is a potential to harm the environment, then those issues also become important. Most organizations are subject to numerous government agencies that regulate them. Among the more familiar federal agencies are the Food and Drug Administration, the Occupational Health and Safety Administration, the Environmental Protection Agency, and various state and local agencies. Bans on cyclamates, red food dye, phosphates, and asbestos have sent designers scurrying back to their drawing boards to find alternative designs that were acceptable to both government regulators and customers. Similarly, automobile pollution standards and safety features, such as seat belts, air bags, safety glass, and energy-absorbing bumpers and frames, have had a substantial impact on automotive design. Much attention also has been directed toward toy design to remove sharp edges, small pieces that can cause choking, and toxic materials. The government further regulates construction, requiring the use of lead-free paint, safety glass in entranceways, access to public buildings for individuals with disabilities, and standards for insulation, electrical wiring, and plumbing.

Product liability can be a strong incentive for design improvements. **Product liability** is the responsibility of a manufacturer for any injuries or damages caused by a faulty product because of poor workmanship or design. Many business firms have faced lawsuits related to their products, including Firestone Tire & Rubber, Ford Motor Company, General Motors, tobacco companies, and toy manufacturers. Manufacturers also are faced with the implied warranties created by state laws under the **Uniform Commercial Code**, which says that products carry an implication of *merchantability* and *fitness*; that is, a product must be usable for its intended purposes.

The suits and potential suits have led to increased legal and insurance costs, expensive settlements with injured parties, and costly recalls. Moreover, increasing customer awareness of product safety can adversely affect product image and subsequent demand for a product.

Thus, it is extremely important to design products that are reasonably free of hazards. When hazards do exist, it is necessary to install safety guards or other devices for reducing accident potential, and to provide adequate warning notices of risks. Consumer groups, business firms, and various government agencies often work together to develop industrywide standards that help avoid some of the hazards.

Ethical issues often arise in the design of products and services; it is important for managers to be aware of these issues and for designers to adhere to ethical standards. Designers are often under pressure to speed up the design process and to cut costs. These pressures often require them to make trade-off decisions, many of which involve ethical considerations. One example of what can happen is “vaporware,” when a software company doesn’t issue a release of software as scheduled because it is struggling with production problems or bugs in the software. The company faces the dilemma of releasing the software right away or waiting until most of the bugs have been removed—knowing that the longer it waits, the more time will be needed before it receives revenues and the greater the risk of damage to its reputation.

Organizations generally want designers to adhere to guidelines such as the following:

- Produce designs that are consistent with the goals of the organization. For instance, if the company has a goal of high quality, don’t cut corners to save on costs, even in areas where it won’t be apparent to the customer.

Product liability The responsibility of a manufacturer for any injuries or damages caused by a faulty product.

Uniform Commercial Code A product must be suitable for its intended purpose.



TOM MARESCHAL/Alamy Stock Photo

The much anticipated Boeing 787 Dreamliner aircraft resumed flights after being grounded for more than three months for a battery defect. Aviation safety depends on well-maintained equipment and an expert flight crew who can handle emergencies as they come up.

- Give customers the value they expect.
- Make health and safety a primary concern. At risk are employees who will produce goods or deliver services, workers who will transport the products, customers who will use the products or receive the services, and the general public, which might be endangered by the products or services.

4.4 HUMAN FACTORS

Human factor issues often arise in the design of consumer products. Safety and liability are two critical issues in many instances, and they must be carefully considered. For example, the crashworthiness of vehicles is of much interest to consumers, insurance companies, automobile producers, and the government.

Another issue for designers to take into account is adding new features to their products or services. Companies in certain businesses may seek a competitive edge by adding new features. Although this can have obvious benefits, it can sometimes be “too much of a good thing,” and be a source of customer dissatisfaction. This “creeping featurism” is particularly evident in electronic products such as handheld devices that continue to offer new features, and more complexity, even while they are shrinking in size. This may result in low consumer ratings in terms of “ease of use.”

4.5 CULTURAL FACTORS

Product designers in companies that operate globally also must take into account any cultural differences of different countries or regions related to the product. This can result in different designs for different countries or regions, as illustrated by the following reading.



GREEN TEA ICE CREAM? KALE SOUP?

In order to be successful around the globe, McDonald's has regionalized its menu items to conform to local culinary preferences, laws, and religious traditions. Below are a sample of items that appear on McDonald's menus in various countries.

Canada: Poutine (french fries and cheese curds with brown gravy).

China: Chicken nuggets with chili garlic sauce, green tea ice cream.

Chile: Cheese empanadas.

Finland: Hamburgers with salsa and sour cream.

France: Beer for breakfast, burgers containing crispy peppers for lunch.

India: Spicy chicken wrap, rice bowls, masala wedges, tikki burgers.

Israel: Burgers are cooked over charcoal instead of fried.

Malaysia: Chicken porridge.

Netherlands: Fried chicken with peanut sauce.

Norway: Deep-fried fish, chicken salsa.

Philippines: Spaghetti, cheesy butter french fries.

Portugal: Kale soup, cream of carrot, bean and spinach soup.

Singapore: Salted egg yolk chicken burgers, curry sauce dip for chicken nuggets.

South Korea: Shrimp burger, pork burger, affogata (vanilla gelato with a shot of hot espresso).

Taiwan: Corn soup, rice patties.

Turkey: Spiced mincemeat patty, cold savory yogurt beverage mixed with salt.

Questions

1. What effects do cultural differences have on the design of fast-food offerings in this reading?
2. What functions in the organization are impacted by the differences in product offerings among different countries?

4.6 GLOBAL PRODUCT AND SERVICE DESIGN

Traditionally, product design has been conducted by members of the design team who are located in one facility or a few nearby facilities. However, organizations that operate globally are discovering advantages in global product design, which uses the combined efforts of a team of designers who work in different countries and even on different continents. Such *virtual teams* can provide a range of comparative advantages over traditional teams such as engaging the best human resources from around the world without the need to assemble them all in one place, and operating on a 24-hour basis, thereby decreasing the time-to-market. The use of global teams also allows for customer needs assessment to be done in more than one country with local resources, opportunities, and constraints to be taken into account. Global product design can provide design outcomes that increase the marketability and utility of a product. The diversity of an international team may yield different points of view and also ideas and information to enrich the design process. However, care must be taken in managing the diversity, because if it is mismanaged, it can lead to conflicts and miscommunications.

Advances in information technology have played a key role in the viability of global product design teams by enabling team members to maintain continual contact with each other and to instantaneously share designs and progress, and to transmit engineering changes and other necessary information.

4.7 ENVIRONMENTAL FACTORS: SUSTAINABILITY

LO4.7 Explain the purpose and goal of life-cycle assessment.

Cradle-to-grave assessment

The assessment of the environmental impact of a product or service throughout its useful life.

Product and service design is a focal point in the quest for sustainability. Key aspects include cradle-to-grave assessment, end-of-life programs, reduction of costs and materials used, reuse of parts of returned products, and recycling.

Cradle-to-Grave Assessment

Cradle-to-grave assessment, also known as life cycle analysis, is the assessment of the environmental impact of a product or service throughout its useful life, focusing on such factors as global warming (the amount of carbon dioxide released into the atmosphere), smog formation, oxygen depletion, and solid waste generation. For products, cradle-to-grave analysis takes into account impacts in every phase of a product's life cycle, from raw material extraction from the earth, or the growing and harvesting of plant materials, through fabrication of parts and assembly operations,

or other processes used to create products, as well as the use or consumption of the product, and final disposal at the end of a product's useful life. It also considers energy consumption, pollution and waste, and transportation in all phases. Although services generally involve less use of materials, cradle-to-grave assessment of services is nonetheless important, because services consume energy and involve many of the same or similar processes that products involve.

The goal of cradle-to-grave assessment is to choose products and services that have the least environmental impact, while still taking into account economic considerations. The procedures of cradle-to-grave assessment are part of the ISO 14000 environmental management standards, which are discussed in Chapter 9.

End-of-Life Programs

End-of-life (EOL) programs deal with products that have reached the end of their useful lives. The products include both consumer products and business equipment. The purpose of these programs is to reduce the dumping of products, particularly electronic equipment, in landfills or third-world countries, as has been the common practice, or incineration, which converts materials into hazardous air and water emissions and generates toxic ash. Although the programs are not limited to electronic equipment, that equipment poses problems because it typically contains toxic materials such as lead, cadmium, chromium, and other heavy metals. IBM provides a good example of the potential of EOL programs. Over the last 15 years, it has collected about 2 billion pounds of product and product waste.

The Three Rs: Reduce, Reuse, and Recycle

Designers often reflect on three particular aspects of potential cost savings and reducing environmental impact: reducing the use of materials through value analysis; refurbishing and then reselling returned goods that are deemed to have additional useful life, which is referred to as remanufacturing; and reclaiming parts of unusable products for recycling.

Reduce: Value Analysis

Value analysis refers to an examination of the *function* of parts and materials in an effort to reduce the cost and/or improve the performance of a product. Typical questions that would be asked as part of the analysis include: Could a cheaper part or material be used? Is the function necessary? Can the function of two or more parts or components be performed by a single part for a lower cost? Can a part be simplified? Could product specifications be relaxed, and would this result in a lower price? Could standard parts be substituted for nonstandard parts? Table 4.1 provides a checklist of questions that can guide a value analysis.

The following reading describes how Kraft Foods is working to reduce water and energy use, CO₂ and plant waste, and packaging.

1. Select an item that has a high annual dollar volume. This can be material, a purchased item, or a service.
2. Identify the function of the item.
3. Obtain answers to these kinds of questions:
 - a. Is the item necessary and have value, or can it be eliminated?
 - b. Are there alternative sources for the item?
 - c. Can the item be provided internally?
 - d. What are the advantages of the present arrangement?
 - e. What are the disadvantages of the present arrangement?
 - f. Could another material, part, or service be used instead?
 - g. Can specifications be less stringent to save cost or time?
 - h. Can two or more parts be combined?
 - i. Can more/less processing be done on the item to save cost or time?
 - j. Do suppliers/providers have suggestions for improvements?
 - k. Do employees have suggestions for improvements?
 - l. Can packaging be improved or made less costly?
4. Analyze the answers obtained above, as well as the answers to other questions that arise, and then make recommendations.

LO4.8 Explain the phrase “the 3 Rs.”

Value analysis Examination of the function of parts and materials in an effort to reduce cost and/or improve product performance.

TABLE 4.1
Overview of value analysis



KRAFT FOODS' RECIPE FOR SUSTAINABILITY

The threat of global warming and the desire to protect the environment has many companies embracing sustainability initiatives. Along the way, they are finding that, in many instances, there are cost savings in doing so.

Among them was the Kraft Foods Company prior to the spin off of its North American grocery business, known as Mondelez, and its merger with the H.J. Heinz Company. The Kraft Heinz Company is now one of the largest food and beverage companies in the world. Its brands include *Kraft*, *Heinz*, *ABC*, *Capri Sun*, *Jell-O*, *Kool-Aid*, *Lunchables*, *Maxwell House*, *Ore-Ida*, *Oscar Mayer*, *Philadelphia*, *Planters*, *Quero*, *Weight Watchers Smart Ones*, and *Velveeta*. According to the company's website, it "is dedicated to the sustainable health of our people, our planet and our Company" (kraftheinzcompany.com).

Prior to the merger of the two companies, both Kraft Foods and the H.J. Heinz Company were recognized for their sustainability efforts. Here, the focus is on some of Kraft's accomplishments prior to the merger. They provide insight into some of the cost savings that can stem from sustainability efforts, and serve as examples that others might wish to follow.

Some of Kraft's successes came from redesigned packaging. The goal was ambitious. It required more efficient packaging and a reduction in the amount of packaging material used. Kraft believed that the greatest opportunity to reduce the environmental impact of a package is early in the design phase. Their packaging designers worldwide critically considered the amount of packaging used, how much post-consumer material could be used, how much energy was used to create the packaging materials, how much CO₂ was generated as the materials were created and formed, and how well the package fit the product physically. According to Kraft's press releases at the time, examples and benefits of some packaging redesigns included:

- DiGiorno and California Pizza Kitchen pizzas: Using slimmer cartons that allow shipment of two extra pizza boxes per case and 14 percent more pizzas per pallet. This led to a savings of approximately 1.4 million pounds of packaging per year, and the ability to load more pizzas on each truck meant there were fewer trucks on the road and less fuel consumed.

- Oscar Mayer Deli Creations: Using 30 percent less paperboard than the previous design resulted in 1.2 million fewer pounds of packaging going to landfills.
- Kraft salad dressing: Using 19 percent less plastic per bottle translated to 3 million pounds fewer annually. Additionally, the new design allowed more bottles to be shipped per truckload, leading to an increase in transportation efficiency of 18 percent.

The company also worked to reduce water pollution/soil erosion and support biodiversity. Considering those successes, Kraft's recipe for sustainability is one that other companies should emulate.



James F. Quinn KRT/Newscom

Kraft Natural Cheese packaging zipper eliminates more than one million pounds of packaging per year.

Reuse: Remanufacturing

Remanufacturing Refurbishing used products by replacing worn-out or defective components.

An emerging concept in manufacturing is the remanufacturing of products. **Remanufacturing** refers to refurbishing used products by replacing worn-out or defective components, and reselling the products. This can be done by the original manufacturer, or another company. Among the products that have remanufactured components are automobiles, printers, copiers, cameras, computers, and telephones.

There are a number of important reasons for doing this. One is that a remanufactured product can be sold for about 50 percent of the cost of a new product. Another is that the process requires mostly unskilled and semiskilled workers. Also, in the global market, European lawmakers are increasingly requiring manufacturers to take back used products, because this means fewer products end up in landfills and there is less depletion of natural resources, such as raw materials and fuel.



BY LISA SPENCER

Trash piles up around the world as China's "National Sword" policy cuts off much of global recycling. Ships that brought Chinese goods to the United States used to return home full of America's recyclables to feed a booming recycling industry in China. The recycled metals, plastic pellets, glass, and paper were gobbled up by Chinese manufacturers in need of raw materials. However, corruption and environmental pollution by some of China's recycling operators led its government to shut the door on most of the world's scrap beginning in 2018 (Hook and Reed, 2018).

Whereas China and Hong Kong bought 60 percent of the G7's plastic waste in the first half of 2017, they took only 10 percent in the first half of 2018. Bales of plastic that U.S. recyclers previously sold for \$20 per ton may now instead cost cities \$10 per ton to dispose. While China still accepts some cardboard, plastic, glass, and scrap metal, it needs to be "ready to use" without much further cleaning or processing. The new standard is an impurity level of only 0.5 percent, something most U.S. recyclers cannot achieve. Furthermore, China no longer wants plastic water bottles. Now it wants plastic pellets, ready to use in its own manufacturing processes to make packaging, toys, and other goods (Hook and Reed, 2018). Recyclable scrap was America's biggest export to China by volume, and China bought 31 percent of U.S. scrap commodity exports. Municipalities now struggle with mountains of trash, which used to generate income but now do not (Phillips, 2018).

Where will the world's trash go? More than 270 million tons of global waste is recycled each year, much of it in China. Some now flows to other Southeast Asian countries such as Malaysia, Thailand, Vietnam, and Indonesia. Many new recycling businesses have sprung up to process shipments of recyclables, but local residents worry about the lack of regulation and the air and water pollution generated by these factories. These governments are now erecting barriers of their own to curb the recent influx of scrap coming into their countries. Shipping costs to these alternate countries

are much higher as well, because they lack the steady flow of empty returning containers and ships that enabled the cheap transport to China. Interestingly, some Chinese companies are now investing in American paper mills or plastic facilities to transfer their operations to the United States (Hook and Reed, 2018).

Recyclers, governments, and consumers around the world are being forced to rethink their use of plastics, paper waste, and e-waste. Some consumers in California, France, and Italy are looking to the past for alternatives to some of today's one-time-use packages and wasteful use of plastics. They bring their own multi-use bottles and bags to stores that sell items in bulk. Some municipalities are already changing rules about what can go into recycling bins, and many may be forced to charge customers more for weekly trash pickups. Cutting back on the creation of waste products may become more important to consumers and businesses who do not want to pay more and more for waste removal (Hook and Reed, 2018).

Questions

1. How have China's own sustainability issues and policies affected sustainability concerns worldwide?
2. What changes are being seen in the supply chain for recyclers of waste products?
3. What types of package design changes might be envisioned in the future to help reduce the amount of waste that is created?

Based on: Leslie Hook and John Reed, "The \$280 B Crisis Sparked by China Calling Time on Taking in 'Foreign Trash.'" *Financial Review*, October 31, 2018. <https://www.afr.com/news/the-280-billion-crisis-caused-when-china-called-time-on-foreign-trash-20181031-h17cfw>

Erica E. Phillips, "U.S. Recycling Companies Face Upheaval from China Scrap Ban." *The Wall Street Journal*, August 2, 2018. <https://www.wsj.com/articles/u-s-recycling-companies-face-upheaval-from-china-scrap-ban-1533231057>

Designing products so they can be more easily taken apart has given rise to yet another design consideration: **Design for disassembly (DFD)**.

Recycle

Recycling is sometimes an important consideration for designers. **Recycling** means recovering materials for future use. This applies not only to manufactured parts but also to materials used during production, such as lubricants and solvents. Reclaimed metal or plastic parts may be melted down and used to make different products. (See readings above and on next page.)

Companies recycle for a variety of reasons, including

1. Cost savings
2. Environment concerns
3. Environmental regulations

An interesting note: Companies that want to do business in the European Union must show that a specified proportion of their products are recyclable.

The pressure to recycle has given rise to the term **design for recycling (DFR)**, referring to product design that takes into account the ability to disassemble a used product to recover the recyclable parts.

Design for disassembly (DFD)

Design so that used products can be easily taken apart.

Recycling Recovering materials for future use.

Design for recycling (DFR)

Design that facilitates the recovery of materials and components in used products for reuse.



Maria's Market is the main supermarket in Recycle City. Maria tries to stock items and provide services in her store that reduce the amount of material going into the waste stream and encourage reuse and recycling.

Maria realized that the first and best thing she should do was to reduce the amount of waste her customers had to throw away after they bought products at her market.

Maria

To reduce the amount of waste and its impact on the environment, Maria began to stock items in the store that contained fewer harmful ingredients and used less packaging. To reduce packaging and wasted food, she created a section in the store where shoppers could buy food in bulk, measuring out the exact amounts they needed.

Maria also set up a program to reuse those things that could be reused, such as cardboard boxes that shoppers could use to carry their purchases and bring back to the store on their next visit. She also gave customers discounts for returning their plastic bags the next time they shopped and for bringing their own cloth sacks to carry groceries home.

Finally, Maria made sure that many of the items in the store could be easily recycled. She set up well-marked collection containers to make it easy for shoppers to participate in the market's recycling program. Maria knows that recycling keeps useful materials from going into landfills, helping to preserve the land in and around Recycle City for other uses, like parks and schools.

Paper or Plastic?

Should you ask for a paper or plastic bag at the checkout counter? There's no easy answer. The materials needed to make either bag come from our natural resources.

- Paper comes from wood, which comes from trees, which grow in the earth's soil.
- Plastic is made from petroleum, also known as fossil fuel. Petroleum is made by the decomposition (breaking down) of ancient plants and animals inside the earth.

The trees needed to make paper are considered renewable resources. That means more trees can be planted to take the place of trees that are cut down to make paper and other products. However, trees take many years to replace because they grow slowly. Once paper is made, it can be recycled and used to create more paper goods. Making it into new paper, though, uses water and energy.

Petroleum needed to make plastic is considered a non-renewable resource. Like aluminum, tin, and steel, petroleum is not renewable because it is the result of geological processes that take millions of years to complete. When used up, the earth's petroleum reserves will be gone for a long, long time. While plastic bags are easy to reuse, they're seldom recycled, and lots and lots of them get dumped into landfills.



Oscar Knott/Fogstock Images/Media Bakery

The best solution is to use a cloth bag or knapsack for grocery shopping, or to bring your old plastic or paper bag back to the store when you shop again. (Some stores, like Maria's Market in Recycle City, credit your grocery bill for reusing old bags because they don't have to buy as many new ones.) If you only purchase one or two items, you might not need a bag at all.

Recycling Igloos

In many parts of the country, supermarkets place recycling containers near the store to encourage their customers to recycle. (They can be any shape really, but Recycle City uses these brightly colored igloos because they're fun.)

These igloos are used to collect bottles, cans, and plastic from Maria's Market shoppers. Twice a week, trucks from the local Materials Recovery Facility come by to empty the igloos and take the items for recycling.

Cardboard Boxes

The cardboard boxes used to ship food to Maria's Market can be put to a variety of other uses once the food has been unpacked. The folks at the market let Recycle City residents come by and pick up cartons for storing things or moving to a new home. Any cartons that aren't claimed by the residents are broken down and put into a pile so they can be collected, recycled, and made into other things, such as new boxes, paper bags, building insulation, animal bedding, or packaging materials.

Reduced Packaging

When the buyers at Maria's Market place orders to restock the store, they try to order items with very little packaging, or that use ecological packaging (ones requiring as little energy and as few resources as possible to produce).

Maria's buyers also try to stock products that come in refillable containers. Products that don't harm the environment and come in ecologically friendly packages are called green products.

Packaging that isn't environmentally friendly includes products that are wrapped in several layers of plastic, use plastic foam, or have individually wrapped packages inside of a larger wrapped package.

Maria's buyers let the manufacturers who make products for the grocery shelves know that they and their Recycle City customers would rather buy products wrapped in environmentally friendly packages than ones that aren't. Using this kind of packaging is good for the manufacturer's business.

Bulk and Fresh Foods

Packaging materials make up more than 30 percent of all consumer waste. Maria's Market offers shoppers many fresh foods and bulk foods to help reduce the amount of waste from too much packaging.

Fresh foods, such as bananas, oranges, and nuts, come in their own natural packaging and are excellent sources of nutrition.

Bulk items and food purchased in bulk quantities allow Maria's shoppers to decide exactly how much they want to keep on hand.

For small needs, folks measure out the exact quantity they want, helping to reduce food waste. For larger needs, they can buy bulk quantities, which usually use less packaging material and cost less.

When purchasing fresh foods or buying in bulk, shoppers can put their purchases into refillable containers they bring to the store or into the recyclable or reusable bags Maria provides.

Paper Towels and Other Paper Items

Many paper products on the shelves today have already been recycled. Buying recycled products saves valuable natural resources and helps to create a market for those materials. When manufacturers know that shoppers want recyclable goods, they will make more of them.

In Maria's Market, the popularity of paper towels and toilet paper made from recycled materials ensures that fewer new trees have to be cut down to produce new products.

Source: Excerpted from <https://www3.epa.gov/recyclecity/market.htm>

4.8 OTHER DESIGN CONSIDERATIONS

Aside from legal, ethical, environmental, and human considerations, designers must also take into account product or service life cycles, how much standardization to incorporate, product or service reliability, and the range of operating conditions under which a product or service must function. These topics are discussed in this section. We begin with life cycles.

Strategies for Product or Service Life Stages

Most, but not all, products and services go through a series of stages over their useful life, sometimes referred to as their life cycle, as shown in Figure 4.1. Demand typically varies by phase. Different phases call for different strategies. In every phase, forecasts of demand and cash flow are key inputs for strategy.

When a product or service is introduced, it may be treated as a curiosity item. Many potential buyers may suspect that all the bugs haven't been worked out and that the price may drop after the introductory period. Strategically, companies must carefully weigh the trade-offs in getting all the bugs out versus getting a leap on the competition, as well as getting to market at an advantageous time. For example, introducing new high-tech products or features during peak back-to-school buying periods or holiday buying periods can be highly desirable.

It is important to have a reasonable forecast of initial demand so an adequate supply of product or an adequate service capacity is in place.

Over time, design improvements and increasing demand yield higher reliability and lower costs, leading the growth in demand. In the growth phase, it is important to obtain accurate projections of the demand growth rate and how long that will persist, and then to ensure that capacity increases coincide with increasing demand.

In the next phase, the product or service reaches maturity, and demand levels off. Few, if any, design changes are needed. Generally, costs are low and productivity is high. New uses for products or services can extend their life and increase the market size. Examples include baking soda, duct tape, and vinegar. The maker of LEGOs has found a way to grow its market, as described in the following reading.

In the decline phase, decisions must be made about whether to discontinue a product or service and replace it with new ones or abandon the market, or to attempt to find new uses or new users for the existing product or service. For example, duct tape and baking

LO4.9 Briefly describe the phases in product design and development.



LEGO A/S IN THE PINK

Lego A/S overcame the recent doldrums in the toy market, as well as new competition in the building-block segment to continue its market success, increasing revenues and achieving a close tie for the No. 2 slot in the global toy business.

“The Danish toy maker enjoyed sustained success for its popular LEGO City and LEGO Star Wars sets. Its new LEGO Friends theme, targeting girls, sold twice as well as initial expectations and helped triple sales to girls.”

Questions

Can you think of other companies that have used new colors to extend or grow the market for their products?

Source: “Lego Shrugs Off Toy-Market Blues,” *The Wall Street Journal*, February 21, 2013.

FIGURE 4.1

Products or services often go through stages over time

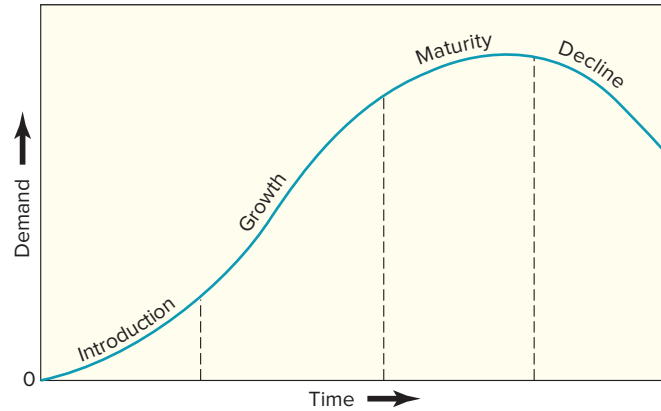

A. Astes/Alamy Stock Photo

International Design Excellence Award Winner: The Technogym Recline Personal is a recumbent bike that integrates ergonomic design, cardiovascular exercise, and entertainment, making it suitable for the home or office.

soda are two products that have been employed well beyond their original uses of taping heating and cooling ducts and cooking. The advantages of keeping existing products or services can be tremendous. The same workers can produce the product or provide the service using much of the same equipment, the same supply chain, and perhaps the same

distribution channels. Consequently, costs tend to be very low, and additional resource needs and training needs are low.

Some products do not exhibit life cycles: wooden pencils; paper clips; nails; knives, forks, and spoons; drinking glasses; and similar items. However, most new products do.

Some service life cycles are related to the life cycles of products. For example, as older products are phased out, services such as installation and repair of the older products also phase out.

Wide variations exist in the amount of time a particular product or service takes to pass through a given phase of its life cycle: Some pass through various stages in a relatively short period; others take considerably longer. Often, it is a matter of the basic *need* for the item and the *rate of technological change*. Some toys, novelty items, and style items have a life cycle of less than one year, whereas other, more useful items, such as clothes washers and dryers, may last for many years before yielding to technological change.

Product Life Cycle Management

Product life cycle management (PLM) is a systematic approach to managing the series of changes a product goes through, from its conception, design, and development, through production and any redesign, to its end of life. PLM incorporates everything related to a particular product. That includes data pertaining to production processes, business processes, people, and anything else related to the product.

PLM software can be used to automate the management of product-related data and integrate the data with other business processes, such as enterprise resource planning (discussed in Chapter 12). A goal of PLM is to eliminate waste and improve efficiency. For example, PLM is considered to be an integral part of lean production (discussed in Chapter 14).

There are three phases of PLM application:

- Beginning of life, which involves design and development;
- Middle of life, which involves working with suppliers, managing product information and warranties; and
- End of life, which involves strategies for product discontinuance, disposal, or recycling.

Although PLM is generally associated with manufacturing, the same management structure can be applied to software development and services.

Degree of Standardization

An important issue that often arises in both product/service design and process design is the degree of standardization. **Standardization** refers to the extent to which there is absence of variety in a product, service, or process. Standardized products are made in large quantities of identical items; calculators, computers, and 2 percent milk are examples. Standardized service implies that every customer or item processed receives essentially the same service. An automatic car wash is a good example: Each car, regardless of how clean or dirty it is, receives the same service. Standardized processes deliver standardized service or produce standardized goods.

Standardization carries a number of important benefits, as well as certain disadvantages. Standardized products are immediately available to customers. Standardized products mean *interchangeable parts*, which greatly lower the cost of production while increasing productivity and making replacement or repair relatively easy compared with that of customized parts. Design costs are generally lower. For example, automobile producers standardize key components of automobiles across product lines; components such as brakes, electrical systems, and other “under-the-skin” parts would be the same for all car models. By reducing variety, companies save time and money while increasing the quality and reliability of their products.

Another benefit of standardization is reduced time and cost to train employees and reduced time to design jobs. Similarly, the scheduling of work, inventory handling, and purchasing and accounting activities become much more routine, and quality is more consistent.

Lack of standardization can at times lead to serious difficulties and competitive struggles. For example, the use of the English system of measurement by U.S. manufacturers, while most of the rest of the world’s manufacturers use the metric system, has led to problems

LO4.10 Discuss several key issues in product or service design.

Product life cycle management (PLM) A systematic approach to managing the series of changes a product goes through, from its conception to its end-of-life.

Standardization Extent to which a product, service, or process lacks variety.

TABLE 4.2

Advantages and disadvantages of standardization

Advantages	<ol style="list-style-type: none"> 1. Fewer parts to deal with in inventory and in manufacturing. 2. Reduced training costs and time. 3. More routine purchasing, handling, and inspection procedures. 4. Orders fillable from inventory. 5. Opportunities for long production runs and automation. 6. Need for fewer parts justifies increased expenditures on perfecting designs and improving quality control procedures.
Disadvantages	<ol style="list-style-type: none"> 1. Designs may be frozen with too many imperfections remaining. 2. High cost of design changes increases resistance to improvements. 3. Decreased variety results in less consumer appeal.

in selling U.S. goods in foreign countries and in buying foreign machines for use in the United States. This may make it more difficult for U.S. firms to compete in the European Union.

Standardization also has disadvantages. A major one relates to the reduction in variety. This can limit the range of customers to whom a product or service appeals. And that creates a risk that a competitor will introduce a better product or greater variety and realize a competitive advantage. Another disadvantage is that a manufacturer may freeze (standardize) a design prematurely and, once the design is frozen, find compelling reasons to resist modification.

Obviously, designers must consider important issues related to standardization when making choices. The major advantages and disadvantages of standardization are summarized in Table 4.2.

LO4.10 Discuss several key issues in product or service design.

Designing for Mass Customization

Companies like standardization because it enables them to produce high volumes of relatively low-cost products, albeit products with little variety. Customers, on the other hand, typically prefer more variety, although they like the low cost. The question for producers is how to resolve these issues without (1) losing the benefits of standardization, and (2) incurring a host of problems that are often linked to variety. These include increasing the resources needed to achieve design variety; increasing variety in the production process, which would add to the skills necessary to produce products, causing a decrease in productivity; creating an additional inventory burden during and after production, by having to carry replacement parts for the increased variety of parts; and adding to the difficulty of diagnosing and repairing product failures. The answer, at least for some companies, is **mass customization**, a strategy of producing standardized goods or services, but incorporating some degree of customization in the final product or service. Several tactics make this possible. One is *delayed differentiation*, and another is *modular design*. (See reading on following page.)

Mass customization A strategy of producing basically standardized goods, but incorporating some degree of customization.

Delayed differentiation The process of producing, but not quite completing, a product or service until customer preferences are known.

Delayed differentiation is a *postponement* tactic: the process of producing, but not quite completing, a product or service, postponing completion until customer preferences or specifications are known. There are a number of variations of this. In the case of goods, almost-finished units might be held in inventory until customer orders are received, at which time customized features are incorporated, according to customer requests. For example, furniture makers can produce dining room sets, but not apply stain, allowing customers a choice of stains. Once the choice is made, the stain can be applied in a relatively short time, thus eliminating a long wait for customers, giving the seller a competitive advantage. Similarly, various e-mail or internet services can be delivered to customers as standardized packages, which can then be modified according to the customer's preferences. HP printers that are made in the United States but intended for foreign markets are mostly completed in domestic assembly plants and then finalized closer to the country of use. The result of delayed differentiation is a product or service with customized features that can be quickly produced, appealing to the customers' desire for variety and speed of delivery, and yet one that for the most part is standardized, enabling the producer to realize the benefits of standardized production. This technique is not new. Manufacturers of men's clothing, for example, produce suits with pants that have legs that are unfinished, allowing customers to tailor choices as to the exact length and whether to have cuffs or no cuffs. What is new is the extent to which business organizations are finding ways to incorporate this concept into a broad range of products and services.



FAST-FOOD CHAINS ADOPT MASS CUSTOMIZATION

Pulled pork sandwiches are proving popular at many chain restaurants, including Wendy's, Buffalo Wild Wings, and Burger King. Because pulled pork typically takes about 4 hours to cook, it's not a food most folks are likely to cook at home. And once cooked, sandwiches can easily be assembled to order (i.e., delayed differentiation) using any of a large number of sauces or seasonings. Customer appeal is obvious. The advantages for fast-food restaurants include simplified menus, minimal training requirements, and little need for new equipment.

Questions

1. What two major benefits do customers get from delayed differentiation?
2. Can you think of another food product that might lend itself to delayed differentiation, and therefore end up as a popular fast-food item?

Source: Based on "Fast-Food Chains Are Pigging Out." *Businessweek*, October 12–October 18, 2015, pp. 22–23.

Modular design is a form of standardization. Modules represent groupings of component parts into subassemblies, usually to the point where the individual parts lose their separate identity. One familiar example of modular design is computers, which have modular parts that can be replaced if they become defective. By arranging modules in different configurations, different computer capabilities can be obtained. For mass customization, modular design enables producers to quickly assemble products with modules to achieve a customized configuration for an individual customer, avoiding the long customer wait that would occur if individual parts had to be assembled. Dell Computers has successfully used this concept to become a dominant force in the PC industry by offering consumers the opportunity to configure modules according to their own specifications. Many other computer manufacturers now use a similar approach. Modular design also is found in the construction industry. One firm in Rochester, New York, makes prefabricated motel rooms complete with wiring, plumbing, and even room decorations in its factory and then moves the complete rooms by rail to the construction site, where they are integrated into the structure.

One advantage of modular design of equipment compared with nonmodular design is that failures are often easier to diagnose and remedy because there are fewer pieces to investigate. Similar advantages are found in the ease of repair and replacement; the faulty module is

Modular design A form of standardization in which component parts are grouped into modules that are easily replaced or interchanged.



Liu Zheng/ColorChinaPhoto/AP Images

Employees on the production line at the new Dell Global Operation Facility in China. With the capacity to produce up to seven million units a year, the site will manufacture electronics for the Chinese market as well as markets in Europe and the United States.

conveniently removed and replaced with a good one. The manufacture and assembly of modules generally involve simplifications: Fewer parts are involved, so purchasing and inventory control become more routine, fabrication and assembly operations become more standardized, and training costs often are relatively low.

The main disadvantages of modular design stem from the decrease in variety: The number of possible configurations of modules is much less than the number of possible configurations based on individual components. Another disadvantage that is sometimes encountered is the inability to disassemble a module in order to replace a faulty part; the entire module must be scrapped—usually at a higher cost.

LO4.10 Discuss several key issues in product or service design.

Reliability The ability of a product, part, or system to perform its intended function under a prescribed set of conditions.

Failure Situation in which a product, part, or system does not perform as intended.

Normal operating conditions

The set of conditions under which an item's reliability is specified.

Reliability

Reliability is a measure of the ability of a product, a part, a service, or an entire system to perform its intended function under a prescribed set of conditions. The importance of reliability is underscored by its use by prospective buyers in comparing alternatives, and by sellers as one determinant of price. Reliability also can have an impact on repeat sales, reflect on the product's image, and, if it is too low, create legal implications. Reliability is also a consideration for sustainability: The higher the reliability of a product, the fewer the resources that will be needed to maintain it, and the less frequently it will involve the three Rs.

The term **failure** is used to describe a situation in which an item does not perform as intended. This includes not only instances in which the item does not function at all, but also instances in which the item's performance is substandard or it functions in a way not intended. For example, a smoke alarm might fail to respond to the presence of smoke (not operate at all), it might sound an alarm that is too faint to provide an adequate warning (substandard performance), or it might sound an alarm even though no smoke is present (unintended response).

Reliabilities are always specified with respect to certain conditions, called **normal operating conditions**. These can include load, temperature, and humidity ranges, as well as operating procedures and maintenance schedules. Failure of users to heed these conditions often results in premature failure of parts or complete systems. For example, using a passenger car to tow heavy loads will cause excess wear and tear on the drive train; driving over potholes or curbs often results in untimely tire failure; and using a calculator to drive nails might have a marked impact on its usefulness for performing mathematical operations.

Improving Reliability Reliability can be improved in a number of ways, some of which are listed in Table 4.3.

Because overall system reliability is a function of the reliability of individual components, improvements in their reliability can increase system reliability. Unfortunately, inadequate production or assembly procedures can negate even the best of designs, and this is often a source of failures. System reliability can be increased by the use of backup components. Failures in actual use often can be reduced by upgrading user education and refining maintenance recommendations or procedures. Finally, it may be possible to increase the overall reliability of the system by simplifying the system (thereby reducing the number of components that could cause the system to fail) or altering component relationships (e.g., increasing the reliability of interfaces).

A fundamental question concerning improving reliability is: How much reliability is needed? Obviously, the reliability needed for a household light bulb isn't in the same category

TABLE 4.3

Potential ways to improve reliability

1. Improve component design.
2. Improve production and/or assembly techniques.
3. Improve testing.
4. Use backups.
5. Improve preventive maintenance procedures.
6. Improve user education.
7. Improve system design.

as the reliability needed for an airplane. So the answer to the question depends on the potential benefits of improvements and on the cost of those improvements. Generally speaking, reliability improvements become increasingly costly. Thus, although benefits initially may increase at a much faster rate than costs, the opposite eventually becomes true. The optimal level of reliability is the point where the incremental benefit received equals the incremental cost of obtaining it. In the short term, this trade-off is made in the context of relatively fixed parameters (e.g., costs). However, in the longer term, efforts to improve reliability and reduce costs can lead to higher optimal levels of reliability.

Robust Design

Some products or services will function as designed only within a narrow range of conditions, while others will perform as designed over a much broader range of conditions. The latter have **robust design**. Consider a pair of fine leather boots—obviously not made for trekking through mud or snow. Now consider a pair of heavy rubber boots—just the thing for mud or snow. The rubber boots have a design that is more *robust* than that of the fine leather boots.

The more robust a product or service, the less likely it will fail due to a change in the environment in which it is used or in which it is performed. Hence, the more designers can build robustness into the product or service, the better it should hold up, resulting in a higher level of customer satisfaction.

A similar argument can be made for robust design as it pertains to the production process. Environmental factors can have a negative effect on the quality of a product or service. The more resistant a design is to those influences, the less likely is a negative effect. For example, many products go through a heating process: food products, ceramics, steel, petroleum products, and pharmaceutical products. Furnaces often do not heat uniformly; heat may vary either by position in an oven or over an extended period of production. One approach to this problem might be to develop a superior oven; another might be to design a system that moves the product during heating to achieve uniformity. A robust-design approach would develop a product that is unaffected by minor variations in temperature during processing.

Taguchi's Approach Japanese engineer Genichi Taguchi's approach is based on the concept of robust design. His premise is that it is often easier to design a product that is insensitive to environmental factors, either in manufacturing or in use, than to control the environmental factors.

The central feature of Taguchi's approach—and the feature used most often by U.S. companies—is *parameter design*. This involves determining the specification settings for both the product and the process that will result in robust design in terms of manufacturing variations, product deterioration, and conditions during use.

The Taguchi approach modifies the conventional statistical methods of experimental design. Consider this example. Suppose a company will use 12 chemicals in a new product it intends to produce. There are two suppliers for these chemicals, but the chemical concentrations vary slightly between the two suppliers. Classical design of experiments would require $2^{12} = 4,096$ test runs to determine which combination of chemicals would be optimum. Taguchi's approach would involve only testing a portion of the possible combinations. Relying on experts to identify the variables that would be most likely to affect important performance, the number of combinations would be dramatically reduced, perhaps to, say, 32. Identifying the best combination in the smaller sample might be a near-optimal combination instead of the optimal combination. The value of this approach is its ability to achieve major advances in product or process design fairly quickly, using a relatively small number of experiments.

Critics charge that Taguchi's methods are inefficient and incorrect, and often lead to non-optimal solutions. Nonetheless, his methods are widely used and have been credited with helping to achieve major improvements in U.S. products and manufacturing processes.

LO4.10 Discuss several key issues in product or service design.

Robust design Design that results in products or services that can function over a broad range of conditions.

LO4.10 Discuss several key issues in product or service design.

Degree of Newness

Product or service design change can range from the modification of an existing product or service to an entirely new product or service:

1. Modification of an existing product or service
2. Expansion of an existing product line or service offering
3. Clone of a competitor’s product or service
4. New product or service

The degree of change affects the newness to the organization and the newness to the market. For the organization, a low level of newness can mean a fairly quick and easy transition to producing the new product, while a high level of newness would likely mean a slower and more difficult, and therefore more costly, transition. For the market, a low level of newness would mean little difficulty with market acceptance, but possibly low profit potential. Even in instances of low profit potential, organizations might use this strategy to maintain market share. A high level of newness, on the other hand, might mean more difficulty with acceptance, or it might mean a rapid gain in market share with a high potential for profits. Unfortunately, there is no way around these issues. It is important to carefully assess the risks and potential benefits of any design change, taking into account clearly identified customer wants.

Quality Function Deployment

Obtaining input from customers is essential to assure that they will want what is offered for sale. Although obtaining input can be informal through discussions with customers, there is a formal way to document customer wants. **Quality function deployment (QFD)** is a structured approach for integrating the “voice of the customer” into both the product and service development process. The purpose is to ensure that customer requirements are factored into every aspect of the process. Listening to and understanding the customer is the central feature of QFD. Requirements often take the form of a general statement such as, “It should be easy to adjust the cutting height of the lawn mower.” Once the requirements are known, they must be translated into technical terms related to the product or service. For example, a statement about changing the height of the lawn mower may relate to the mechanism used to accomplish that, its position, instructions for use, tightness of the spring that controls the mechanism, or materials needed. For manufacturing purposes, these must be related to the materials, dimensions, and equipment used for processing.

The structure of QFD is based on a set of matrices. The main matrix relates customer requirements (what) and their corresponding technical requirements (how). This matrix is illustrated in Figure 4.2. The matrix provides a structure for data collection.

Quality function deployment (QFD) An approach that integrates the “voice of the customer” into both product and service development.

FIGURE 4.2
An example of the house of quality: the main QFD matrix

Source: Ernst and Young Consulting Group, *Total Quality* (Homewood, IL: Dow-Jones Irwin, 1991), p. 121.

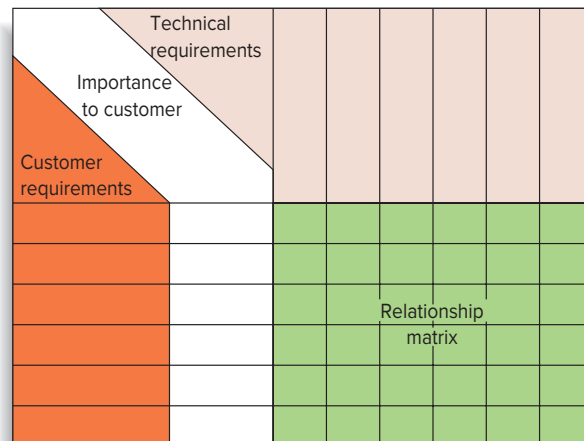

Additional features are usually added to the basic matrix to broaden the scope of analysis. Typical additional features include importance weightings and competitive evaluations. A correlational matrix is usually constructed for technical requirements; this can reveal conflicting technical requirements. With these additional features, the set of matrices has the form illustrated in Figure 4.3. It is often referred to as the *house of quality* because of its house-like appearance.

An analysis using this format is shown in Figure 4.4. The data relate to a commercial printer (customer) and the company that supplies the paper. At first glance, the display appears complex. It contains a considerable amount of information for product and process planning. Therefore, let's break it up into separate parts and consider them one at a time. To start, a key part is the list of customer requirements on the left side of the figure. Next, note the technical requirements, listed vertically near the top. The key relationships and their degree of importance are shown in the center of the figure. The circle with a dot inside indicates the strongest positive relationship; that is, it denotes the most important technical requirements for satisfying customer requirements. Now look at the "importance to customer" numbers that are shown next to each customer requirement (3 is the most important). Designers will take into account the importance values and the strength of correlation in determining where to focus the greatest effort.

Next, consider the correlation matrix at the top of the "house." Of special interest is the strong negative correlation between "paper thickness" and "roll roundness." Designers will have to find some way to overcome that or make a trade-off decision.

On the right side of the figure is a competitive evaluation comparing the supplier's performance on the customer requirements with each of the two key competitors (A and B). For example, the supplier (X) is worst on the first customer requirement and best on the third customer requirement. The line connects the X performances. Ideally, design will cause all of the Xs to be in the highest positions.

Across the bottom of Figure 4.4 are importance weightings, target values, and technical evaluations. The technical evaluations can be interpreted in a manner similar to that of the competitive evaluations (note the line connecting the Xs). The target values typically contain technical specifications, which we will not discuss. The importance weightings are the sums of values assigned to the relationships (see the lower right-hand key for relationship weights). The 3 in the first column is the product of the importance to the customer, 3, and the small (Δ) weight, 1. The importance weightings and target evaluations help designers focus on desired results. In this example, the first technical requirement has the lowest importance weighting, while the next four technical requirements all have relatively high importance weightings.

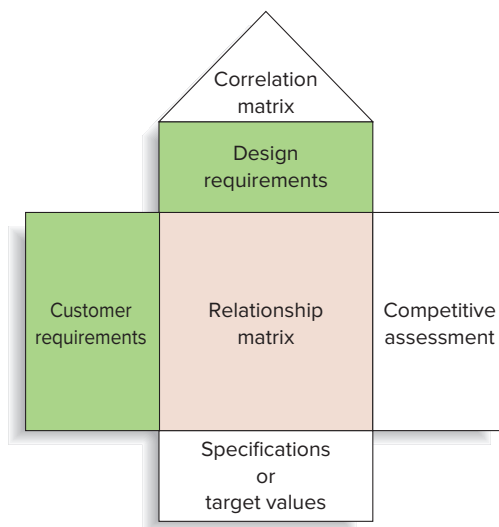
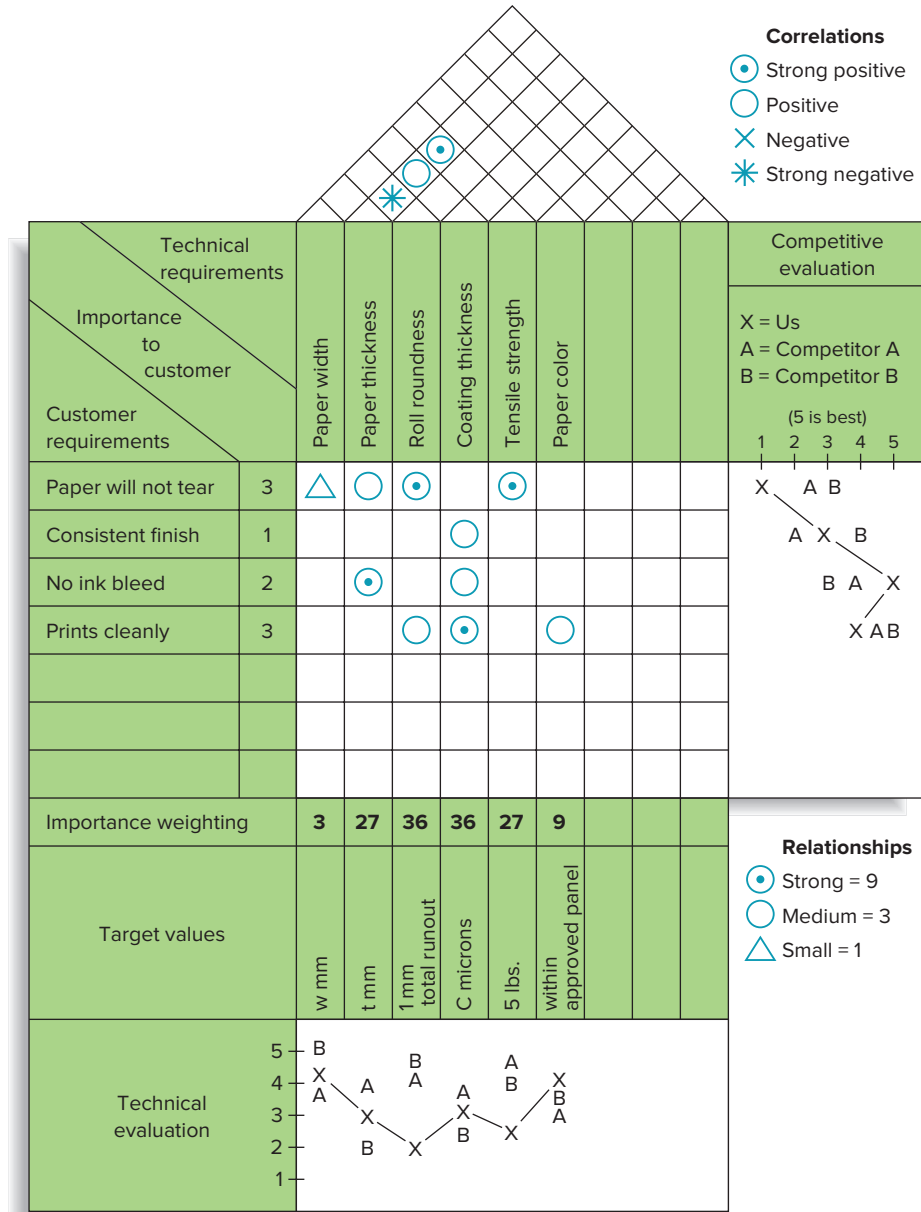

FIGURE 4.3
The house of quality

FIGURE 4.4

An example of the house of quality



The house of quality approach involves a sequence of “houses,” beginning with design characteristics, which leads to specific components, then production processes, and finally, a quality plan. The sequence is illustrated in Figure 4.5. Although the details of each house are beyond the scope of this text, Figure 4.5 provides a conceptual understanding of the progression involved.

LO4.10 Discuss several key issues in product or service design.

The Kano Model

The *Kano model* is a theory of product and service design developed by Dr. Noriaki Kano, a Japanese professor, who offered a perspective on customer perceptions of quality different from the traditional view that “more is better.” Instead, he proposed different categories of quality and posited that understanding them would better position designers to assess and address quality needs. His model provides insights into the attributes that are perceived to be

FIGURE 4.5

The house of quality sequence

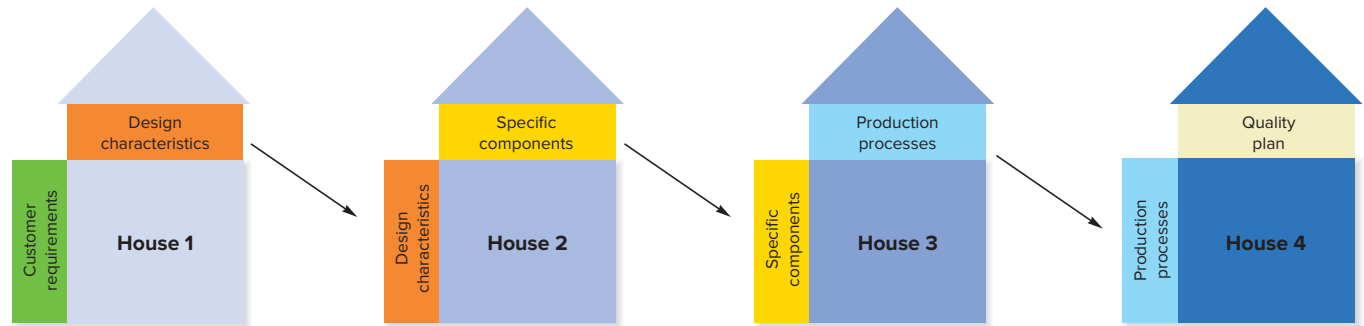

important to customers. The model employs three definitions of quality: basic, performance, and excitement.

Basic quality refers to customer requirements that have only a limited effect on customer satisfaction if present, but lead to dissatisfaction if not present. For example, putting a very short cord on an electrical appliance will likely result in customer dissatisfaction, but beyond a certain length (e.g., 4 feet), adding more cord will not lead to increased levels of customer satisfaction. Performance quality refers to customer requirements that generate satisfaction or dissatisfaction in proportion to their level of functionality and appeal. For example, increasing the tread life of a tire or the amount of time house paint will last will add to customer satisfaction. Excitement quality refers to a feature or attribute that was unexpected by the customer and causes excitement (the “wow” factor), such as a voucher for dinner for two at the hotel restaurant when checking in. Figure 4.6A portrays how the three definitions of quality influence customer satisfaction or dissatisfaction relative to the degree of implementation. Note that features that are perceived by customers as basic quality result in dissatisfaction if they are missing or at low levels, but do not result in customer satisfaction if they are present, even at high levels. Performance factors can result in satisfaction or dissatisfaction, depending on the degree to which they are present. Excitement factors, because they are unexpected, do not result in dissatisfaction when they are absent or at low levels, but have the potential for disproportionate levels of satisfaction if they are present.

Over time, features that excited become performance features, and performance features soon become basic quality features, as illustrated in Figure 4.6B. The rates at which various design elements are migrating is an important input from marketing that will enable designers to continue to satisfy and delight customers and not waste efforts on improving what have become basic quality features.

The lesson of the Kano model is that design elements that fall into each aspect of quality must first be determined. Once basic needs have been met, additional efforts in those areas should not be pursued. For performance features, cost–benefit analysis comes into play, and these features should be included as long as the benefit exceeds the cost. Excitement features pose somewhat of a challenge. Customers are not likely to indicate excitement factors in surveys because they don’t know that they want them. However, small increases in such factors produce disproportional increases in customer satisfaction and generally increase brand loyalty, so it is important for companies to strive to identify and include these features when economically feasible.

The Kano model can be used in conjunction with QFD, as well as in Six Sigma projects (see Chapter 9 for a discussion of Six Sigma).

FIGURE 4.6A
The Kano model



FIGURE 4.6B
As time passes, excitement factors become performance factors, and performance factors become basic factors

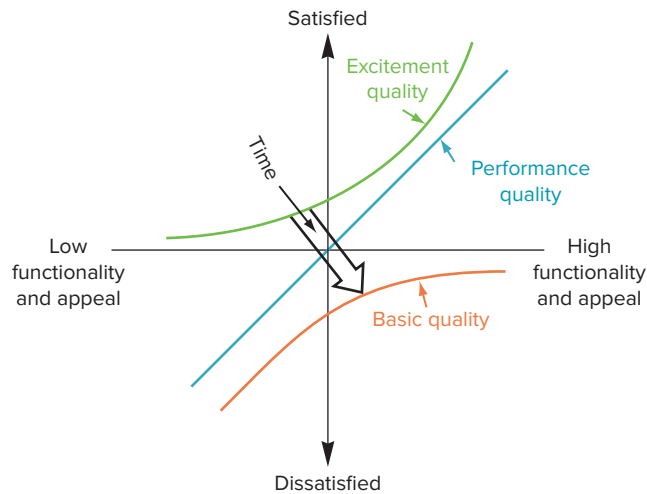

4.9 PHASES IN PRODUCT DESIGN AND DEVELOPMENT

Product design and development generally proceeds in a series of phases (see Table 4.4).

Feasibility analysis. Feasibility analysis entails market analysis (demand), economic analysis (development cost and production cost, profit potential), and technical analysis (capacity requirements and availability, and the skills needed). Also, it is necessary to answer the question: Does it fit with the mission? It requires collaboration among marketing, finance, accounting, engineering, and operations.

Product specifications. This involves detailed descriptions of what is needed to meet (or exceed) customer wants, and requires collaboration between legal, marketing, and operations.

TABLE 4.4
Phases in the product development process

1. Feasibility analysis	5. Design review
2. Product specifications	6. Market test
3. Process specifications	7. Product introduction
4. Prototype development	8. Follow-up evaluation

Process specifications. Once product specifications have been set, attention turns to specifications for the process that will be needed to produce the product. Alternatives must be weighed in terms of cost, availability of resources, profit potential, and quality. This involves collaboration between accounting and operations.

Prototype development. With product and process specifications complete, one (or a few) units are made to see if there are any problems with the product or process specifications.

Design review. At this stage, any necessary changes are made or the project is abandoned. Marketing, finance, engineering, design, and operations collaborate to determine whether to proceed or abandon.

Market test. A market test is used to determine the extent of consumer acceptance. If unsuccessful, the product returns to the design review phase. This phase is handled by marketing.

Product introduction. The new product is promoted. This phase is handled by marketing.

Follow-up evaluation. Based on user feedback, changes may be made or forecasts refined. This phase is handled by marketing.

4.10 DESIGNING FOR PRODUCTION

In this section, you will learn about design techniques that have greater applicability for the design of products than the design of services. Even so, you will see that they do have some relevance for service design. The topics include concurrent engineering, computer-assisted design, designing for assembly and disassembly, and the use of components for similar products.

Concurrent Engineering

To achieve a smoother transition from product design to production, and to decrease product development time, many companies are using *simultaneous development*, or concurrent engineering. In its narrowest sense, **concurrent engineering** means bringing design and manufacturing engineering people together early in the design phase to simultaneously develop the product and the processes for creating the product. More recently, this concept has been enlarged to include manufacturing personnel (e.g., materials specialists) and marketing and purchasing personnel in loosely integrated, cross-functional teams. In addition, the views of suppliers and customers are frequently sought. The purpose, of course, is to achieve product designs that reflect customer wants, as well as manufacturing capabilities.

Traditionally, designers developed a new product without any input from manufacturing, and then turned over the design to manufacturing, which would then have to develop a process for making the new product. This “over-the-wall” approach created tremendous challenges for manufacturing, generating numerous conflicts and greatly increasing the time needed to successfully produce a new product. It also contributed to an “us versus them” mentality.

For these and similar reasons, the simultaneous development approach has great appeal. Among the key advantages of this approach are the following:

1. Manufacturing personnel are able to identify production capabilities and capacities. Very often, they have some latitude in design in terms of selecting suitable materials and processes. Knowledge of production capabilities can help in the selection process. In addition, cost and quality considerations can be greatly influenced by design, and conflicts during production can be greatly reduced.
2. Design or procurement of critical tooling, some of which might have long lead times, can occur early in the process. This can result in a major shortening of the product development process, which could be a key competitive advantage.
3. The technical feasibility of a particular design or a portion of a design can be assessed early on. Again, this can avoid serious problems during production.
4. The emphasis can be on *problem* resolution instead of *conflict* resolution.

Concurrent engineering

Bringing engineering design and manufacturing personnel together early in the design phase.

However, despite the advantages of concurrent engineering, a number of potential difficulties exist in this co-development approach. Two key ones are the following:

- Long-standing boundaries between design and manufacturing can be difficult to overcome. Simply bringing a group of people together and thinking they will be able to work together effectively is probably naive.
- There must be extra communication and flexibility if the process is to work, and these can be difficult to achieve.

Hence, managers should plan to devote special attention if this approach is to work.

Computer-Aided Design (CAD)

Computer-aided design (CAD)

Product design using computer graphics.

Computers are increasingly used for product design. **Computer-aided design (CAD)** uses computer graphics for product design. The designer can modify an existing design or create a new one on a monitor by means of a light pen, a keyboard, a joystick, or a similar device. Once the design is entered into the computer, the designer can maneuver it on the screen: It can be rotated to provide the designer with different perspectives, it can be split apart to give the designer a view of the inside, and a portion of it can be enlarged for closer examination. The designer can obtain a printed version of the completed design and file it electronically, making it accessible to people in the firm who need this information (e.g., marketing, operations).

A growing number of products are being designed in this way, including transformers, automobile parts, aircraft parts, integrated circuits, and electric motors.

A major benefit of CAD is the increased productivity of designers. No longer is it necessary to laboriously prepare mechanical drawings of products or parts and revise them repeatedly to correct errors or incorporate revisions. A rough estimate is that CAD increases the productivity of designers from 3 to 10 times. A second major benefit of CAD is the creation of a database for manufacturing that can supply needed information on product geometry and dimensions, tolerances, material specifications, and so on. It should be noted, however, that CAD needs this database to function and that this entails a considerable amount of effort.

An architect is using an iPad CAD (computer-aided design) application to model a 3D layout design of a new house.



Iain Masterton/Alamy Stock Photo

Some CAD systems allow the designer to perform engineering and cost analyses on proposed designs. For instance, the computer can determine the weight and volume of a part and do stress analysis as well. When there are a number of alternative designs, the computer can quickly go through the possibilities and identify the best one, given the designer's criteria. CAD that includes finite element analysis (FEA) capability can greatly shorten the time to market of new products. It enables developers to perform simulations that aid in the design, analysis, and commercialization of new products. Designers in industries such as aeronautics, biomechanics, and automobiles use FEA.

Production Requirements

As noted earlier in the chapter, designers must take into account *production capabilities*. Design needs to clearly understand the capabilities of production (e.g., equipment, skills, types of materials, schedules, technologies, special abilities). This helps in choosing designs that match capabilities. When opportunities and capabilities do not match, management must consider the potential for expanding or changing capabilities to take advantage of those opportunities.

Forecasts of future demand can be very useful, supplying information on the timing and volume of demand, and information on demands for new products and services.

Manufacturability is a key concern for manufactured goods: Ease of fabrication and/or assembly is important for cost, productivity, and quality. With services, ease of providing the service, cost, productivity, and quality are of great concern.

The term **design for manufacturing (DFM)** is used to indicate the designing of products that are compatible with an organization's capabilities. A related concept in manufacturing is **design for assembly (DFA)**. A good design must take into account not only how a product will be fabricated, but also how it will be assembled. Design for assembly focuses on reducing the number of parts in an assembly, as well as on the assembly methods and sequence that will be employed. Another, more general term, **manufacturability**, is sometimes used when referring to the ease with which products can be fabricated and/or assembled.

Component Commonality

Companies often have multiple products or services to offer customers. Often, these products or services have a high degree of similarity of features and components. This is particularly true of *product families*, but it is also true of many services. Companies can realize significant benefits when a part can be used in multiple products. For example, car manufacturers employ this tactic by using internal components such as water pumps, engines, and transmissions on several automobile nameplates. In addition to the savings in design time, companies reap benefits through standard training for assembly and installation, increased opportunities for savings by buying in bulk from suppliers, and commonality of parts for repair, which reduces the inventory that dealers and auto parts stores must carry. Similar benefits accrue in services. For example, in automobile repair, component commonality means less training is needed because the variety of jobs is reduced. The same applies to appliance repair, where commonality and *substitutability* of parts are typical. Multiple-use forms in financial and medical services are other examples. Computer software often comprises a number of modules that are commonly used for similar applications, thereby saving the time and cost to write the code for major portions of the software. Tool manufacturers use a design that allows tool users to attach different power tools to a common power source. Similarly, HP has a universal power source that can be used with a variety of computer hardware.

Design for manufacturing (DFM) The designing of products that are compatible with an organization's capabilities.

Design for assembly (DFA) Design that focuses on reducing the number of parts in a product and on assembly methods and sequence.

Manufacturability The capability of an organization to produce an item at an acceptable profit.

4.11 SERVICE DESIGN

There are many similarities between product and service design. However, there are some important differences as well, owing to the nature of services. One major difference is that unlike manufacturing, where production and delivery are usually separated in time, services are usually created and delivered *simultaneously*.

Service Something that is done to or for a customer.

Service delivery system The facilities, processes, and skills needed to provide a service.

Product bundle The combination of goods and services provided to a customer.

Service package The physical resources needed to perform the service, the accompanying goods, and the explicit and implicit services included.

LO4.11 Discuss the two key issues in service design.

Service refers to an *act*, something that is done to or for a customer (client, patient, etc.). It is provided by a **service delivery system**, which includes the facilities, processes, and skills needed to provide the service. Many services are not pure services, but part of a **product bundle**—the combination of goods and services provided to a customer. The service component in products is increasing. The ability to create and deliver reliable customer-oriented service is often a key competitive differentiator. Successful companies combine customer-oriented service with their products.

System design involves development or refinement of the overall **service package**:¹

1. The physical resources needed.
2. The accompanying goods that are purchased or consumed by the customer, or provided with the service.
3. Explicit services (the essential/core features of a service, such as tax preparation).
4. Implicit services (ancillary/extra features, such as friendliness, courtesy).

Overview of Service Design

Service design begins with the choice of a service strategy, which determines the nature and focus of the service, and the target market. This requires an assessment by top management of the potential market and profitability (or need, in the case of a nonprofit organization) of a particular service, and an assessment of the organization's ability to provide the service. Once decisions on the focus of the service and the target market have been made, the customer requirements and expectations of the target market must be determined.

Two key issues in service design are the degree of variation in service requirements and the degree of customer contact and customer involvement in the delivery system. These have an impact on the degree to which service can be standardized or must be customized. The lower the degree of customer contact and service requirement variability, the more standardized the service can be. Service design with no contact and little or no processing variability is very much like product design. Conversely, high variability and high customer contact generally mean the service must be highly customized. A related consideration in service design is the opportunity for selling: The greater the degree of customer contact, the greater the opportunities for selling.

Differences between Service Design and Product Design

Service operations managers must contend with issues that may be insignificant or nonexistent for managers in a production setting. These include the following:

1. Products are generally tangible; services are generally intangible. Consequently, service design often focuses more on intangible factors (e.g., peace of mind, ambiance) than does product design.
2. In many instances, services are created and delivered at the same time (e.g., a haircut, a car wash). In such instances, there is less latitude in finding and correcting errors *before* the customer has a chance to discover them. Consequently, training, process design, and customer relations are particularly important.
3. Services cannot be inventoried. This poses restrictions on flexibility and makes capacity issues very important.
4. Services that are highly visible to consumers and must be designed with that in mind; this adds an extra dimension to process design, one that usually is not present in product design.
5. Some services have low barriers to entry and exit. This places additional pressures on service design to be innovative and cost-effective.
6. Location is often important to service design, with convenience as a major factor. Hence, design of services and choice of location are often closely linked.

¹Adapted from James A. Fitzsimmons and Mona J. Fitzsimmons, *Service Management for Competitive Advantage* (New York: McGraw-Hill, 1994). McGraw-Hill Companies, Inc., 1994.

7. Service systems range from those with little or no customer contact to those that have a very high degree of customer contact. Here are some examples of those different types:
 - Insulated technical core; little or no customer contact (e.g., software development)
 - Production line; little or no customer contact (e.g., automatic car wash)
 - Personalized service (e.g., haircut, medical service)
 - Consumer participation (e.g., diet program, dance lessons)
 - Self-service (e.g., supermarket)
 If there is little or no customer contact, service system design is like product system design.
8. Demand variability alternately creates customer waiting times, which sometimes leads to lost sales, or idle service resources.

When demand variability is a factor, designers may approach service design from one of two perspectives. One is a cost and efficiency perspective, and the other is a customer perspective. Waiting line analysis (see Chapter 18) can be especially useful in this regard.

Basing design objectives on cost and efficiency is essentially a “product design approach” to service design. Because customer participation makes both quality and demand variability more difficult to manage, designers may opt to limit customer participation in the process where possible. Alternatively, designers may use staff flexibility as a means of dealing with demand variability.

In services, a significant aspect of perceived quality relates to the intangibles that are part of the service package. Designers must proceed with caution because attempts to achieve a high level of efficiency tend to depersonalize service and to create the risk of negatively altering the customer’s perception of quality. Such attempts may involve the following:

- Reducing consumer choices makes service more efficient, but it can be both frustrating and irritating for the customer. An example would be a cable company that bundles channels, rather than allowing customers to pick only the channels they want.
- Standardizing or simplifying certain elements of service can reduce the cost of providing a service, but it risks eliminating features that some customers value, such as personal attention.
- Incorporating flexibility in capacity management by employing part-time or temporary staff may involve the use of less-skilled or less-interested people, and service quality may suffer.

Design objectives based on customer perspective require understanding the customer experience, and focusing on how to maintain control over service delivery to achieve customer satisfaction. The customer-oriented approach involves determining consumer wants and needs in order to understand relationships between service delivery and perceived quality. This enables designers to make enlightened choices in designing the delivery system.

Of course, designers must keep in mind that while depersonalizing service delivery for the sake of efficiency can negatively impact perceived quality, customers may not want or be willing to pay for highly personalized service either, so trade-offs may have to be made.

Phases in the Service Design Process

Table 4.5 lists the phases in the service design process. As you can see, they are quite similar to the phases of product design, except that the delivery system also must be designed.

1. Conceptualize.
 - Idea generation
 - Assessment of customer wants/needs (marketing)
 - Assessment of demand potential (marketing)
2. Identify service package components needed (operations and marketing).
3. Determine performance specifications (operations and marketing).
4. Translate performance specifications into design specifications.
5. Translate design specifications into delivery specifications.

TABLE 4.5

Phases in service design process

FIGURE 4.7 A simple service blueprint for a restaurant

Customer actions	Arrive	Seated	Order	Eat	Pay and leave		
line of information							
Contact persons	Greeted by hostess Hostess checks reservation Hostess escorts customers to their table	Greeted by server Server provides menus Server fills water glasses	Server describes specials Server takes orders	Dinners are served	Server occasionally checks to see if any problems	Server brings the check Server receives payment	Busboy clears table
line of visibility							
Backstage contacts			Kitchen staff prepares food			Dishes are washed	
line of internal interaction							
Support	Reservation system		Ordering food		Cashier	Laundry service	

Service Blueprinting

Service blueprint A method used in service design to describe and analyze a proposed service.

A useful tool for conceptualizing a service delivery system is the **service blueprint**, which is a method for describing and analyzing a service process. A service blueprint is much like an architectural drawing, but instead of showing building dimensions and other construction features, a service blueprint shows the basic customer and service actions involved in a service operation. Figure 4.7 illustrates a simple service blueprint for a restaurant. At the top of the figure are the customer actions, and just below are the related actions of the direct contact service people. Next are what are sometimes referred to as “backstage contacts”—in this example, the kitchen staff—and below those are the support, or “backroom,” operations. In this example, support operations include the reservation system, ordering of food and supplies, cashier, and the outsourcing of laundry service. Figure 4.7 is a simplified illustration—typically, time estimates for actions and operations would be included.

The major steps in service blueprinting are as follows:

1. Establish boundaries for the service and decide on the level of detail needed.
2. Identify and determine the sequence of customer and service actions and interactions. A flowchart can be a useful tool for this.
3. Develop time estimates for each phase of the process, as well as time variability.
4. Identify potential failure points and develop a plan to prevent or minimize them, as well as a plan to respond to service errors.

LO4.12 List the characteristics of well-designed service systems.

Characteristics of Well-Designed Service Systems

There are a number of characteristics of well-designed service systems. They can serve as guidelines in developing a service system. They include the following:

- Being consistent with the organization’s mission.
- Being user-friendly.
- Being robust if variability is a factor.



Services can pose a variety of managerial challenges for managers—challenges that in manufacturing are either much less or nonexistent. And because services represent an increasing share of the economy, this places added importance on understanding and dealing with the challenges of managing services. Here are some of the main factors:

- Jobs in service environments are often less structured than in manufacturing environments.
- Customer contact is usually much higher in services.
- In many services, worker skill levels are low compared to those of manufacturing workers.
- Services are adding many new workers in low-skill, entry-level positions.
- Employee turnover is often higher, especially in the low-skill jobs.
- Input variability tends to be higher in many service environments than in manufacturing.
- Service performance can be adversely affected by workers' emotions, distractions, customers' attitudes, and other factors, many of which are beyond managers' control.

Because of these factors, quality and costs are more difficult to control, productivity tends to be lower, the risk of customer dissatisfaction is greater, and employee motivation is more difficult.

Questions

1. What managerial challenges do services present that manufacturing does not?
2. Why does service management present more challenges than manufacturing?

- Being easy to sustain.
- Being cost-effective.
- Having value that is obvious to customers.
- Having effective linkages between back-of-the-house operations (i.e., no contact with the customer) and front-of-the-house operations (i.e., direct contact with customers). Front operations should focus on customer service, while back operations should focus on speed and efficiency.
- Having a single, unifying theme, such as convenience or speed.
- Having design features and checks that will ensure service that is reliable and of high quality.

Challenges of Service Design

Variability is a major concern in most aspects of business operations, and it is particularly so in the design of service systems. Requirements tend to be variable, both in terms of differences in what customers want or need, and in terms of the timing of customer requests. Because services generally cannot be stored, there is the additional challenge of balancing supply and demand. This is less of a problem for systems in which the timing of services can be scheduled (e.g., doctor's appointment), but not so in others (e.g., emergency room visit).

Another challenge is that services can be difficult to describe precisely and are dynamic in nature, especially when there is a direct encounter with the customer (e.g., personal services), due to the large number of variables.

Guidelines for Successful Service Design

1. Define the service package in detail. A service blueprint may be helpful for this.
2. Focus on the operation from the customer's perspective. Consider how customer expectations and perceptions are managed during and after the service.
3. Consider the image that the service package will present both to customers and to prospective customers.
4. Recognize that designers' familiarity with the system may give them quite a different perspective than that of the customer, and take steps to overcome this.
5. Make sure that managers are involved and will support the design once it is implemented.
6. Define quality for both tangibles and intangibles. Intangible standards are more difficult to define, but they must be addressed.

LO4.13 List some guidelines for successful service design.

7. Make sure that recruitment, training, and reward policies are consistent with service expectations.
8. Establish procedures to handle both predictable and unpredictable events.
9. Establish systems to monitor, maintain, and improve service.

4.12 OPERATIONS STRATEGY

Product and service design is a fertile area for achieving competitive advantage and/or increasing customer satisfaction. Potential sources of such benefits include the following:

- Packaging products and ancillary services to increase sales. Examples include selling laptops at a reduced cost with a two-year internet access sign-up agreement, offering extended warranties on products, offering installation and service, and offering training with computer software.
- Using multiple-use platforms. Auto manufacturers use the same platform (basic chassis, say) for several nameplates (e.g., Jaguar S type, Lincoln LS, and Ford Thunderbird have shared the same platform). There are two basic computer platforms, PC and Mac, with many variations of computers using a particular platform.
- Implementing tactics that will achieve the benefits of high volume while satisfying customer needs for variety, such as mass customization.
- Continually monitoring products and services for small improvements rather than the “big bang” approach. Often, the “little” things can have a positive, long-lasting effect on consumer attitudes and buying behavior.
- Shortening the time it takes to get new or redesigned goods and services to market.

A key competitive advantage of some companies is their ability to bring new products to market more quickly than their competitors. Companies using this “first-to-market” approach are able to enter markets ahead of their competitors, allowing them to set higher selling prices than otherwise due to absence of competition. Such a strategy is also a defense against competition from cheaper “clones” because the competitors always have to play “catch up.”

From a design standpoint, reducing the time to market involves:

- Using standardized components to create new but reliable products.
- Using technology such as computer-aided design (CAD) equipment to rapidly design new or modified products.
- Concurrent engineering to shorten engineering time.

SUMMARY

Product and service design is a key factor in satisfying the customer. To be successful in product and service design, organizations must be continually aware of what customers want, what the competition is doing, what government regulations are, and what new technologies are available.

The design process involves motivation, ideas for improvement, organizational capabilities, and forecasting. In addition to product life cycles, legal, environmental, and ethical considerations influence design choices. What degree of standardization designers should incorporate into designs is also an important consideration. A key objective for designers is to achieve a product or service design that will meet or exceed customer expectations, within cost or budget and taking into account the capabilities of operations. Although product design and service design are similar in some respects, a number of key differences exist between products and services that influence the way they are designed.

Successful design often incorporates many of these basic principles: Determine what customers want as a starting point; minimize the number of parts needed to manufacture an item or the number of steps to provide a service; simplify assembly or service, standardize as much as possible; and make the design robust. Trade-off decisions are common in design, and they involve such things as

development time and cost, product or service cost, special features/performance, and product or service complexity.

Research and development efforts can play a significant role in product and process innovations, although these are sometimes so costly that only large companies or governments can afford to underwrite them.

Reliability of a product or service is often a key dimension in the eyes of the customer. Measuring and improving reliability are important aspects of product and service design, although other areas of the organization also have an influence on reliability.

Quality function deployment is one approach for getting customer input for product or service design.

1. A range of factors can cause an organization to design or redesign a product or service, including economic, legal, political, social, technological, and competitive pressures. Furthermore, an important cause of operations failures can be traced to faulty design.
2. Every area of a business organization and its supply chain is connected to, and influenced by, its products and/or services, so the potential impact on each area must be taken into account when products or services are redesigned or new products or services are to be designed.
3. Central issues relate to the actual or expected demand for a product or service, the organization's capabilities, the cost to produce or provide, the desired quality level, and the cost and availability of necessary resources.
4. Among considerations that are generally important are legal, ethical, and environmental.
5. Although there are some basic differences between product design and service design, there are many similarities between the two.

computer-aided design (CAD), 164	mass customization, 154	research and development (R&D), 143
concurrent engineering, 163	modular design, 155	reverse engineering, 142
cradle-to-grave assessment, 146	normal operating conditions, 156	robust design, 157
delayed differentiation, 154	product bundle, 166	service, 166
design for assembly (DFA), 165	product liability, 144	serviceability, 141
design for disassembly (DFD), 149	product life cycle management (PLM), 153	service blueprint, 168
design for manufacturing (DFM), 165	quality function deployment (QFD), 158	service delivery system, 166
design for recycling (DFR), 149	recycling, 149	service package, 166
failure, 156	reliability, 156	standardization, 153
manufacturability, 141, 165	remanufacturing, 148	Uniform Commercial Code, 144
		value analysis, 147

1. What are some of the factors that cause organizations to redesign their products or services?
2. Contrast applied research with basic research.
3. What is CAD? Describe some of the ways a product designer can use it.
4. Name some of the main advantages and disadvantages of standardization.
5. What is modular design? What are its main advantages and disadvantages?
6. Explain the term *design for manufacturing* and briefly explain why it is important.
7. What are some of the competitive advantages of concurrent engineering?
8. Explain the term *remanufacturing*.
9.
 - a. What is meant by the term *life cycle*?
 - b. Why would this be a consideration in product or service design?
 - c. Name three ways that each of these products has found new uses: baking soda, duct tape, and vinegar.
10. Why is R&D a key factor in productivity improvement? Name some ways R&D contributes to productivity improvements.
11. What is *mass customization*?
12. Name two factors that could make service design much different from product design.

KEY POINTS

KEY TERMS

DISCUSSION AND REVIEW QUESTIONS

13. Explain the term *robust design*.
14. Explain what *quality function deployment* is and how it can be useful.
15. What is reverse engineering? Do you feel this is unethical?
16. What is the purpose of value analysis?
17. What is life cycle assessment, and what is its overall goal?
18. Explain the term “three Rs” and how the three Rs relate to sustainability.
19. a. Select an electronic device you are familiar with. What standard feature does it have that was once a “wow” feature? What “wow” feature does it have that you think will soon be a standard feature on new versions?
b. Answer part *a* for a service you are familiar with.

TAKING STOCK

1. Describe some of the trade-offs that are encountered in product and service design.
2. Who needs to be involved in the design of products and services?
3. How has technology had an impact on product and service design?

CRITICAL THINKING EXERCISES

1. A number of fast-food chains, after their success with offering their customers fresh salads, and in an effort to downplay the image of selling unhealthy food, began adding fresh fruit plates to their menus. At about the same time, and seemingly in direct conflict with this “healthy” strategy, several other fast-food chains began offering fat- and calorie-laden items to their menus. Compare these two widely different approaches, and predict the chances of each one’s success. Name some other products that are popular, despite known health risks.
2. In wintry conditions, highway safety is improved by treating road surfaces with substances that will provide traction and/or melt snow and ice. Sand and rock salt are two widely used substances. Recently, a combination of beet juice and rock salt is being used in some parts of the country to treat road surfaces. Suppose you have been asked to provide a list of factors to consider for a switch from rock salt alone to using a combination of beet juice and rock salt. Name the major considerations you would take into account in making a decision in the following categories: cost considerations, environmental considerations, both positive and negative, and other considerations.
3. How were food producers impacted by the U.S. government’s requirement to identify the trans fat content on product labels?
4. Suppose a company intends to offer a new service to some of its internal customers. Briefly discuss how the fact that the customers are internal would change the process of managing the four phases of the service life cycle.
5. A few days before the end of the term of a two-year NDA (nondisclosure agreement) he signed with a start-up company related to a possible patent, Frank interviewed with another start-up and divulged information covered by the agreement. The interview had been scheduled for a week later, in which case it wouldn’t have been an issue, but had been moved up when another job applicant dropped out and the company had an opening for an earlier interview. Frank reasoned that he had met the spirit of the NDA, and a few days early wouldn’t really matter. Besides, as it turned out, the company he interviewed with wasn’t interested in that information, although they did hire him. What would you have done if you were Frank?
6. Give two examples of unethical conduct involving product or service design and the ethical principles (see Chapter 1) that are violated.

PROBLEMS

1. Examine and compare one of the following product sets. Base your comparison on such factors as features, costs, convenience, ease of use, and value.
 - a. GPS versus maps
 - b. Cell phones versus landlines
 - c. Online shopping versus “bricks and mortar” shopping
 - d. Standard gasoline automobile engines versus hybrids
 - e. Online course versus classroom
 - f. Satellite television versus cable

2. Use the internet to obtain recent crash-safety ratings for passenger vehicles. Then, answer these questions:
 - a. Which vehicles received the highest ratings? The lowest ratings?
 - b. How important are crash-safety ratings to new car buyers? Does the degree of importance depend on the circumstances of the buyer?
 - c. Which types of buyers would you expect to be the most concerned with crash-safety ratings?
 - d. Are there other features of a new car that might sway a buyer from focusing solely on crash safety? If so, what might they be?
3. Prepare a service blueprint for each of these banking transactions:
 - a. Make a savings deposit using a teller
 - b. Apply for a home equity loan
4. Prepare a service blueprint for each of these post office transactions:
 - a. Buy stamps from a machine
 - b. Buy stamps from a postal clerk
5. List the steps involved in getting gasoline into your car for full service and for self-service. Assume that paying cash is the only means of payment. For each list, identify the potential trouble points and indicate a likely problem.
6. Construct a list of steps for making a cash withdrawal from an automated teller machine (ATM). Assume that the process begins at the ATM with your bank card in hand. Then, identify the potential failure points (i.e., where problems might arise in the process). For each failure point, state one potential problem.
7.
 - a. Refer to Figure 4.4. What two technical requirements have the highest impact on the customer requirement that the paper not tear?
 - b. The following table presents technical requirements and customer requirements for the output of a laser printer. First, decide if any of the technical requirements relate to each customer requirement. Decide which technical requirement, if any, has the greatest impact on that customer requirement.

TECHNICAL REQUIREMENTS

Customer Requirements	Type of Paper	Internal Paper Feed	Print Element
Paper doesn't wrinkle			
Prints clearly			
Easy to use			

8. Prepare a table similar to that shown in problem 7b for cookies sold in a bakery. List what you believe are the three most important customer requirements (not including cost) and the three most relevant technical requirements (not including sanitary conditions). Next, indicate using a check-mark which customer requirements and which technical requirements are related.



The High Acres Landfill is located on a 218-acre site outside Fairport, New York. Opened in 1971, it is licensed to handle residential, commercial, and industrial nonhazardous waste. The landfill has 27 employees, and it receives approximately 3,000 tons of waste per day.

The public often has certain preconceived notions about a landfill, chief among them that landfills are dirty and unpleasant. However, a visit to the landfill by citizens dispelled some of those misconceptions. The entrance is nicely landscaped, and most of the site is planted with grass and a few trees. Although unpleasant odors can emanate from arriving trucks or at the dump site, the remainder of the landfill is relatively free of noxious smells.

A major portion of the landfill consists of a large hill, within which the waste is buried. Initially, the landfill began not as a hill but as a large hole in the ground. After a number of years of depositing waste, the hole eventually was filled. From that point on, as additional layers were added, the landfill began to take the shape of a flattop hill. Each layer was a little narrower than the preceding one, giving the hill a slope. The sides of the hill were planted with grass, and only the “working face” along the top currently remains unplanted. When the designated capacity

is exhausted (this may take another 10 years), the landfill will be closed to further waste disposal. The site will be converted into a public park with hiking trails and picnic and recreation areas, and then given to the town.

The construction and operation of landfills are subject to numerous state and federal regulations. For example, nonpermeable liners must be placed on the bottom and sides of the landfill to prevent leakage of liquids into the groundwater. (Independent firms monitor groundwater to determine if there is any leakage into wells placed around the perimeter of the hill.) Mindful of public opinion, every effort is made to minimize the amount of time that waste is left exposed. At the end of each day, the waste that has been deposited in the landfill is compacted and covered with six inches of soil.

The primary source of income for the landfill is the fees it charges users. The landfill also generates income from methane gas, a by-product of organic waste decomposition, that accumulates within the landfill. A collection system is in place to capture and extract the gas from the landfill, and it is then sold to the local power company. Also, the landfill has a composting operation in which leaves and other yard wastes are converted into mulch.

SELECTED BIBLIOGRAPHY AND FURTHER READINGS

Davis, Mark M., and Janelle Heineke. *Managing Services: Using Technology to Create Value*. New York: McGraw-Hill/Irwin, 2003.

Fitzsimmons, James A., and Mona J. Fitzsimmons. *Service Management: Operations, Strategy, and Information Technology*, 7th ed. New York: McGraw-Hill, 2011.

Gilmore, James, and B. Joseph Pine II. *Markets of One: Creating Customer-Unique Value through Mass Customization*. Boston: Harvard Business School Press, 2000.

Gorman, Michael E. *Transforming Nature: Ethics, Invention, and Design*. Boston: Kluwer Academic Publishers, 1998.

Groover, Mikell P. *Automation, Production Systems, and Computer-Aided Manufacturing*, 3rd ed. Englewood Cliffs, NJ: Prentice Hall, 2008.

Lovelock, Christopher H. *Services Marketing: People, Technology, Strategy*, 3rd ed. Englewood Cliffs, NJ: Prentice Hall, 2010.

Ulrich, Karl T., and Steven D. Eppinger. *Product Design and Development*, 3rd ed. New York: McGraw-Hill, 2004.

Vicente, Kim. *The Human Factor*. New York: Routledge, 2004.

4

Reliability

SUPPLEMENT

LEARNING OBJECTIVES

After completing this supplement, you should be able to:

- LO4S.1** Define *reliability*
- LO4S.2** Perform simple reliability computations.
- LO4S.3** Explain the term *availability* and perform simple calculations.

SUPPLEMENT OUTLINE

- CHAPTER 4S.1 Introduction** 176
- CHAPTER 4S.2 Quantifying Reliability** 176
 - Finding the Probability of Functioning When Activated 177
 - Finding the Probability of Functioning for a Specified Length of Time 178
- CHAPTER 4S.3 Availability** 183

LO4S.1 Define *reliability*.

Reliability The ability of a product, part, or system to perform its intended function under a prescribed set of conditions.

4S.1 INTRODUCTION

Reliability is a measure of the ability of a product, service, part, or system to perform its intended function under a prescribed set of conditions, and often over a designated time interval or life span. In effect, reliability is a *probability*.

Suppose that an item has a reliability of .90. This means it has a 90 percent probability of functioning as intended, either when needed (e.g., a security warning system) or over its life span (e.g., a vehicle). The probability it will fail is $1 - .90 = .10$, or 10 percent. Hence, it is expected that, on average, 1 in every 10 such items will fail or, equivalently, that the item will fail, on average, once in every 10 trials. Similarly, a reliability of .985 implies 15 failures per 1,000 parts or trials.

4S.2 QUANTIFYING RELIABILITY

Engineers and designers have a number of techniques at their disposal for assessing reliability. A discussion of those techniques is not within the scope of this text. Instead, let us turn to the issue of quantifying overall product or system reliability. Probability is used in two ways:

1. The probability that the product or system will function when activated.
2. The probability that the product or system will function for a given length of time.

The first of these focuses on *one point in time* and is often used when a system must operate for one time or a relatively few number of times. The second of these focuses on the *length of service*. The distinction will become more apparent as each of these approaches is described in more detail.

Finding the Probability of Functioning When Activated

LO4S.2 Perform simple reliability computations.

The probability that a system or a product will operate as planned is an important concept in system and product design. Determining that probability when the product or system consists of a number of *independent* components requires the use of the rules of probability for independent events. **Independent events** have no relation to the occurrence or nonoccurrence of each other. What follows are three examples illustrating the use of probability rules to determine whether a given system will operate successfully.

Independent events Events whose occurrence or nonoccurrence does not influence each other.

Rule 1. If two or more events are independent and *success* is defined as the probability that all of the events occur, then the probability of success is equal to the product of the probabilities of the events.

Example Suppose a room has two lamps, but to have adequate light both lamps must work (success) when turned on. One lamp has a probability of working of .90, and the other has a probability of working of .80. The probability that both will work is $.90 \times .80 = .72$. Note that the order of multiplication is unimportant: $.80 \times .90 = .72$. Also note that if the room had three lamps, three probabilities would have been multiplied.

This system can be represented by the following diagram:



Even though the individual components of a system might have high reliabilities, the system as a whole can have considerably less reliability because all components that are in series (as are the ones in the preceding example) must function. As the number of components in a series increases, the system reliability decreases. For example, a system that has eight components in a series, each with a reliability of .99, has a reliability of only $.99^8 = .923$.

Obviously, many products and systems have a large number of component parts that must all operate, and some way to increase overall reliability is needed. One approach is to use **redundancy** in the design. This involves providing backup parts for some items.

Redundancy The use of backup components to increase reliability.

Rule 2. If two events are independent and *success* is defined as the probability that *at least one* of the events will occur, the probability of success is equal to the probability of either one plus 1.00 minus that probability multiplied by the other probability.

Example There are two lamps in a room. When turned on, one has a probability of working of .90 and the other has a probability of working of .80. Only a single lamp is needed to light for success. If one fails to light when turned on, the other lamp is turned on. Hence, one of the lamps is a backup in case the other one fails. Either lamp can be treated as the backup; the probability of success will be the same. The probability of success is $.90 + (1 - .90) \times .80 = .98$. If the .80 light is first, the computation would be $.80 + (1 - .80) \times .90 = .98$.

This system can be represented by the following diagram:

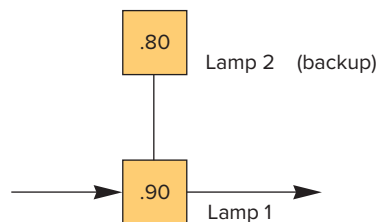

Rule 3. If two or more events are involved and success is defined as the probability that at least one of them occurs, the probability of success is $1 - p$ (all fail).

Example Three lamps have probabilities of .90, .80, and .70 of lighting when turned on. Only one lighted lamp is needed for success; hence, two of the lamps are considered to be backups. The probability of success is

$$1 - [(1 - .90) \times (1 - .80) \times (1 - .70)] = .994$$

Note: It is assumed that the switch that activates each lamp has a reliability of 100%. To see how to incorporate a switch with less than 100% reliability, consider that the second “lamp” is actually a switch with a probability of operating equal to .80, and the third lamp is the only backup (i.e., the second lamp). Thus, the problem would be solved in exactly the same way.

This system can be represented by the following diagram:

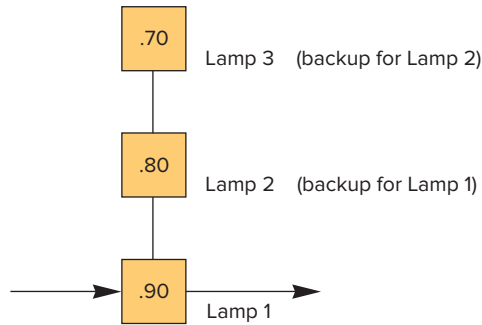

EXAMPLE 4S-1

Computing Reliability

Determine the reliability of the following system.

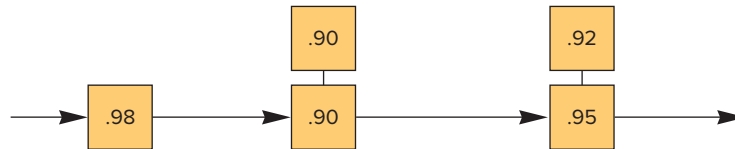

SOLUTION

The system can be reduced to a series of three components:

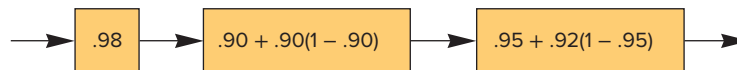

The system reliability is, then, the product of these:

$$.98 \times .99 \times .996 = .966$$

Finding the Probability of Functioning for a Specified Length of Time

The second way of looking at reliability considers the incorporation of a time dimension: Probabilities are determined relative to a specified length of time. This approach is commonly used in product warranties, which pertain to a given period of time after purchase of a product.

A typical profile of product failure rate over time is illustrated in Figure 4S.1. Because of its shape, it is sometimes referred to as a bathtub curve. Frequently, a number of products fail shortly after they are put into service, not because they wear out, but because they are defective to begin with. The rate of failures decreases rapidly once the truly defective items are weeded out. During the second phase, there are fewer failures because most of the defective items have been eliminated, and it is too soon to encounter items that fail because they have worn out. In some cases, this phase covers a relatively long time. In the third phase, failures occur because the products are worn out, and the failure rate increases.

Information on the distribution and length of each phase requires the collection of historical data and analysis of those data. It often turns out that the **mean time between failures (MTBF)**

LO4S.2 Perform simple reliability computations.

Mean time between failures (MTBF) The average length of time between failures of a product or component.

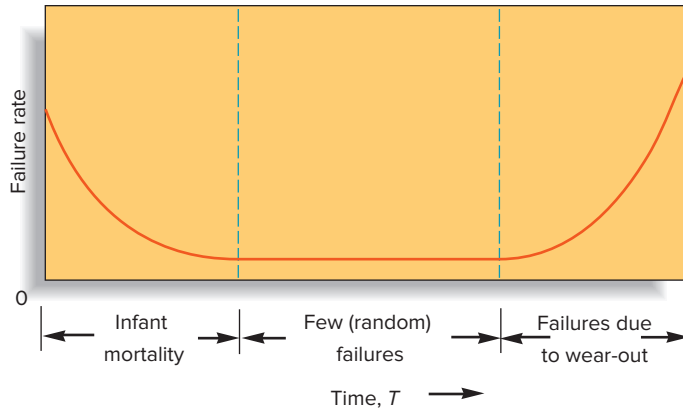

FIGURE 4S.1
Failure rate is a function of time

in the infant mortality phase can be modeled by a negative exponential distribution, such as that depicted in Figure 4S.2. Equipment failures, as well as product failures, may occur in this pattern. In such cases, the exponential distribution can be used to determine various probabilities of interest. The probability that equipment or a product put into service at time 0 will fail *before* some specified time, T , is equal to the area under the curve between 0 and T . Reliability is specified as the probability that a product will last *at least until* time T ; reliability is equal to the area under the curve *beyond* T . (Note that the total area under the curve in each phase is treated as 100 percent for computational purposes.) Observe that, as the specified length of service increases, the area under the curve to the right of that point (i.e., the reliability) decreases.

Determining values for the area under a curve to the right of a given point, T , becomes a relatively simple matter using a table of exponential values. An exponential distribution is completely described using a single parameter, the distribution mean, which reliability engineers often refer to as the mean time between failures. Using the symbol T to represent length of service, the probability that failure will *not* occur before time T (i.e., the area in the right tail) is easily determined:

$$P(\text{no failure before } T) = e^{-T/\text{MTBF}}$$

where

$$e = 2.7183 \dots$$

T = Length of service before failure

MTBF = Mean time between failures

The probability that failure will occur before time T is:

$$P(\text{failure before } T) = 1 - e^{-T/\text{MTBF}}$$

Selected values of $e^{-T/\text{MTBF}}$ are listed in Table 4S.1.

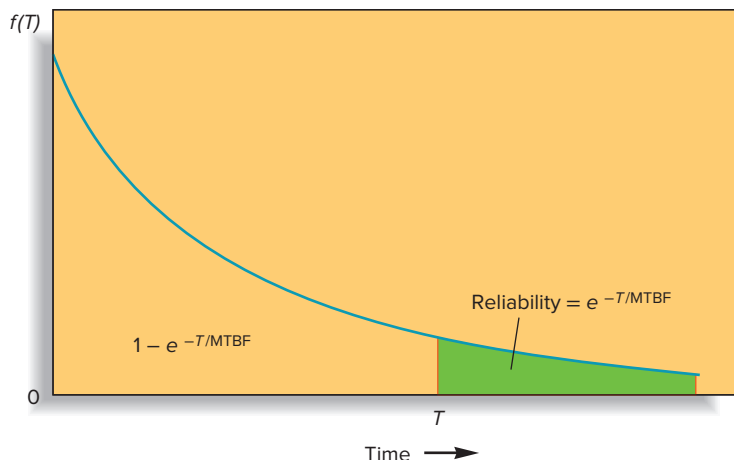

FIGURE 4S.2
An exponential distribution

TABLE 4S.1
Values of $e^{-T/\text{MTBF}}$

T/MTBF	$e^{-T/\text{MTBF}}$	T/MTBF	$e^{-T/\text{MTBF}}$	T/MTBF	$e^{-T/\text{MTBF}}$
0.10	.9048	2.60	.0743	5.10	.0061
0.20	.8187	2.70	.0672	5.20	.0055
0.30	.7408	2.80	.0608	5.30	.0050
0.40	.6703	2.90	.0550	5.40	.0045
0.50	.6065	3.00	.0498	5.50	.0041
0.60	.5488	3.10	.0450	5.60	.0037
0.70	.4966	3.20	.0408	5.70	.0033
0.80	.4493	3.30	.0369	5.80	.0030
0.90	.4066	3.40	.0334	5.90	.0027
1.00	.3679	3.50	.0302	6.00	.0025
1.10	.3329	3.60	.0273	6.10	.0022
1.20	.3012	3.70	.0247	6.20	.0020
1.30	.2725	3.80	.0224	6.30	.0018
1.40	.2466	3.90	.0202	6.40	.0017
1.50	.2231	4.00	.0183	6.50	.0015
1.60	.2019	4.10	.0166	6.60	.0014
1.70	.1827	4.20	.0150	6.70	.0012
1.80	.1653	4.30	.0136	6.80	.0011
1.90	.1496	4.40	.0123	6.90	.0010
2.00	.1353	4.50	.0111	7.00	.0009
2.10	.1255	4.60	.0101		
2.20	.1108	4.70	.0091		
2.30	.1003	4.80	.0082		
2.40	.0907	4.90	.0074		
2.50	.0821	5.00	.0067		

EXAMPLE 4S-2**Computing Product Life Probability**

By means of extensive testing, a manufacturer has determined that its Super Sucker Vacuum Cleaner models have an expected life that is exponential, with a mean of four years. Find the probability that one of these cleaners will have a life that ends

- after the initial four years of service.
- before four years of service are completed.
- not before six years of service.

SOLUTION

MTBF = 4 years

- a. $T = 4$ years:

$$T/\text{MTBF} = \frac{4 \text{ years}}{4 \text{ years}} = 1.0$$

From Table 4S.1, $e^{-1.0} = .3679$

- b. The probability of failure before $T = 4$ years is $1 - e^{-1}$, or $1 - .3679 = .6321$.

- c. $T = 6$ years:

$$T/\text{MTBF} = \frac{6 \text{ years}}{4 \text{ years}} = 1.50$$

From Table 4S.1, $e^{-1.5} = .2231$



BY LISA SPENCER

From cars to computers to kitchen appliances, consumers are bombarded with offers for extended warranties. Are they worth the investment? According to *Consumer Reports*, the answer is usually “No” (Gauntt, 2019). Then why do people buy them?

Some buy for the peace of mind of knowing that if something goes wrong during the warranty period, they are covered and won’t experience additional out-of-pocket costs. Others don’t want to worry about figuring out where to take the product for a repair, or they like knowing that it will be replaced if it can’t be fixed. Still others recall events in the past when they did not have an extended warranty and wished they did.

What factors do people weigh when making the decision to buy or not to buy? Reasons include:

The cost of the item itself. If it’s a big ticket item and expensive to replace, the extended warranty becomes more attractive. A car, for instance, may seem more important to protect than an inexpensive printer.

Past history with a similar product or the particular brand being purchased. If a person had good luck in the past with a certain brand, he may figure the warranty is unnecessary. Conversely, a bad experience with the product type or brand may make someone more likely to buy the warranty (or perhaps simply choose a different brand!).

Who will be using the product or how heavily it will be used. If the product will be used by children versus adults, or if a person tends to be rough on things, the warranty may seem more worthwhile.

The reputation of the warranty company. If a company has a good customer service record, customers may be more likely to buy the warranty. Apple Care, for instance, tends to be highly rated and is often purchased.

What the warranty will cover. Some warranties are very extensive, while others are limited by a lot of fine print. Warranties that offer a lot of protection may entice someone to purchase. Conversely, policies that have many coverage limitations or require routine maintenance to avoid nullifying the warranty may seem less desirable.

The length of the regular warranty. If the customer feels that the regular warranty is generous, or if the product type tends to have a long life, the extended warranty may seem less important.

How long the user plans to keep the product and how long the product life cycle is. If a user plans to keep the product, for instance a phone, for a short period of time, the normal warranty may already be long enough. Similarly, if the technology of the product becomes quickly obsolete, the customer may prefer upgrading to a newer model over opting for a repair.

Is the extended warranty a “good buy”?

Extended warranties can be very expensive, and some experts suggest the consumer is better off putting the cost of the

warranty into a savings account where it is available if needed (Gauntt, 2019). Additionally, many credit card companies offer extended warranty protection if the purchase is made on that account, which is a simple and free way to avoid paying for extra coverage for some types of products.

The odds of actually needing the warranty are slim; thus, they are huge money makers for the companies that sell them. This is mainly because the extended warranty covers the product during its normal useful life, when most of the products should still be functioning properly. Dave Ramsey, a personal finance guru and popular public speaker states, “Extended warranties are a really horrible set of mathematics, and the reason people sell them is because they make a bundle on them in commissions” (*Consumer Reports*, 2018).

Many appliances, for instance, last so long that the extended warranty will expire long before they will. The typical refrigerator lasts 14 to 27 years, and even a microwave oven can last seven to nine years. “Most of the things we buy today are reliable: They come with warranties that protect us and last the amount of time we expect them to,” explains Richard M. Alderman, head of the Consumer Law Center of the University of Houston (Williams, 2018).

Of course, if a person happens to get one of the few products that does fail during the time of the extended warranty, having an extended warranty would be a good thing. However, most extended warranty purchasers will not need the service, similar to how most people who purchase term life insurance do not end up needing the coverage. A *Consumer Reports* member survey indicated that most car owners spent more on the extended warranty than the value of the services they got back in return (*Consumer Reports*, 2018).

Ultimately, each person has to decide for themselves whether the peace of mind and convenience of an extended warranty offer enough value to justify the cost.

1. How do warranties or extended warranties affect a company’s costs and reputation?
2. What strategic considerations should be taken into account when deciding how long a warranty to offer?

References:

- “Are Extended Warranties Worth It?” Joshua Gauntt, WBRC, January 2, 2019. <http://www.wbrc.com/2019/01/02/are-extended-warranties-worth-it/>
- “How Long Do Refrigerators Last? The Life Span of Kitchen Appliances.” Terri Williams, *Home Improvement*, April 9, 2018. <https://www.realtor.com/advice/home-improvement/how-long-do-refrigerators-last-kitchen-appliances-life-spans/>
- “Should You Get an Extended Warranty for Your Car?” *Consumer Reports*, December 27, 2018. <https://www.yahoo.com/news/extended-warranty-car-110009647.html>

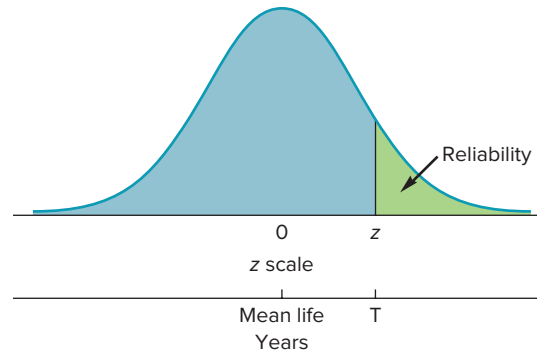

FIGURE 4S.3
A normal curve

Product failure due to wear-out can sometimes be modeled by a normal distribution. Obtaining probabilities involves the use of a table (refer to Appendix Table B.2). The table provides areas under a normal curve from (essentially) the left end of the curve to a specified point z , where z is a *standardized* value computed using the formula

$$z = \frac{T - \text{Mean wear-out time}}{\text{Standard deviation of wear-out time}}$$

Thus, to work with the normal distribution, it is necessary to know the mean of the distribution and its standard deviation. A normal distribution is illustrated in Figure 4S.3. Appendix Table B.2 contains normal probabilities (i.e., the area that lies to the left of z). To obtain a probability that service life will not exceed some value T , compute z and refer to the table. To find the reliability for time T , subtract this probability from 100 percent. To obtain the value of T that will provide a given probability, locate the nearest probability under the curve *to the left* in Appendix Table B.2. Then, use the corresponding z in the preceding formula and solve for T .

EXAMPLE 4S-3

Excel
mhhe.com/stevenson14e

Computing Life Probability and Service Life

The mean life of a certain ball bearing can be modeled using a normal distribution with a mean of six years and a standard deviation of one year. Determine each of the following:

- The probability that a ball bearing will wear out *before* seven years of service.
- The probability that a ball bearing will wear out *after* seven years of service (i.e., find its reliability).
- The service life that will provide a wear-out probability of 10 percent.

SOLUTION

Wear-out life mean = 6 years.
Wear out life standard deviation = 1 year.
Wear-out life is normally distributed.

- Compute z and use it to obtain the probability directly from Appendix Table B.2 (see diagram).

$$z = \frac{7 - 6}{1} = +1.00$$

Thus, $P(T < 7) = .8413$

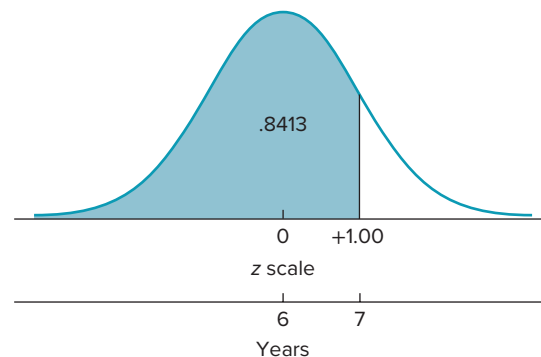

- b. Subtract the probability determined in part a from 100 percent (see diagram).

$$1.00 - .8413 = .1587$$

- c. Use the normal table and find the value of z that corresponds to an area under the curve of 10 percent (see diagram).

$$z = -1.28 = \frac{T - 6}{1}$$

Solving for T , we find $T = 4.72$ years.

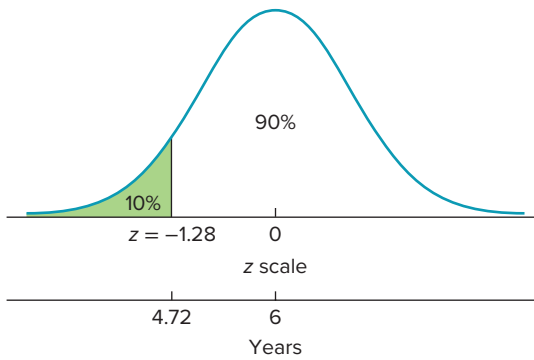
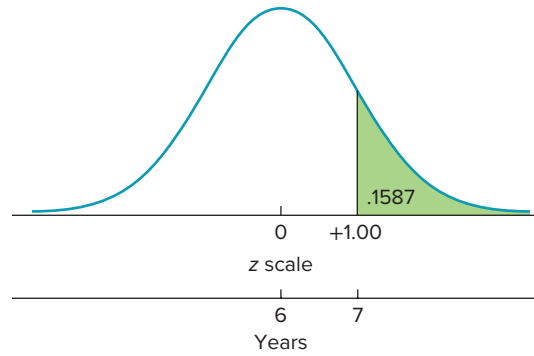

4S.3 AVAILABILITY

A related measure of importance to customers, and hence to designers, is **availability**. It measures the fraction of time a piece of equipment is expected to be operational (as opposed to being down for repairs). Availability can range from zero (never available) to 1.00 (always available). Companies that can offer equipment with a high availability factor have a competitive advantage over companies that offer equipment with lower availability values. Availability is a function of both the mean time between failures and the mean time to repair. The availability factor can be computed using the following formula:

$$\text{Availability} = \frac{\text{MTBF}}{\text{MTBF} + \text{MTR}}$$

where

MTBF = Mean time between failures

MTR = Mean time to repair, including waiting time

LO4S.3 Define the term *availability* and perform simple calculations.

Availability The fraction of time a piece of equipment is expected to be available for operation.

Computing Availability

A copier is able to operate for an average of 200 hours between repairs, and the mean repair time is 2 hours. Determine the availability of the copier.

EXAMPLE 4S-4

excel
mhhe.com/stevenson14e

SOLUTION

MTBF = 200 hours and MTR = 2 hours

$$\text{Availability} = \frac{\text{MTBF}}{\text{MTBF} + \text{MTR}} = \frac{200}{200 + 2} = .99$$

Two implications for design are revealed by the availability formula. One is that availability increases as the mean time between failures increases. The other is that availability also increases as the mean repair time decreases. It would seem obvious that designers would want to design products that have a long time between failures. However, some design options enhance repairability, which can be incorporated into the product. Ink-jet printers, for example, are designed with print cartridges that can easily be replaced.

KEY TERMS

availability, 183
independent events, 177

mean time between failures
(MTBF), 178

redundancy, 177
reliability, 176

SOLVED PROBLEMS

Problem 1 A product design engineer must decide if a redundant component is cost-justified in a certain system. The system in question has a critical component with a probability of .98 of operating. System failure would involve a cost of \$20,000. For a cost of \$100, a switch could be added that would automatically transfer the system to the backup component in the event of a failure. Should the backup be added if the backup probability is also .98?

Solution Because no probability is given for the switch, we will assume its probability of operating when needed is 100 percent. The expected cost of failure (i.e., without the backup) is $\$20,000 \times (1 - .98) = \400 .

With the backup, the probability of *not* failing would be:

$$.98 + 0.2(.98) = .9996$$

Hence, the probability of failure would be $1 - .9996 = .0004$. The expected cost of failure with the backup would be the added cost of the backup component plus the failure cost:

$$\$100 + \$20,000(.0004) = \$108$$

Because this is less than the cost without the backup, it appears that adding the backup is definitely cost justifiable.

Problem 2 Due to the extreme cost of interrupting production, a firm has two standby machines available in case a particular machine breaks down. The machine in use has a reliability of .94, and the backups have reliabilities of .90 and .80. In the event of a failure, either backup can be pressed into service. If one fails, the other backup can be used. Compute the system reliability.

Solution $R_1 = .94$, $R_2 = .90$, and $R_3 = .80$

The system can be depicted in this way:

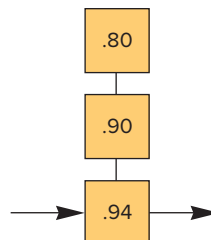

$$R_{\text{system}} = R_1 + R_2(1 - R_1) + R_3(1 - R_2)(1 - R_1)$$

$$= .94 + .90(1 - .94) + .80(1 - .90)(1 - .94) = .9988$$

A hospital has three *independent* fire alarm systems, with reliabilities of .95, .97, and .99. In the event of a fire, what is the probability that a warning would be given?

Problem 3

A warning would *not* be given if all three alarms failed. The probability that at least one alarm would operate is $1 - P$ (none operate):

Solution

$$P(\text{none operate}) = (1 - .95)(1 - .97)(1 - .99) = .000015$$

$$P(\text{warning}) = 1 - .000015 = .999985$$

A weather satellite has an expected life of 10 years from the time it is placed into earth orbit. Determine its probability of no wear-out before each of the following lengths of service. Assume the exponential distribution is appropriate.

Problem 4

- a. 5 years
- b. 12 years
- c. 20 years
- d. 30 years

MTBF is 10 years. Compute the ratio T/MTBF for $T = 5, 12, 20,$ and $30,$ and obtain the values of $e^{-T/\text{MTBF}}$ from Table 4S.1. The solutions are summarized in the following table.

Solution

T	MTBF	T/MTBF	$e^{-T/\text{MTBF}}$
a. 5	10	0.50	.6065
b. 12	10	1.20	.3012
c. 20	10	2.00	.1353
d. 30	10	3.00	.0498

What is the probability that the satellite described in Solved Problem 4 will fail between 5 and 12 years after being placed into earth orbit?

Problem 5

$$P(5 \text{ years} < \text{failure} < 12 \text{ years}) = P(\text{failure after 5 years}) - P(\text{failure after 12 years})$$

Solution

Using the probabilities shown in the previous solution, you obtain:

$$P(\text{failure after 5 years}) = .6065$$

$$-P(\text{failure after 12 years}) = .3012$$

$$\underline{\hspace{1.5cm}} .3053$$

The corresponding area under the curve is illustrated as follows.

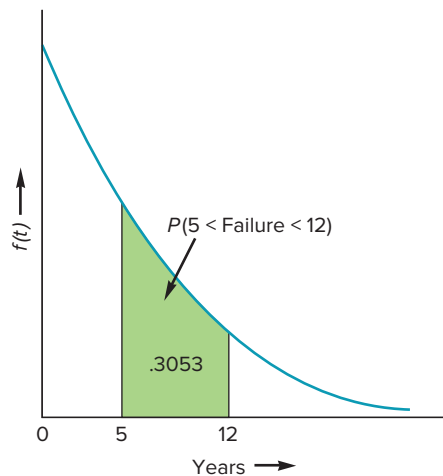

Problem 6 One line of tires produced by a large company has a wear-out life that can be modeled using a normal distribution with a mean of 25,000 miles and a standard deviation of 2,000 miles. Determine each of the following:

- The percentage of tires that can be expected to wear out within $\pm 2,000$ miles of the average (i.e., between 23,000 miles and 27,000 miles).
- The percentage of tires that can be expected to fail between 26,000 miles and 29,000 miles.
- For what tire life would you expect 4 percent of the tires to have worn out?

Solution *Notes:* (1) Miles are analogous to time and are handled in exactly the same way; (2) the term *percentage* refers to a probability.

- The phrase “within $\pm 2,000$ miles of the average” translates to within one standard deviation of the mean because the standard deviation equals 2,000 miles. Therefore, the range of z is $z = -1.00$, to $z = +1.00$, and the area under the curve between those points is found as the difference between $P(z < +1.00)$ and $P(z < -1.00)$, using values obtained from Appendix Table B.2.

$$\begin{array}{r} P(z < +1.00) = .8413 \\ -P(z < -1.00) = .1587 \\ \hline P(-1.00 < z < +1.00) = .6826 \end{array}$$

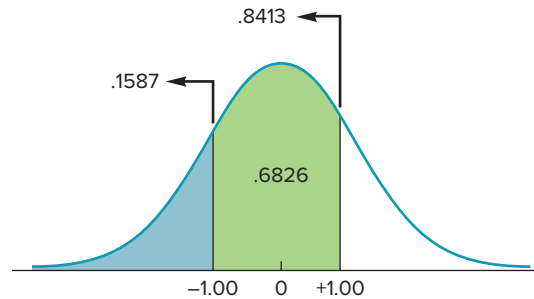

- Wear-out mean = 25,000 miles

Wear-out standard deviation = 2,000 miles

$$P(26,000 < \text{Wear-out} < 29,000) = P(z < z_{29,000}) - P(z < z_{26,000})$$

$$z_{29,000} = \frac{29,000 - 25,000}{2,000} = +2.00 \quad \text{From Appendix Table B} \quad P = .9772$$

$$z_{26,000} = \frac{26,000 - 25,000}{2,000} = +.50 \quad \text{From Appendix Table B} \quad P = .6915$$

The difference is $.9772 - .6915 = .2857$, which is the expected percent of tires that will wear out between 26,000 miles and 29,000 miles.

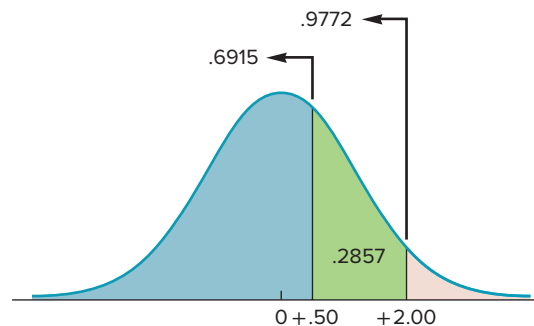

- Use Appendix Table B.1 to find z for 4 percent: $z = -1.75$.

Find tire life using $\mu + z\sigma$: $25,000 - 1.75(2,000) = 21,500$ miles.

1. Define the term *reliability*.
2. Explain why a product or system might have an overall reliability that is low even though it is comprised of components that have fairly high reliabilities.
3. What is redundancy and how can it improve product design?

DISCUSSION AND REVIEW QUESTIONS

1. Consider the following system:

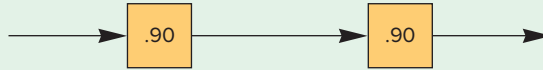

Determine the probability that the system will operate under each of these conditions:

- a. The system as shown.
 - b. Each system component has a backup with a probability of .90 and a switch that is 100 percent reliable.
 - c. Backups with .90 probability and a switch that is 99 percent reliable.
2. A product is composed of four parts. In order for the product to function properly in a given situation, each of the parts must function. Two of the parts have a .96 probability of functioning, and two have a probability of .99. What is the overall probability that the product will function properly?
 3. A system consists of three identical components. In order for the system to perform as intended, all of the components must perform. Each has the same probability of performance. If the system is to have a .92 probability of performing, what is the minimum probability of performing needed by each of the individual components?
 4. A product engineer has developed the following equation for the cost of a system component: $C = (10P)^2$, where C is the cost in dollars and P is the probability that the component will operate as expected. The system is composed of two identical components, both of which must operate for the system to operate. The engineer can spend \$173 for the two components. To the nearest two decimal places, what is the largest component probability that can be achieved?
 5. The guidance system of a ship is controlled by a computer that has three major modules. In order for the computer to function properly, all three modules must function. Two of the modules have reliabilities of .97, and the other has a reliability of .99.
 - a. What is the reliability of the computer?
 - b. A backup computer identical to the one being used will be installed to improve overall reliability. Assuming the new computer automatically functions if the main one fails, determine the resulting reliability.
 - c. If the backup computer must be activated by a switch in the event that the first computer fails, and the switch has a reliability of .98, what is the overall reliability of the system? (*Both* the switch and the backup computer must function in order for the backup to take over.)
 6. One of the industrial robots designed by a leading producer of servomechanisms has four major components. Components' reliabilities are .98, .95, .94, and .90. All of the components must function in order for the robot to operate effectively.
 - a. Compute the reliability of the robot.
 - b. Designers want to improve the reliability by adding a backup component. Due to space limitations, only one backup can be added. The backup for any component will have the same reliability as the unit for which it is the backup. Which component should get the backup in order to achieve the highest reliability?
 - c. If one backup with a reliability of .92 can be added to any one of the main components, which component should get it to obtain the highest overall reliability?
 7. A production line has three machines A, B, and C, with reliabilities of .99, .96, and .93, respectively. The machines are arranged so that if one breaks down, the others must shut down. Engineers are weighing two alternative designs for increasing the line's reliability. Plan 1 involves adding an identical backup *line*, and plan 2 involves providing a backup for each *machine*. In either case, three machines (A, B, and C) would be used with reliabilities equal to the original three.
 - a. Which plan will provide the higher reliability?
 - b. Explain why the two reliabilities are not the same.
 - c. What other factors might enter into the decision of which plan to adopt?

PROBLEMS

8. Refer to the previous problem.
 - a. Assume that the single switch used in plan 1 is 98 percent reliable, while reliabilities of the machines remain the same. Recalculate the reliability of plan 1. Compare the reliability of this plan with the reliability of plan 1 calculated in solving the original problem. How much did the reliability of plan 1 decrease as a result of a 98 percent reliable switch?
 - b. Assume that the three switches used in plan 2 are all 98 percent reliable, while reliabilities of the machines remain the same. Recalculate the reliability of plan 2. Compare the reliability of this plan with the reliability of plan 2 calculated in solving the original problem. How much did the reliability of plan 2 decrease?
9. A web server has five major components that must all function in order for it to operate as intended. Assuming that each component of the system has the same reliability, what is the minimum reliability each one must have in order for the overall system to have a reliability of .98?
10. Repeat Problem 9 using the condition that one of the components will have a backup with a reliability equal to that of any one of the other components.
11. Hoping to increase the chances of reaching a performance goal, the director of a research project has assigned three separate research teams the same task. The director estimates that the team probabilities are .9, .8, and .7 for successfully completing the task in the allotted time. Assuming that the teams work independently, what is the probability that the task will *not* be completed in time?
12. An electronic chess game has a useful life that is exponential with a mean of 30 months. Determine each of the following:
 - a. The probability that any given unit will operate for at least (1) 39 months, (2) 48 months, (3) 60 months.
 - b. The probability that any given unit will fail sooner than (1) 33 months, (2) 15 months, (3) 6 months.
 - c. The length of service time after which the percentage of failed units will approximately equal (1) 50 percent, (2) 85 percent, (3) 95 percent, (4) 99 percent.
13. A manufacturer of programmable calculators is attempting to determine a reasonable free-service period for a model it will introduce shortly. The manager of product testing has indicated that the calculators have an expected life of 30 months. Assume product life can be described by an exponential distribution.
 - a. If service contracts are offered for the expected life of the calculator, what percentage of those sold would be expected to fail during the service period?
 - b. What service period would result in a failure rate of approximately 10 percent?
14. Lucky Lumen light bulbs have an expected life that is exponentially distributed with a mean of 20,000 hours. Determine the probability that one of these light bulbs will last
 - a. at least 24,000 hours.
 - b. no longer than 4,000 hours.
 - c. between 4,000 hours and 24,000 hours.
15. Planetary Communications, Inc., intends to launch a satellite that will enhance reception of television programs in Alaska. According to its designers, the satellite will have an expected life of six years. Assume the exponential distribution applies. Determine the probability that it will function for each of the following time periods:
 - a. More than 9 years
 - b. Less than 12 years
 - c. More than 9 years but less than 12 years
 - d. At least 21 years
16. An office manager has received a report from a consultant that includes a section on equipment replacement. The report indicates that scanners have a service life that is normally distributed with a mean of 41 months and a standard deviation of 4 months. On the basis of this information, determine the percentage of scanners that can be expected to fail in the following time periods:
 - a. Before 38 months of service
 - b. Between 40 and 45 months of service
 - c. Within ± 2 months of the mean life

17. A major television manufacturer has determined that its 50-inch LED televisions have a mean service life that can be modeled by a normal distribution with a mean of six years and a standard deviation of one-half year.
 - a. What probability can you assign to service lives of at least (1) five years? (2) Six years? (3) Seven and one-half years?
 - b. If the manufacturer offers service contracts of four years on these televisions, what percentage can be expected to fail from wear-out during the service period?
 - c. What service period would achieve an expected wear-out rate of (1) 2 percent? (2) 5 percent?
18. A soon-to-be-introduced cell phone has an expected service life that can be modeled by a normal distribution with a mean of five years and a standard deviation of 0.6 year.
 - a. If the company offers a warranty of four years, what percentage of cell phones can be expected to fail before that time?
 - b. What probability can you assign to a service life of (1) 5.9 years? (2) 6.2 years?
19. Determine the availability for each of these cases:
 - a. MTBF = 40 days, average repair time = 3 days
 - b. MTBF = 300 hours, average repair time = 6 hours
20. A machine can operate for an average of 10 weeks before it needs to be overhauled, a process which takes two days. The machine is operated five days a week. Compute the availability of this machine. (*Hint*: All times must be in the same units.)
21. A manager must decide between two machines. The manager will take into account each machine's operating costs and initial costs, and its breakdown and repair times. Machine A has a projected average operating time of 142 hours and a projected average repair time of 7 hours. Projected times for machine B are an average operating time of 65 hours and a repair time of 2 hours. What are the projected availabilities of each machine?
22. A designer estimates that she can (a) increase the average time between failures of a part by 5 percent at a cost of \$450, or (b) reduce the average repair time by 10 percent at a cost of \$200. Which option would be more cost-effective? Currently, the average time between failures is 100 hours and the average repair time is 4 hours.
23. Auto batteries have an average life of 2.7 years. Battery life is normally distributed with a mean of 2.7 years and a standard deviation of .3 year. The batteries are warranted to operate for a minimum of 2 years. If a battery fails within the warranty period, it will be replaced with a new battery at no charge. The company sells and installs the batteries. Also, the usual \$5 installation charge will be waived.
 - a. What percentage of batteries would you expect to fail before the warranty period expires?
 - b. A competitor is offering a warranty of 30 months on its premium battery. The manager of this company is toying with the idea of using the same battery with a different exterior, labeling it as a premium battery, and offering a 30-month warranty on it. How much more would the company have to charge on its "premium" battery to offset the additional cost of replacing batteries?
 - c. What other factors would you take into consideration besides the price of the battery?

5

CHAPTER

Strategic Capacity Planning for Products and Services

LEARNING OBJECTIVES

After completing this chapter, you should be able to:

- LO5.1** Name the three key questions in capacity planning.
- LO5.2** Explain the importance of capacity planning.
- LO5.3** Describe ways of defining and measuring capacity.
- LO5.4** Name several determinants of effective capacity.
- LO5.5** Discuss factors to consider when deciding whether to perform in-house or outsource.
- LO5.6** Discuss the major considerations related to developing capacity alternatives.
- LO5.7** Describe the steps used to resolve constraint issues.
- LO5.8** Briefly describe approaches that are useful for evaluating capacity alternatives.

CHAPTER OUTLINE

- | | | |
|---|---|---|
| 5.1 Introduction 191 | 5.6 Forecasting Capacity Requirements 198
Calculating Processing Requirements 199 | 5.11 Evaluating Alternatives 207
Cost–Volume Analysis 208
Financial Analysis 211
Decision Theory 212
Waiting-Line Analysis 212
Simulation 212 |
| 5.2 Capacity Decisions Are Strategic 193 | 5.7 Additional Challenges of Planning Service Capacity 200 | 5.12 Operations Strategy 213
Case: Outsourcing of Hospital Services 221
Chapter Supplement: Decision Theory 222 |
| 5.3 Defining and Measuring Capacity 194 | 5.8 Do It In-House or Outsource It? 201 | |
| 5.4 Determinants of Effective Capacity 196 | 5.9 Developing Capacity Strategies 202 | |
| 5.5 Strategy Formulation 197
Steps in the Capacity Planning Process 198 | 5.10 Constraint Management 207 | |



Mark Peterson/Redux

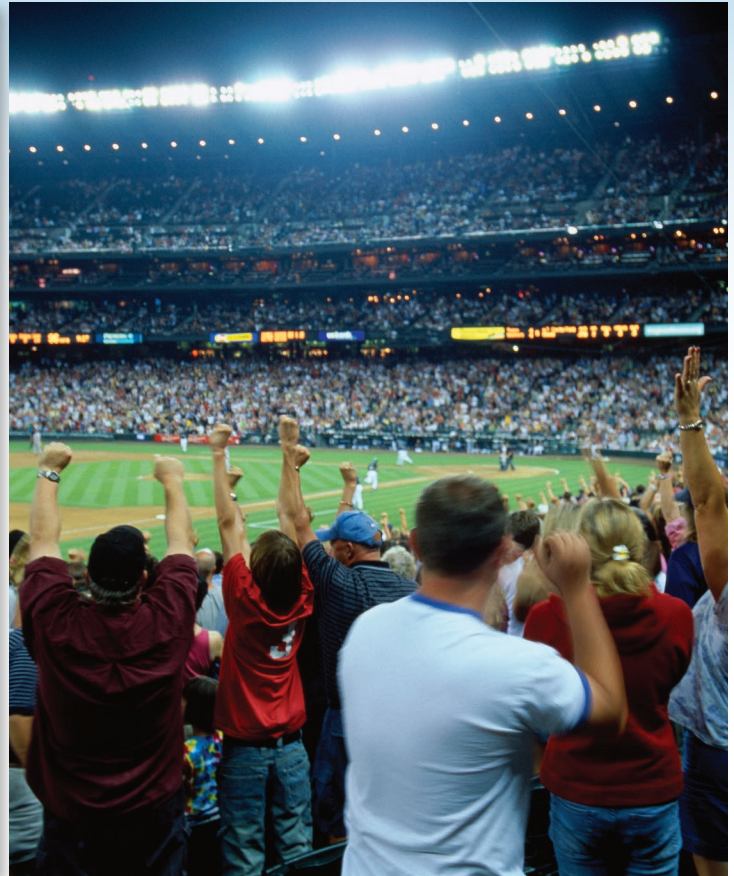

Grant Faint/Getty Images

Capacity planning is a key strategic component in designing the system. It encompasses many basic decisions with long-term consequences for the organization. In this chapter, you will learn about the importance of capacity decisions, the measurement of capacity, how capacity requirements are determined, and the development and evaluation of capacity alternatives. Note that decisions made in the product or service design stage have major implications for capacity planning. Designs have processing requirements related to volume and degree of customization that affect capacity planning.

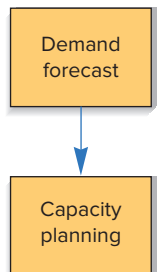

5.1 INTRODUCTION

Hospitals that not too long ago had what could be described as “facility oversupply” are now experiencing what might be called a “capacity crisis” in some areas. The way hospitals plan for capacity is critical to their future success. The same applies to all sorts of organizations, at all levels of these organizations. **Capacity** refers to an upper limit or ceiling on the load that an operating unit can handle. The load might be in terms of the number of physical units produced (e.g., bicycles assembled per hour) or the number of services performed (e.g., computers upgraded per hour). The operating unit might be a plant, department, machine, store, or worker. Capacity needs include equipment, space, and employee skills.

Capacity The upper limit or ceiling on the load that an operating unit can handle.



EXCESS CAPACITY CAN BE BAD NEWS!

Today, huge gaps between supply and demand have many companies struggling. Excess capacity abounds in such major industries as telecom, airline, and auto manufacturing. The bad news is that some companies are losing millions of dollars a year because of this. In the telecom industry, the increasing reach of cellular technology and other kinds of wireless access is continuing to create more and more supply, requiring telecom companies to cut prices and offer incentives to increase demand.

As newer television models come onto the market, demand for older sets declines, leaving manufacturing companies that produce the older type of sets with excess capacity, and prices are greatly reduced.

Similarly, auto manufacturers have to reduce output or close factories for models where demand has fallen substantially (e.g., sedans being replaced by SUVs and pickup trucks).

The goal of strategic capacity planning is to achieve a match between the long-term supply capabilities of an organization and the predicted level of long-term demand. Organizations become involved in capacity planning for various reasons. Among the chief reasons are changes in demand, changes in technology, changes in the environment, and perceived threats or opportunities. A gap between current and desired capacity will result in capacity that is out of balance. Overcapacity (i.e., *excess* capacity) causes operating costs that are too high, while undercapacity (i.e., not enough capacity to meet demand) causes strained resources and a possible loss of customers.

LO5.1 Name the three key questions in capacity planning.

The key questions in capacity planning are the following:

1. What kind of capacity is needed?
2. How much is needed to match demand?
3. When is it needed?

The question of what kind of capacity is needed depends on the products and services that management intends to produce or provide. Hence, in a very real sense, capacity planning is governed by those choices.

Forecasts are key inputs used to answer the questions of how much capacity is needed and when is it needed.

Related questions include:

1. How much will it cost, how will it be funded, and what is the expected return?
2. What are the potential benefits and risks? These involve the degree of uncertainty related to forecasts of the amount of demand and the rate of change in demand, as well as costs, profits, and the time to implement capacity changes. The degree of accuracy that can be attached to forecasts is an important consideration. The likelihood and impact of wrong decisions also need to be assessed.
3. Are there sustainability issues that need to be addressed?
4. Should capacity be changed all at once, or through several (or more) small changes?
5. Can the supply chain handle the necessary changes? Before an organization commits to ramping up its input, it is essential to confirm that its *supply chain* will be able to handle related requirements. And different issues occur for the supply chain when output decreases.

Because of uncertainties, some organizations prefer to delay capacity investment until demand materializes. However, such strategies often inhibit growth because adding capacity takes time and customers won't usually wait. Conversely, organizations that add capacity in anticipation of growth often discover that the new capacity actually attracts growth. Some organizations "hedge their bets" by making a series of small changes and then evaluating the results before committing to the next change.

In some instances, capacity choices are made very infrequently; in others, they are made regularly, as part of an ongoing process. Generally, the factors that influence this frequency are the stability of demand, the rate of technological change in equipment and product design,

and competitive factors. Other factors relate to the type of product or service and whether style changes are important (e.g., automobiles and clothing). In any case, management must review product and service choices periodically to ensure that the company makes capacity changes when they are needed for cost, competitive effectiveness, or other reasons.

5.2 CAPACITY DECISIONS ARE STRATEGIC

LO5.2 Explain the importance of capacity planning.

For a number of reasons, capacity decisions are among the most fundamental of all the design decisions that managers must make. In fact, capacity decisions can be *critical* for an organization.

1. Capacity decisions have a real impact on the ability of the organization to meet future demands for products and services; capacity essentially limits the rate of output possible. Having capacity to satisfy demand can often allow a company to take advantage of tremendous benefits. When Microsoft introduced its new Xbox, there were insufficient supplies, resulting in lost sales and unhappy customers. Similarly, shortages of flu vaccine in some years due to production problems affected capacity, limiting the availability of the vaccine.
2. Capacity decisions affect operating costs. Ideally, capacity and demand requirements will be matched, which will tend to minimize operating costs. In practice, this is not always achieved because actual demand differs from expected demand or tends to vary (e.g., cyclically). In such cases, a decision might be made to attempt to balance the *costs* of over- and undercapacity.
3. Capacity is usually a major determinant of initial cost. Typically, the greater the capacity of a productive unit, the greater its cost. This does not necessarily imply a one-for-one relationship; larger units tend to cost *proportionately* less than smaller units.
4. Capacity decisions often involve a long-term commitment of resources, and once they are implemented, those decisions may be difficult or impossible to modify without incurring major costs.
5. Capacity decisions can affect competitiveness. If a firm has excess capacity, or can quickly add capacity, that fact may serve as a barrier to entry by other firms. Then, too, capacity can affect *delivery speed*, which can be a competitive advantage.
6. Capacity affects the ease of management; having appropriate capacity makes management easier than when capacity is mismatched.
7. Globalization has increased the importance and the complexity of capacity decisions. Far-flung supply chains and distant markets add to the uncertainty about capacity needs.



Thomas Coex/APF/Getty Images

8. Because capacity decisions often involve substantial financial and other resources, it is necessary to plan for them far in advance. For example, it may take years for a new power-generating plant to be constructed and become operational. However, this increases the risk that the designated amount of capacity will not match actual demand or reserve requirements when the capacity becomes available.

LO5.3 Describe ways of defining and measuring capacity.

5.3 DEFINING AND MEASURING CAPACITY

Capacity often refers to an upper limit on the *rate* of output. Even though this seems simple enough, there are subtle difficulties in actually measuring capacity in certain cases. These difficulties arise because of different interpretations of the term *capacity* and problems with identifying suitable measures for a specific situation.

In selecting a measure of capacity, it is important to choose one that does not require updating. For example, dollar amounts are often a poor measure of capacity (e.g., a capacity of \$30 million a year), because price changes necessitate updating of that measure.

Where only one product or service is involved, the capacity of the productive unit may be expressed in terms of that item. However, when multiple products or services are involved, as is often the case, using a simple measure of capacity based on units of output can be misleading. An appliance manufacturer may produce both refrigerators and freezers. If the output rates for these two products are different, it would not make sense to simply state capacity in units without reference to either refrigerators or freezers. The problem is compounded if the firm has other products. One possible solution is to state capacities in terms of each product. Thus, the firm may be able to produce 100 refrigerators per day *or* 80 freezers per day. Sometimes this approach is helpful, sometimes not. For instance, if an organization has many different products or services, it may not be practical to list all of the relevant capacities. This is especially true if there are frequent changes in the mix of output, because this would necessitate a frequently changing composite index of capacity. The preferred alternative in such cases is to use a measure of capacity that refers to *availability of inputs*. Thus, a hospital has a certain number of beds, a factory has a certain number of machine hours available, and a bus has a certain number of seats and a certain amount of standing room.

No single measure of capacity will be appropriate in every situation. Rather, the measure of capacity must be tailored to the situation. Table 5.1 provides some examples of commonly used measures of capacity.

Up to this point, we have been using a general definition of capacity. Although it is functional, it can be refined into two useful definitions of capacity:

1. **Design capacity:** The maximum output rate or service capacity an operation, process, or facility is designed for.
2. **Effective capacity:** Design capacity minus allowances such as personal time, and preventive maintenance.

Design capacity The maximum designed service capacity or output rate.

Effective capacity Design capacity minus allowances such as personal time, equipment maintenance, delays due to scheduling problems, and changing the mix of products.

TABLE 5.1
Measures of capacity

Business	Inputs	Outputs
Auto manufacturing	Labor hours, machine hours	Number of cars per shift
Steel mill	Furnace size	Tons of steel per day
Oil refinery	Refinery size	Gallons of fuel per day
Farming	Number of acres, number of cows	Bushels of grain per acre per year, gallons of milk per day
Restaurant	Number of tables, seating capacity	Number of meals served per day
Theater	Number of seats	Number of tickets sold per performance
Retail sales	Square feet of floor space	Revenue generated per day

Design capacity is the maximum rate of output achieved under ideal conditions. Effective capacity is always less than design capacity, owing to realities of changing product mix, the need for periodic maintenance of equipment, lunch breaks, coffee breaks, problems in scheduling and balancing operations, and similar circumstances. *Actual output* cannot exceed effective capacity and is often less because of machine breakdowns, absenteeism, shortages of materials, and quality problems, as well as factors that are outside the control of the operations managers.

These different measures of capacity are useful in defining two measures of system effectiveness: efficiency and utilization. *Efficiency* is the ratio of actual output to effective capacity. *Capacity utilization* is the ratio of actual output to design capacity.

$$\text{Efficiency} = \frac{\text{Actual output}}{\text{Effective capacity}} \times 100\% \quad (5-1)$$

$$\text{Utilization} = \frac{\text{Actual output}}{\text{Design capacity}} \times 100\% \quad (5-2)$$

Both measures are expressed as percentages.

It is not unusual for managers to focus exclusively on efficiency, but in many instances this emphasis can be misleading. This happens when effective capacity is low compared to design capacity. In those cases, high efficiency would seem to indicate an effective use of resources, when in fact it does not. The following example illustrates this point.

Computing Efficiency and Utilization

Given the following information, compute the efficiency and the utilization of the vehicle repair department:

Design capacity = 50 trucks per day
 Effective capacity = 40 trucks per day
 Actual output = 36 trucks per day

$$\text{Efficiency} = \frac{\text{Actual output}}{\text{Effective capacity}} \times 100\% = \frac{36 \text{ trucks per day}}{40 \text{ trucks per day}} \times 100\% = 90\%$$

$$\text{Utilization} = \frac{\text{Actual output}}{\text{Design capacity}} \times 100\% = \frac{36 \text{ trucks per day}}{50 \text{ trucks per day}} \times 100\% = 72\%$$

EXAMPLE 1

excel
 mhhe.com/stevenson14e

SOLUTION

Compared to the effective capacity of 40 units per day, 36 units per day looks pretty good. However, compared to the design capacity of 50 units per day, 36 units per day is much less impressive, although probably more meaningful.

Because effective capacity acts as a lid on actual output, the real key to improving capacity utilization is to increase effective capacity by correcting quality problems, maintaining equipment in good operating condition, fully training employees, and improving bottleneck operations that constrain output. Eliminating waste, which is a key aspect of lean operation (discussed in Chapter 14), can also help to improve effective capacity.

Hence, increasing utilization depends on being able to increase effective capacity, and this requires a knowledge of what is constraining effective capacity.

The following section explores some of the main determinants of effective capacity. It is important to recognize that the benefits of high utilization are realized only in instances where there is demand for the output. When demand is not there, focusing exclusively on utilization can be counterproductive, because the excess output not only results in additional variable costs but also generates the costs of having to carry the output as inventory. Another disadvantage of high utilization is that operating costs may increase because of increasing waiting time due to bottleneck conditions.

5.4 DETERMINANTS OF EFFECTIVE CAPACITY

LO5.4 Name several determinants of effective capacity.

Many decisions about system design have an impact on capacity. The same is true for many operating decisions. This section briefly describes some of these factors, which are then elaborated on elsewhere in the book. The main factors relate to facilities, products or services, processes, human considerations, operational factors, the supply chain, and external forces.

Facilities The design of facilities, including size and provision for expansion, is key. Locational factors, such as transportation costs, distance to market, labor supply, energy sources, and room for expansion, are also important. Likewise, layout of the work area often determines how smoothly work can be performed, and environmental factors such as heating, lighting, and ventilation also play a significant role in determining whether personnel can perform effectively or whether they must struggle to overcome poor design characteristics.

Product and Service Factors Product or service design can have a tremendous influence on capacity. For example, when items are similar, the ability of the system to produce those items is generally much greater than when successive items differ. Thus, a restaurant that offers a limited menu can usually prepare and serve meals at a faster rate than a restaurant with an extensive menu. Generally speaking, the more uniform the output, the more opportunities there are for standardization of methods and materials, which leads to greater capacity. The particular mix of products or services rendered must also be considered, because different items will have different rates of output.



Mark Richards/PhotoEdit

In only 48 hours, Solectron in San Jose, California, can build to order, ship, and install a complex computer system. Suppliers hold inventory until it is pulled, thereby increasing manufacturing flexibility.



syolacan/Getty Images

Making a violin requires precision and skill from an artisan. Capacity is highly limited when items are specialized and produced one at a time.

Process Factors The quantity capability of a process is an obvious determinant of capacity. A more subtle determinant is the influence of output *quality*. For instance, if quality of output does not meet standards, the rate of output will be slowed by the need for inspection and rework activities. Productivity also affects capacity. Process improvements that increase quality and productivity can result in increased capacity. Also, if multiple products or multiple services are processed in batches, the time to change equipment settings must be taken into account.

- | | |
|----------------------------|-----------------------------------|
| A. Facilities | 5. Compensation |
| 1. Design | 6. Learning rates |
| 2. Location | 7. Absenteeism and labor turnover |
| 3. Layout | E. Policy |
| 4. Environment | F. Operational |
| B. Product/service | 1. Scheduling |
| 1. Design | 2. Materials management |
| 2. Product or service mix | 3. Quality assurance |
| C. Process | 4. Maintenance policies |
| 1. Quantity capabilities | 5. Equipment breakdowns |
| 2. Quality capabilities | G. Supply chain |
| D. Human factors | H. External factors |
| 1. Job content | 1. Product standards |
| 2. Job design | 2. Safety regulations |
| 3. Training and experience | 3. Unions |
| 4. Motivation | 4. Pollution control standards |

TABLE 5.2

Factors that determine effective capacity

Human Factors The tasks that make up a job, the variety of activities involved, and the training, skill, and experience required to perform a job all have an impact on the potential and actual output. In addition, employee motivation has a very basic relationship to capacity, as do absenteeism and labor turnover.

Policy Factors Management policy can affect capacity by allowing or not allowing capacity options such as overtime or second or third shifts.

Operational Factors Scheduling problems may occur when an organization has differences in equipment capabilities among alternative pieces of equipment or differences in job requirements. Inventory stocking decisions, late deliveries, purchasing requirements, acceptability of purchased materials and parts, and quality inspection and control procedures also can have an impact on effective capacity.

Inventory shortages of even one component of an assembled item (e.g., computers, refrigerators, automobiles) can cause a temporary halt to assembly operations until the components become available. This can have a major impact on effective capacity. Thus, insufficient capacity in one area can affect overall capacity.

Supply Chain Factors Supply chain factors must be taken into account in capacity planning if substantial capacity changes are involved. Key questions include: What impact will the changes have on suppliers, warehousing, transportation, and distributors? If capacity will be increased, will these elements of the supply chain be able to handle the increase? Conversely, if capacity is to be decreased, what impact will the loss of business have on these elements of the supply chain?

External Factors Product standards, especially minimum quality and performance standards, can restrict management's options for increasing and using capacity. Thus, pollution standards on products and equipment often reduce effective capacity, as does paperwork required by government regulatory agencies by engaging employees in nonproductive activities. A similar effect occurs when a union contract limits the number of hours and type of work an employee may do.

Table 5.2 summarizes these factors. In addition, *inadequate planning* can be a major limiting determinant of effective capacity.

5.5 STRATEGY FORMULATION

The three primary strategies are leading, following, and tracking. A leading capacity strategy builds capacity in anticipation of future demand increases. If capacity increases involve a long lead time, this strategy may be the best option. A following strategy builds capacity when

demand exceeds current capacity. A tracking strategy is similar to a following strategy, but it adds capacity in relatively small increments to keep pace with increasing demand.

An organization typically bases its capacity strategy on assumptions and predictions about long-term demand patterns, technological changes, and the behavior of its competitors. These typically involve (1) the growth rate and variability of demand, (2) the costs of building and operating facilities of various sizes, (3) the rate and direction of technological innovation, (4) the likely behavior of competitors, and (5) availability of capital and other inputs.

In some instances, a decision may be made to incorporate a **capacity cushion**, which is an amount of capacity in excess of expected demand when there is some uncertainty about demand. $\text{Capacity cushion} = \text{capacity} - \text{expected demand}$. Typically, the greater the degree of demand uncertainty, the greater the amount of cushion used. Organizations that have standard products or services generally have smaller capacity cushions. Cost and competitive priorities are also key factors.

Capacity cushion Extra capacity used to offset demand uncertainty.

Steps in the Capacity Planning Process

1. Estimate future capacity requirements.
2. Evaluate existing capacity and facilities and identify gaps.
3. Identify alternatives for meeting requirements.
4. Conduct financial analyses of each alternative.
5. Assess key qualitative issues for each alternative.
6. Select the alternative to pursue that will be best in the long term.
7. Implement the selected alternative.
8. Monitor results.

Capacity planning can be difficult at times due to the complex influence of market forces and technology.

5.6 FORECASTING CAPACITY REQUIREMENTS

Capacity planning decisions involve both long-term and short-term considerations. Long-term considerations relate to overall *level* of capacity, such as facility size, whereas short-term considerations relate to probable *variations* in capacity requirements created by such things as seasonal, random, and irregular fluctuations in demand. Because the time intervals covered by each of these categories can vary significantly from industry to industry, it would be misleading to put times on the intervals. However, the distinction will serve as a framework within which to discuss capacity planning.

Long-term capacity needs require forecasting demand over a time horizon and then converting those forecasts into capacity requirements. Figure 5.1 illustrates some basic demand patterns that might be identified by a forecast. In addition to basic patterns, there are more complex patterns, such as a combination of cycles and trends.

When trends are identified, the fundamental issues are (1) how long the trend might persist, because few things last forever, and (2) the slope of the trend. If cycles are identified, interest focuses on (1) the approximate length of the cycles and (2) the amplitude of the cycles (i.e., deviation from average).

Short-term capacity needs are less concerned with cycles or trends than with seasonal variations and other variations from average. These deviations are particularly important because they can place a severe strain on a system's ability to satisfy demand at some times and yet result in idle capacity at other times.

An organization can identify seasonal patterns using standard forecasting techniques. Although commonly thought of as annual fluctuations, seasonal variations are also reflected in monthly, weekly, and even daily capacity requirements. Table 5.3 provides some examples of items that tend to exhibit seasonal demand patterns.

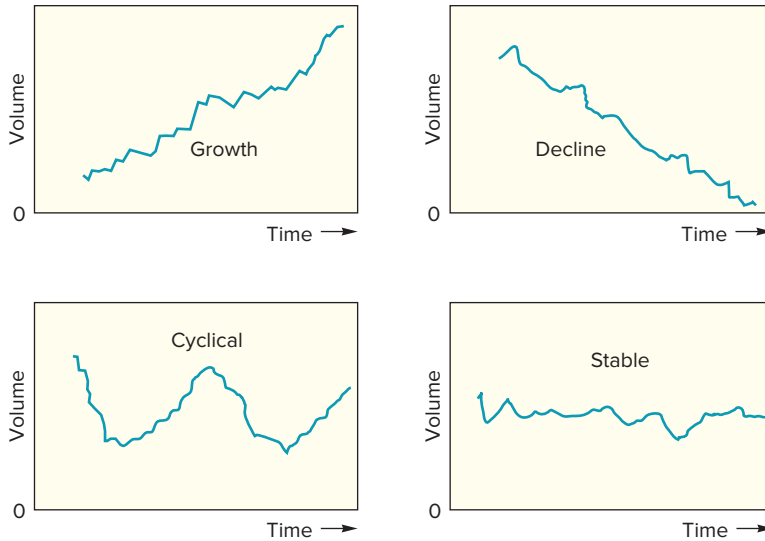

FIGURE 5.1
Common demand patterns

Period	Items
Year	Beer sales, toy sales, airline traffic, clothing, vacations, tourism, power usage, gasoline consumption, sports and recreation, education, power usage
Month	Welfare and Social Security payments, bank transactions
Week	Retail sales, restaurant meals, automobile traffic, automotive rentals, hotel registrations
Day	Power usage, automotive traffic, public transportation, classroom use, retail sales, restaurant meals

TABLE 5.3
Examples of seasonal demand patterns

When time intervals are too short to have seasonal variations in demand, the analysis can often describe the variations by probability distributions such as a normal, uniform, or Poisson distribution. For example, we might describe the amount of coffee served during the midday meal at a luncheonette by a normal distribution with a certain mean and standard deviation. The number of customers who enter a bank branch on Monday mornings might be described by a Poisson distribution with a certain mean. It does not follow, however, that every instance of random variability will lend itself to description by a standard statistical distribution. Service systems, in particular, may experience a considerable amount of variability in capacity requirements unless requests for service can be scheduled. Manufacturing systems, because of their typical isolation from customers and the more uniform nature of production, are likely to experience fewer variations. Waiting-line models and simulation models can be useful when analyzing service systems. These models are described in Chapter 18.

Irregular variations are perhaps the most troublesome, because they are difficult or impossible to predict. They are created by such diverse forces as major equipment breakdowns, freak storms that disrupt normal routines, foreign political turmoil that causes oil shortages, discovery of health hazards (nuclear accidents, unsafe chemical dumping grounds, carcinogens in food and drink), and so on.

The link between marketing and operations is crucial to a realistic determination of capacity requirements. Through customer contracts, demographic analyses, and forecasts, marketing can supply vital information to operations for ascertaining capacity needs for both the long term and the short term.

Calculating Processing Requirements

A necessary piece of information is the capacity requirements of products that will be processed. To get this information, one must have reasonably accurate demand forecasts for each product and know the standard processing time per unit for each product, the number of work-days per year, and the number of shifts that will be used.

EXAMPLE 2

eXcel

mhhe.com/stevenson14e

Determining Needed Capacity

A department works one 8-hour shift, 250 days a year, and has these figures for usage of a machine that is currently being considered:

Product	Annual Demand	Standard Processing Time per Unit (hr)	Processing Time Needed (hr)
1	400	5.0	2,000
2	300	8.0	2,400
3	700	2.0	1,400
			5,800

$$\text{Units of capacity needed} = \frac{\text{Processing time needed}}{\text{Processing time capacity per unit}} \quad (5-3)$$

Working one 8-hour shift 250 days a year provides an annual capacity of $8 \times 250 = 2,000$ hours per year. Consequently, three of these machines would be needed to handle the required volume:

$$\frac{5,800 \text{ hours}}{2,000 \text{ hours/machine}} = 2.90 \text{ machines}$$

The task of determining capacity requirements should not be taken lightly. Substantial losses can occur when there are misjudgments on capacity needs. One key reason for those misjudgments can be overly optimistic projections of demand and growth. Marketing personnel are generally optimistic in their outlook, which isn't necessarily a bad thing. But care must be taken so that that optimism doesn't lead to overcapacity, because the resulting underutilized capacity will create an additional cost burden. Another key reason for misjudgments may be focusing exclusively on sales and revenue potential, and not taking into account the *product mix* that will be needed to generate those sales and revenues. To avoid that, marketing and operations personnel must work closely to determine the optimal product mix needed and the resulting cost and profit.

A reasonable approach to determining capacity requirements is to obtain a forecast of future demand, translate demand into both the *quantity and the timing* of capacity requirements, and then decide what capacity changes (increased, decreased, or no changes) are needed.

Long-term capacity alternatives include the expansion or contraction of an existing facility, opening or closing branch facilities, and the relocation of existing operations. At this point, a decision must be made about whether to make or buy a good, or provide or buy a service.

5.7 ADDITIONAL CHALLENGES OF PLANNING SERVICE CAPACITY

While the foregoing discussion relates generally to capacity planning for both goods and services, it is important to note that capacity planning for services can present special challenges due to the nature of services. Three very important factors in planning service capacity are (1) there may be a need to be near customers, (2) the inability to store services, and (3) the degree of volatility of demand.

Convenience for customers is often an important aspect of service. Generally, a service must be located near customers. For example, hotel rooms must be where customers want to stay; having a vacant room in another city won't help. Thus, capacity and location are closely tied.

Capacity also must be matched with the *timing* of demand. Unlike goods, services cannot be produced in one period and stored for use in a later period. Thus, an unsold seat on an airplane, train, or bus cannot be stored for use on a later trip. Similarly, inventories of goods

allow customers to immediately satisfy wants, whereas a customer who wants a service may have to wait. This can result in a variety of negatives for an organization that provides the service. Thus, speed of delivery, or customer waiting time, becomes a major concern in service capacity planning. For example, deciding on the number of police officers and fire trucks to have on duty at any given time affects the speed of response and brings into issue the *cost* of maintaining that capacity. Some of these issues are addressed in the chapter on waiting lines.

Demand volatility presents problems for capacity planners. It tends to be higher for services than for goods, not only in the timing of demand, but also in the amount of time required to service individual customers. For example, banks tend to experience higher volumes of demand on certain days of the week, and the number and nature of transactions tend to vary substantially for different individuals. Then, too, a wide range of social, cultural, and even weather factors can cause major peaks and valleys in demand. The fact that services can't be stored means service systems cannot turn to inventory to smooth demand requirements on the system the way goods-producing systems are able to. Instead, service planners have to devise other methods of coping with demand volatility and cyclical demand. For example, to cope with peak demand periods, planners might consider hiring extra workers, hiring temporary workers, outsourcing some or all of a service, or using pricing and promotion to shift some demand to slower periods.

In some instances, *demand management strategies* can be used to offset capacity limitations. Pricing, promotions, discounts, and similar tactics can help to shift some demand away from peak periods and into slow periods, allowing organizations to achieve a closer match in supply and demand.

5.8 DO IT IN-HOUSE OR OUTSOURCE IT?

Once capacity requirements have been determined, the organization must decide whether to produce a good or provide a service itself, or to outsource from another organization. Many organizations buy parts or contract out services, for a variety of reasons. Among those factors are:

- **Available capacity.** If an organization has available the equipment, necessary skills, and *time*, it often makes sense to produce an item or perform a service in-house. The additional costs would be relatively small compared with those required to buy items or subcontract services. On the other hand, outsourcing can increase capacity and flexibility.
- **Expertise.** If a firm lacks the expertise to do a job satisfactorily, buying might be a reasonable alternative.
- **Quality considerations.** Firms that specialize can usually offer higher quality than an organization can attain itself. Conversely, unique quality requirements or the desire to closely monitor quality may cause an organization to perform a job itself.
- **The nature of demand.** When demand for an item is high and steady, the organization is often better off doing the work itself. However, wide fluctuations in demand or small orders are usually better handled by specialists who are able to combine orders from multiple sources, which results in higher volume and tends to offset individual buyer fluctuations.
- **Cost.** Any cost savings achieved from buying or making must be weighed against the preceding factors. Cost savings might come from the item itself or from transportation cost savings. If there are fixed costs associated with making an item that cannot be reallocated if the service or product is outsourced, that has to be recognized in the analysis. Conversely, outsourcing may help a firm avoid incurring fixed costs.
- **Risks.** Buying goods or services may entail considerable risks. Loss of direct control over operations, knowledge sharing, and the possible need to disclose proprietary information are three risks. Liability can also be a tremendous risk if the products or services of other companies cause harm to customers or the environment, as well as damage to an organization's reputation. Reputation can also be damaged if the public discovers that a supplier operates with substandard working conditions.

LO5.5 Discuss factors to consider when deciding whether to perform in-house or outsource.



MY COMPLIMENTS TO THE CHEF, ER, BUYER

Ever wonder how some sit-down restaurants are able to offer a huge variety of menu items, and how they are able to serve everything on that menu quickly? Could they have humongous kitchens and a battery of chefs scurrying around? Or maybe a few amazing chefs whose hands are almost quicker than the eye? Maybe, and maybe not. In fact, that great-tasting restaurant entrée or dessert you are served might have been prepared in a distant kitchen, where it was partially cooked, then flash-frozen or vacuum-packed, and shipped to your restaurant, awaiting your order. Then the entrée was finished cooking, perhaps in a microwave oven, and soon it was served to you—fresh made, so to speak. Surprised? Don't be. Many restaurants, from chains like Fuddruggers and Perkins, to top-quality restaurants, are going the outsourcing route. And companies such as Sara Lee, Land O' Lakes, and Stockpot Soup Company of Redwood, Washington, are only too happy to oblige them. Advertisements in

restaurant trade magazines abound, with taglines such as “Hours versus ours” and “Just heat and serve.”

Not exactly like mother used to make, but then mother never had to contend with labor costs that run about 30 percent of revenue, or worry about keeping up with the competition.

Questions

1. Explain the meaning of the phrase “Hours versus ours.”
2. What advantages are there when restaurants outsource?
3. What are some important disadvantages or limitations of outsourcing for restaurants?
4. Do you consider restaurant outsourcing to be dishonest? Unethical? Explain.
5. Does restaurant outsourcing increase capacity? Explain.

In some cases, a firm might choose to perform part of the work itself and let others handle the rest in order to maintain flexibility and to hedge against loss of a subcontractor. If part or all of the work will be done in-house, capacity alternatives will need to be developed.

Outsourcing brings with it a host of supply chain considerations. These are described in Chapter 15.

The reading above describes outsourcing that might surprise you.

LO5.6 Discuss the major considerations related to developing capacity alternatives.

5.9 DEVELOPING CAPACITY STRATEGIES

There are a number of ways to enhance development of capacity strategies:

1. **Design flexibility into systems.** The long-term nature of many capacity decisions and the risks inherent in long-term forecasts suggest potential benefits from designing flexible systems. For example, provision for future expansion in the original design of a structure frequently can be obtained at a small price compared to what it would cost to remodel an existing structure that did not have such a provision. Hence, if future expansion of a restaurant seems likely, water lines, power hookups, and waste disposal lines can be put in place initially so that if expansion becomes a reality, modification to the existing structure can be minimized. Similarly, a new golf course may start as a 9-hole operation, but if provision is made for future expansion by obtaining options on adjacent land, it may progress to a larger (18-hole) course. Other considerations in flexible design involve the layout of equipment, location, equipment selection, production planning, scheduling, and inventory policies, which will be discussed in later chapters.

2. **Take stage of life cycle into account.** Capacity requirements are often closely linked to the stage of the life cycle that a product or service is in. At the *introduction phase*, it can be difficult to determine both the size of the market and the organization's eventual share of that market. Therefore, organizations should be cautious in making large and/or inflexible capacity investments.

In the *growth phase*, the overall market may experience rapid growth. However, the real issue is the rate at which the *organization's* market share grows, which may be more or less than the market rate, depending on the success of the organization's strategies. Organizations generally regard growth as a good thing. They want growth in the overall market for their products or services, and in their share of the market, because they see this as a way of increasing volume, and thus, increasing profits. However, there can also be a downside to this because increasing output levels will require increasing capacity, and that means increasing investment and increasing complexity. In addition, decision makers should take into account

possible similar moves by competitors, which would increase the risk of overcapacity in the market, and result in higher unit costs of the output. Another strategy would be to compete on some nonprice attribute of the product by investing in technology and process improvements to make differentiation a competitive advantage.

In the *maturity phase*, the size of the market levels off, and organizations tend to have stable market shares. Organizations may still be able to increase profitability by reducing costs and making full use of capacity. However, some organizations may still try to increase profitability by increasing capacity if they believe this stage will be fairly long, or the cost to increase capacity is relatively small.

In the *decline phase*, an organization is faced with underutilization of capacity due to declining demand. Organizations may eliminate the excess capacity by selling it, or by introducing new products or services. An option that is sometimes used in manufacturing is to transfer capacity to a location that has lower labor costs, which allows the organization to continue to make a profit on the product for a while longer.

3. **Take a “big-picture” (i.e., systems) approach to capacity changes.** When developing capacity alternatives, it is important to consider how parts of the system interrelate. For example, when making a decision to increase the number of rooms in a motel, one should also take into account probable increased demands for parking, entertainment and food, and housekeeping. Also, will suppliers be able to handle the increased volume?

Capacity changes inevitably affect an organization’s supply chain. Suppliers may need time to adjust to their capacity, so collaborating with supply chain partners on plans for capacity increases is essential. That includes not only suppliers, but also distributors and transporters.

The risk in not taking a big-picture approach is that the system will be unbalanced. Evidence of an unbalanced system is the existence of a *bottleneck operation*. A **bottleneck operation** is an operation in a sequence of operations whose capacity is lower than the capacities of other operations in the sequence. As a consequence, the capacity of the bottleneck operation limits the system capacity; the capacity of the system is reduced to the capacity of the bottleneck operation. Figure 5.2 illustrates this concept: Four operations generate work that must then be processed by a fifth operation. The four different operations each have a capacity of 10 units per hour, for a total capacity of 40 units per hour. However, the fifth operation can only process 30 units per hour. Consequently, the output of the system will only be 30 units per hour. If the other operations operate at capacity, a line of units waiting to be processed by the bottleneck operation will build up at the rate of 10 per hour.

Bottleneck operation An operation in a sequence of operations whose capacity is lower than that of the other operations.

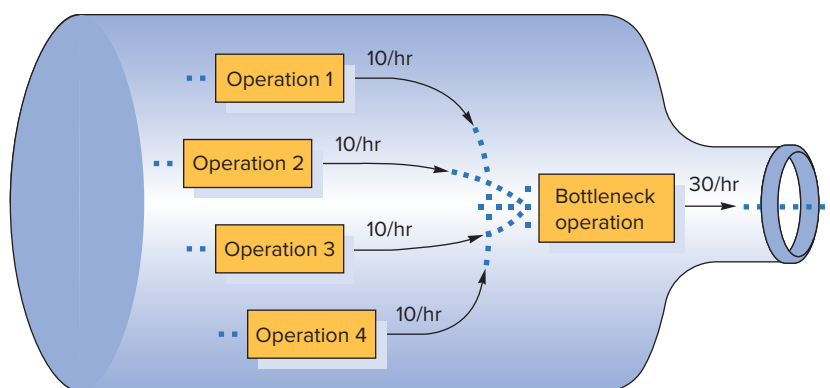
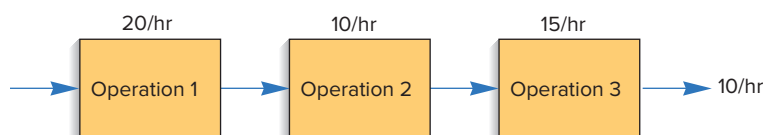

FIGURE 5.2
Bottleneck operation



Here is another perspective. The following diagram illustrates a three-step process, with capacities of each step shown. However, the middle process, because its capacity is lower than that of the others, constrains the system to its capacity of 10 units per hour. Hence, it is a bottleneck. In order to increase the capacity of the entire process, it would be necessary to increase the capacity of this bottleneck operation. Note, though, that the potential for increasing the capacity of the process is only 5 units, to 15 units per hour. Beyond that, Operation 3's capacity would limit process capacity to 15 units per hour.

4. **Prepare to deal with capacity “chunks.”** Capacity increases are often acquired in fairly large chunks rather than smooth increments, making it difficult to achieve a match between desired capacity and feasible capacity. For instance, the desired capacity of a certain operation may be 55 units per hour, but suppose that machines used for this operation are able to produce 40 units per hour each. One machine by itself would cause capacity to be 15 units per hour short of what is needed, but two machines would result in an excess capacity of 25 units per hour. The illustration becomes even more extreme if we shift the topic—to open-heart surgery furnaces or to the number of airplanes needed to provide a desired level of capacity.

5. **Attempt to smooth out capacity requirements.** Unevenness in capacity requirements also can create certain problems. For instance, during periods of inclement weather, public transportation ridership tends to increase substantially relative to periods of pleasant weather. Consequently, the system tends to alternate between underutilization and overutilization. Increasing the number of buses or subway cars will reduce the burden during periods of heavy demand, but this will aggravate the problem of overcapacity at other times and certainly add to the cost of operating the system.

We can trace the unevenness in demand for products and services to a variety of sources. The bus ridership problem is weather related to a certain extent, but demand could be considered to be partly random (i.e., varying because of chance factors). Still another source of varying demand is seasonality. Seasonal variations are generally easier to cope with than random variations because they are *predictable*. Consequently, management can make allowances in planning and scheduling activities and inventories. However, seasonal variations can still pose problems because of their uneven demands on the system: At certain times the



Fotokostic/Shutterstock



Vadim Zakharishchev/Shutterstock

Capacity requirements are affected by seasonal variations. One approach is to identify products that offset each other, such as demand for water skis and demand for snow skis.

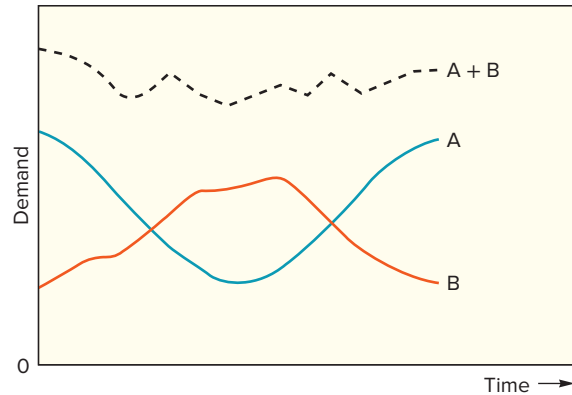
**FIGURE 5.3**

A and B have complementary demand patterns

system will tend to be overloaded, while at other times it will tend to be underloaded. One possible approach to this problem is to identify products or services that have complementary demand patterns—that is, patterns that tend to offset each other. For instance, demand for snow skis and demand for water skis might complement each other: Demand for water skis is greater in the spring and summer months, and demand for snow skis is greater in the fall and winter months. The same might apply to heating and air-conditioning equipment. The ideal case is one in which products or services with complementary demand patterns involve the use of the same resources but at different times, so that overall capacity requirements remain fairly stable and inventory levels are minimized. Figure 5.3 illustrates complementary demand patterns.

Variability in demand can pose a problem for managers. Simply adding capacity by increasing the size of the operation (e.g., increasing the size of the facility, the workforce, or the amount of processing equipment) is not always the best approach, because that reduces flexibility and adds to fixed costs. Consequently, managers often choose to respond to higher than normal demand in other ways. One way is through the use of overtime work. Another way is to subcontract some of the work. A third way is to draw down finished goods inventories during periods of high demand and replenish them during periods of slow demand. These options and others are discussed in detail in the chapter on aggregate planning.

6. Identify the optimal operating level. Production units typically have an ideal or optimal level of operation in terms of unit cost of output. At the ideal level, cost per unit is the lowest for that production unit. If the output rate is less than the optimal level, increasing the output rate will result in decreasing average unit costs. This is known as **economies of scale**. However, if output is increased beyond the optimal level, average unit costs will become increasingly larger. This is known as **diseconomies of scale**. Figure 5.4 illustrates these concepts.

Economies of scale If the output rate is less than the optimal level, increasing the output rate results in decreasing average unit costs.

Diseconomies of scale If the output rate is more than the optimal level, increasing the output rate results in increasing average unit costs.

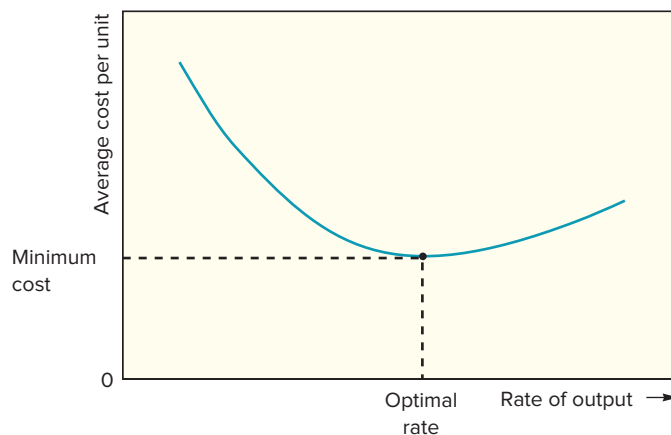
**FIGURE 5.4**

Production units have an optimal rate of output for minimum cost

Reasons for economies of scale include the following:

- Fixed costs are spread over more units, reducing the fixed cost per unit.
- Construction costs increase at a decreasing rate with respect to the size of the facility to be built.
- Processing costs decrease as output rates increase because operations become more standardized, which reduces unit costs.

Reasons for diseconomies of scale include the following:

- Distribution costs increase due to traffic congestion and shipping from one large centralized facility instead of several smaller, decentralized facilities.
- Complexity increases costs; control and communication become more problematic.
- Inflexibility can be an issue.
- Additional levels of bureaucracy exist, slowing decision making and approvals for changes.

The explanation for the shape of the cost curve is that at low levels of output, the costs of facilities and equipment must be absorbed (paid for) by very few units. Hence, the cost per unit is high. As output is increased, there are more units to absorb the “fixed” cost of facilities and equipment, so unit costs decrease. However, beyond a certain point, unit costs will start to rise. To be sure, the fixed costs are spread over even more units, so that does not account for the increase, but other factors now become important: worker fatigue; equipment break-downs; the loss of flexibility, which leaves less of a margin for error; and, generally, greater difficulty in coordinating operations.

Both optimal operating rate and the amount of the minimum cost tend to be a function of the general capacity of the operating unit. For example, as the general capacity of a plant increases, the optimal output rate increases and the minimum cost for the optimal rate decreases. Thus, larger plants tend to have higher optimal output rates and lower minimum costs than smaller plants. Figure 5.5 illustrates these points.

In choosing the capacity of an operating unit, management must take these relationships into account along with the availability of financial and other resources and forecasts of expected demand. To do this, it is necessary to determine enough points for each size facility to be able to make a comparison among different sizes. In some instances, facility sizes are givens, whereas in others, facility size is a continuous variable (i.e., any size can be selected). In the latter case, an ideal facility size can be selected. Usually, management must make a choice from given sizes, and none may have a minimum at the desired rate of output.

7. Choose a strategy if expansion is involved. Consider whether incremental expansion or single step is more appropriate. Factors include competitive pressures, market opportunities, costs and availability of funds, disruption of operations, and training requirements. Also, decide whether to lead or follow competitors. Leading is more risky, but it may have greater potential for rewards.

FIGURE 5.5

Minimum cost and optimal operating rate are functions of the size of a production unit

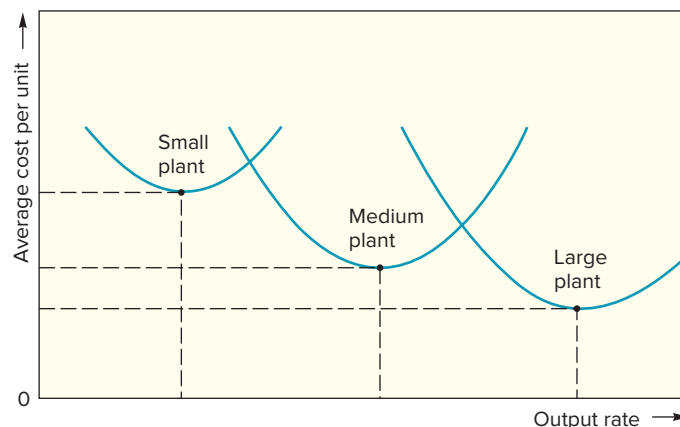

5.10 CONSTRAINT MANAGEMENT

A **constraint** is something that limits the performance of a process or system in achieving its goals. Constraint management is often based on the work of Eli Goldratt (*The Theory of Constraints*), and Eli Schragenheim and H. William Dettmer (*Manufacturing at Warp Speed*). There are seven categories of constraints:

Market: Insufficient demand

Resource: Too little of one or more resources (e.g., workers, equipment, and space), as illustrated in Figure 5.2

Material: Too little of one or more materials

Financial: Insufficient funds

Supplier: Unreliable, long lead time, substandard quality

Knowledge or competency: Needed knowledge or skills missing or incomplete

Policy: Laws or regulations interfere

There may only be a few constraints, or there may be more than a few. Constraint issues can be resolved by using the following five steps:¹

1. Identify the most pressing constraint. If it can easily be overcome, do so, and return to Step 1 for the next constraint. Otherwise, proceed to Step 2.
2. Change the operation to achieve the maximum benefit, given the constraint. This may be a short-term solution.
3. Make sure other portions of the process are supportive of the constraint (e.g., bottleneck operation).
4. Explore and evaluate ways to overcome the constraint. This will depend on the type of constraint. For example, if demand is too low, advertising or price change may be an option. If capacity is the issue, working overtime, purchasing new equipment, and outsourcing are possible options. If additional funds are needed, working to improve cash flow, borrowing, and issuing stocks or bonds may be options. If suppliers are a problem, work with them, find more desirable suppliers, or do things in-house. If knowledge or skills are needed, seek training or consultants, or outsource. If laws or regulations are the issue, working with lawmakers or regulators may be an option.
5. Repeat the process until the level of constraints is acceptable.

Constraint Something that limits the performance of a process or system in achieving its goals.

LO5.7 Describe the steps used to resolve constraint issues.

5.11 EVALUATING ALTERNATIVES

An organization needs to examine alternatives for future capacity from a number of different perspectives. Most obvious are economic considerations: Will an alternative be economically feasible? How much will it cost? How soon can we have it? What will operating and maintenance costs be? What will its useful life be? Will it be compatible with present personnel and present operations?

Less obvious, but nonetheless important, is possible negative public opinion. For instance, the decision to build a new power plant is almost sure to stir up reaction, whether the plant is gas-fired, hydroelectric, or nuclear. Any option that could disrupt lives and property is bound to generate hostile reactions. Construction of new facilities may necessitate moving personnel to a new location. Embracing a new technology may mean retraining some people and terminating some jobs. Relocation can cause unfavorable reactions, particularly if a town is about to lose a major employer. Conversely, community pressure in a new location may arise if the presence of the company is viewed unfavorably (noise, traffic, pollution).

LO5.8 Briefly describe approaches that are useful for evaluating capacity alternatives.

¹Adapted from Eli Schragenheim and H. William Dettmer, *Manufacturing at Warp Speed* (Boca Raton: St. Lucie Press, 2000).

TABLE 5.4

Cost–volume symbols

FC = Fixed cost
VC = Total variable cost
v = Variable cost per unit
TC = Total cost
TR = Total revenue
R = Revenue per unit
Q = Quantity or volume of output
Q_{BEP} = Break-even quantity
P = Profit

A number of techniques are useful for evaluating capacity alternatives from an economic standpoint. Some of the more common are cost–volume analysis, financial analysis, decision theory, and waiting-line analysis. Cost–volume analysis is described in this section. Financial analysis is mentioned briefly, decision analysis is described in the chapter supplement, and waiting-line analysis is described in Chapter 18.

Cost–Volume Analysis

Cost–volume analysis focuses on relationships between cost, revenue, and volume of output. The purpose of cost–volume analysis is to estimate the income of an organization under different operating conditions. It is particularly useful as a tool for comparing capacity alternatives.

Use of the technique requires identification of all costs related to the production of a given product. These costs are then designated as fixed costs or variable costs. *Fixed costs* tend to remain constant regardless of volume of output. Examples include rental costs, property taxes, equipment costs, heating and cooling expenses, and certain administrative costs. *Variable costs* vary directly with volume of output. The major components of variable costs are generally materials and labor costs. We will assume that variable cost per unit remains the same regardless of volume of output, and that all output can be sold.

Table 5.4 summarizes the symbols used in the cost–volume formulas.

The total cost associated with a given volume of output is equal to the sum of the fixed cost and the variable cost per unit times volume:

$$TC = FC + VC \quad (5-4)$$

$$VC = Q \times v \quad (5-5)$$

where v = variable cost per unit. Figure 5.6A shows the relationship between volume of output and fixed costs, total variable costs, and total (fixed plus variable) costs.

Revenue per unit, like variable cost per unit, is assumed to be the same regardless of quantity of output. Total revenue will have a linear relationship to output, as illustrated in Figure 5.6B. The total revenue associated with a given quantity of output, Q , is

$$TR = R \times Q \quad (5-6)$$

Figure 5.6C describes the relationship between profit—which is the difference between total revenue and total (i.e., fixed plus variable) cost—and volume of output. The volume at which total cost and total revenue are equal is referred to as the **break-even point (BEP)**. When volume is less than the break-even point, there is a loss; when volume is greater than the break-even point, there is a profit. The greater the deviation from this point, the greater the profit or loss. Figure 5.6D shows total profit or loss relative to the break-even point. Figure 5.6D can be obtained from Figure 5.6C by drawing a horizontal line through the point where the total cost and total revenue lines intersect. Total profit can be computed using the formula

$$P = TR - TC = R \times Q - (FC + v \times Q)$$

Rearranging terms, we have

$$P = Q(R - v) - FC \quad (5-7)$$

The difference between revenue per unit and variable cost per unit, $R - v$, is known as the *contribution margin*.

The required volume, Q , needed to generate a specified profit is

$$Q = \frac{P + FC}{R - v} \quad (5-8)$$

A special case of this is the volume of output needed for total revenue to equal total cost. This is the break-even point, computed using the formula

Break-even point (BEP) The volume of output at which total cost and total revenue are equal.

FIGURE 5.6
Cost–volume relationships

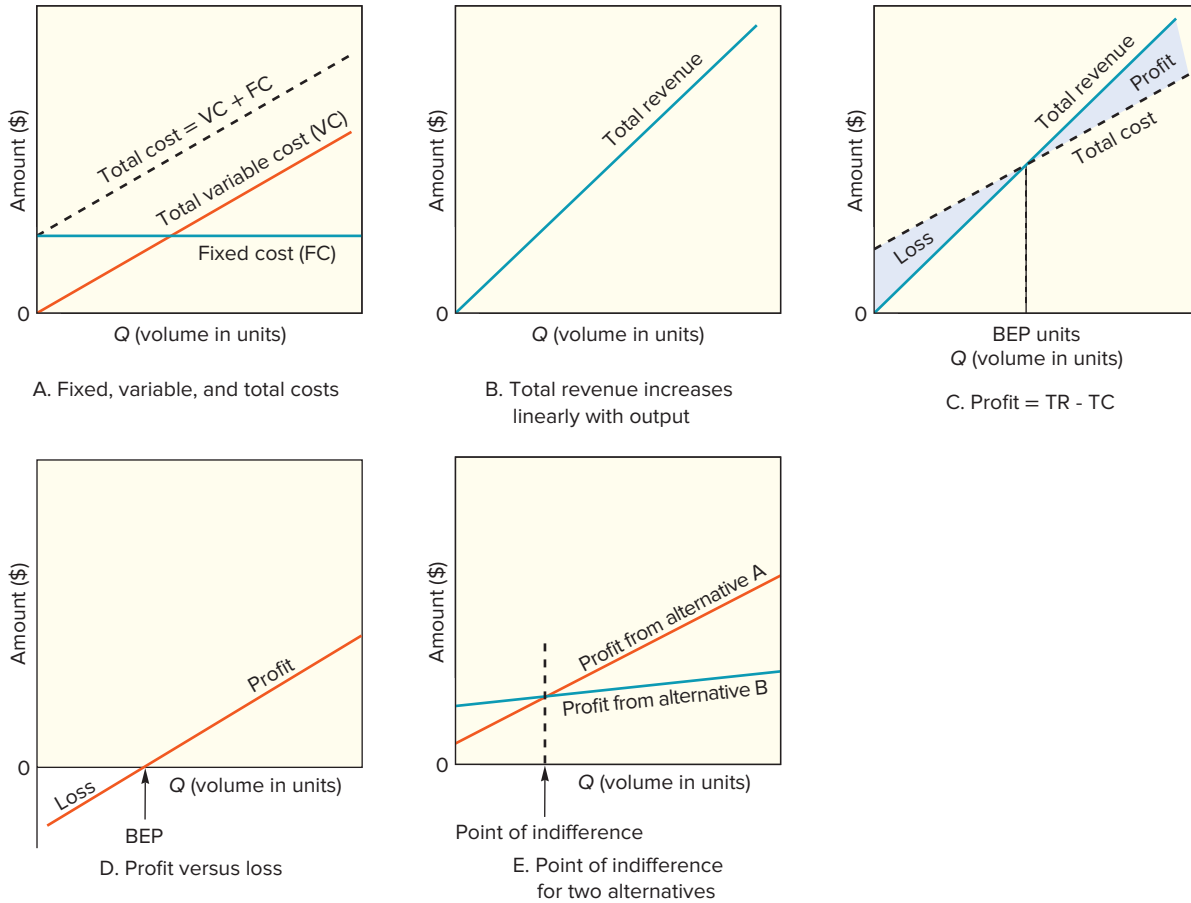

$$Q_{\text{BEP}} = \frac{FC}{R - v} \quad (5-9)$$

Different alternatives can be compared by plotting the profit lines for the alternatives, as shown in Figure 5.6E.

Figure 5.6E illustrates the concept of an **indifference point**: the quantity at which a decision maker would be indifferent between two competing alternatives. In this illustration, a quantity less than the point of indifference would favor choosing alternative B because its profit is higher in that range, while a quantity greater than the point of indifference would favor choosing alternative A.

Indifference point The quantity that would make two alternatives equivalent.

Break-even Point and Profit Analysis

The owner of Old-Fashioned Berry Pies, S. Simon, is contemplating adding a new line of pies, which will require leasing new equipment for a monthly payment of \$6,000. Variable costs would be \$2 per pie, and pies would retail for \$7 each.

- How many pies must be sold in order to break even?
- What would the profit (loss) be if 1,000 pies are made and sold in a month?
- How many pies must be sold to realize a profit of \$4,000?
- If 2,000 can be sold, and a profit target is \$5,000, what price should be charged per pie?

EXAMPLE 3

excel
mhhe.com/stevenson14e

SOLUTION

FC = \$6,000, VC = \$2 per pie, R = \$7 per pie

- a. $Q_{BEP} = \frac{FC}{R - VC} = \frac{\$6,000}{\$7 - \$2} = 1,200$ pies/month
- b. For $Q = 1,000$, $P = Q(R - v) - FC = 1,000(\$7 - \$2) - \$6,000 = -\$1,000$
- c. $P = \$4,000$; solve for Q using Formula 5-8:

$$Q = \frac{\$4,000 + \$6,000}{\$7 - \$2} = 2,000$$
 pies
- d. Profit = $Q(R - v) - FC$

$$\$5,000 = 2,000(R - \$2) - \$6,000$$

$$R = \$7.50$$

Capacity alternatives may involve *step costs*, which are costs that increase stepwise as potential volume increases. For example, a firm may have the option of purchasing one, two, or three machines, with each additional machine increasing the fixed cost, although perhaps not linearly. (See Figure 5.7A.) Then, fixed costs and potential volume would depend on the number of machines purchased. The implication is that *multiple break-even quantities* may occur, possibly one for each range. Note, however, that the total revenue line might not intersect the fixed-cost line in a particular range, meaning that there would be no break-even point in that range. This possibility is illustrated in Figure 5.7B, where there is no break-even point in the first range. In order to decide how many machines to purchase, a manager must consider projected annual demand (volume) relative to the multiple break-even points and choose the most appropriate number of machines, as Example 4 shows.

FIGURE 5.7
Break-even problem with step fixed costs

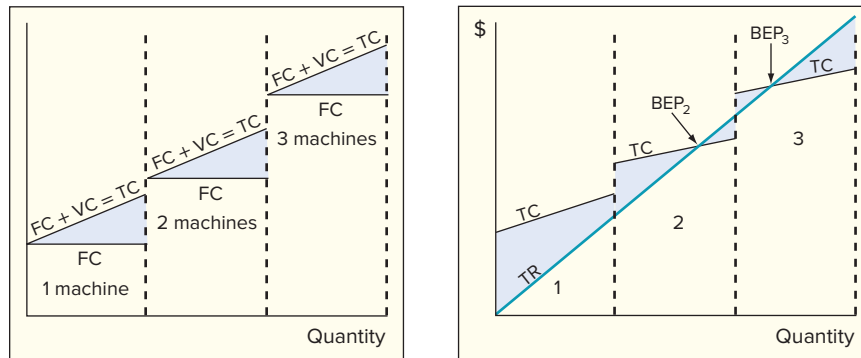

A. Step fixed costs and variable costs

B. Multiple break-even points

EXAMPLE 4

Determining the Break-even Point

eXcel
mhhe.com/stevenson14e

A manager has the option of purchasing one, two, or three machines. Fixed costs and potential volumes are as follows:

Number of Machines	Total Annual Fixed Costs	Corresponding Range of Output
1	\$ 9,600	0 to 300
2	15,000	301 to 600
3	20,000	601 to 900

Variable cost is \$10 per unit, and revenue is \$40 per unit.

- a. Determine the break-even point for each range.
- b. If projected annual demand is between 580 and 660 units, how many machines should the manager purchase?

SOLUTION

- a. Compute the break-even point for each range using the formula $Q_{\text{BEP}} = FC/(R - v)$.
- For one machine : $Q_{\text{BEP}} = \frac{\$9,600}{\$40/\text{unit} - \$10/\text{unit}} = 320 \text{ units}$ [not in range, so there is no BEP]
- For two machines : $Q_{\text{BEP}} = \frac{\$15,000}{\$40/\text{unit} - \$10/\text{unit}} = 500 \text{ units}$
- For three machines : $Q_{\text{BEP}} = \frac{\$20,000}{\$40/\text{unit} - \$10/\text{unit}} = 666.67 \text{ units}$
- b. Comparing the projected range of demand to the two ranges for which a break-even point occurs (see Figure 5.7B), you can see that the break-even point is 500, which is in the range 301 to 600. This means that even if demand is at the low end of the range, it would be above the break-even point and thus yield a profit. That is not true of range 601 to 900. At the top end of projected demand, the volume would still be less than the break-even point for that range, so there would be no profit. Hence, the manager should choose two machines.

Cost–volume analysis can be a valuable tool for comparing capacity alternatives if certain assumptions are satisfied:

- One product is involved.
- Everything produced can be sold.
- The variable cost per unit is the same regardless of the volume.
- Fixed costs do not change with volume changes, or they are step changes.
- The revenue per unit is the same regardless of volume.
- Revenue per unit exceeds variable cost per unit.

As with any quantitative tool, it is important to verify that the assumptions on which the technique is based are reasonably satisfied for a particular situation. For example, revenue per unit or variable cost per unit is not always constant. In addition, fixed costs may not be constant over the range of possible output. If demand is subject to random variations, one must take that into account in the analysis. Also, cost–volume analysis requires that fixed and variable costs can be separated, and this is sometimes exceedingly difficult to accomplish. Cost–volume analysis works best with one product or a few products that have the same cost characteristics.

A notable benefit of cost–volume considerations is the conceptual framework it provides for integrating cost, revenue, and profit estimates into capacity decisions. If a proposal looks attractive using cost–volume analysis, the next step would be to develop cash flow models to see how it fares with the addition of time and more flexible cost functions.

Financial Analysis

Operations personnel need to have the ability to do *financial analysis*. A problem that is universally encountered by managers is how to allocate scarce funds. A common approach is to use financial analysis to rank investment proposals, taking into account the *time value of money*.

Two important terms in financial analysis are *cash flow* and *present value*:

Cash flow refers to the difference between the cash received from sales (of goods or services) and other sources (e.g., sale of old equipment) and the cash outflow for labor, materials, overhead, and taxes.

Present value expresses in current value the sum of all future cash flows of an investment proposal.

The three most commonly used methods of financial analysis are payback, present value, and internal rate of return.

Cash flow The difference between cash received from sales and other sources, and cash outflow for labor, material, overhead, and taxes.

Present value The sum, in current value, of all future cash flows of an investment proposal.

Payback is a crude but widely used method that focuses on the length of time it will take for an investment to return its original cost. For example, an investment with an original cost of \$6,000 and a monthly net cash flow of \$1,000 has a payback period of six months.

EXAMPLE 5**Determining Payback Time****eXcel**

mhhe.com/stevenson14e

A new machine will cost \$2,000, but it will result in savings of \$500 per year. What is the payback time in years?

SOLUTION

Initial cost = \$2,000 Annual savings = \$500

The payback time is initial cost divided by annual savings. Thus, the payback time is

$$\text{Payback time} = \frac{\text{Initial cost}}{\text{Annual saving}} = \frac{\$2,000}{\$500/\text{yr}} = 4 \text{ years}$$

Payback doesn't take into account the *time value of money*. Its use is easier to rationalize for short-term paybacks than for long-term paybacks. The *present value (PV)* method does take the time value of money into account. It summarizes the initial cost of an investment, its estimated annual cash flows, and any expected salvage value in a single value called the *equivalent current value*, taking into account the time value of money (i.e., interest rates).

The *internal rate of return (IRR)* summarizes the initial cost, expected annual cash flows, and estimated future salvage value of an investment proposal in an *equivalent interest rate*. In other words, this method identifies the rate of return that equates the estimated future returns and the initial cost.

These techniques are appropriate when there is a high degree of *certainty* associated with estimates of future cash flows. In many instances, however, operations managers and other managers must deal with situations better described as risky or uncertain. When conditions of risk or uncertainty are present, decision theory is often applied.

Decision Theory

Decision theory is a helpful tool for financial comparison of alternatives under conditions of risk or uncertainty. It is suited to capacity decisions and to a wide range of other decisions managers must make. It involves identifying a set of possible future conditions that could influence results, listing alternative courses of action, and developing a financial outcome for each alternative–future condition combination. Decision theory is described in the supplement to this chapter.

Waiting-Line Analysis

Analysis of lines is often useful for designing or modifying service systems. Waiting lines have a tendency to form in a wide variety of service systems (e.g., airport ticket counters, telephone calls to a cable television company, hospital emergency rooms). The lines are symptoms of bottleneck operations. Analysis is useful in helping managers choose a capacity level that will be cost-effective through balancing the cost of having customers wait with the cost of providing additional capacity. It can aid in the determination of expected costs for various levels of service capacity.

This topic is described in Chapter 18.

Simulation

Simulation can be a useful tool in evaluating what-if scenarios, and is described on this book's website.

5.12 OPERATIONS STRATEGY

The strategic implications of capacity decisions can be enormous, impacting all areas of the organization. From an operations management standpoint, capacity decisions establish a set of conditions within which operations will be required to function. Hence, it is extremely important to include input from operations management people in making capacity decisions.

Flexibility can be a key issue in capacity decisions, although flexibility is not always an option, particularly in capital-intensive industries. However, where possible, flexibility allows an organization to be agile—that is, responsive to changes in the marketplace. Also, it reduces to a certain extent the dependence on long-range forecasts to accurately predict demand. And flexibility makes it easier for organizations to take advantage of technological and other innovations. Maintaining excess capacity (a capacity cushion) may provide a degree of flexibility, albeit at added cost.

Some organizations use a strategy of maintaining a capacity cushion for the purpose of blocking entry into the market by new competitors. The excess capacity enables them to produce at costs lower than what new competitors can. However, such a strategy means higher-than-necessary unit costs, and it makes it more difficult to cut back if demand slows, or to shift to new product or service offerings.

Efficiency improvements and utilization improvements can provide capacity increases. Such improvements can be achieved by streamlining operations and reducing waste. The chapter on lean operations describes ways for achieving those improvements.

Bottleneck management can be a way to increase effective capacity, by scheduling non-bottleneck operations to achieve maximum utilization of bottleneck operations.

In cases where capacity expansion will be undertaken, there are two strategies for determining the timing and degree of capacity expansion. One is the *expand-early* strategy (i.e., before demand materializes). The intent might be to achieve economies of scale, to expand market share, or to preempt competitors from expanding. The risks of this strategy include an oversupply that would drive prices down, and underutilized equipment that would result in higher unit costs.

The other approach is the *wait-and-see strategy* (i.e., to expand capacity only after demand materializes, perhaps incrementally). Its advantages include a lower chance of oversupply due to more accurate matching of supply and demand, and higher capacity utilization. The key risks are loss of market share and the inability to meet demand if expansion requires a long lead time.

In cases where capacity contraction will be undertaken, *capacity disposal* strategies become important. This can be the result of the need to replace aging equipment with newer equipment. It can also be the result of outsourcing and downsizing operations. The cost or benefit of asset disposal should be taken into account when contemplating these actions.

Capacity refers to a system's potential for producing goods or delivering services over a specified time interval. Capacity decisions are important because capacity is a ceiling on output and a major determinant of operating costs.

Three key inputs to capacity planning are the kind of capacity that will be needed, how much will be needed, and when it will be needed. Accurate forecasts are critical to the planning process.

The capacity planning decision is one of the most important decisions that managers make. The capacity decision is strategic and long term in nature, often involving a significant initial investment of capital. Capacity planning is particularly difficult in cases where returns will accrue over a lengthy period, and risk is a major consideration.

A variety of factors can interfere with effective capacity, so effective capacity is usually somewhat less than design capacity. These factors include facilities design and layout, human factors, product/service design, equipment failures, scheduling problems, and quality considerations.

Capacity planning involves long-term and short-term considerations. Long-term considerations relate to the overall level of capacity; short-term considerations relate to variations in capacity requirements due to seasonal, random, and irregular fluctuations in demand. Ideally, capacity will match demand.

SUMMARY

Thus, there is a close link between forecasting and capacity planning, particularly in the long term. In the short term, emphasis shifts to describing and coping with variations in demand.

Development of capacity alternatives is enhanced by taking a systems approach to planning, by recognizing that capacity increments are often acquired in chunks, by designing flexible systems, and by considering product/service complements as a way of dealing with various patterns of demand.

In evaluating capacity alternatives, a manager must consider both quantitative and qualitative aspects. Quantitative analysis usually reflects economic factors, and qualitative considerations include intangibles such as public opinion and personal preferences of managers. Cost–volume analysis can be useful for analyzing alternatives.

KEY POINTS

1. Capacity decisions can be critical to the success of a business organization because capacity is the supply side of the supply–demand equation, and too little or too much capacity is costly.
2. The key issues in capacity planning relate to determining what kind of capacity is needed, how much is needed, and when it is needed.
3. Volatile demand and long lead times to achieve capacity changes can be challenging.
4. One or more constraints can adversely affect the overall capacity of a system (see, for example, Figure 5.2). Capacity increases can only be achieved by loosening those constraints, not by increasing other resources, so it is essential to identify constraining resources and focus efforts on overcoming them.

KEY TERMS

- | | | |
|-----------------------------|----------------------------|-------------------------|
| bottleneck operation, 203 | cash flow, 211 | economies of scale, 205 |
| break-even point (BEP), 208 | constraint, 207 | effective capacity, 194 |
| capacity, 191 | design capacity, 194 | indifference point, 209 |
| capacity cushion, 198 | diseconomies of scale, 205 | present value, 211 |

SOLVED PROBLEMS

Problem 1

 mhhe.com/stevenson14e

A firm’s manager must decide whether to make or buy a certain item used in the production of vending machines. Making the item would involve annual lease costs of \$150,000. Cost and volume estimates are as follows:

	Make	Buy
Annual fixed cost	\$150,000	None
Variable cost/unit	\$ 60	\$ 80
Annual volume (units)	12,000	12,000

- Given these numbers, should the firm buy or make this item?
- There is a possibility that volume could change in the future. At what volume would the manager be indifferent between making and buying?

Solution

- Determine the annual cost of each alternative:
 Total cost = Fixed cost + Volume × Variable cost
 Make: \$150,000 + 12,000(\$60) = \$870,000
 Buy: 0 + 12,000(\$80) = \$960,000

Because the annual cost of making the item is less than the annual cost of buying it, the manager would reasonably choose to make the item. *Note:* If the unit cost to buy had been *less than the variable cost* to make, there would be no need to even consider fixed costs; it would simply have been better to buy.

- To determine the volume at which the two choices would be equivalent, set the two total costs equal to each other and solve for volume: $TC_{\text{make}} = TC_{\text{buy}}$. Thus, $\$150,000 + Q(\$60) = 0 + Q(\$80)$. Solving, $Q = 7,500$ units. Therefore, at a volume of 7,500 units a year, the manager would be indifferent between making and buying. For lower volumes, the choice would be to buy, and for higher volumes, the choice would be to make.

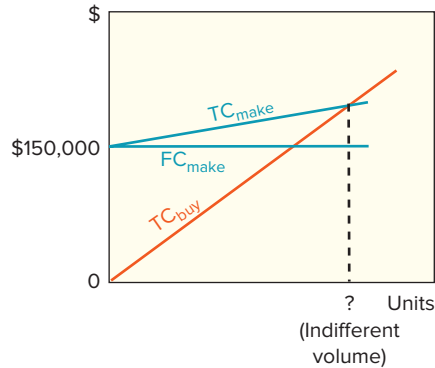

A small firm produces and sells automotive items in a five-state area. The firm expects to consolidate assembly of its battery chargers line at a single location. Currently, operations are in three widely scattered locations. The leading candidate for location will have a monthly fixed cost of \$42,000 and variable costs of \$3 per charger. Chargers sell for \$7 each. Prepare a table that shows total profits, fixed costs, variable costs, and revenues for monthly volumes of 10,000, 12,000, and 15,000 units. What is the break-even point?

Problem 2



mhhe.com/stevenson14e

- Revenue = \$7 per unit
- Variable cost = \$3 per unit
- Fixed cost = \$42,000 per month
- Profit = $Q(R - v) - FC$
- Total cost = $FC + v * Q$

Solution

Volume	Total Revenue	Total VC	Fixed Cost	Total Cost	Total Profit
10,000	\$ 70,000	\$30,000	\$42,000	\$72,000	\$(2,000)
12,000	84,000	36,000	42,000	78,000	6,000
15,000	105,000	45,000	42,000	87,000	18,000

$$Q_{BEP} = \frac{FC}{R - v} = \frac{\$42,000}{\$7 - \$3} = 10,500 \text{ units per month}$$

Refer to Problem 2. Determine profit when volume equals 22,000 units.

$$\text{Profit} = Q(R - v) - FC = Q(\$7 - \$3) - \$42,000 = \$4Q - \$42,000$$

For $Q = 22,000$, profit is

$$\$4(22,000) - \$42,000 = \$46,000$$

Problem 3

Solution

A manager must decide which type of equipment to buy, Type A or Type B. Type A equipment costs \$15,000 each, and Type B costs \$11,000 each. The equipment can be operated 8 hours a day, 250 days a year.

Problem 4



mhhe.com/stevenson14e

Either machine can be used to perform two types of chemical analysis, C1 and C2. Annual service requirements and processing times are shown in the following table. Which type of equipment should be purchased, and how many of that type will be needed? The goal is to minimize total purchase cost.

Analysis Type	Annual Volume	PROCESSING TIME PER ANALYSIS (hr)	
		A	B
C1	1,200	1	2
C2	900	3	2

Solution Total processing time (Annual volume \times Processing time per analysis) needed by type of equipment:

Analysis Type	A	B
C1	1,200	2,400
C2	<u>2,700</u>	<u>1,800</u>
Total	3,900	4,200

Total processing time available per piece of equipment is 8 hours/day \times 250 days/year = 2,000. Hence, one piece can handle 2,000 hours of analysis, two pieces of equipment can handle 4,000 hours, and so on.

Given the total processing requirements, two of Type A would be needed, for a total cost of $2 \times \$15,000 = \$30,000$, or three of Type B, for a total cost of $3 \times \$11,000 = \$33,000$. Thus, two pieces of Type A would have sufficient capacity to handle the load at a lower cost than three of Type B.

Problem 5 Processes are commonly represented in either of two ways. One style uses blocks to represent operations. A similar style uses circles rather than blocks:



Process can operate in series, as shown in the preceding diagram, or in parallel, as shown here:

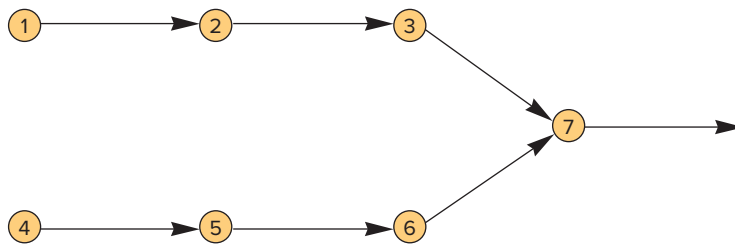

Question: What is the capacity (attainable output) of this system?

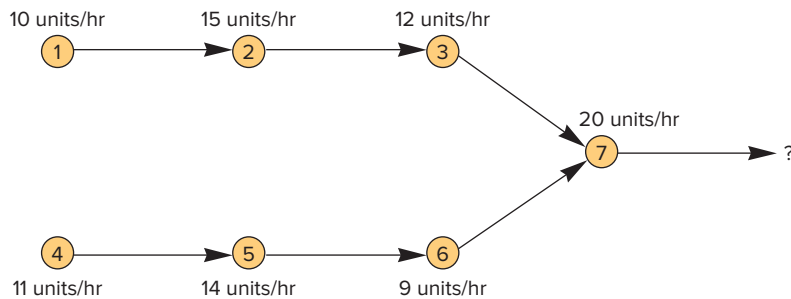

Solution The attainable output of each portion of the system is equal to the output of the slowest operation. So the output of the upper portion is 10 units per hour and the output of the lower portion is 9 units per hour. Together the two portions can produce $10 + 9 = 19$ units per hour. Although operation #7 can handle 20 units per hour, only 19 units per hour come from the two previous portions of the system, so the system output can only be 19 units per hour.

DISCUSSION AND REVIEW QUESTIONS

1. Contrast design capacity and effective capacity.
2. List and briefly explain three factors that may inhibit capacity utilization.
3. How do long-term and short-term capacity considerations differ?
4. Give an example of a good and a service that exhibit the following seasonal demand patterns.
 - a. Annual
 - b. Monthly
 - c. Weekly
 - d. Daily

5. Give some examples of building flexibility into system design.
6. Why is it important to adopt a big-picture approach to capacity planning?
7. What is meant by “capacity in chunks,” and why is that a factor in capacity planning?
8. What kinds of capacity problems do many elementary and secondary schools periodically experience? What are some alternatives to deal with those problems?
9. How can a systems approach to capacity planning be useful?
10. How do capacity decisions influence productivity?
11. Why is it important to match process capabilities with product requirements?
12. Briefly discuss how uncertainty affects capacity decisions.
13. Discuss the importance of capacity planning in deciding on the number of police officers or fire trucks to have on duty at a given time.
14. Why is capacity planning one of the most critical decisions a manager has to make?
15. Why is capacity planning for services more challenging than it is for goods production?
16. What are some capacity measures for each of the following?
 - a. University
 - b. Hospital
 - c. Computer repair shop
 - d. Farm
17. What is the benefit to a business organization of having capacity measures?

1. What are the major trade-offs in capacity planning?
2. Who needs to be involved in capacity planning?
3. In what ways does technology have an impact on capacity planning?

TAKING STOCK

1. A computer repair service has a design capacity of 80 repairs per day. Its effective capacity, however, is 64 repairs per day, and its actual output is 62 repairs per day. The manager would like to increase the number of repairs per day because demand is higher than 70 repairs per day, creating a backlog of orders. Which factors would you recommend that the manager investigate? Explain your reasoning.
2. Compared to manufacturing, service requirements tend to be more time dependent, location dependent, and volatile. In addition, service quality is often directly observable by customers. Find a recent article in a business magazine that describes how a service organization is struggling with one or more of these issues and make recommendations on what an organization needs to do to overcome these difficulties.
3. Identify four potential unethical actions or inactions related to capacity planning, and the ethical principle each violates (see Chapter 1).
4. Any increase in efficiency also increases utilization. Although the upper limit on efficiency is 100 percent, what can be done to achieve still higher levels of utilization?

CRITICAL THINKING EXERCISES

1. Determine the utilization and efficiency for each of the following situations.
 - a. A loan processing operation that processes an average of 7 loans per day. The operation has a design capacity of 10 loans per day and an effective capacity of 8 loans per day.
 - b. A furnace repair team that services an average of four furnaces a day if the design capacity is six furnaces a day and the effective capacity is five furnaces a day.
 - c. Would you say that systems that have higher efficiency ratios than other systems will always have higher utilization ratios than those other systems? Explain.
2. In a job shop, effective capacity is only 50 percent of design capacity, and actual output is 80 percent of effective capacity. What design capacity would be needed to achieve an actual output of eight jobs per week?

PROBLEMS

3. A producer of pottery is considering the addition of a new plant to absorb the backlog of demand that now exists. The primary location being considered will have fixed costs of \$9,200 per month and variable costs of 70 cents per unit produced. Each item is sold to retailers at a price that averages 90 cents.
 - a. What volume per month is required in order to break even?
 - b. What profit would be realized on a monthly volume of 61,000 units? 87,000 units?
 - c. What volume is needed to obtain a profit of \$16,000 per month?
 - d. What volume is needed to provide a revenue of \$23,000 per month?
 - e. Plot the total cost and total revenue lines.
4. A small firm intends to increase the capacity of a bottleneck operation by adding a new machine. Two alternatives, A and B, have been identified, and the associated costs and revenues have been estimated. Annual fixed costs would be \$40,000 for A and \$30,000 for B; variable costs per unit would be \$10 for A and \$11 for B; and revenue per unit would be \$15.
 - a. Determine each alternative's break-even point in units.
 - b. At what volume of output would the two alternatives yield the same profit?
 - c. If expected annual demand is 12,000 units, which alternative would yield the higher profit?
5. A producer of felt-tip pens has received a forecast of demand of 30,000 pens for the coming month from its marketing department. Fixed costs of \$25,000 per month are allocated to the felt-tip operation, and variable costs are 37 cents per pen.
 - a. Find the break-even quantity if pens sell for \$1 each.
 - b. At what price must pens be sold to obtain a monthly profit of \$15,000, assuming that estimated demand materializes?
6. A real estate agent is considering changing her land line phone plan. There are three plans to choose from, all of which involve a monthly service charge of \$20. Plan A has a cost of \$.45 a minute for daytime calls and \$.20 a minute for evening calls. Plan B has a charge of \$.55 a minute for daytime calls and \$.15 a minute for evening calls. Plan C has a flat rate of \$80 with 200 minutes of calls allowed per month and a charge of \$.40 per minute beyond that, day or evening.
 - a. Determine the total charge under each plan for this case: 120 minutes of day calls and 40 minutes of evening calls in a month.
 - b. Prepare a graph that shows total monthly cost for each plan versus daytime call minutes.
 - c. If the agent will use the service for daytime calls, over what range of call minutes will each plan be optimal?
 - d. Suppose that the agent expects both daytime and evening calls. At what point (i.e., percentage of call minutes for daytime calls) would she be indifferent between plans A and B?
7. A firm plans to begin production of a new small appliance. The manager must decide whether to purchase the motors for the appliance from a vendor at \$7 each or to produce them in-house. Either of two processes could be used for in-house production; one would have an annual fixed cost of \$160,000 and a variable cost of \$5 per unit, and the other would have an annual fixed cost of \$190,000 and a variable cost of \$4 per unit. Determine the range of annual volume for which each of the alternatives would be best.
8. A manager is trying to decide whether to purchase a certain part or to have it produced internally. Internal production could use either of two processes. One would entail a variable cost of \$17 per unit and an annual fixed cost of \$200,000; the other would entail a variable cost of \$14 per unit and an annual fixed cost of \$240,000. Three vendors are willing to provide the part. Vendor A has a price of \$20 per unit for any volume up to 30,000 units. Vendor B has a price of \$22 per unit for demand of 1,000 units or less, and \$18 per unit for larger quantities. Vendor C offers a price of \$21 per unit for the first 1,000 units, and \$19 per unit for additional units.
 - a. If the manager anticipates an annual volume of 10,000 units, which alternative would be best from a cost standpoint? For 20,000 units, which alternative would be best?
 - b. Determine the range for which each alternative is best. Are there any alternatives that are never best? Which?
9. A company manufactures a product using two machine cells. Each cell has a design capacity of 250 units per day and an effective capacity of 230 units per day. At present, actual output averages 200 units per cell, but the manager estimates that productivity improvements soon will increase output to 225 units per day. Annual demand is currently 50,000 units. It is forecasted that, within two years, annual demand will triple. How many cells should the company plan to produce to satisfy predicted demand under these conditions? Assume 240 workdays per year.

10. A company must decide which type of machine to buy, and how many units of that type, given the following information:

Type	Cost
1	\$10,000
2	14,000

Product demand and processing times for the equipment are:

Product	Annual Demand	PROCESSING TIME PER UNIT (minutes)	
		1	2
001	12,000	4	6
002	10,000	9	9
003	18,000	5	3

- How many machines of each type would be required to handle demand if the machines will operate 8 hours a day, 250 days a year, and what annual capacity cushion in processing time would result for each?
 - With high certainty of annual demand, which type of machine would be chosen if that was an important consideration? With low certainty, which type of machine would be chosen?
 - If purchasing and operating costs are taken into account, which type of machine would minimize total costs, given your answer for part *a*? Operating costs are \$6/hr for type 1 and \$5/hr for type 2.
11. A manager must decide which type of machine to buy, A, B, or C. Machine costs are as follows:

Machine	Cost
A	\$40,000
B	\$30,000
C	\$80,000

Product forecasts and processing times on the machines are as follows:

Product	Annual Demand	PROCESSING TIME PER UNIT (minutes)		
		A	B	C
1	16,000	3	4	2
2	12,000	4	4	3
3	6,000	5	6	4
4	30,000	2	2	1

- Assume that only purchasing costs are being considered. Which machine would have the lowest total cost, and how many of that machine would be needed? Machines operate 10 hours a day, 250 days a year.
 - Consider this additional information: The machines differ in terms of hourly operating costs: The A machines have an hourly operating cost of \$10 each, B machines have an hourly operating cost of \$11 each, and C machines have an hourly operating cost of \$12 each. Which alternative would be selected, and how many machines, in order to minimize total cost while satisfying capacity processing requirements?
12. A manager must decide how many machines of a certain type to purchase. Each machine can process 100 customers per day. One machine will result in a fixed cost of \$2,000 per day, while two machines will result in a fixed cost of \$3,800 per day. Variable costs will be \$20 per customer, and revenue will be \$45 per customer.
- Determine the break-even point for each range.
 - If estimated demand is 90 to 120 customers per day, how many machines should be purchased?

13. The manager of a car wash must decide whether to have one or two wash lines. One line will mean a fixed cost of \$6,000 a month, and two lines will mean a fixed cost of \$10,500 a month. Each line would be able to process 15 cars an hour. Variable costs will be \$3 per car, and revenue will be \$5.95 per car. The manager projects an average demand of between 14 and 18 cars an hour. Would you recommend one or two lines? The car wash is open 300 hours a month.
14. The following diagram shows a four-step process that begins with Operation 1 and ends with Operation 4. The rates shown in each box represent the effective capacity of that operation.
 - a. Determine the capacity of this process.
 - b. Which action would yield the greatest increase in process capacity: (1) increase the capacity of Operation 1 by 15 percent; (2) increase the capacity of Operation 2 by 10 percent; or (3) increase the capacity of Operation 3 by 10 percent?

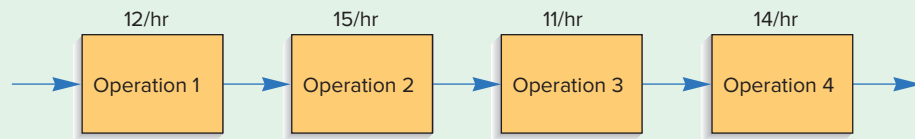

15. Given the following diagram,
 - a. What is the capacity of this system?
 - b. If the capacity of one operation could be increased in order to increase the output of the system, which operation should it be, and what amount of increase?

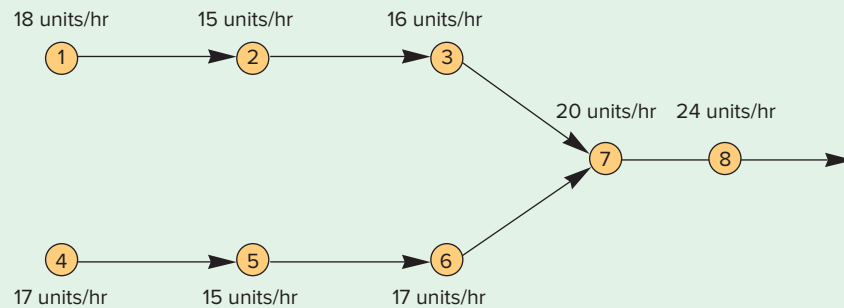

16. Find the capacity of this system:

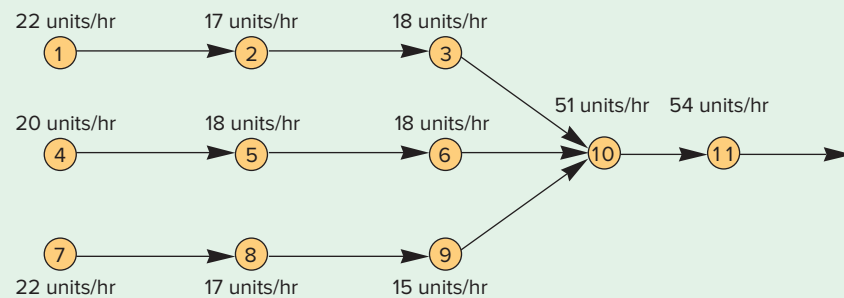

17. The following diagram describes a service process where customers go through through either of two parallel three-step processes and then merge into a single line for two final steps. Capacities of each step are shown on the diagram.
 - a. What is the current capacity of the entire system?
 - b. If you could increase the capacity of only one operation through process improvement efforts, which operation would you select, how much additional capacity would you strive for, and what would the resulting capacity of the process be?



Due to financial pressures that many hospitals face, the Deaconess Clinic in Billings, Montana, decided to outsource a number of services, although in somewhat different ways.

First, the hospital outsourced its cafeteria food service. Although the food service employees were hired by the outside firm, they still felt a sense of ownership of their jobs, and still felt connected to the hospital because of the family atmosphere in the kitchen and the cafeteria.

When the hospital tried the same thing with housekeeping, employee turnover became a problem. An investigation revealed that because the housekeeping employees were more isolated in their work, they lost what little feeling of being connected to the hospital they had. The problem was solved by hiring the employees back but using the outsource company to manage housekeeping.

The hospital also decided to outsource its laundry service. This time, the hospital approached a rival hospital about joining it in outsourcing their laundry service.

Questions

1. In some instances, the outsourced service occurs in a different location, while in others it takes place inside the organization doing the outsourcing, as the food service did in this case. What advantages were there in having the outsourced work performed within the hospital? Suppose a different hospital outsourced its food service but decided not to have the work performed in-house. What might its rationale be?
2. In the housekeeping situation, why not just forget about outsourcing, especially because the hospital ended up rehiring its employees anyway?
3. For laundry service, what might have been the rationale for asking another hospital to join it?

Source: Based on Norm Friedman, "Is Outsourcing the Solution?" www.hponline.com/inside/2004-06/outsourcing.htm

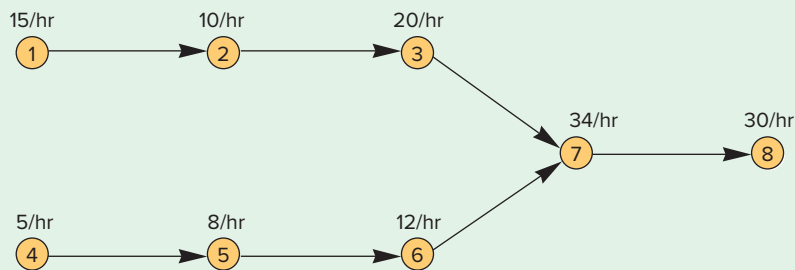

18. A new piece of equipment will cost \$12,000 and will result in a reduced operation cost of \$1,500 per year. What will the payback time be in years?
19. A new machine will cost \$18,000, but it will result in a savings of \$2,400 per year. What will the payback time be in years?
20. Remodeling an office will cost \$25,000 and will generate savings of \$3,000 the first year, \$4,000 the second year, and \$5,000 per year thereafter. How long will it take to recoup the initial cost of remodeling?

Allspaw, John. *The Art of Capacity Planning: Scaling Web Resources*. Sebastopol, CA: O'Reilly Media, 2008.

Goldratt, Eliyahu M. *Theory of Constraints*. Great Barrington, MA: North River Press, 2000.

Gunther, Neil J. *Guerrilla Capacity Planning: A Tactical Approach to Planning for Highly Scalable Applications and Services*. New York: Springer-Verlag, 2007.

Jacobs, F. Robert, William Berry, D. Clay Whybark, and Thomas Vollman. *Manufacturing Planning and Control for Supply Chain Management*. New York: McGraw-Hill, 2011.

La Piana, David. *The Nonprofit Strategy Revolution: Real Time Strategic Planning in a Rapid Response World*. St. Paul, MN: Fieldstone Alliance, 2008.

SELECTED BIBLIOGRAPHY AND FURTHER READINGS

5

Decision Theory

SUPPLEMENT

LEARNING OBJECTIVES

After completing this supplement, you should be able to:

- LO5S.1** Outline the steps in the decision process.
- LO5S.2** Name some causes of poor decisions.
- LO5S.3** Describe and use techniques that apply to decision making under uncertainty.
- LO5S.4** Describe and use the expected-value approach.
- LO5S.5** Construct a decision tree and use it to analyze a problem.
- LO5S.6** Compute the expected value of perfect information.
- LO5S.7** Conduct sensitivity analysis on a simple decision problem.

SUPPLEMENT OUTLINE

- CHAPTER 5S.1** Introduction 222
- CHAPTER 5S.2** The Decision Process and Causes of Poor Decisions 223
- CHAPTER 5S.3** Decision Environments 224
- CHAPTER 5S.4** Decision Making under Certainty 224
- CHAPTER 5S.5** Decision Making under Uncertainty 225
- CHAPTER 5S.6** Decision Making under Risk 227
- CHAPTER 5S.7** Decision Trees 227
- CHAPTER 5S.8** Expected Value of Perfect Information 229
- CHAPTER 5S.9** Sensitivity Analysis 230

5S.1 INTRODUCTION

Decision theory represents a general approach to decision making. It is suitable for a wide range of operations management decisions. Among them are capacity planning, product and service design, equipment selection, and location planning. Decisions that lend themselves to a decision theory approach tend to be characterized by the following elements:

- A set of possible future conditions that will have a bearing on the results of the decision.
- A list of alternatives for the manager to choose from.
- A known payoff for each alternative under each possible future condition.

To use this approach, a decision maker would employ this process:

1. Identify the possible future conditions (e.g., demand will be low, medium, or high; the competitor will or will not introduce a new product). These are called *states of nature*.
2. Develop a list of possible *alternatives*, one of which may be to do nothing.
3. Determine or estimate the *payoff* associated with each alternative for every possible future condition.
4. If possible, estimate the *likelihood* of each possible future condition.
5. Evaluate alternatives according to some *decision criterion* (e.g., maximize expected profit), and select the best alternative.

The information for a decision is often summarized in a **payoff table**, which shows the expected payoffs for each alternative under the various possible states of nature. These tables are helpful in choosing among alternatives because they facilitate comparison of alternatives. Consider the following payoff table, which illustrates a capacity planning problem.

Payoff table Table showing the expected payoffs for each alternative in every possible state of nature.

Alternatives	POSSIBLE FUTURE DEMAND		
	Low	Moderate	High
Small facility	\$10*	\$10	\$10
Medium facility	7	12	12
Large facility	(4)	2	16

*Present value in \$ millions.

The payoffs are shown in the body of the table. In this instance, the payoffs are in terms of present values, which represent equivalent current dollar values of expected future income less costs. This is a convenient measure because it places all alternatives on a comparable basis. If a small facility is built, the payoff will be the same for all three possible states of nature. For a medium facility, low demand will have a present value of \$7 million, whereas both moderate and high demand will have present values of \$12 million. A large facility will have a loss of \$4 million if demand is low, a present value of \$2 million if demand is moderate, and a present value of \$16 million if demand is high.

The problem for the decision maker is to select one of the alternatives, taking the present value into account.

Evaluation of the alternatives differs according to the degree of certainty associated with the possible future conditions.

5S.2 THE DECISION PROCESS AND CAUSES OF POOR DECISIONS

Despite the best efforts of a manager, a decision occasionally turns out poorly due to unforeseeable circumstances. Luckily, such occurrences are not common. Often, failures can be traced to a combination of mistakes in the decision process, to *bounded rationality*, or to *suboptimization*.

The decision process consists of these steps:

1. Identify the problem.
2. Specify objectives and criteria for a solution.
3. Develop suitable alternatives.
4. Analyze and compare alternatives.
5. Select the best alternative.
6. Implement the solution.
7. Monitor to see that the desired result is achieved.

In many cases, managers fail to appreciate the importance of each step in the decision-making process. They may skip a step or not devote enough effort to completing it before jumping to the next step. Sometimes this happens owing to a manager's style of making quick decisions or a failure to recognize the consequences of a poor decision. The manager's ego can be a factor. This sometimes happens when the manager has experienced a series of successes—important decisions that turned out right. Some managers then get the impression that they can do no wrong. But they soon run into trouble, which is usually enough to bring them back down to earth. Other managers seem oblivious to negative results and continue the process they associate with their previous successes, not recognizing that some of that success may have been due more to luck than to any special abilities of their own. A part of the

LO5S.1 Outline the steps in the decision process.

LO5S.2 Name some causes of poor decisions.

problem may be the manager's unwillingness to admit a mistake. Yet other managers demonstrate an inability to make a decision; they stall long past the time when the decision should have been rendered.

Of course, not all managers fall into these traps—it seems safe to say that the majority do not. Even so, this does not necessarily mean that every decision works out as expected. Another factor with which managers must contend is **bounded rationality**, or the limits imposed on decision making by costs, human abilities, time, technology, and the availability of information. Because of these limitations, managers cannot always expect to reach decisions that are optimal in the sense of providing the best possible outcome (e.g., highest profit, least cost). Instead, they must often resort to achieving a *satisfactory* solution.

Still another cause of poor decisions is that organizations typically departmentalize decisions. Naturally, there is a great deal of justification for the use of departments in terms of overcoming span-of-control problems and human limitations. However, **suboptimization** can occur. This is a result of different departments' attempts to reach a solution that is optimum for each. Unfortunately, what is optimal for one department may not be optimal for the organization as a whole. If you are familiar with the theory of constraints (see Chapter 16), suboptimization and local optima are conceptually the same, with the same negative consequences.

Bounded rationality The limitations on decision making caused by costs, human abilities, time, technology, and availability of information.

Suboptimization The result of different departments each attempting to reach a solution that is optimum for that department.

5S.3 DECISION ENVIRONMENTS

Operations management decision environments are classified according to the degree of certainty present. There are three basic categories: certainty, risk, and uncertainty.

Certainty Environment in which relevant parameters have known values.

Risk Environment in which certain future events have probable outcomes.

Uncertainty Environment in which it is impossible to assess the likelihood of various future events.

Certainty means that relevant parameters—such as costs, capacity, and demand—have known values.

Risk means that certain parameters have probabilistic outcomes.

Uncertainty means that it is impossible to assess the likelihood of various possible future events.

Consider these situations:

1. Profit per unit is \$5. You have an order for 200 units. How much profit will you make? (This is an example of *certainty* because unit profits and total demand are known.)
2. Profit is \$5 per unit. Based on previous experience, there is a 50 percent chance of an order for 100 units and a 50 percent chance of an order for 200 units. What is expected profit? (This is an example of *risk* because demand outcomes are probabilistic.)
3. Profit is \$5 per unit. The probabilities of potential demands are unknown. (This is an example of *uncertainty*.)

The importance of these different decision environments is that they require different analysis techniques. Some techniques are better suited for one category than for others.

5S.4 DECISION MAKING UNDER CERTAINTY

When it is known for certain which of the possible future conditions will actually happen, the decision is usually relatively straightforward: Simply choose the alternative that has the best payoff under that state of nature. Example 5S-1 illustrates this.

EXAMPLE 5S-1

Choosing an Alternative under Certainty

Determine the best alternative in the payoff table on the previous page for each of the cases: It is known with certainty that demand will be (a) low, (b) moderate, (c) high.

Choose the alternative with the highest payoff. Thus, if we know demand will be low, we would elect to build the small facility and realize a payoff of \$10 million. If we know demand will be moderate, a medium factory would yield the highest payoff (\$12 million versus either \$10 million or \$2 million). For high demand, a large facility would provide the highest payoff.

Although complete certainty is rare in such situations, this kind of exercise provides some perspective on the analysis. Moreover, in some instances, there may be an opportunity to consider allocation of funds to research efforts, which may reduce or remove some of the uncertainty surrounding the states of nature, converting uncertainty to risk or to certainty.

SOLUTION

5S.5 DECISION MAKING UNDER UNCERTAINTY

At the opposite extreme is complete uncertainty: No information is available on how likely the various states of nature are. Under those conditions, four possible decision criteria are *maximin*, *maximax*, *Laplace*, and *minimax regret*. These approaches can be defined as follows:

Maximin—Determine the worst possible payoff for each alternative, and choose the alternative that has the “best worst.” The maximin approach is essentially a pessimistic one because it takes into account only the worst possible outcome for each alternative. The actual outcome may not be as bad as that, but this approach establishes a “guaranteed minimum.”

Maximax—Determine the best possible payoff, and choose the alternative with that payoff. The maximax approach is an optimistic, “go for it” strategy; it does not take into account any payoff other than the best.

Laplace—Determine the average payoff for each alternative, and choose the alternative with the best average. The Laplace approach treats the states of nature as equally likely.

Minimax regret—Determine the worst *regret* for each alternative, and choose the alternative with the “best worst.” This approach seeks to minimize the difference between the payoff that is realized and the best payoff for each state of nature.

The next two examples illustrate these decision criteria.

LO5S.3 Describe and use techniques that apply to decision making under uncertainty.

Maximin Choose the alternative with the best of the worst possible payoffs.

Maximax Choose the alternative with the best possible payoff.

Laplace Choose the alternative with the best average payoff of any of the alternatives.

Minimax regret Choose the alternative that has the least of the worst regrets.

Choosing an Alternative Using Maximax, Maximin, and Laplace

Referring to the payoff table in the Introduction, determine which alternative would be chosen under each of the following strategies.

- Maximin
- Maximax
- Laplace

EXAMPLE 5S-2

Excel
mhhe.com/stevenson14e

- Using maximin, the worst payoffs for the alternatives are as follows:

Small facility:	\$10 million
Medium facility:	7 million
Large facility:	−4 million

Hence, because \$10 million is the best, choose to build the small facility using the maximin strategy.

SOLUTION

b. Using maximax, the best payoffs are as follows:

Small facility: \$10 million

Medium facility: 12 million

Large facility: 16 million

The best overall payoff is the \$16 million in the third row. Hence, the maximax criterion leads to building a large facility.

c. For the Laplace criterion, first find the row totals, and then divide each of those amounts by the number of states of nature (three in this case). Thus, we have

	Row Total (in \$ millions)	Row Average (in \$ millions)
Small facility	\$30	\$10.00
Medium facility	31	10.33
Large facility	14	4.67

Because the medium facility has the highest average, it would be chosen under the Laplace criterion.

EXAMPLE 5S-3

Choosing an Alternative Using Minimax Regret

Determine which alternative would be chosen using a minimax regret approach to the capacity planning program.

SOLUTION

Regret (opportunity loss)

The difference between a given payoff and the best payoff for a state of nature.

The first step in this approach is to prepare a table of **regrets (opportunity losses)**. To do this, subtract every payoff *in each column* from the best payoff in that column. For instance, in the first column, the best payoff is 10, so each of the three numbers in that column must be subtracted from 10. Going down the column, the regrets will be $10 - 10 = 0$, $10 - 7 = 3$, and $10 - (-4) = 14$. In the second column, the best payoff is 12. Subtracting each payoff from 12 yields 2, 0, and 10. In the third column, 16 is the best payoff. The regrets are 6, 4, and 0. These results are summarized in a regret table:

Alternatives	REGRETS (IN \$ MILLIONS)			
	Low	Moderate	High	Worst
Small facility	\$0	\$2	\$6	\$6
Medium facility	3	0	4	4
Large facility	14	10	0	14

The second step is to identify the worst regret for each alternative. For the first alternative, the worst is 6; for the second, the worst is 4; and for the third, the worst is 14.

The best of these worst regrets would be chosen using minimax regret. The lowest regret is 4, which is for a medium facility. Hence, that alternative would be chosen.

Solved Problem 6 at the end of this supplement illustrates decision making under uncertainty when the payoffs represent costs.

The main weakness of these approaches (except for Laplace) is that they do not take into account *all* of the payoffs. Instead, they focus on the worst or best, and so they lose some information. Still, for a given set of circumstances, each has certain merits that can be helpful to a decision maker.

5S.6 DECISION MAKING UNDER RISK

Between the two extremes of certainty and uncertainty lies the case of risk: The probability of occurrence for each state of nature is known. (Note that because the states are mutually exclusive and collectively exhaustive, these probabilities must add to 1.00.) A widely used approach under such circumstances is the *expected monetary value criterion*. The expected value is computed for each alternative, and the one with the best expected value is selected. The expected value is the sum of the payoffs for an alternative where each payoff is *weighted* by the probability for the relevant state of nature. Thus, the approach is:

Expected monetary value (EMV) criterion—Determine the expected payoff of each alternative, and choose the alternative that has the best expected payoff.

LO5S.4 Describe and use the expected-value approach.

Expected monetary value (EMV) criterion The best expected value among the alternatives.

Choosing an Alternative Using Expected Value

Using the expected monetary value criterion, identify the best alternative for the previous payoff table for these probabilities: low = .30, moderate = .50, and high = .20.

EXAMPLE 5S-4

Find the expected value of each alternative by multiplying the probability of occurrence for each state of nature by the payoff for that state of nature and summing them:

$$\begin{aligned}EV_{\text{small}} &= .30(\$10) + .50(\$10) + .20(\$10) = \$10 \\EV_{\text{medium}} &= .30(\$7) + .50(\$12) + .20(\$12) = \$10.5 \\EV_{\text{large}} &= .30(-\$4) + .50(\$2) + .20(\$16) = \$5\end{aligned}$$

Hence, choose the medium facility because it has the highest expected value.

SOLUTION

excel

mhhe.com/stevenson14e

The expected monetary value approach is most appropriate when a decision maker is neither risk averse nor risk seeking, but is risk neutral. Typically, well-established organizations with numerous decisions of this nature tend to use expected value because it provides an indication of the long-run, average payoff. That is, the expected-value amount (e.g., \$10.5 million in the last example) is not an actual payoff but an expected or average amount that would be approximated if a large number of identical decisions were to be made. Hence, if a decision maker applies this criterion to a large number of similar decisions, the expected payoff for the total will approximate the sum of the individual expected payoffs.

5S.7 DECISION TREES

In health care, the array of treatment options and medical costs makes tools such as decision trees particularly valuable in diagnosing and prescribing treatment plans. For example, if a 20-year-old and a 50-year-old both are brought into an emergency room complaining of chest pains, the attending physician, after asking each some questions on family history, patient history, general health, and recent events and activities, will use a *decision tree* to sort through the options to arrive at the appropriate decision for each patient.

Decision trees are tools that have many practical applications, not only in health care but also in legal cases and a wide array of management decision making, including credit card fraud; loan, credit, and insurance risk analysis; decisions on new product or service development; and location analysis.

A **decision tree** is a schematic representation of the alternatives available to a decision maker and their possible consequences. The term gets its name from the treelike appearance of the diagram (see Figure 5S.1). Although tree diagrams can be used in place of a payoff table, they are particularly useful for analyzing situations that involve *sequential* decisions.

LO5S.5 Construct a decision tree and use it to analyze a problem.

Decision tree A schematic representation of the available alternatives and their possible consequences.

FIGURE 5S.1

Format of a decision tree

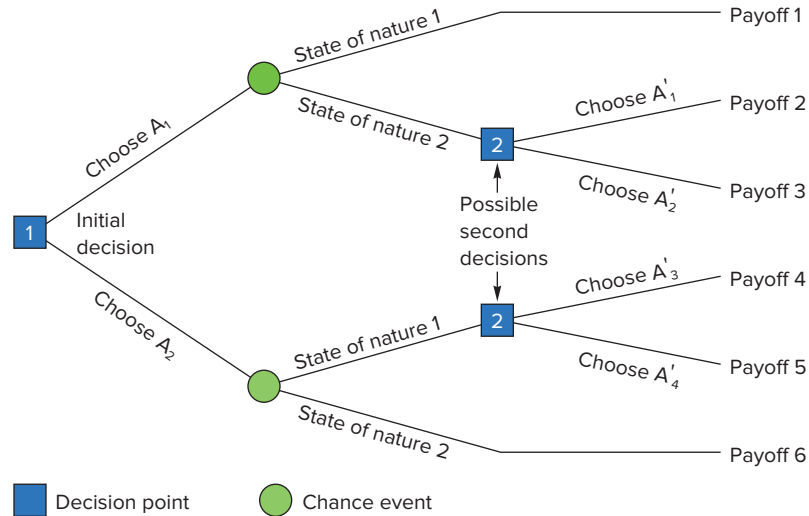

For instance, a manager may initially decide to build a small facility only to discover that demand is much higher than anticipated. In this case, the manager may then be called upon to make a subsequent decision on whether to expand or build an additional facility.

A decision tree is composed of a number of *nodes* that have *branches* emanating from them (see Figure 5S.1). Square nodes denote decision points, and circular nodes denote chance events. Read the tree from left to right. Branches leaving square nodes represent alternatives; branches leaving circular nodes represent chance events (i.e., the possible states of nature).

After the tree has been drawn, it is analyzed from *right to left*; that is, starting with the last decision that might be made. For each decision, choose the alternative that will yield the greatest return (or the lowest cost). If chance events follow a decision, choose the alternative that has the highest expected monetary value (or lowest expected cost).

EXAMPLE 5S-5



Choosing an Alternative Using Expected Value with a Decision Tree

A manager must decide on the size of a video arcade to construct. The manager has narrowed the choices to two: large or small. Information has been collected on payoffs, and a decision tree has been constructed. Analyze the decision tree and determine which initial alternative (build small or build large) should be chosen in order to maximize expected monetary value.

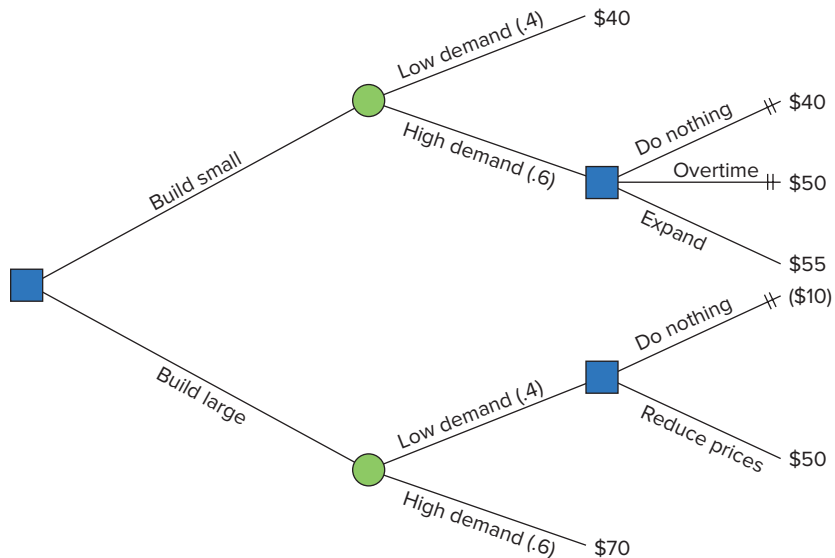

SOLUTION

The dollar amounts at the branch ends indicate the estimated payoffs if the sequence of chance events and decisions that is traced back to the initial decision occurs. For example, if the initial decision is to build a small facility and it turns out that demand is low, the payoff will be \$40 (thousand). Similarly, if a small facility is built, demand turns out to be high, and a later decision is made to expand, the payoff will be \$55 (thousand). The figures in parentheses on branches leaving the chance nodes indicate the probabilities of those states of nature. Hence, the probability of low demand is .4, and the probability of high demand is .6. Payoffs in parentheses indicate losses.

Analyze the decisions from right to left:

1. Determine which alternative would be selected for each possible second decision. For a small facility with high demand, there are three choices: *do nothing*, *work overtime*, and *expand*. Because *expand* has the highest payoff, you would choose it. Indicate this by placing a double slash through each of the other alternatives. Similarly, for a large facility with low demand, there are two choices: *do nothing* and *reduce prices*. You would choose *reduce prices* because it has the higher expected value, so a double slash is placed on the other branch.
2. Determine the product of the chance probabilities and their respective payoffs for the remaining branches:

Build small	
Low demand	.4(\$40) = \$16
High demand	.6(\$55) = <u>\$33</u>
	\$49

Build large	
Low demand	.4(\$50) = \$20
High demand	.6(\$70) = <u>\$42</u>
	\$62

3. Hence, the choice should be to build the large facility because it has a larger expected value than the small facility.

5S.8 EXPECTED VALUE OF PERFECT INFORMATION

In certain situations, it is possible to ascertain which state of nature will actually occur in the future. For instance, the choice of location for a restaurant may weigh heavily on whether a new highway will be constructed or whether a zoning permit will be issued. A decision maker may have probabilities for these states of nature; however, it may be possible to delay a decision until it is clear which state of nature will occur. This might involve taking an option to buy the land. If the state of nature is favorable, the option can be exercised; if it is unfavorable, the option can be allowed to expire. The question to consider is whether the cost of the option will be less than the expected gain due to delaying the decision (i.e., the expected payoff *above* the expected value). The expected gain is the **expected value of perfect information (EVPI)**.

Other possible ways of obtaining perfect information depend somewhat on the nature of the decision being made. Information about consumer preferences might come from market research, additional information about a product could come from product testing, or legal experts might be called on.

There are two ways to determine the EVPI. One is to compute the expected payoff under certainty and subtract the expected payoff under risk. That is,

$$\text{Expected value of perfect information} = \text{Expected payoff under certainty} - \text{Expected payoff under risk} \quad (5S-1)$$

LO5S.6 Compute the expected value of perfect information.

Expected value of perfect information (EVPI) The difference between the expected payoff with perfect information and the expected payoff under risk.

EXAMPLE 5S-6**Computing the Expected Value of Perfect Information Using Formula 5S-1**

Using the information from Example 5S-4, determine the expected value of perfect information using Formula 5S-1.

SOLUTION

First, compute the expected payoff under certainty. To do this, identify the best payoff under each state of nature. Then, combine these by weighting each payoff by the probability of that state of nature and adding the amounts. Thus, the best payoff under low demand is \$10, the best under moderate demand is \$12, and the best under high demand is \$16. The expected payoff under certainty is then

$$.30(\$10) + .50(\$12) + .20(\$16) = \$12.2$$

The expected payoff under risk, as computed in Example 5S-4, is \$10.5. The EVPI is the difference between these:

$$\text{EVPI} = \$12.2 - \$10.5 = \$1.7$$

This figure indicates the upper limit on the amount the decision maker should be willing to spend to obtain perfect information in this case. Thus, if the cost equals or exceeds this amount, the decision maker would be better off not spending additional money and simply going with the alternative that has the highest expected payoff.

A second approach is to use the regret table to compute the EVPI. To do this, find the expected regret for each alternative. The minimum expected regret is equal to the EVPI.

EXAMPLE 5S-7**Computing the Expected Value of Perfect Information Using Expected Regret**

Determine the expected value of perfect information for the capacity-planning problem using the expected regret approach.

SOLUTION

Using information from Examples 5S-2, 5S-3, and 5S-4, we can compute the expected regret for each alternative. Thus:

$$\text{Small facility} \quad .30(0) + .50(2) + .20(6) = 2.2$$

$$\text{Medium facility} \quad .30(3) + .50(0) + .20(4) = 1.7 \text{ [minimum]}$$

$$\text{Large facility} \quad .30(14) + .50(10) + .20(0) = 9.2$$

The lowest expected regret is 1.7, which is associated with the second alternative. Hence, the EVPI is \$1.7 million, which agrees with the previous example using the other approach.

5S.9 SENSITIVITY ANALYSIS

LO5S.7 Conduct sensitivity analysis on a simple decision problem.

Sensitivity analysis Determining the range of probability for which an alternative has the best expected payoff.

Generally speaking, both the payoffs and the probabilities in this kind of a decision problem are estimated values. Consequently, it can be useful for the decision maker to have some indication of how sensitive the choice of an alternative is to changes in one or more of these values. Unfortunately, it is impossible to consider all possible combinations of every variable in a typical problem. Nevertheless, there are certain things a decision maker can do to judge the sensitivity of probability estimates.

Sensitivity analysis provides a range of probability over which the choice of alternatives would remain the same. The approach illustrated here is useful when there are

two states of nature. It involves constructing a graph and then using algebra to determine a range of probabilities for which a given solution is best. In effect, the graph provides a visual indication of the range of probability over which the various alternatives are optimal, and the algebra provides exact values of the endpoints of the ranges. Example 5S-8 illustrates the procedure.

Finding Optimal Probability Ranges for the Expected Value Approach

Given the following table, determine the range of probability for state of nature #2—that is, $P(2)$, for which each alternative is optimal under the expected-value approach.

	STATE OF NATURE	
	#1	#2
Alternative A	4	12
Alternative B	16	2
Alternative C	12	8

EXAMPLE 5S-8

excel
mhhe.com/stevenson14e

First, plot each alternative relative to $P(2)$. To do this, plot the #1 value on the left side of the graph and the #2 value on the right side. For instance, for alternative A, plot 4 on the left side of the graph and 12 on the right side. Then, connect these two points with a straight line. The three alternatives are plotted on the graph below.

SOLUTION

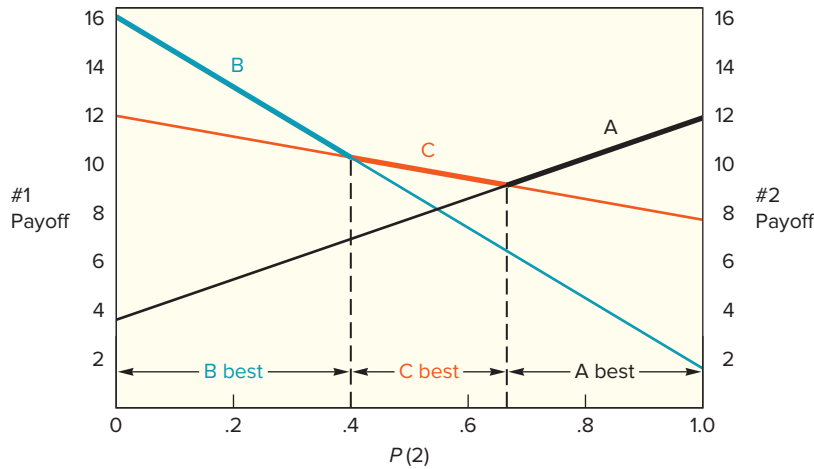

The graph shows the range of values of $P(2)$ over which each alternative is optimal. Thus, for low values of $P(2)$ [and thus high values of $P(1)$, since $P(1) + P(2) = 1.0$], alternative B will have the highest expected value; for intermediate values of $P(2)$, alternative C is best; and for higher values of $P(2)$, alternative A is best.

To find exact values of the ranges, determine where the upper parts of the lines intersect. Note that at the intersections, the two alternatives represented by the lines would be equivalent in terms of expected value. Hence, the decision maker would be indifferent between the two at that point. To determine the intersections, you must obtain the equation of each line. This is relatively simple to do. Because these are straight lines, they have the form $y = a + bx$, where a is the y -intercept value at the left axis, b is the slope of the line, and x is $P(2)$. Slope is defined as the change in y for a one-unit change in x . In this type of

problem, the distance between the two vertical axes is 1.0. Consequently, the slope of each line is equal to the right-hand value minus the left-hand value. The slopes and equations are as follows:

	#1	#2	Slope	Equation
A	4	12	$12 - 4 = +8$	$4 + 8P(2)$
B	16	2	$2 - 16 = -14$	$16 - 14P(2)$
C	12	8	$8 - 12 = -4$	$12 - 4P(2)$

From the graph, we can see that alternative B is best from $P(2) = 0$ to the point where that straight line intersects the straight line of alternative C, and that begins the region where C is better. To find that point, solve for the value of $P(2)$ at their intersection. This requires setting the two equations equal to each other and solving for $P(2)$. Thus,

$$16 - 14P(2) = 12 - 4P(2)$$

Rearranging terms yields

$$4 = 10P(2)$$

Solving yields $P(2) = .40$. Thus, alternative B is best from $P(2) = 0$ up to $P(2) = .40$. B and C are equivalent at $P(2) = .40$.

Alternative C is best from that point until its line intersects alternative A's line. To find that intersection, set those two equations equal and solve for $P(2)$. Thus,

$$4 + 8P(2) = 12 - 4P(2)$$

Rearranging terms results in

$$12P(2) = 8$$

Solving yields $P(2) = .67$. Thus, alternative C is best from $P(2) > .40$ up to $P(2) = .67$, where A and C are equivalent. For values of $P(2)$ greater than .67 up to $P(2) = 1.0$, A is best.

Note: If a problem calls for ranges with respect to $P(1)$, find the $P(2)$ ranges as above, and then subtract each $P(2)$ from 1.00 (e.g., .40 becomes .60, and .67 becomes .33).

SUMMARY

Decision making is an integral part of operations management.

Decision theory is a general approach to decision making that is useful in many different aspects of operations management. Decision theory provides a framework for the analysis of decisions. It includes a number of techniques that can be classified according to the degree of uncertainty associated with a particular decision problem. Two visual tools useful for analyzing some decision problems are decision trees and graphical sensitivity analysis.

KEY TERMS

bounded rationality, 224
 certainty, 224
 decision tree, 227
 expected monetary value (EMV) criterion, 227
 expected value of perfect information (EVPI), 229

Laplace, 225
 maximax, 225
 maximin, 225
 minimax regret, 225
 payoff table, 223

regrets (opportunity loss), 226
 risk, 224
 sensitivity analysis, 230
 suboptimization, 224
 uncertainty, 224

SOLVED PROBLEMS

The following solved problems refer to this payoff table:

		New Bridge Built	No New Bridge
Alternative capacity for new store	A	1	14
	B	2	10
	C	4	6

where A = small, B = medium, and C = large.

Assume the payoffs represent profits. Determine the alternative that would be chosen under each of the following decision criteria.

- a. Maximin
- b. Maximax
- c. Laplace

Problem 1



	New Bridge	No New Bridge	Maximin (worst)	Maximax (best)	Laplace (average)
A	1	14	1	14 [best]	$15 \div 2 = 7.5$ [best]
B	2	10	2	10	$12 \div 2 = 6$
C	4	6	4 [best]	6	$10 \div 2 = 5$

Solution

Thus, the alternatives chosen would be C under maximin, A under maximax, and A under Laplace.

Using graphical sensitivity analysis, determine the probability for no new bridge for which each alternative would be optimal.

Problem 2



Plot a straight line for each alternative. Do this by plotting the payoff for new bridge on the left axis and the payoff for no new bridge on the right axis and then connecting the two points. Each line represents the expected profit for an alternative for the entire range of probability of no new bridge. Because the lines represent expected profit, the line that is highest for a given value of P (no new bridge) is optimal. Thus, from the graph, you can see that for low values of this probability, alternative C is best, and for higher values, alternative A is best (B is never the highest line, so it is never optimal).

Solution

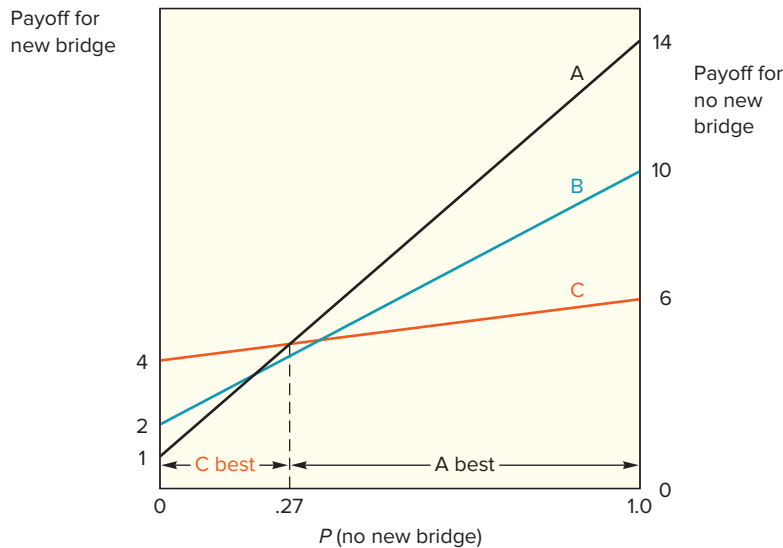

The dividing line between the ranges where C and A are optimal occurs where the two lines intersect. To find that probability, first formulate the equation for each line. To do this, let the intersection with the left axis be the y intercept; the slope equals the right-side payoff minus the left-side payoff. Thus, for C you have $4 + (6 - 4)P$, which is $4 + 2P$. For A, $1 + (14 - 1)P$, which is $1 + 13P$. Setting these two equal to each other, you can solve for P :

$$4 + 2P = 1 + 13P$$

Solving, $P = .27$. Therefore, the ranges for P (no new bridge) are

- A: $.27 < P \leq 1.00$
- B: never optimal
- C: $0 \leq P < .27$

Problem 3



mhhe.com/stevenson14e

Using the information in the payoff table, develop a table of regrets, and then:

- a. Determine the alternative that would be chosen under minimax regret.
- b. Determine the expected value of perfect information using the regret table, assuming that the probability of a new bridge being built is .60.

Solution

To obtain the regrets, subtract all payoffs in each column from the best payoff in the column. The regrets are

	New Bridge	No New Bridge
A	3	0
B	2	4
C	0	8

- a. Minimax regret involves finding the worst regret for each alternative and then choosing the alternative that has the “best” worst. Thus, you would choose A:

	Worst
A	3 [best]
B	4
C	8

- b. Once the regret table has been developed, you can compute the EVPI as the *smallest* expected regret. Because the probability of a new bridge is given as .60, we can deduce that the probability of no new bridge is $1.00 - .60 = .40$. The expected regrets are

A: $.60(3) + .40(0) = 1.80$

B: $.60(2) + .40(4) = 2.80$

C: $.60(0) + .40(8) = 3.20$

Hence, the EVPI is 1.80.

Problem 4



mhhe.com/stevenson14e

Using the probabilities of .60 for a new bridge and .40 for no new bridge:

- a. Compute the expected value of each alternative in the payoff table, and identify the alternative that would be selected under the expected-value approach.
- b. Construct a decision tree for the problem showing expected values.

Solution

a. A: $.60(1) + .40(14) = 6.20$ [best]

B: $.60(2) + .40(10) = 5.20$

C: $.60(4) + .40(6) = 4.80$

b.

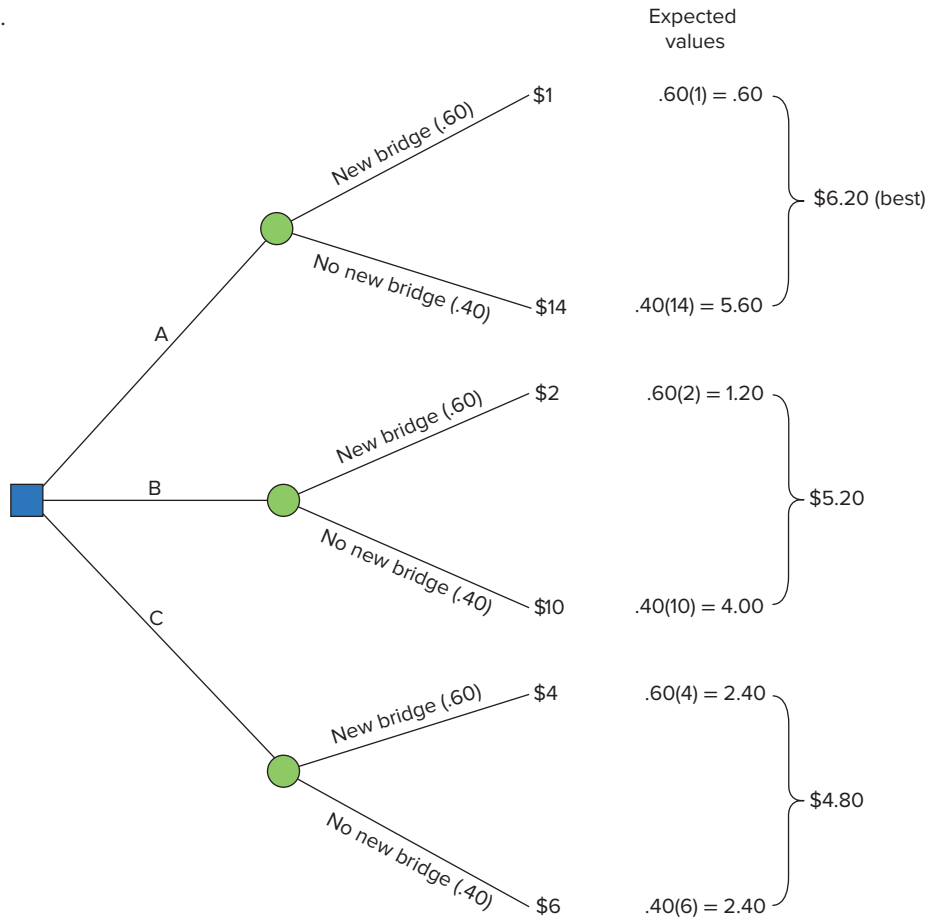

Compute the EVPI using the information from the previous problem.

Problem 5

Using Formula 5S-1, the EVPI is the expected payoff under certainty minus the maximum expected value. The expected payoff under certainty involves multiplying the best payoff in each column by the column probability and then summing those amounts. The best payoff in the first column is 4, and the best in the second is 14. Thus,

Solution

$$\text{Expected payoff under certainty} = .60(4) + .40(14) = 8.00$$

Then

$$\text{EVP} = 8.00 - 6.20 = 1.80$$

(This agrees with the result obtained in Solved Problem 3b.)

Excel solution:

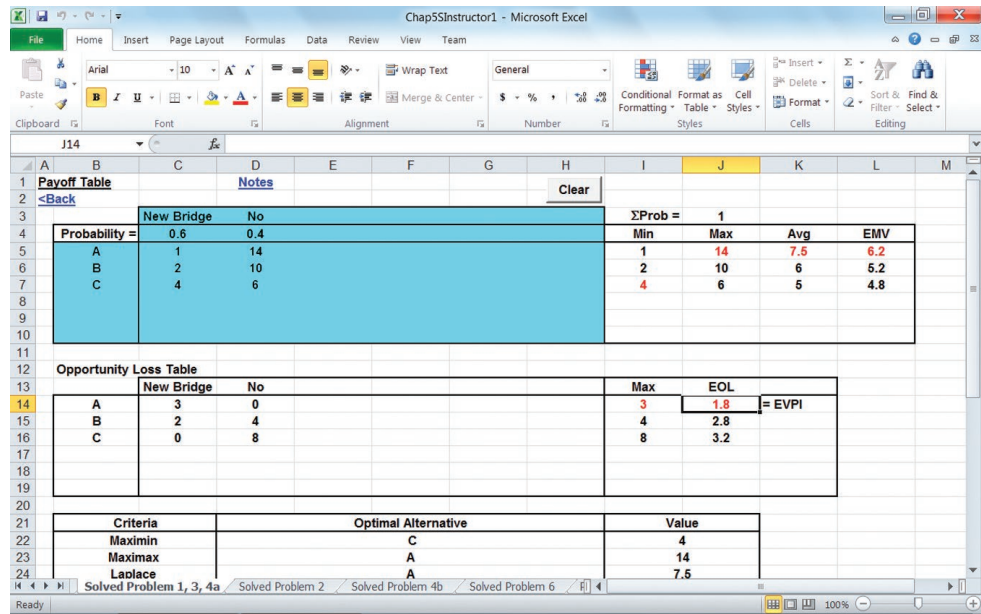

Source: Microsoft

Placing the problem data in the cell positions shown, the expected monetary value (EMV) for each alternative is shown in column J.

Then, the overall EMV is obtained in column L as the maximum of the values in L5, L6, and L7.

The EVPI is obtained using the Opportunity Loss Table as the minimum EOL value in J14, J15, and J16.

Problem 6

 mhhe.com/stevenson14e

Suppose that the values in the payoff table represent *costs* instead of profits.

- Determine the choice you would make under each of these strategies: maximin, minimin, and Laplace.*
- Develop the regret table, and identify the alternative chosen using minimax regret. Then, find the EVPI if $P(\text{new bridge}) = .60$.
- Using sensitivity analysis, determine the range of $P(\text{no new bridge})$ for which each alternative would be optimal.
- If $P(\text{new bridge}) = .60$ and $P(\text{no new bridge}) = .40$, find the alternative chosen to minimize expected cost.

Solution

a.

	New Bridge	No New Bridge	Maximin (worst)	Minimin (best)	Laplace (average)
A	1	14	14	1 [best]	$15 \div 2 = 7.5$
B	2	10	10	2	$12 \div 2 = 6$
C	4	6	6 [best]	4	$10 \div 2 = 5$ [best]

*Minimin is the reverse of maximax; for costs, minimin identifies the lowest (best) cost.

- b. Develop the regret table by subtracting the *lowest cost* in each column from each of the values in the column. (Note that none of the values is negative.)

	New Bridge	No New Bridge	Worst
A	0	8	8
B	1	4	4
C	3	0	3 [best]

$$EVPI = .60(3) + .40(0) = 1.80$$

- c. The graph is identical to that shown in Solved Problem 2. However, the lines now represent expected *costs*, so the best alternative for a given value of P (no new bridge) is the *lowest* line. Hence, for very low values of P (no new bridge), A is best; for intermediate values, B is best; and for high values, C is best. You can set the equations of A and B, and B and C, equal to each other in order to determine the values of P (no new bridge) at their intersections. Thus,

$$A = B: 1 + 13P = 2 + 8P; \text{ solving, } P = .20$$

$$B = C: 2 + 8P = 4 + 2P; \text{ solving, } P = .33$$

Hence, the ranges are

$$A \text{ best: } 0 \leq P < .20$$

$$B \text{ best: } .20 < P < .33$$

$$C \text{ best: } .33 < P \leq 1.00$$

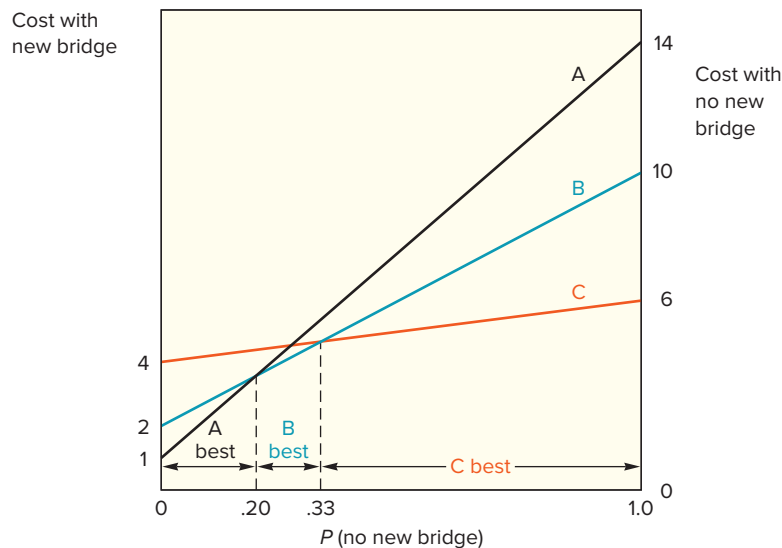

- d. Expected-value computations are the same whether the values represent costs or profits. Hence, the expected payoffs for costs are the same as the expected payoffs for profits that were computed in Solved Problem 4. However, now you want the alternative that has the *lowest* expected payoff rather than the one with the highest payoff. Consequently, alternative C is the best because its expected payoff is the lowest of the three. Alternatively, the best choice (C) could be determined using the sensitivity ranges found in part c because .40 lies in the range .33 to 1.0.

DISCUSSION AND REVIEW QUESTIONS

1. What is the chief role of the operations manager?
2. List the steps in the decision-making process.
3. Explain the term *bounded rationality*.
4. Explain the term *suboptimization*.
5. What are some of the reasons for poor decisions?
6. What information is contained in a payoff table?
7. What is sensitivity analysis, and how can it be useful to a decision maker?
8. Contrast maximax and maximin decision strategies. Under what circumstances is each appropriate?
9. Under what circumstances is expected monetary value appropriate as a decision criterion? When isn't it appropriate?
10. Explain or define each of the following terms.
 - a. Laplace criterion
 - b. Minimax regret
 - c. Expected value
 - d. Expected value of perfect information
11. What information does a decision maker need in order to perform an expected-value analysis of a problem? What options are available to the decision maker if the probabilities of the states of nature are unknown? Can you think of a way you might use sensitivity analysis in such a case?
12. Suppose a manager is using maximum EMV as a basis for making a capacity decision and, in the process, obtains a result in which there is a virtual tie between two of the seven alternatives. How is the manager to make a decision?
13. Identify three potential unethical actions or inactions related to decision analysis and the ethical principle each violates (see Chapter 1).

PROBLEMS

1. A small building contractor has recently experienced two successive years in which work opportunities exceeded the firm's capacity. The contractor must now make a decision on capacity for next year. Estimated profits under each of the two possible states of nature are as shown in the table below. Which alternative should be selected if the decision criterion is:
 - a. Maximax?
 - b. Maximin?
 - c. Laplace?
 - d. Minimax regret?

Alternative	NEXT YEAR'S DEMAND	
	Low	High
Do nothing	\$50*	\$60
Expand	20	80
Subcontract	40	70

*Profit in \$ thousands.

2. Refer to Problem 1. Suppose after a certain amount of discussion, the contractor is able to subjectively assess the probabilities of low and high demand: $P(\text{low}) = .3$ and $P(\text{high}) = .7$.
 - a. Determine the expected profit of each alternative. Which alternative is best? Why?
 - b. Analyze the problem using a decision tree. Show the expected profit of each alternative on the tree.
 - c. Compute the expected value of perfect information. How could the contractor use this knowledge?
3. Refer to Problems 1 and 2. Construct a graph that will enable you to perform sensitivity analysis on the problem. Over what range of $P(\text{high})$ would the alternative of doing nothing be best? Expand? Subcontract?

4. A firm that plans to expand its product line must decide whether to build a small or a large facility to produce the new products. If it builds a small facility and demand is low, the net present value after deducting for building costs will be \$400,000. If demand is high, the firm can either maintain the small facility or expand it. Expansion would have a net present value of \$450,000, and maintaining the small facility would have a net present value of \$50,000.

If a large facility is built and demand is high, the estimated net present value is \$800,000. If demand turns out to be low, the net present value will be -\$10,000.

The probability that demand will be high is estimated to be .60, and the probability of low demand is estimated to be .40.

 - a. Analyze using a tree diagram.
 - b. Compute the EVPI. How could this information be used?
 - c. Determine the range over which each alternative would be best in terms of the value of P (demand low).
5. Determine the course of action that has the highest expected payoff for this decision tree.

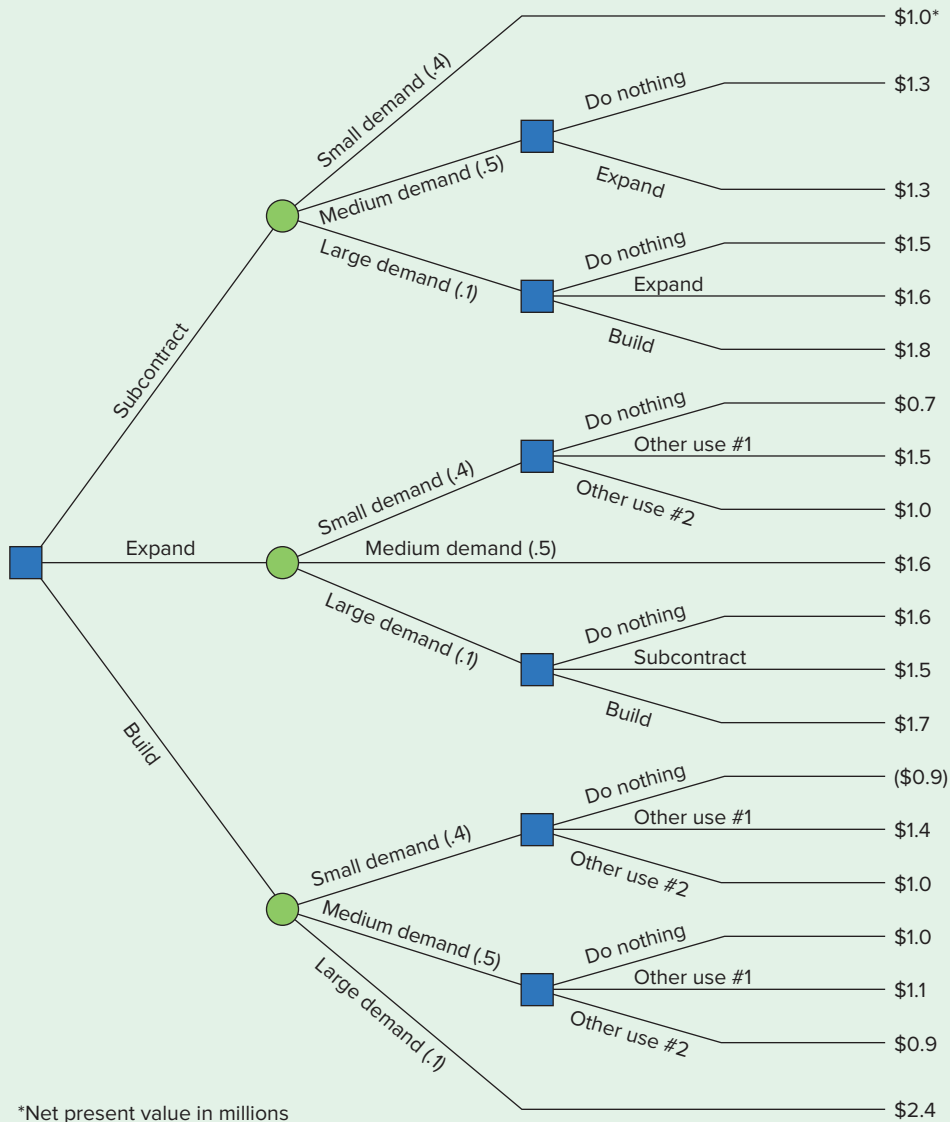

6. The lease of Theme Park, Inc., is about to expire. Management must decide whether to renew the lease for another 10 years or to relocate near the site of a proposed motel. The town planning board is currently debating the merits of granting approval to the motel. A consultant has estimated the net present value of Theme Park's two alternatives under each state of nature as shown on the following page.

What course of action would you recommend using?

- a. Maximax
- b. Maximin
- c. Laplace
- d. Minimax regret

Options	Motel Approved	Motel Rejected
Renew	\$ 500,000	\$4,000,000
Relocate	5,000,000	100,000

7. Refer to Problem 6. Suppose that the management of Theme Park, Inc., has decided that there is a .35 probability that the motel's application will be approved.
 - a. If management uses maximum expected monetary value as the decision criterion, which alternative should it choose?
 - b. Represent this problem in the form of a decision tree.
 - c. If management has been offered the option of a temporary lease while the town planning board considers the motel's application, would you advise management to sign the lease? The lease will cost \$24,000.
8. Construct a graph that can be used for sensitivity analysis for the preceding problem.
 - a. How sensitive is the solution to the problem in terms of the probability estimate of .35?
 - b. Suppose that, after consulting with a member of the town planning board, management decides that an estimate of approval is approximately .45. How sensitive is the solution to this revised estimate? Explain.
 - c. Suppose the management is confident of all the estimated payoffs except for \$4 million. If the probability of approval is .35, for what range of payoff for renew/reject will the alternative selected using the maximum expected value remain the same?
9. A firm must decide whether to construct a small, medium, or large stamping plant. A consultant's report indicates a .20 probability that demand will be low and an .80 probability that demand will be high.

If the firm builds a small facility and demand turns out to be low, the net present value will be \$42 million. If demand turns out to be high, the firm can either subcontract and realize the net present value of \$42 million or expand greatly for a net present value of \$48 million.

The firm could build a medium-size facility as a hedge: If demand turns out to be low, its net present value is estimated at \$22 million; if demand turns out to be high, the firm could do nothing and realize a net present value of \$46 million, or it could expand and realize a net present value of \$50 million.

If the firm builds a large facility and demand is low, the net present value will be -\$20 million, whereas high demand will result in a net present value of \$72 million.

 - a. Analyze this problem using a decision tree.
 - b. What is the maximin alternative?
 - c. Compute the EVPI and interpret it.
 - d. Perform sensitivity analysis on $P(\text{high})$.
10. A manager must decide how many machines of a certain type to buy. The machines will be used to manufacture a new gear for which there is increased demand. The manager has narrowed the decision to two alternatives: buy one machine or buy two. If only one machine is purchased and demand is more than it can handle, a second machine can be purchased at a later time. However, the cost per machine would be lower if the two machines were purchased at the same time.

The estimated probability of low demand is .30, and the estimated probability of high demand is .70.

The net present value associated with the purchase of two machines initially is \$75,000 if demand is low and \$130,000 if demand is high.

The net present value for one machine and low demand is \$90,000. If demand is high, there are three options. One option is to do nothing, which would have a net present value of \$90,000.

A second option is to subcontract; that would have a net present value of \$110,000. The third option is to purchase a second machine. This option would have a net present value of \$100,000.

How many machines should the manager purchase initially? Use a decision tree to analyze this problem.

11. Determine the course of action that has the highest EMV for the accompanying tree diagram.

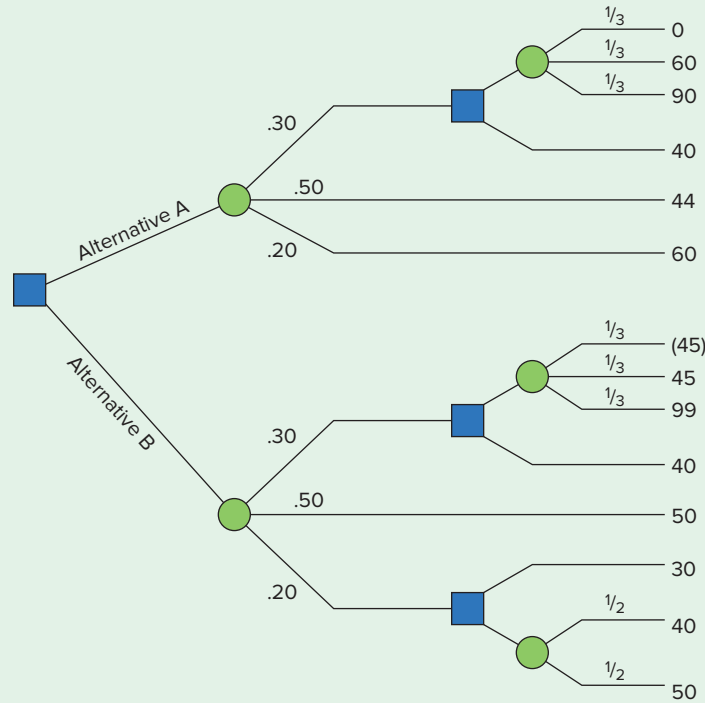

12. A logistics provider plans to have a new warehouse built to handle increasing demands for its services. Although the company is unsure of how much demand there will be, it must decide now on the size (large or small) of the warehouse. Preliminary estimates are that if a small warehouse is built and demand is low, the monthly income will be \$700,000. If demand is high, it will have to either expand the facility or lease additional space. Leasing will result in a monthly income of \$100,000, while expanding will result in a monthly income of \$500,000.

If a large warehouse is built and demand is low, monthly income will only be \$40,000, while if demand is high, monthly income will be \$2 million.

- Construct a tree diagram for this decision.
 - Using your tree diagram, identify the choice that would be made using each of the four approaches for decision making under uncertainty.
13. The director of social services of a county has learned that the state has mandated additional information requirements. This will place an additional burden on the agency. The director has identified three acceptable alternatives to handle the increased workload. One alternative is to reassign present staff members, the second is to hire and train two new workers, and the third is to redesign current practice so that workers can readily collect the information with little additional effort. An unknown factor is the caseload for the coming year when the new data will be collected on a trial basis. The estimated costs for various options and caseloads are shown in the following table.

	CASELOAD		
	Moderate	High	Very High
Reassign staff	\$50*	60	85
New staff	60	60	60
Redesign collection	40	50	90

*Cost in \$ thousands.

Assuming that past experience has shown the probabilities of various caseloads to be unreliable, what decision would be appropriate using each of the following criteria?

- a. Maximin
 - b. Maximax
 - c. Minimax regret
 - d. Laplace
14. After contemplating the caseload question (see the previous problem), the director of social services has decided that reasonable caseload probabilities are .10 for moderate, .30 for high, and .60 for very high.
- a. Which alternative will yield the minimum expected cost?
 - b. Construct a decision tree for this problem. Indicate the expected costs for the three decision branches.
 - c. Determine the expected value of perfect information using an opportunity loss table.
15. Given this payoff table:

		STATE OF NATURE	
		#1	#2
Alternative	A	\$120*	20
	B	60	40
	C	10	110
	D	90	90

*Payoff in \$ thousands.

- a. Determine the range of $P(1)$ for which each alternative would be best, treating the payoffs as profits.
 - b. Answer part *a* treating the payoffs as costs.
16. A manager has compiled estimated profits for various capacity alternatives but is reluctant to assign probabilities to the states of nature. The payoff table is as follows:

		STATE OF NATURE	
		#1	#2
Alternative	A	\$ 20*	140
	B	120	80
	C	100	40

*Profit in \$ thousands.

- a. Plot the expected-value lines on a graph.
 - b. Is there any alternative that would never be appropriate in terms of maximizing expected profit? Explain on the basis of your graph.
 - c. For what range of $P(2)$ would alternative A be the best choice if the goal is to maximize expected profit?
 - d. For what range of $P(1)$ would alternative A be the best choice if the goal is to maximize expected profit?
17. Repeat all parts of Problem 16, assuming the values in the payoff table are estimated *costs* and the goal is to minimize expected costs.
18. The research staff of a marketing agency has assembled the following payoff table of estimated profits.

		Receive Contract	Not Receive Contract
	#1	\$10*	-2
Proposal	#2	8	3
	#3	5	5
	#4	0	7

*Cost in \$ thousands.

Relative to the probability of not receiving the contract, determine the range of probability for which each of the proposals would maximize expected profit.

Anderson, David R., Dennis J. Sweeney, Thomas A. Williams, Jeffrey D. Camm, and R. Kipp Martin. *An Introduction to Management Science*, 13th ed. Mason, OH: South-Western, 2010.

Stevenson, William J., and Ceyhun Ozgur. *Introduction to Management Science with*

Spreadsheets. New York: McGraw-Hill Irwin, 2007.

Taylor, Bernard W. *Introduction to Management Science*, 11th ed. Dubuque, IA: William C. Brown, 2013.

**SELECTED
BIBLIOGRAPHY AND
FURTHER READINGS**

6

CHAPTER

Process Selection and Facility Layout

LEARNING OBJECTIVES

After completing this chapter, you should be able to:

- LO6.1** Explain the strategic importance of process selection and the influence it has on the organization and its supply chain.
- LO6.2** Name the two main factors that influence process selection.
- LO6.3** Compare the four basic processing types.
- LO6.4** Explain the need for management of technology.
- LO6.5** List some reasons for redesign of layouts.
- LO6.6** Describe product layouts and their main advantages and disadvantages.
- LO6.7** Describe process layouts and their main advantages and disadvantages.
- LO6.8** Solve simple line-balancing problems.
- LO6.9** Develop simple process layouts.

CHAPTER OUTLINE

- | | | |
|--|---|--|
| 6.1 Introduction 246 | 6.4 Process Strategy 260 | Some Guidelines for Line Balancing 276 |
| 6.2 Process Selection 246 | 6.5 Strategic Resource Organization: Facilities Layout 260 | Other Factors 279 |
| Process Types 247 | Repetitive and Continuous Processing: Product Layouts 261 | Other Approaches 279 |
| Operations Tour: Morton Salt 250 | Intermittent Processing: Process Layouts 263 | 6.7 Designing Process Layouts 281 |
| Product and Service Profiling 251 | Fixed-Position Layouts 264 | Measures of Effectiveness 281 |
| Sustainable Production of Goods and Services 252 | Combination Layouts 265 | Information Requirements 282 |
| Lean Process Design 252 | Cellular Layouts 266 | Minimizing Transportation Costs or Distances 282 |
| 6.3 Technology 252 | Service Layouts 268 | Closeness Ratings 284 |
| Automation 253 | 6.6 Designing Product Layouts: Line Balancing 272 | |
| 3D Printing 257 | | |
| Drones 259 | | |



Jeff Gilbert/Alamy Stock Photo

Product and service choices, capacity planning, process selection, and layout of facilities are among the most basic decisions managers make because they have long-term consequences for business organizations, and they impact a wide range of activities and capabilities.

This chapter is about process selection and facility layout (i.e., the arrangement of the workplace). Processes convert inputs into outputs; they are at the core of operations management. But the impact of process selection goes beyond operations management: It affects the entire organization and its ability to achieve its mission, and it affects the organization's supply chain. So, process selection choices very often have strategic significance. Different process types have different capacity ranges, and once a process type is functioning, changing it can be difficult, time consuming, and costly. Obviously, long-term forecasts, as well as an organization's mission and goals, are important in developing a process strategy.

Process selection has operational and supply chain implications. Operational implications include equipment and labor requirements, operations costs, and both the ability to meet demand and the ability to respond to variations in demand. Supply chain implications relate to the volume and variety of inputs and outputs and the degree of flexibility that is required.

Technology is often a factor in process selection and layout. Three aspects of technology can be factors: product technology, processing technology, and information technology.

Process selection and facility layout are closely tied, and for that reason, these two topics are presented in a single chapter. The first part of the chapter covers the basic options for processing work. This is followed by a discussion of how processes and layout are linked. The remainder of the chapter is devoted to layout design.

FIGURE 6.1

Process selection and capacity planning influence system design

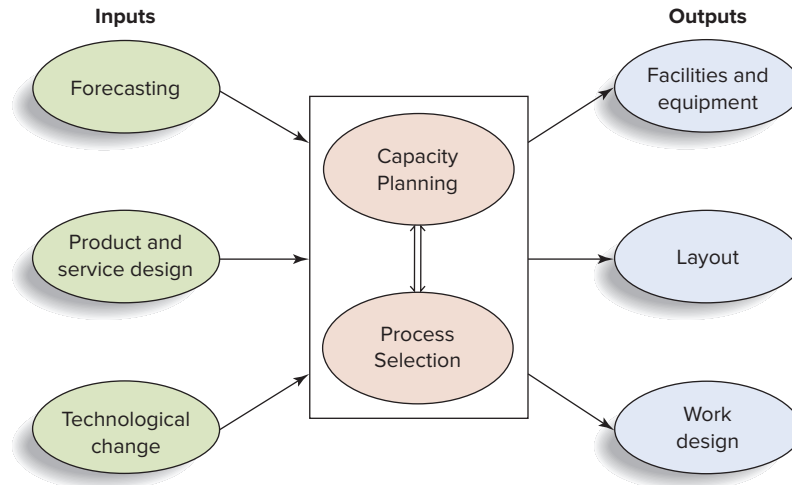

LO6.1 Explain the strategic importance of process selection and the influence it has on the organization and its supply chain.

6.1 INTRODUCTION

Process selection refers to deciding on the way production of goods or services will be organized. It has major implications for capacity planning, layout of facilities, equipment, and design of work systems. Process selection occurs as a matter of course when new products or services are being planned. However, it also occurs periodically due to technological changes in products or equipment, as well as competitive pressures. Figure 6.1 provides an overview of where process selection and capacity planning fit into system design. Forecasts, product and service design, and technological considerations all influence capacity planning and process selection. Moreover, capacity and process selection are interrelated, and are often done in concert. They, in turn, affect facility and equipment choices, layout, and work design.

How an organization approaches process selection is determined by the organization's *process strategy*. Key aspects include:

- Capital intensity: The mix of equipment and labor that will be used by the organization.
- Process flexibility: The degree to which the system can be adjusted to changes in processing requirements due to such factors as changes in product or service design, changes in volume processed, and changes in technology.

6.2 PROCESS SELECTION

LO6.2 Name the two main factors that influence process selection.

Process choice is demand-driven. The two key questions in process selection are:

1. How much variety will the process need to be able to handle?
2. How much volume will the process need to be able to handle?

Answers to these questions will serve as a guide to selecting an appropriate process. Usually, volume and variety are *inversely* related; a higher level of one means a lower level of the other. However, the need for flexibility of personnel and equipment is *directly* related to the level of variety the process will need to handle: The lower the variety, the less the need for flexibility, while the higher the variety, the greater the need for flexibility. For example, if a worker's job in a bakery is to make cakes, both the equipment and the worker will do the same thing day after day, with little need for flexibility. But if the worker has to make cakes, pies, cookies, brownies, and croissants, both the worker and the equipment must have the flexibility to be able to handle the different requirements of each type of product.

There is another aspect of variety that is important. Variety means either having dedicated operations for each different product or service, or if not, having to get equipment ready every time there is the need to change the product being produced or the service being provided.

Process Types

There are five basic process types: job shop, batch, repetitive, continuous, and project.

Job Shop. A job shop usually operates on a relatively small scale. It is used when a low volume of high-variety goods or services will be needed. Processing is *intermittent*; work includes small jobs, each with somewhat different processing requirements. High flexibility using general-purpose equipment and skilled workers are important characteristics of a job shop. A manufacturing example of a job shop is a tool and die shop that is able to produce one-of-a-kind tools. A service example is a veterinarian's office, which is able to process many types of animals and a variety of injuries and diseases.

Batch. Batch processing is used when a moderate volume of goods or services is desired, and it can handle a moderate variety in products or services. The equipment need not be as flexible as in a job shop, but processing is still intermittent. The skill level of workers doesn't need to be as high as in a job shop because there is less variety in the jobs being processed. Examples of batch systems include bakeries, which make bread, cakes, or cookies in batches; movie theaters, which show movies to groups (batches) of people; and airlines, which carry planeloads (batches) of people from airport to airport. Other examples of products that lend themselves to batch production are paint, ice cream, soft drinks, beer, magazines, and books. Other examples of services include plays, concerts, music videos, radio and television programs, and public address announcements.



Ingram Publishing

A job shop process: A Midwestern hospital medical team performs a diagnostic procedure involving a cardiac catheterization.



Don Tremain/Getty Images

A batch process: Menu items are prepared in batches, in the kitchen of the Spago Restaurant in the Forum at Caesar's Palace, Las Vegas, Nevada.



Glow Images

A repetitive process: Vans on an assembly line with parts added in a sequential order.



vichie81/123RF

A continuous process: An oil refinery performs a continuous process, mixing and separating crude oil into gas, fuel oil, chemicals, and many other products.

Repetitive. When higher volumes of more standardized goods or services are needed, repetitive processing is used. The standardized output means only slight flexibility of equipment is needed. Skill of workers is generally low. Examples of this type of system include production lines and assembly lines. Sometimes these terms are used interchangeably, although assembly lines generally involve the last stages of an assembled product. Familiar products made by these systems include automobiles, television sets, smartphones, and computers. An example of a service system is an automatic carwash. Other examples of service include cafeteria lines and ticket collectors at sports events and concerts. Also, *mass customization* is an option.

Continuous. When a very high volume of nondiscrete, highly standardized output is desired, a continuous system is used. These systems have almost no variety in output and, hence, no need for equipment flexibility. Workers' skill requirements can range from low to high, depending on the complexity of the system and the expertise that workers need. Generally, if equipment is highly specialized, worker skills can be lower. Examples of nondiscrete products made in continuous systems include petroleum products, steel, sugar, flour, and salt. Continuous services include air monitoring, supplying electricity to homes and businesses, and the internet.

These process types are found in a wide range of manufacturing and service settings. The ideal is to have process capabilities match product or service requirements. Failure to do so can result in inefficiencies and higher costs than are necessary, perhaps creating a competitive disadvantage. Table 6.1 provides a brief description of each process type, along with the advantages and disadvantages of each.

Figure 6.2 provides an overview of these four process types in the form of a matrix, with an example for each process type. Note that job variety, process flexibility, and unit cost are highest for a job shop and get progressively lower moving from job shop to continuous processing. Conversely, volume of output is lowest for a job shop and gets progressively higher moving from job shop to continuous processing. Note, too, that the examples fall along the diagonal. The implication is that the diagonal represents the ideal choice of processing system for a given set of circumstances. For example, if the goal is to be able to process a small volume of jobs that will involve high variety, job shop processing is most appropriate. For less variety and a higher volume, a batch system would be most appropriate, and so on. Note that combinations far from the diagonal would not even be considered, such as using a job shop for high-volume, low-variety jobs, or continuous processing for low-volume, high-variety jobs, because that would result in either higher than necessary costs or lost opportunities.

Another consideration is that products and services often go through *life cycles* that begin with low volume, which increases as products or services become better known. When that happens, a manager must know when to shift from one type of process (e.g., job shop) to the next (e.g., batch). Of course, some operations remain at a certain level (e.g., magazine publishing), while others increase (or decrease as markets become saturated) over time. Again, it is important for a manager to assess his or her products and services and make a judgment on whether to plan for changes in processing over time.

All of these process types (job shop, batch, repetitive, and continuous) are typically ongoing operations. However, some situations are not ongoing but instead are of limited duration. In such instances, the work is often organized as a *project*.

LO6.3 Compare the four basic processing types.

TABLE 6.1
Types of processing

	Job Shop	Batch	Repetitive/ Assembly	Continuous
Description	Customized goods or services	Semi-standardized goods or services	Standardized goods or services	Highly standardized goods or services
Advantages	Able to handle a wide variety of work	Flexibility; easy to add or change products or services	Low unit cost, high volume, efficient	Very efficient, very high volume
Disadvantages	Slow, high cost per unit, complex planning and scheduling	Moderate cost per unit, moderate scheduling complexity	Low flexibility, high cost of downtime	Very rigid, lack of variety, costly to change, very high cost of downtime

Product or Service Variety and Equipment Flexibility

	High Variety	Moderate Variety	Low Variety	Very Low Variety
Low or very low volume	Job Shop repair shop emergency room			
Moderate volume		Batch commercial bakery classroom lecture		
High volume			Repetitive assembly line automatic car wash	
Very high volume				Continuous Flow petroleum refining water treatment

FIGURE 6.2
Volume and variety influence process choice

Project. A **project** is used for work that is nonroutine, with a unique set of objectives to be accomplished in a limited time frame. Examples range from simple to complicated, including such things as putting on a play, consulting, making a motion picture, launching a new product or service, publishing a book, building a dam, and building a bridge. Equipment flexibility and worker skills can range from low to high.

Project A nonrepetitive set of activities directed toward a unique goal within a limited time frame.

The type of process or processes used by an organization influences a great many activities of the organization. Table 6.2 briefly describes some of those influences.

Process type also impacts supply chain requirements. Repetitive and continuous processes require steady inputs of high-volume goods and services. Delivery reliability in terms of quality and timing is essential. Job shop and batch processing may mean that suppliers have to be able to deal with varying order quantities and timing of orders. In some instances, seasonality is a factor, so suppliers must be able to handle periodic large demand.

The processes discussed do not always exist in their “pure” forms. It is not unusual to find hybrid processes—processes that have elements of other process types embedded in them. For instance, companies that operate primarily in a repetitive mode, or a continuous mode,

TABLE 6.2
Process choice affects numerous activities/functions

Activity/ Function	Job Shop	Batch	Repetitive	Continuous	Projects
Cost estimation	Difficult	Somewhat routine	Routine	Routine	Simple to complex
Cost per unit	High	Moderate	Low	Low	Very high
Equipment used	General purpose	General purpose	Special purpose	Special purpose	Varied
Fixed costs	Low	Moderate	High	Very high	Varied
Variable costs	High	Moderate	Low	Very low	High
Labor skills	High	Moderate	Low	Low to high	Low to high
Marketing	Promote capabilities	Promote capabilities; semi-standardized goods and services	Promote standardized goods/services	Promote standardized goods/services	Promote capabilities
Scheduling	Complex	Moderately complex	Routine	Routine	Complex, subject to change
Work-in-process inventory	High	High	Low	Low	Varied



Introduction

Morton Salt is a subsidiary of Morton International, a manufacturer of specialty chemicals, air bags, and salt products. The Morton salt-processing facility in Silver Springs, New York, between Buffalo and Rochester, is one of six similar Morton salt-processing facilities in the United States. The Silver Springs plant employs about 200 people, ranging from unskilled to skilled. It produces salt products for water conditioning, grocery, industrial, and agricultural markets. The grocery business consists of 26-oz. round cans of iodized salt. Although the grocery business represents a relatively small portion of the total output (approximately 15 percent), it is the most profitable.

Salt Production

The basic raw material, salt, is obtained by injecting water into salt caverns that are located some 2,400 feet below the surface. There, the salt deposits dissolve in the water. The resulting brine is pumped to the surface where it is converted into salt crystals. The brine is boiled, and much of the liquid evaporates, leaving salt crystals and some residual moisture, which is removed in a drying process. This process is run continuously for about six weeks at a time. Initially, salt is produced at the rate of 45 tons per hour. But the rate of output decreases due to scale buildup, so that by the sixth week, output is only 75 percent of the initial rate. At that point, the process is halted to perform maintenance on the equipment and remove the scale, after which salt production resumes.

The salt is stored in silos until it is needed for production, or it is shipped in bulk to industrial customers. Conveyors move the salt to each of the four dedicated production areas, one of which is round can production. (See diagram.) The discussion here focuses exclusively on round can production.

Round Can Production

Annual round can production averages roughly 3.8 million cans. Approximately 70 percent of the output is for the Morton label, and the rest is for a private label. There are two parallel, high-speed production lines. The two lines share common processes at the beginning of the lines, and then branch out into two identical lines. Each line is capable of producing 9,600 cans per hour (160 cans per minute). The equipment is not flexible, so the production rate is fixed. The operations are completely standardized; the only variable is the brand label that is applied. One line requires 12 production workers, while both lines together can be operated by 18 workers because of the common processes. Workers on the line perform low-skilled, repetitive tasks.

The plant produces both the salt and the cans the salt is packaged in. The cans are essentially a cylinder with a top and a bottom; they are made of cardboard, except for a plastic pour spout in the top. The cylinder portion is formed from two sheets of chip board that are glued together and then rolled into a continuous tube. The glue not only binds the material, it

also provides a moisture barrier. The tube is cut in a two-step process: It is first cut into long sections, and those sections are then cut into can-size pieces. The top and bottom pieces for the cans are punched from a continuous strip of cardboard. The separate pieces move along conveyor belts to the lines where the components are assembled into cans and glued. The cans are then filled with salt and the pour spout is added. Finally, the cans are loaded onto pallets and placed into inventory, ready to be shipped to distributors.

Quality

Quality is checked at several points in the production process. Initially, the salt is checked for purity when it is obtained from the wells. Iodine and an anti-caking compound are added to the salt, and their levels are verified using chemical analysis. Crystal size is important. In order to achieve the desired size and to remove lumps, the salt is forced through a scraping screen, which can cause very fine pieces of metal to mix with the salt. However, these pieces are effectively removed by magnets that are placed at appropriate points in the process. If, for any reason, the salt is judged to be contaminated, it is diverted to a nonfood product.

Checking the quality of the cans is done primarily by visual inspection, including verifying the assembly operation is correct, checking filled cans for correct weight, inspecting cans to see that labels are properly aligned, and checking to see that plastic pour spouts are correctly attached.

The equipment on the production line is sensitive to misshapen or damaged cans, and frequently jams, causing production delays. This greatly reduces the chance of a defective can getting through the process, but it reduces productivity, and the salt in the defective cans must be scrapped. The cost of quality is fairly high, owing to the amount of product that is scrapped, the large number of inspectors, and the extensive laboratory testing that is needed.

Production Planning and Inventory

The plant can sell all of the salt it produces. The job of the production scheduler is to distribute the salt that is stored in the silos to the various production areas, taking into account production capacities in each area and available inventory levels of those products. A key consideration is to make sure there is sufficient storage capacity in the silos to handle the incoming salt from brine production.

Equipment Maintenance and Repair

The equipment is 1950s vintage, and it requires a fair amount of maintenance to keep it in good working order. Even so, breakdowns occur as parts wear out. The plant has its own tool shop where skilled workers repair parts or make new parts because replacement parts are no longer available for the old equipment.

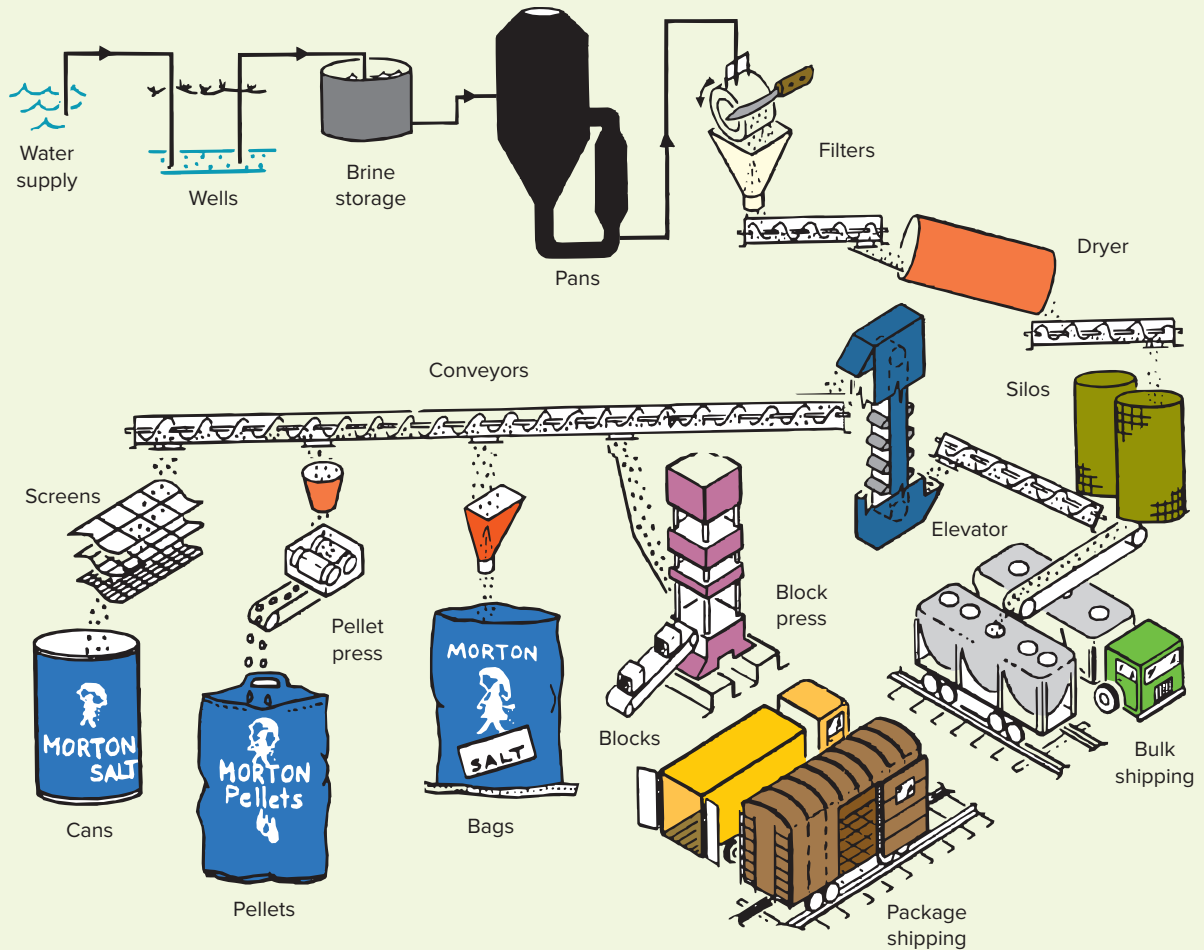

Questions

- Briefly describe salt production, from brine production to finished round cans.
- Briefly describe quality assurance efforts in round can production.
- What are some of the possible reasons why the company continues to use the old processing equipment instead of buying new, more modern equipment?
- Where would you place salt production in the product-process spectrum?
- Determine the approximate number of tons of salt produced annually for the grocery market. *Hints:* one ton = 2,000 pounds, and one pound = 16 ounces.
- What improvements can you suggest for the plant?

will often have repair shops (i.e., job shops) to fix or make new parts for equipment that fails. Also, if volume increases for some items, an operation that began, say, in a job shop or as a batch mode may evolve into a batch or repetitive operation. This may result in having some operations in a job shop or batch mode, and others in a repetitive mode.

Product and Service Profiling

Process selection can involve substantial investment in equipment and have a very specific influence on the layout of facilities, which also require heavy investment. Moreover, mismatches between operations capabilities and market demand and pricing or cost strategies can have a significant negative impact on the ability of the organization to compete or, in government agencies, to effectively service clients. Therefore, it is highly desirable to assess the

Product or service profiling

Linking key product or service requirements to process capabilities.

degree of correlation between various process choices and market conditions *before* making process choices in order to achieve an appropriate matching.

Product or service profiling can be used to avoid any inconsistencies by identifying key product or service dimensions and then selecting appropriate processes. Key dimensions often relate to the range of products or services that will be processed, expected order sizes, pricing strategies, expected frequency of schedule changes, and order-winning requirements.

Sustainable Production of Goods and Services

Business organizations are facing increasing pressure from a variety of sources to operate sustainable production processes. According to the Lowell Center for Sustainable Production (<http://sustainableproduction.org>), “Sustainable Production is the creation of goods and services using processes and systems that are: non-polluting; conserving of energy and natural resources; economically efficient; safe and healthful for workers, communities, and consumers; and socially and creatively rewarding for all working people.” To achieve this, the Lowell Center advocates designing and operating processes in ways that:

- “wastes and ecologically incompatible byproducts are reduced, eliminated or recycled on-site;
- chemical substances or physical agents and conditions that present hazards to human health or the environment are eliminated;
- energy and materials are conserved, and the forms of energy and materials used are most appropriate for the desired ends; and
- work spaces are designed to minimize or eliminate chemical, ergonomic and physical hazard.”

To achieve these goals, business organizations must focus on a number of factors that include energy use and efficiency, CO₂ (carbon footprint) and toxic emissions, waste generation, lighting, heating, cooling, ventilation, noise and vibration, and worker health and safety.

Lean Process Design

Lean process design is guided by general principles that are discussed more fully in a later chapter. One principle of particular interest here is waste reduction, which relates to sustainability objectives. Lean design also focuses on variance reduction in workload over the entire process to achieve level production and thereby improve process flow. Successful lean design results in reduced inventory and floor space; quicker response times and shorter lead times; reduced defects, rework, and scrap; and increased productivity. Lean design is often translated into practice using cellular layouts, which are discussed later in this chapter.

Lean process design has broad applications in seemingly diverse areas such as health care delivery systems, manufacturing, construction projects, and process reengineering.

LOG.4 Explain the need for management of technology.

6.3 TECHNOLOGY

Technological innovation

The discovery and development of new or improved products, services, or processes for producing or providing them.

Technology The application of scientific discoveries to the development and improvement of products and services and operations processes.

Technology and technological innovation often have a major influence on business processes.

Technological innovation refers to the discovery and development of new or improved products, services, or processes for producing or providing them. **Technology** refers to applications of scientific knowledge to the development and improvement of goods and services and/or the processes that produce or provide them. The term *high technology* refers to the most advanced and developed equipment and/or methods.

Process technology and information technology can have a major impact on costs, productivity, and competitiveness. *Process technology* includes methods, procedures, and equipment used to produce goods and provide services. This not only involves processes within an organization, it also extends to supply chain processes. *Information technology (IT)* is the science and use of computers and other electronic equipment to store, process, and send information. IT is

heavily ingrained in today's business operations. This includes electronic data processing, the use of bar codes and radio frequency tags to identify and track goods, devices used to obtain point-of-sale information, data transmission, the internet, e-commerce, e-mail, and more.

With radio frequency (RFID) tags, items can be tracked during production and in inventory. For outbound goods, readers at a packing station can verify that the proper items and quantities were picked before shipping the goods to a customer or a distribution center. In a hospital setting, RFID tags can be used in several ways. One is to facilitate keeping accurate track of hospital garments, automating the process by which clean garments are inventoried and disbursed. An RFID tag can be worn by each hospital employee. The tag contains a unique ID number which is associated with each wearer. When an employee comes to the counter to pick up garments, the employee's tag is scanned and software generates data regarding garment, type, size, location on racks, and availability for that employee. The garments are then picked from the specified racks, their RFID tag is read by a nearby scanner and processed, and the database is automatically updated.

Technological innovation in processing technology can produce tremendous benefits for organizations by increasing quality, lowering costs, increasing productivity, and expanding processing capabilities. Among the examples are laser technology used in surgery and laser measuring devices, advances in medical diagnostic equipment, high-speed internet connections, high-definition television, online banking, information retrieval systems, and high-speed search engines. Processing technologies often come through acquisition rather than through internal efforts of an organization.

While process technology can have enormous benefits, it also carries substantial risk unless a significant effort is made to fully understand both the downside and the upside of a particular technology. It is essential to understand what the technology will and won't do. Also, there are economic considerations (initial cost, space, cash flow, maintenance, consultants), integration considerations (cost, time, resources), and human considerations (training, safety, job loss).

Automation

An increasingly asked question in process design is whether to automate. **Automation** is machinery that has sensing and control devices that enable it to operate automatically. If a company decides to automate, the next question is how much. Automation can range from factories that are completely automated to a single automated operation.

Automated services are becoming increasingly important. Examples range from automated teller machines (ATMs) to automated heating and air conditioning and include automated inspection, automated storage and retrieval systems, package sorting, mail processing, e-mail, online banking, and E-Z pass.

Automation offers a number of advantages over human labor. It has low variability, whereas it is difficult for a human to perform a task in exactly the same way, in the same amount of time, and on a repetitive basis. In a production setting, variability is detrimental to quality and to meeting schedules. Moreover, machines do not get bored or distracted, nor do they go on strike, ask for higher wages, or file labor grievances. Still another advantage of automation is the reduction of variable costs. In order for automated processing to be an option, job-processing requirements must be *standardized* (i.e., have very little or no variety).

Both manufacturing and service organizations are increasing their use of automation as a way to reduce costs, increase productivity, and improve quality and consistency.

Automation is frequently touted as a strategy necessary for competitiveness. However, automation also has certain disadvantages and limitations compared to human labor. To begin with, it can be costly. Technology is expensive; usually it requires high volumes of output to offset high costs. In addition, automation is much less flexible than human labor. Once a process has been automated, there are substantial reasons for not changing it. Moreover, workers sometimes fear automation because it might cause them to lose their jobs. This can have an adverse effect on morale and productivity.

Decision makers must carefully examine the issue of whether to automate, or the degree to which to automate, so they clearly understand all the ramifications. Also, much thought and

Automation Machinery that has sensing and control devices that enable it to operate automatically.



Foxconn operates a network of factories across the Chinese mainland, employing 1.2 million people, that makes products for tech companies that include Apple, Hewlett Packard, and Dell. The electronics manufacturing giant has been on a steady course for a while to replace manpower with robotic systems.

“Foxconn (has) vowed to install up to 1 million robots in its factories over the next three years, which analysts suggested was in part to address long-time scandals such as high suicide rates among employees and exploitation of workers.”

Foreign manufacturers in China are also viewing upgrades as vital to their operations in the country. In fact, numerous multinational companies have recognized the long-term benefits of replacing human labor with robots.

Questions

1. As Foxconn cuts jobs as it shifts to greater use of automation, jobs will be created in other companies. In what types of companies would you expect to see jobs created?
2. Many companies outsourced their manufacturing activities to Foxconn due to its low labor costs. Does Foxconn’s shift to automation make it likely that some of those companies will reconsider outsourcing in favor of shifting to automation? What are some reasons for staying with Foxconn, and what are some reasons that favor shifting to their own automated processes?

Source: Based on “Foxconn halts recruitment as focus shifts to automation,” He Wei in Shanghai, *China Daily*, February 2, 2013, p. 9.

careful planning are necessary to successfully *integrate* automation into a production system. Otherwise, it can lead to major problems. Automation has important implications not only for cost and flexibility, but also for the fit with overall strategic priorities. If the decision is made to automate, care must be taken to remove waste from the system prior to automating, to avoid building the waste into the automated system. Table 6.3 has a list of questions for organizations that are considering automation.

Generally speaking, there are three kinds of automation: fixed, programmable, and flexible.

Fixed automation is the least flexible. It uses high-cost, specialized equipment for a fixed sequence of operations. Low cost and high volume are its primary advantages; minimal variety and the high cost of making major changes in either product or process are its primary limitations.

Programmable automation involves the use of high-cost, general-purpose equipment controlled by a computer program that provides both the sequence of operations and specific details about each operation. This type of automation has the capability of economically producing a fairly wide variety of low-volume products in small batches. Numerically controlled (N/C) machines and some robots are applications of programmable automation.

Computer-aided manufacturing (CAM) refers to the use of computers in process control, ranging from robots to automated quality control. **Numerically controlled (N/C) machines** are programmed to follow a set of processing instructions based on mathematical relationships that tell the machine the details of the operations to be performed. The instructions are stored on a device such as a microprocessor. Although N/C machines have been used for many years, they are an important part of new approaches to manufacturing. Individual machines often have their own computer; this is referred to as *computerized numerical control (CNC)*. Or one computer may control a number of N/C machines, which is referred to as *direct numerical control (DNC)*.

N/C machines are best used in cases where parts are processed frequently and in small batches, where part geometry is complex, close tolerances are required, mistakes are costly, and there is the possibility of frequent changes in design. The main limitations of N/C

Computer-aided manufacturing (CAM) The use of computers in process control.

Numerically controlled (N/C) machines Machines that perform operations by following mathematical processing instructions.

TABLE 6.3

Automation questions

1. What level of automation is appropriate? (Some operations are more suited to being automated than others, so partial automation can be an option.)
2. How would automation affect the flexibility of an operation system?
3. How can automation projects be justified?
4. How should changes be managed?
5. What are the risks of automating?
6. What are some of the likely effects of implementing automation on market share, costs, quality, customer satisfaction, labor relations, and ongoing operations?



Andrii77/Shutterstock

Computer numerical control (CNC) refers to a computer that reads instructions and drives a machine tool. CNC machines are controlled directly from files created by CAM software packages. With increased automation of manufacturing processes with CNC machining, considerable improvements in consistency and quality have been achieved. CNC automation reduces the frequency of errors and provides operators with time to perform additional tasks. The intelligence of CNC controllers has dramatically increased job shop cell production. Some machines might even make 1,000 parts on a weekend with no operator, checking each part with lasers and sensors.

machines are the higher skill levels needed to program the machines and their inability to detect tool wear and material variation.

The use of robots in manufacturing is sometimes an option. Robots can handle a wide variety of tasks, including welding, assembly, loading and unloading of machines, painting, and testing. They relieve humans from heavy or dirty work and often eliminate drudgery tasks.

Some uses of robots are fairly simple, others are much more complex. At the lowest level are robots that follow a fixed set of instructions. Next are programmable robots, which can repeat a set of movements after being led through the sequence. These robots “play back” a mechanical sequence much as a video recorder plays back a visual sequence. At the next level up are robots that follow instructions from a computer. Below are robots that can recognize objects and make certain simple decisions.

Still another form of robots are collaborative robots (also known as cobots) that are designed to work collaboratively with humans. The collaborative application of robotics enables humans and robots to work together safely and effectively, augmenting the capabilities of their human counterparts, achieving results neither could do alone. Cobots are designed with multiple advanced sensors, software, and end of arm tooling that help them quickly and easily sense and adapt to anything that comes into their work space. They also have the ability to detect any abnormal force applied to their joints while in motion. These robots can be programmed to respond immediately by stopping or reversing positions when they come into contact with a human.

Flexible automation evolved from programmable automation. It uses equipment that is more customized than that of programmable automation. A key difference between the two is that flexible automation requires significantly less changeover time. This permits almost continuous operation of equipment *and* product variety without the need to produce in batches.

In practice, flexible automation is used in several different formats.

A **flexible manufacturing system (FMS)** is a group of machines that include supervisory computer control, automatic material handling, and robots or other automated processing equipment. Reprogrammable controllers enable these systems to produce a variety of *similar* products. Systems may range from three or four machines to more than a dozen. They are designed to handle intermittent processing requirements with some of the benefits of automation and some of the flexibility of individual, or stand-alone, machines (e.g., N/C machines). Flexible manufacturing systems offer reduced labor costs and more consistent quality when compared with more traditional manufacturing methods, lower capital investment and higher

Flexible manufacturing system (FMS) A group of machines designed to handle intermittent processing requirements and produce a variety of similar products.

Tmsuk's receptionist robot is used for medical purposes. These robots can guide a hospital visitor to a nearby elevator. If a human touches the panel on the robot's body or speaks to it, the robot can display or print directions.



STR/AFP/Getty Images

flexibility than “hard” automation, and relatively quick changeover time. Flexible manufacturing systems often appeal to managers who hope to achieve both the flexibility of job shop processing and the productivity of repetitive processing systems.

Although these are important benefits, an FMS also has certain limitations. One is that this type of system can handle a relatively narrow range of part variety, so it must be used for a family of similar parts, which all require similar machining. Also, an FMS requires longer planning and development times than more conventional processing equipment because of its increased complexity and cost. Furthermore, companies sometimes prefer a gradual approach to automation, and FMS represents a sizable chunk of technology.

Computer-integrated manufacturing (CIM) A system for linking a broad range of manufacturing activities through an integrating computer system.

Computer-integrated manufacturing (CIM) is a system that uses an integrating computer system to link a broad range of manufacturing activities, including engineering design, flexible manufacturing systems, purchasing, order processing, and production planning and control. Not all elements are absolutely necessary. For instance, CIM might be as simple as linking two or more FMSs by a host computer. More encompassing systems can link scheduling, purchasing, inventory control, shop control, and distribution. In effect, a CIM system integrates information from other areas of an organization with manufacturing.

The overall goal of using CIM is to link various parts of an organization to achieve rapid response to customer orders and/or product changes, to allow rapid production, and to reduce *indirect* labor costs.

A shining example of how process choices can lead to competitive advantages can be found at Allen-Bradley's computer-integrated manufacturing process in Milwaukee, Wisconsin. The company converted a portion of its factory to a fully automated “factory within a factory” to assemble contacts and relays for electrical motors. A handful of humans operate the factory, although once an order has been entered into the system, the machines do virtually all the work, including packaging and shipping, and quality control. Any defective items are removed from the line, and replacement parts are automatically ordered and scheduled to compensate for the defective items. The humans program the machines, monitor operations, and attend to any problems signaled by a system of warning lights.



Bill Pugliano/Getty Images

At the Ford Motor plant in Michigan, in the final assembly area, flexibility means that the build sequence is the same, regardless of model, on one or more platforms. This allows for efficient use of people and equipment.

As orders come into the plant, computers determine production requirements and schedules and order the necessary parts. Bar-coded labels that contain processing instructions are automatically placed on individual parts. As the parts approach a machine, a sensing device reads the bar code and communicates the processing instructions to the machine. The factory can produce 600 units an hour.

The company has realized substantial competitive advantages from the system. Orders can be completed and shipped within 24 hours of entry into the system, indirect labor costs and inventory costs have been greatly reduced, and quality is very high.

The Internet of Things (IoT). The internet of things is the extension of internet connectivity into devices such as cell phones, vehicles, audio and video device, and much more, some of which you are probably familiar with. These devices can send and receive information with others over the internet. Industrial use of the IoT will have a major impact on manufacturing and the global economy with intelligence that augments human capabilities. Applications involve AI (artificial intelligence) machine learning, quality and productivity improvement, and predictive maintenance.

3D Printing

A 3D printer is a type of *industrial robot* that is controlled using computer-assisted design (CAD). **3D printing**, also known as *additive manufacturing*, involves processes that create three-dimensional objects by applying successive layers of materials to create the objects. The objects can be of almost any size or shape. These processes are different than many familiar processes that use *subtractive manufacturing* to create objects: Material is removed by methods such as cutting, grinding, sanding, drilling, and milling. Also, producing an object using 3D printing is generally much slower than the time needed using more conventional techniques in a factory setting.

In early applications, material was deposited onto a powder bed using inkjet printer heads—hence, the name *3D printing*. Today, the term 3D printing refers to a wide range of techniques such as *extrusion* (the deformation of either metal or plastic forced under pressure through a die to create a shape) and *sintering* (using heat or pressure or both to form a solid material from powder without causing it to liquefy).

3D printing A process that creates a three-dimensional object by adding successive layers of material.



BY LISA SPENCER

Clinics in Rwanda used to struggle to stock the correct amount of blood products for medical procedures and emergency care. Because the need for blood often arises with little warning via accidents or emergencies and because blood is not a one-size-fits-all product, trying to forecast how much of what kind to keep on hand was problematic. Refrigerated blood only lasts about 42 days, so controlling inventory so it doesn't expire and go to waste is critical. Even transporting the blood posed great challenges for rural clinics in a mountainous country with inferior roads and infrastructure. If the right type of blood was not on hand, and with many clinics up to a three-hour drive from the country's blood banks, doctors sometimes had to fly patients to national hospitals rather than wait for blood deliveries to arrive.

Zipline partnered with UPS to change that. In October of 2016, Zipline's Rwanda project became the world's first national drone delivery system. Today, Zipline utilizes the fastest commercial delivery drone in the world. Doctors text or call in orders for blood products as needed, and rural clinics are now only a 15- to 45-minute drone flight from the distribution centers. Approximately a third of the blood deliveries are for emergency life-saving situations. This on-demand system has reduced waste and spoilage by 95 percent.

Zipline drones are fixed-wing style airplanes rather than the more typical quadcopter. The plane-like design of the drone gives it a much greater range than a quadcopter, and it is also more resilient in bad weather. However, unlike a quadcopter, it cannot take off,

land, and take off again. Rather, once the drone is launched, it flies to its destination and the box containing the blood delivery parachutes down to the clinic. The drone then circles back to its home base. The drone can travel 93 miles on a single charge. Already in its second generation of drones, Zipline's newest system cut the time between receipt of an order and launch of the drone from ten minutes to one. Also, the daily number of possible flights increased from 50 to 500.

The Rwandan government, as part of its strategy of adopting new cutting-edge technologies, welcomed the program. Less cumbersome aviation regulations and a much quieter air space compared to developed countries like the United States enabled this small African nation to leap to the forefront of drone technology. Zipline is also working in Tanzania to develop similar delivery systems for a variety of medical supplies, and the company plans to expand its services in the United States as well.

Questions

1. What other sorts of companies or products could benefit from this on-demand delivery technology?
2. What issues or concerns make implementing this technology more difficult in developed countries like the United States than in developing countries in East Africa?

Source: Based on "Zipline Unveiled the Fastest Commercial Delivery Drone on Earth." *Design Products and Applications*, June 18, 2018. <http://www.dpaonthenet.net/article/155369/Zipline-launches-fastest-delivery-drone-in-the-world.aspx>

3D printers come in a wide variety of sizes and shapes. Some printers look very much like a microwave oven, while others look completely different.

The use of *3D scanning* technologies allows the replication of objects without the use of molds. That can be beneficial in cases where molding techniques are difficult or costly, or where contact with substances used in molding processes could harm the original item. 3D objects can also be created from photographs of an existing object. That involves taking a series of photographs of the object (usually about 20) from various angles in order to capture adequate detail of the object for reproduction.

It is possible that in the long term, 3D printing technologies could have a significant impact on where and how production occurs and on supply chains.

Applications. Commercial applications of 3D printing are occurring in a wide array of businesses, and also have a few consumer applications, some of which are shown in Table 6.4.

Benefits. Although 3D printing is unlikely to replace more widespread forms of high-volume production in the foreseeable future, it does offer an alternate form of production that provides value in a wide range of applications, even in high-volume systems. In some of those applications, manufacturers have been able to substantially reduce the cost and/or time needed to develop or produce items. Among the examples is production of replacement parts in the case of equipment failure when no spare parts are available. Replacement occurs much faster than the time it would take to receive the part from a supplier, thereby avoiding costly production delays. Other examples include economical production of small quantities of items, and the avoidance of shipping costs and time when the application is not near a supplier.

Advances in 3D printing and reduced costs have fueled a growth in on-demand and micro-manufacturing. On-demand production is not only attractive to customers who want



Self-driving vehicles, sometimes referred to as *autonomous vehicles*, are expected to populate the roadways in the not too distant future. They will be equipped with multiple cameras and sensors, GPS and other guidance systems, giving them the ability to operate vehicles with little or no human assistance. They will be able to communicate with similarly equipped nearby vehicles, which will add to their ability to operate safely with other vehicles. Among the expected benefits are reducing traffic congestion due to their ability to operate closely to other vehicles safely, reducing the number of accidents and injuries, and providing transportation for those unable to drive. There is a very likely possibility that self-driving trucks or other vehicles will be used to make deliveries without the need for drivers.

However, issues remain before the vehicles are ready for prime time, including figuring out: how to keep sensors clean of dirt and

snow so they can function as intended; how vehicles will be able to maneuver on roads when snow or dirt cover lane markers; how to enable vehicles to operate properly during snowy, rainy, or foggy conditions; and how to compensate when these vehicles coexist with human-operated ones.

Questions

1. Drones have been mentioned as possible ways to deliver packages to customers. What advantages might self-driving delivery vehicles have compared to drones for package delivery?
2. What conflicts do you envision when self-driving vehicles coexist with human-operated vehicles?

Industrial Applications

Mass customization: Customers can create unique designs for standard goods (e.g., cell phone cases)

Distributed manufacturing: Local 3D printing centers that can produce goods on demand for pickup

Computers: Computers, motherboards, other parts

Robots: Robots and robot parts

Rapid prototyping: Rapid fabrication of a scale model of a physical part or assembly

Rapid manufacturing: Inexpensive production of one or a small number of items

Medical devices: Prosthetics

Dental: Crowns, implants

Pharmaceutical: Pills and medicines

Food products: Candy, chocolate, crackers, and pasta

Apparel: Custom-designed footwear, eyeglass frames

Space exploration: Tools and parts can be made on the international space station as needed instead of incurring the cost and time needed to transport them from earth

Vehicles: Automotive parts, and replacement parts at repair shops; airplane parts and spare parts; also, combine multiple parts into a single part

Construction: Architectural scale models

Consumer Applications

Hobbyists: Models, parts, and replacement parts (e.g., for drones)

Appliances and tools: Replacement parts

TABLE 6.4

Some examples of applications of 3D technology

customization, it also reduces inventory needs, and hence, storage space and costs. Additional benefits are increased agility and a reduction in the need for end-item forecasts.

3D printing will become even more useful through development in three areas: printers and printing methods, software to design and print, and materials used in printing.

Drones

Drones are unmanned aircraft, usually small, and remotely controlled or programmed to fly to a specific location. An important benefit is providing an “eye-in-the sky” to obtain visual detail in places that are hazardous to humans or that are not readily accessible. For example, drones are proving to be very helpful in assessing storm and earthquake damage, especially in situations where access by vehicles or on foot is difficult or impossible due to the terrain, debris, or where roads or bridges are impassible. They are also useful for assessing crop damage, monitoring forest fires, and inspecting pipelines, cell towers, railroad tracks, and power lines. In addition, when medicines and medical supplies are urgently needed in remote areas, drones can be used to deliver them. Despite these many benefits, the use of drones poses a number of issues. There is the possibility of collisions with other drones, power lines, birds, or other objects, as well as mechanical failure or operator error, any of which can result in failure to accomplish the intended task. In addition, crashes have the potential to injure nearby humans or cause damage to property.

6.4 PROCESS STRATEGY

Throughout this book, the importance of *flexibility* as a competitive strategy is stressed. However, flexibility does not always offer the best choice in processing decisions. Flexible systems and equipment are often more expensive and not as efficient as less flexible alternatives. In certain instances, flexibility is unnecessary because products are in mature stages, requiring few design changes, and there is a steady volume of output. Ordinarily, this type of situation calls for specialized processing equipment, with no need for flexibility. The implication is clear: Flexibility should be adopted with great care; its applications should be matched with situations in which a *need* for flexibility clearly exists.

In practice, decision makers choose flexible systems for either of two reasons: Demand variety or uncertainty exists about demand. The second reason can be overcome through improved forecasting.

6.5 STRATEGIC RESOURCE ORGANIZATION: FACILITIES LAYOUT

LO6.5 List some reasons for redesign of layouts.

Layout refers to the configuration of departments, work centers, and equipment, with particular emphasis on movement of work (customers or materials) through the system. This section describes the main types of layout designs and the models used to evaluate design alternatives.

As in other areas of system design, layout decisions are important for three basic reasons: (1) they require substantial investments of money and effort; (2) they involve long-term commitments, which makes mistakes difficult to overcome; and (3) they have a significant impact on the cost and efficiency of operations.

The need for layout planning arises both in the process of designing new facilities and in redesigning existing facilities. The most common reasons for redesign of layouts include inefficient operations (e.g., high cost, bottlenecks), accidents or safety hazards, changes in the design of products or services, introduction of new products or services, changes in the volume of output or mix of outputs, changes in methods or equipment, changes in environmental or other legal requirements, and morale problems (e.g., lack of face-to-face contact).

Poor layout design can adversely affect system performance. For example, a change in the layout at the Minneapolis–St. Paul International Airport solved a problem that had plagued travelers. In the former layout, security checkpoints were located in the boarding area. That meant that arriving passengers who were simply changing planes had to pass through a security checkpoint before being able to board their connecting flight, along with other passengers whose journeys were originating at Minneapolis–St. Paul. This created excessive waiting times for both sets of passengers. The new layout relocated the security checkpoints, moving them from the boarding area to a position close to the ticket counters. Thus, the need for passengers who were making connecting flights to pass through security was eliminated, and in the process, the waiting time for passengers departing from Minneapolis–St. Paul was considerably reduced.¹

The basic objective of layout design is to facilitate a smooth flow of work, material, and information through the system. Supporting objectives generally involve the following:

- To facilitate attainment of product or service quality.
- To use workers and space efficiently.
- To avoid bottlenecks.
- To minimize material handling costs.
- To eliminate unnecessary movements of workers or materials.
- To minimize production time or customer service time.
- To design for safety.

¹Based on “Airport Checkpoints Moved to Help Speed Travelers on Their Way,” *Minneapolis—St. Paul Star Tribune*, January 13, 1995, p. 1B.

The three basic types of layout are product, process, and fixed-position. *Product layouts* are most conducive to repetitive processing, *process layouts* are used for intermittent processing, and *fixed-position layouts* are used when projects require layouts. The characteristics, advantages, and disadvantages of each layout type are described in this section, along with hybrid layouts, which are combinations of these pure types. These include cellular layouts and flexible manufacturing systems.

Repetitive and Continuous Processing: Product Layouts

Product layouts are used to achieve a smooth and rapid flow of large volumes of goods or customers through a system. This is made possible by highly standardized goods or services that allow highly standardized, repetitive processing. The work is divided into a series of standardized tasks, permitting specialization of equipment and division of labor. The large volumes handled by these systems usually make it economical to invest substantial sums of money in equipment and job design. Because only one or a few very similar items are involved, it is feasible to arrange an entire layout to correspond to the technological processing requirements of the product or service. For instance, if a portion of a manufacturing operation required the sequence of cutting, sanding, and painting, the appropriate pieces of equipment would be arranged in that same sequence. And because each item follows the same sequence of operations, it is often possible to utilize fixed-path material-handling equipment, such as conveyors to transport items between operations. The resulting arrangement forms a line like the one depicted in Figure 6.3. In manufacturing environments, the lines are referred to as **production lines** or **assembly lines**, depending on the type of activity involved. In service processes, the term *line* may or may not be used. It is common to refer to a cafeteria line as such but not a car wash, although from a conceptual standpoint the two are nearly identical. Figure 6.4 illustrates the layout of a typical cafeteria serving line. Examples of this type of layout are less plentiful in service environments because processing requirements usually exhibit too much variability to make standardization feasible. Without high standardization, many of the benefits of repetitive processing are lost. When lines are used, certain compromises may be made. For instance, an automatic car wash provides equal treatment to all cars—the same amount of soap, water, and scrubbing for a given type of wash (e.g., basic wash)—even though cars may differ considerably in cleaning needs.

Product layouts achieve a high degree of labor and equipment utilization, which tends to offset their high equipment costs. Because items move quickly from operation to operation, the amount of work-in-process is often minimal. Consequently, operations are so closely tied to each other that the entire system is highly vulnerable to being shut down because of mechanical failure or high absenteeism. Maintenance procedures are geared to this. *Preventive maintenance*—periodic inspection and replacement of worn parts or those with high failure rates—reduces the probability of breakdowns during the operations. Of course, no amount of preventive activity can completely eliminate failures, so management must take measures to

LO6.6 Describe product layouts and their main advantages and disadvantages.

Product layout Layout that uses standardized processing operations to achieve smooth, rapid, high-volume flow.

Production line Standardized layout arranged according to a fixed sequence of production tasks.

Assembly line Standardized layout arranged according to a fixed sequence of assembly tasks.

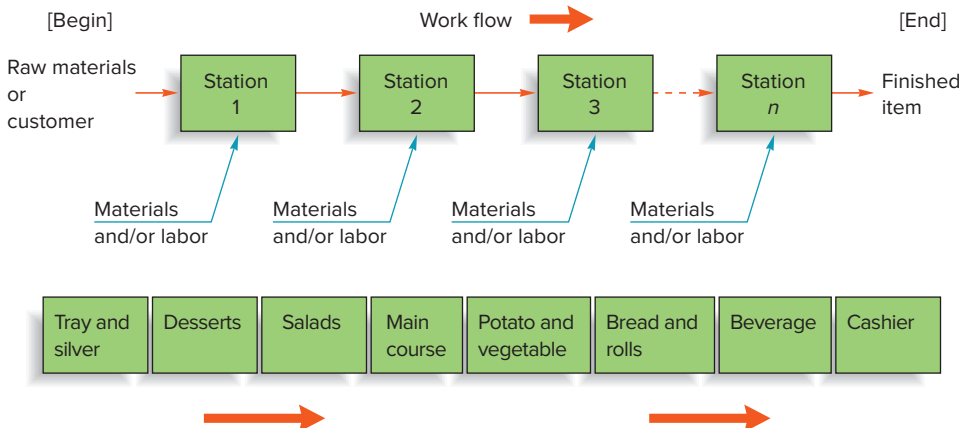

FIGURE 6.3
A flow line for production or service

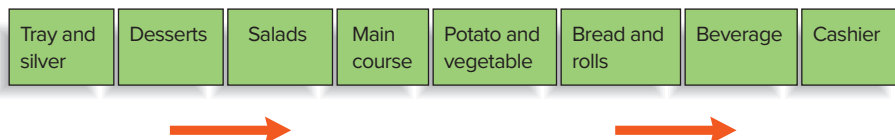
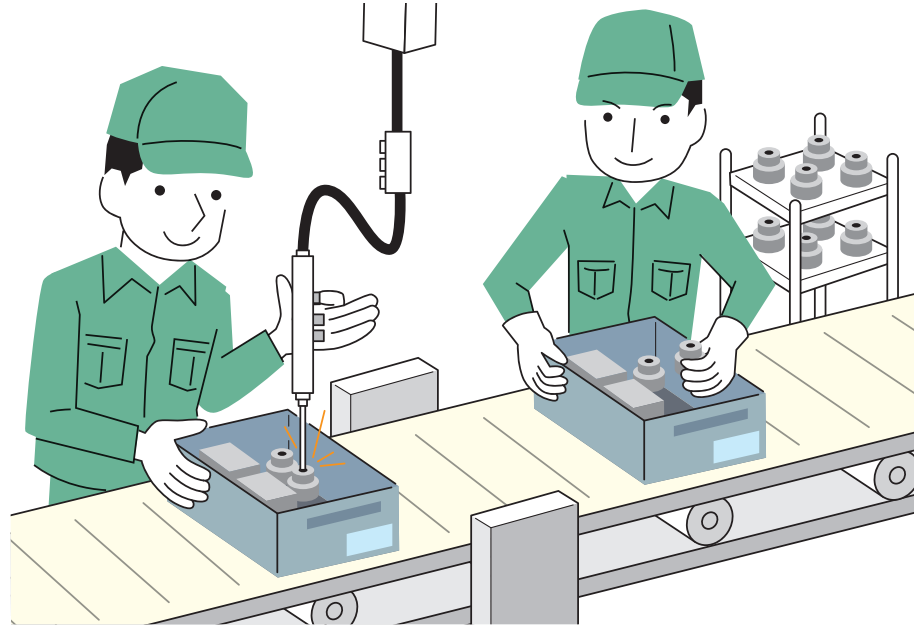

FIGURE 6.4
Cafeteria line

Workers on an assembly line.



poosan/Shutterstock

provide quick repair. These include maintaining an inventory of spare parts and having repair personnel available to quickly restore equipment to normal operation. These procedures are fairly expensive. Because of the specialized nature of equipment, problems become more difficult to diagnose and resolve, and spare-part inventories can be extensive.

Repetitive processing can be machine-paced (e.g., automatic car wash, automobile assembly), worker-paced (e.g., fast-food restaurants such as McDonald's, Burger King), or even customer-paced (e.g., cafeteria line).

The main advantages of product layouts are:

- A high rate of output.
- Low unit cost due to high volume. The high cost of specialized equipment is spread over many units.
- Labor specialization, which reduces training costs and time, and results in a wide span of supervision.
- Low material-handling cost per unit. Material handling is simplified because units follow the same sequence of operations. Material handling is often automated.
- A high utilization of labor and equipment.
- The establishment of routing and scheduling in the initial design of the system. These activities do not require much attention once the system is operating.
- Fairly routine accounting, purchasing, and inventory control.

The primary disadvantages of product layouts include the following:

- The intensive division of labor usually creates dull, repetitive jobs that provide little opportunity for advancement and may lead to morale problems and to repetitive stress injuries.
- Poorly skilled workers may exhibit little interest in maintaining equipment or in the quality of output.
- The system is fairly inflexible in response to changes in the volume of output or changes in product or process design.
- The system is highly susceptible to shutdowns caused by equipment breakdowns or excessive absenteeism because workstations are highly interdependent.

- Preventive maintenance, the capacity for quick repairs, and spare-parts inventories are necessary expenses.
- Incentive plans tied to individual output are impractical because they would cause variations among outputs of individual workers, which would adversely affect the smooth flow of work through the system.

U-Shaped Layouts. Although a straight production line may have intuitive appeal, a U-shaped line (see Figure 6.5) has a number of advantages that make it worthy of consideration. One disadvantage of a long, straight line is that it interferes with cross-travel of workers and vehicles. A U-shaped line is more compact; it often requires approximately half the length of a straight production line. In addition, a U-shaped line permits increased communication among workers on the line because workers are clustered, thus facilitating teamwork. Flexibility in work assignments is increased because workers can handle not only adjacent stations but also stations on opposite sides of the line. Moreover, if materials enter the plant at the same point that finished products leave it, a U-shaped line minimizes material handling.

Of course, not all situations lend themselves to U-shaped layouts: On highly automated lines, there is less need for teamwork and communication, and entry and exit points may be on opposite sides of the building. Also, operations may need to be separated because of noise or contamination factors.

Intermittent Processing: Process Layouts

Process layouts (functional layouts) are designed to process items or provide services that involve a variety of processing requirements. The variety of jobs that are processed requires frequent adjustments to equipment. This causes a discontinuous work flow, which is referred to as **intermittent processing**. The layouts feature departments or other *functional* groupings in which similar kinds of activities are performed. A manufacturing example of a process layout is the *machine shop*, which has separate departments for milling, grinding, drilling, and so on. Items that require those operations are frequently moved in lots or batches to the departments in a sequence that varies from job to job. Consequently, variable-path material-handling equipment (forklift trucks, jeeps, tote boxes) is needed to handle the variety of routes and items. The use of *general-purpose equipment* provides the *flexibility* necessary to handle a wide range of processing requirements. Workers who operate the equipment are usually skilled or semi-skilled. Figure 6.6 illustrates the departmental arrangement typical of a process layout.

LO6.7 Describe process layouts and their main advantages and disadvantages.

Process layouts Layouts that can handle varied processing requirements.

Intermittent processing Non-repetitive processing.

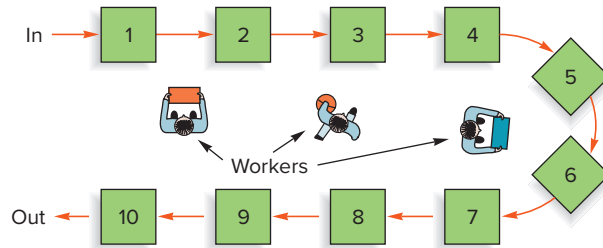

FIGURE 6.5
A U-shaped production line

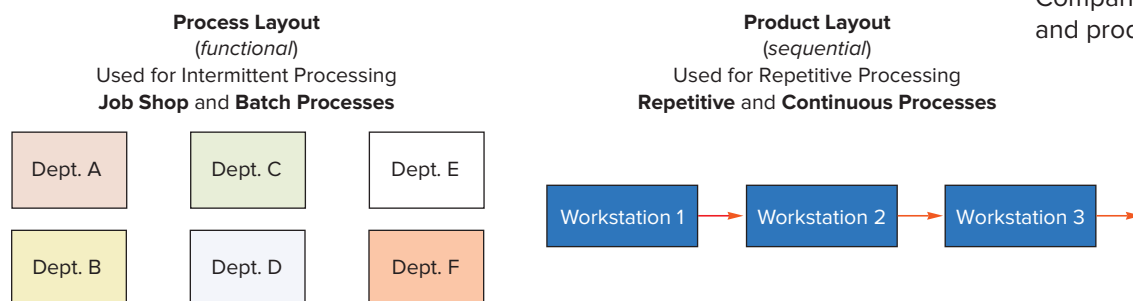

FIGURE 6.6
Comparison of process and product layouts

Process layouts are quite common in service environments. Examples include hospitals, colleges and universities, banks, auto repair shops, airlines, and public libraries. For instance, hospitals have departments or other units that specifically handle surgery, maternity, pediatrics, psychiatric, emergency, and geriatric care. And universities have separate schools or departments that concentrate on one area of study such as business, engineering, science, or math.

Because equipment in a process layout is arranged by type rather than by processing sequence, the system is much less vulnerable to shutdown caused by mechanical failure or absenteeism. In manufacturing systems especially, idle equipment is usually available to replace machines that are temporarily out of service. Moreover, because items are often processed in lots (batches), there is considerably less interdependence between successive operations than with a product layout. Maintenance costs tend to be lower because the equipment is less specialized than that of product layouts, and the grouping of machinery permits repair personnel to become skilled in handling that type of equipment. Machine similarity reduces the necessary investment in spare parts. On the negative side, routing and scheduling must be done on a continual basis to accommodate the variety of processing demands typically imposed on these systems. Material handling is inefficient, and unit handling costs are generally much higher than in product layouts. In-process inventories can be substantial due to batch processing and capacity mismatches. Furthermore, it is not uncommon for such systems to have equipment utilization rates under 50 percent because of routing and scheduling complexities related to the variety of processing demands being handled.

In sum, process layouts have both advantages and disadvantages. The advantages of process layouts include the following:

- The systems can handle a variety of processing requirements.
- The systems are not particularly vulnerable to equipment failures.
- General-purpose equipment is often less costly than the specialized equipment used in product layouts and is easier and less costly to maintain.
- It is possible to use individual incentive systems.

The disadvantages of process layouts include the following:

- In-process inventory costs can be high if batch processing is used in manufacturing systems.
- Routing and scheduling pose continual challenges.
- Equipment utilization rates are low.
- Material handling is slow and inefficient, and more costly per unit than in product layouts.
- Job complexities often reduce the span of supervision and result in higher supervisory costs than with product layouts.
- Special attention necessary for each product or customer (e.g., routing, scheduling, machine setups) and low volumes result in higher unit costs than with product layouts.
- Accounting, inventory control, and purchasing are much more involved than with product layouts.

Fixed-Position Layouts

Fixed-position layout Layout in which the product or project remains stationary, and workers, materials, and equipment are moved as needed.

In **fixed-position layouts**, the item being worked on remains stationary, and workers, materials, and equipment are moved about as needed. This is in marked contrast to product and process layouts. Almost always, the nature of the product dictates this kind of arrangement: Weight, size, bulk, or some other factor makes it undesirable or extremely difficult to move the product. Fixed-position layouts are used in large construction projects (buildings, power plants, dams), shipbuilding, and production of large aircraft and space mission rockets. In those instances, attention is focused on timing of material and equipment deliveries so as not to clog up the work site and to avoid having to relocate materials and equipment around the work site. Lack of storage space can present significant problems, for example, at construction sites in crowded urban locations. Because of the many diverse activities carried out on large projects and because of the wide range of skills required, special efforts are needed to



Alain Denantes/Gamma-Rapho/Getty Images

The *Queen Mary 2* when under construction at the Chantiers de l'Atlantique shipyard in St. Nazaire, France. When a large project must remain stationary, workers and equipment come to the site. The *QM2* weighs 150,000 tons, is 1,132 feet long, and is 147.6 feet wide. Its capacity is 2,620 passengers and 1,253 officers and crew.

coordinate the activities, and the span of control can be quite narrow. For these reasons, the administrative burden is often much higher than it would be under either of the other layout types. Material handling may or may not be a factor; in many cases, there is no tangible product involved (e.g., designing a computerized inventory system). When goods and materials are involved, material handling often resembles process-type, variable-path, general-purpose equipment. Projects might require use of earth-moving equipment and trucks to haul materials to, from, and around the work site, for example.

Fixed-position layouts are widely used in farming, firefighting, road building, home building, remodeling and repair, and drilling for oil. In each case, compelling reasons bring workers, materials, and equipment to the product's location instead of the other way around.

Combination Layouts

The three basic layout types are ideal models, which may be altered to satisfy the needs of a particular situation. It is not hard to find layouts that represent some combination of these pure types. For instance, supermarket layouts are essentially process layouts, yet we find that most use fixed-path material-handling devices such as roller-type conveyors in the stockroom and belt-type conveyors at the cash registers. Hospitals also use the basic process arrangement, although frequently patient care involves more of a fixed-position approach, in which nurses, doctors, medicines, and special equipment are brought to the patient. By the same token, faulty parts made in a product layout may require off-line reworking, which involves customized processing. Moreover, conveyors are frequently observed in both farming and construction activities.

Process layouts and product layouts represent two ends of a continuum from small jobs to continuous production. Process layouts are conducive to the production of a wider range of products or services than product layouts, which is desirable from a customer standpoint where customized products are often in demand. However, process layouts tend to be less efficient and have higher unit production costs than product layouts. Some manufacturers are moving away from process layouts in an effort to capture some of the benefits of product layouts. Ideally, a system is flexible and yet efficient, with low unit production costs. Cellular manufacturing, group technology, and flexible manufacturing systems represent efforts to move toward this ideal.

Cellular Layouts

Cellular production Layout in which workstations are grouped into a cell that can process items that have similar processing requirements.

Cellular Production. Cellular production is a type of layout in which workstations are grouped into what is referred to as a *cell*. Groupings are determined by the operations needed to perform work for a set of similar items, or *part families*, that require similar processing. The cells become, in effect, miniature versions of product layouts. The cells may have no conveyORIZED movement of parts between machines, or they may have a flow line connected by a conveyor (automatic transfer). All parts follow the same route, although minor variations (e.g., skipping an operation) are possible. In contrast, the functional layout involves multiple paths for parts. Moreover, there is little effort or need to identify part families.

Cellular manufacturing enables companies to produce a variety of products with as little waste as possible. A cell layout provides a smooth flow of work through the process with minimal transport or delay. Benefits frequently associated with cellular manufacturing include minimal work in process, reduced space requirements and lead times, productivity and quality improvement, and increased flexibility.

Figure 6.7 provides a comparison between a traditional process layout (6.7A) and a cellular layout (6.7B). To get a sense of the advantage of the cellular layout, trace the movement of an order in the traditional layout (6.7A) that is depicted by the path of the arrow. Begin on the bottom left at Shipping/Receiving, and then follow the arrow to Warehouse, where a batch of raw material is released for production. Follow the path (shown by the arrows) that the batch takes as it moves through the system to Shipping/Receiving and then to the Customer. Now turn to Figure 6.7B. Note the simple path the order takes as it moves through the system.

Several techniques facilitate effective cellular layout design. Among them are the following two:

Single-minute exchange of die (SMED) enables an organization to quickly convert a machine or process to produce a different (but similar) product type. Thus, a single cell can produce a variety of products without the time-consuming equipment changeover associated with large batch processes, enabling the organization to quickly respond to changes in customer demand.

Right-sized equipment is often smaller than equipment used in traditional process layouts, and is mobile, so it can quickly be reconfigured into a different cellular layout in a different location.

Table 6.5 lists the benefits of cellular layouts compared to functional layouts.

The biggest challenges of implementing cellular manufacturing involve issues of equipment and layout and issues of workers and management. Equipment and layout issues relate to design and cost. The costs of work stoppages during implementation can be considerable, as can the costs of new or modified equipment and the rearrangement of the layout. The costs to implement cellular manufacturing must be weighed against the cost savings that can be expected from using cells. Also, the implementation of cell manufacturing often requires employee training and the redefinition of jobs. Each of the workers in each cell should ideally be able to complete the entire range of tasks required in that cell, and often this means being more multiskilled than they were previously. In addition, cells are often expected to be self-managing, and therefore workers will have to be able to work effectively in teams. Managers have to learn to be less involved than with more traditional work methods.

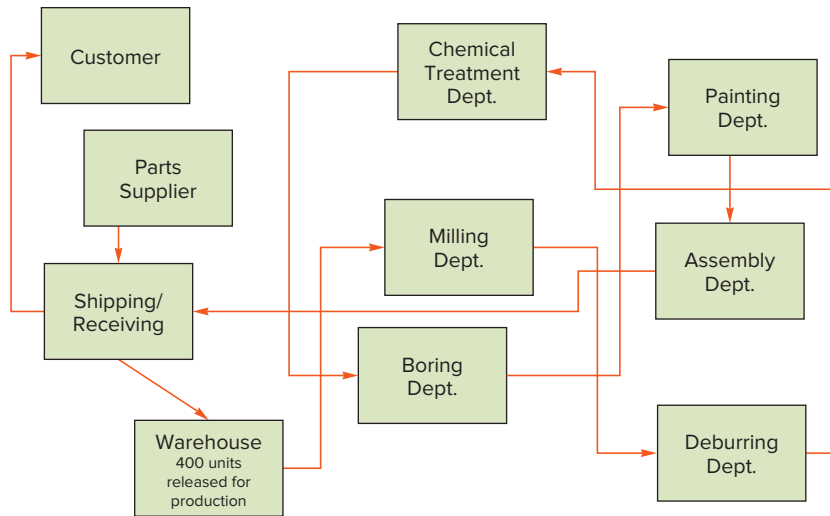

A. Example of an order processed in a traditional process layout.

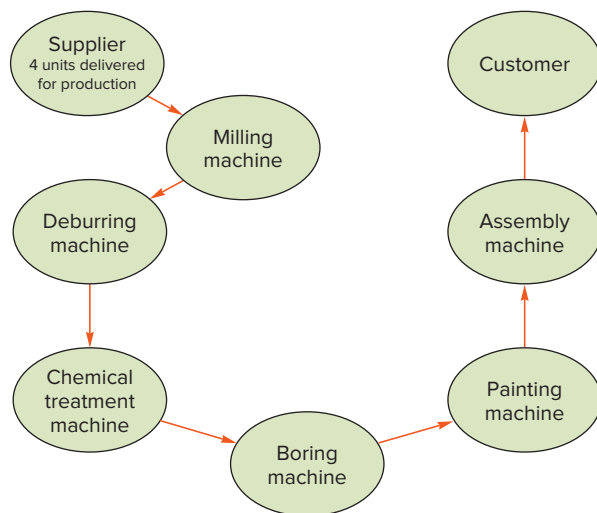

B. The same example of an order processed in a cellular layout.

FIGURE 6.7
Comparison of process and cellular layouts

Source: Adapted from U.S. Environmental Protection Agency, "Lean Manufacturing and the Environment." www.epa.gov/innovation/lean/thinking/cellular.htm

Dimension	Functional	Cellular
Number of moves between departments	Many	Few
Travel distances	Longer	Shorter
Travel paths	Variable	Fixed
Job waiting time	Greater	Shorter
Throughput time	Higher	Lower
Amount of work in process	Higher	Lower
Supervision difficulty	Higher	Lower
Scheduling complexity	Higher	Lower
Equipment utilization	Lower	Higher

TABLE 6.5
A comparison of functional (process) layouts and cellular layouts

Group Technology. Effective cellular manufacturing must have groups of identified items with similar processing characteristics. This strategy for product and process design is known as **group technology** and involves identifying items with similarities in either *design characteristics* or *manufacturing characteristics*, and grouping them into *part families*. Design

Group technology The grouping into part families of items with similar design or manufacturing characteristics.

characteristics include size, shape, and function; manufacturing or processing characteristics involve the type and sequence of operations required. In many cases, design and processing characteristics are correlated, although this is not always the case. Thus, design families may be different from processing families. Figure 6.8 illustrates a group of parts with similar processing characteristics but different design characteristics.

Once similar items have been identified, items can be classified according to their families. Then, a system can be developed that facilitates retrieval from a database for purposes of design and manufacturing. For instance, a designer can use the system to determine if there is an existing part similar or identical to one that needs to be designed. It may happen that an existing part, with some modification, is satisfactory. This greatly enhances the productivity of design. Similarly, planning the manufacturing of a new part can include matching it with one of the part families in existence, thereby alleviating much of the burden of specific processing details.

The conversion to group technology and cellular production requires a systematic analysis of parts to identify the part families. This is often a major undertaking; it is a time-consuming job that involves the analysis of a considerable amount of data. Three primary methods for accomplishing this are visual inspection, examination of design and production data, and production flow analysis.

Visual inspection is the least accurate of the three but also the least costly and the simplest to perform. Examination of design and production data is more accurate but much more time-consuming. It is perhaps the most commonly used method of analysis. Production flow analysis has a manufacturing perspective and not a design perspective, because it examines operations sequences and machine routings to uncover similarities. Moreover, the operation sequences and routings are taken as givens. In reality, the existing procedures may be far from optimal.

Conversion to cellular production can involve costly realignment of equipment. Consequently, a manager must weigh the benefits of a switch from a process layout to a cellular one against the cost of moving equipment, as well as the cost and time needed for grouping parts.

Flexible manufacturing systems, discussed earlier, are more fully automated versions of cellular manufacturing.

Service Layouts

As is the case with manufacturing, service layouts can often be categorized as product, process, or fixed-position layouts. In a fixed-position service layout (e.g., appliance repair, roofing, landscaping, home remodeling, copier service), materials, labor, and equipment are brought to the customer's residence or office. Process layouts are common in services due mainly to the high degree of variety in customer processing requirements. Examples include hospitals, supermarkets and department stores, vehicle repair centers, and banks.

FIGURE 6.8

A group of parts with similar manufacturing process requirements but different design attributes

Mark Dierker/McGraw-Hill Education





No one expects a stay in a hospital room to be unsafe or to have to endure disruptions in their care, but as good and efficient as hospitals are today, there is need for improvement in hospital room safety and patient care. The following are suggestions for an improved hospital room of the future.

- **Double-sided linen closets** allow staff to restock supplies without disturbing the patient.
- **Bar codes** increase safety by matching the right medicine to the right patient.
- **A two-bin supply system** ensures that providers don't run out of critical supplies.
- **A hand-washing station** in every room gives providers a place to wash their hands.
- **A sliding glass door** doubles as a **whiteboard** for information exchanges.
- **Hand bars** on all sides of the bathroom help patients navigate more safely.
- **Bed alarms** alert nurses that a patient may be attempting to get out of bed unassisted.
- **Disinfecting units** use ultra-violet light to kill germs.
- **Checklists** give providers a set of proven rules for preventing infections.
- **Vents** suck the air out of the room of sick patients, filter it, and then release it from the building.
- **"Smart" pumps** deliver fluids, nutrients, and medicines to patients at precisely controlled rates.
- **Kits for fall prevention** include color-coded nonslip socks, a lap blanket, and wristband.
- Frequently touched surfaces, such as IV poles, bed rails and faucets, are made with **germ-resistant copper alloys**, which are naturally antimicrobial.
- **Infrared technology** that lights up the sink reminds health care providers to wash their hands.
- Beds with **translation technology** help staff speak with all patients.
- **Real-time vital signs**—heart rate, blood pressure—can be monitored from computers outside the room.

Questions

1. If you have experienced a hospital room, either as a patient or a visitor, which of these features was present in that room?
2. If you have experienced a hospital room, which of these features was missing, but would have been desirable additions?

Source: "Real Possibilities." *AARP The Magazine*, April/May 2013, p. 54.

If the service is organized sequentially, with all customers or work following the same or similar sequence, as it is in a car wash or a cafeteria line, a product layout is used.

However, service layout requirements are somewhat different from manufacturing layout requirements. The degree of customer contact and the degree of customization are two key factors in service layout design. If contact and customization are both high, as in health care and personal care, the service environment is a job shop, usually with high labor content and flexible equipment, and a layout that supports this. If customization is high but contact low

(e.g., picture framing, tailoring), the layout can be arranged to facilitate workers and equipment. If contact is high but customization is low (e.g., supermarkets, gas stations), self-service is a possibility, in which case layout must take into account the ease of obtaining the service, as well as customer safety. If the degree of contact and the need for customization are low, the core service and the customer can be separated, making it easier to achieve a high degree of efficiency in operations. Highly standardized services may lend themselves to automation (e.g., web services, online banking, ATM machines).

Let's consider some of these layouts.

Warehouse and Storage Layouts. The design of storage facilities presents a different set of factors than the design of factory layouts. Frequency of order is an important consideration. Items that are ordered frequently should be placed near the entrance to the facility, and those ordered infrequently should be placed toward the rear of the facility. Any correlations between items are also significant (i.e., item A is usually ordered with item B), suggesting that placing those two items close together would reduce the cost and time of *picking* (retrieving) those items. Other considerations include the number and widths of aisles, the height of storage racks, rail and/or truck loading and unloading, and the need to periodically make a physical count of stored items.

Retail Layouts. The objectives that guide design of manufacturing layouts often pertain to cost minimization and product flow. However, with retail layouts such as department stores, supermarkets, and specialty stores, designers must take into account the presence of customers and the opportunity to influence sales volume and customer attitudes through carefully designed layouts. Traffic patterns and traffic flow are important factors to consider. Some large retail chains use standard layouts for all or most of their stores. This has several advantages. Most obvious is the ability to save time and money by using one layout instead of

Kiosks benefit customers by speeding up tedious processes and reducing waiting time. At McDonald's, kiosks actually increase sales by an average of \$1 over face-to-face purchases. Managers explain this by the kiosk's ability to prompt customers for more purchases by showing pictures of products they might want to buy.



Quietword/Shutterstock

custom designing one for each store. Another advantage is to avoid confusing consumers who visit more than one store. In the case of service retail outlets, especially small ones such as dry cleaners, shoe repair, and auto service centers, layout design is much simpler.

Office Layouts. Office layouts are undergoing transformations as the flow of paperwork is replaced with the increasing use of electronic communications. This lessens the need to place office workers in a layout that optimizes the physical transfer of information or paperwork. Another trend is to create an image of openness; office walls are giving way to low-rise partitions, which also facilitate communication among workers.

Restaurant Layouts. There are many different types of restaurants, ranging from food trucks to posh establishments. Many belong to chains, and some of those are franchises. That type of restaurant typically adheres to a floor plan established by the company. Independent restaurants and bars have their own floor plans. Some have what could be considered very good designs, while others do not. Ed Norman of MVP Services Group, Inc., in Dubuque, Iowa, offers this valuable observation: “The single most important element is process workflow. Food and non-food products should transition easily through the operation from the receiving door to the customer with all phases of storage, pre-preparation, cooking, holding, and service, unimpaired or minimized due to good design.”

Hospital Layouts. Key elements of hospital layout design are patient care and safety, with easy access to critical resources such as X-ray, CAT scan, and MRI equipment. General layout of the hospital is one aspect of layout, while layout of patient rooms is another. The following reading illustrates a safe hospital room of the future.

Automation in Services. One way to improve productivity and reduce costs in services is to remove the customer from the process as much as possible. Automated services is one increasingly used alternative. For example, financial services use ATMs, automated call answering, online banking, and electronic funds transfers; retail stores use optical



Oleksiy Maksymenko/Getty Images

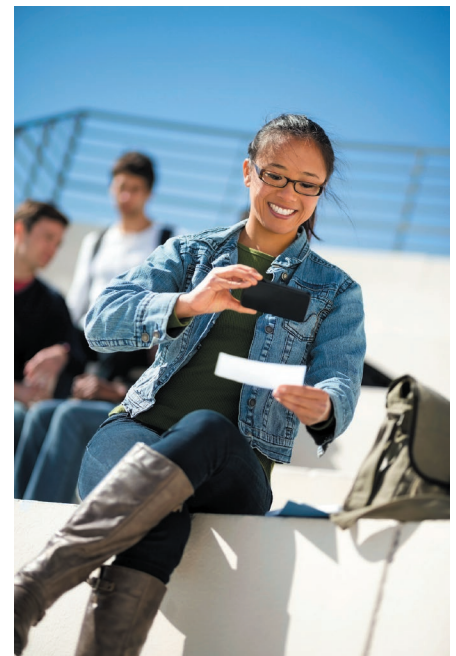

PhotoInc/Getty Images

From self check-in at the airport to depositing a check from anywhere, automation speeds up service and reduces the need to stand in line.

scanning to process sales; and the travel industry uses electronic reservation systems. Other examples of automated services include shipping, mail processing, communication, and health care services.

Automating services means more-standardized services and less need to involve the customer directly. However, service standardization brings trade-offs. Generally, costs are reduced and productivity increases, but the lack of customization and the inability to deal with a real person raise the risk of customer dissatisfaction.

6.6 DESIGNING PRODUCT LAYOUTS: LINE BALANCING

LO6.8 Solve simple line-balancing problems.

The goal of a product layout is to arrange workers or machines in the sequence that operations need to be performed. The sequence is referred to as a production line or an assembly line. These lines range from fairly short, with just a few operations, to long lines that have a large number of operations. Automobile assembly lines are examples of long lines. At the assembly line for Ford Mustangs, a Mustang travels about nine miles from start to finish!

Because it is difficult and costly to change a product layout that is inefficient, design is a critical issue. Many of the benefits of a product layout relate to the ability to divide required work into a series of elemental tasks (e.g., “assemble parts C and D”) that can be performed quickly and routinely by low-skilled workers or specialized equipment. The durations of these elemental tasks typically range from a few seconds to 15 minutes or more. Most time requirements are so brief that it would be impractical to assign only one task to each worker. For one thing, most workers would quickly become bored by the limited job scope. For another, the number of workers required to complete even a simple product or service would be enormous. Instead, tasks are usually grouped into manageable bundles and assigned to workstations staffed by one or two operators.

The process of deciding how to assign tasks to workstations is referred to as **line balancing**. The goal of line balancing is to obtain task groupings that represent approximately equal time requirements. This minimizes the idle time along the line and results in a high utilization of labor and equipment. Idle time occurs if task times are not equal among workstations; some stations are capable of producing at higher rates than others. These “fast” stations will experience periodic waits for the output from slower stations or else be forced into idleness to avoid buildups of work between stations. Unbalanced lines are undesirable in terms of inefficient utilization of labor and equipment and because they may create morale problems at the slower stations for workers who must work continuously.

Lines that are perfectly balanced will have a smooth flow of work as activities along the line are synchronized to achieve maximum utilization of labor and equipment. The major obstacle to attaining a perfectly balanced line is the difficulty of forming task bundles that have the same duration. One cause of this is that it may not be feasible to combine certain activities into the same bundle, either because of differences in equipment requirements or because the activities are not compatible (e.g., risk of contamination of paint from sanding). Another cause of difficulty is that differences among elemental task lengths cannot always be overcome by grouping tasks. A third cause of an inability to perfectly balance a line is that a required technological sequence may prohibit otherwise desirable task combinations. Consider a series of three operations that have durations of two minutes, four minutes, and two minutes, as shown in the following diagram. Ideally, the first and third operations could be combined at one workstation and have a total time equal to that of the second operation. However, it may not be possible to combine the first and third operations. In the case of an automatic car wash, scrubbing and drying operations could not realistically be combined at the same workstation due to the need to rinse cars between the two operations.

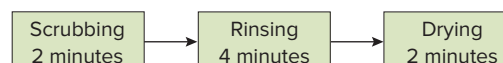

Line balancing The process of assigning tasks to workstations in such a way that the workstations have approximately equal time requirements.

Line balancing involves assigning tasks to workstations. Usually, each workstation has one worker who handles all of the tasks at that station, although an option is to have several workers at a single workstation. For purposes of illustration, however, all of the examples and problems in this chapter have workstations with one worker. A manager could decide to use anywhere from one to five workstations to handle five tasks. With one workstation, all tasks would be done at that station; with five stations, for example, one task would be assigned to each station. If two, three, or four workstations are used, some or all of the stations will have multiple tasks assigned to them. How does a manager decide how many stations to use?

The primary determinant is what the line's **cycle time** will be. The cycle time is the *maximum* time allowed at each workstation to perform assigned tasks before the work moves on. The cycle time also establishes the output rate of a line. For instance, if the cycle time is two minutes, units will come off the end of the line at the rate of one every two minutes. Hence, the line's capacity is a function of its cycle time.

We can gain some insight into task groupings and cycle time by considering a simple example.

Suppose that the work required to fabricate a certain product can be divided up into five elemental tasks, with the task times and precedence relationships, as shown in the following diagram:

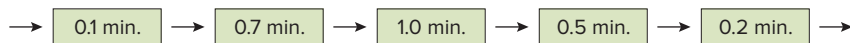

The task times govern the range of possible cycle times. The *minimum* cycle time is equal to the *longest* task time (1.0 minute), and the *maximum* cycle time is equal to the sum of the task times ($0.1 + 0.7 + 1.0 + 0.5 + 0.2 = 2.5$ minutes). The minimum cycle time would apply if there were five workstations. The maximum cycle time would apply if all tasks were performed at a single workstation. The minimum and maximum cycle times are important because they establish the potential range of output for the line, which we can compute using the following formula:

$$\text{Output rate} = \frac{\text{Operating time per day}}{\text{Cycle time}} \quad (6-1)$$

Assume that the line will operate for eight hours per day (480 minutes). With a cycle time of 1.0 minute, output would be

$$\frac{480 \text{ minutes per day}}{1.0 \text{ minute per unit}} = 480 \text{ units per day}$$

With a cycle time of 2.5 minutes, the output would be

$$\frac{480 \text{ minutes per day}}{2.5 \text{ minute per unit}} = 192 \text{ units per day}$$

Assuming that no parallel activities are to be employed (e.g., two lines), the output selected for the line must fall in the range of 192 units per day to 480 units per day.

As a general rule, the cycle time is determined by the desired output; that is, a desired output rate is selected, and the cycle time is computed. If the cycle time does not fall between the maximum and minimum bounds, the desired output rate must be revised. We can compute the cycle time using this equation:

$$\text{Cycle time} = \frac{\text{Operating time per day}}{\text{Desired output rate}} \quad (6-2)$$

Cycle time The maximum time allowed at each workstation to complete its set of tasks on a unit.

For example, suppose that the desired output rate is 480 units. Using Formula 6–2, the necessary cycle time is

$$\frac{480 \text{ minutes per day}}{480 \text{ units per day}} = 1.0 \text{ minute per unit}$$

The number of workstations that will be needed is a function of both the desired output rate and our ability to combine elemental tasks into workstations. We can determine the *theoretical minimum* number of stations necessary to provide a specified rate of output as follows:

$$N_{\min} = \frac{\sum t}{\text{Cycle time}} \quad (6-3)$$

where

N_{\min} = Theoretical minimum number of stations

$\sum t$ = Sum of task times

Suppose the desired rate of output is the maximum of 480 units per day.² (This will require a cycle time of 1.0 minute.) The minimum number of stations required to achieve this goal is

$$N_{\min} = \frac{2.5 \text{ minutes per unit}}{1 \text{ minute per unit per station}} = 2.5 \text{ stations}$$

Because 2.5 stations is not feasible, it is necessary to *round up* (because 2.5 is the minimum) to three stations. Thus, the actual number of stations used will equal or exceed three, depending on how successfully the tasks can be grouped into workstations.

Precedence diagram A diagram that shows elemental tasks and their precedence requirements.

A very useful tool in line balancing is a **precedence diagram**. Figure 6.9 illustrates a simple precedence diagram. It visually portrays the tasks to be performed, along with the *sequential* requirements—that is, the *order* in which tasks must be performed. The diagram is read from left to right, so the initial task(s) are on the left and the final task is on the right. In terms of precedence requirements, we can see from the diagram, for example, that the only requirement to begin task *b* is that task *a* must be finished. However, in order to begin task *d*, tasks *b* and *c* must *both* be finished. Note that the elemental tasks are the same ones we have been using.

Now let's see how a line is balanced. This involves assigning tasks to workstations. Generally, no techniques are available that guarantee an optimal set of assignments. Instead, managers employ *heuristic (intuitive) rules*, which provide good and sometimes optimal sets of assignments. A number of line-balancing heuristics are in use, two of which are described here for purposes of illustration:

1. Assign tasks in order of most following tasks.
2. Assign tasks in order of greatest positional weight. Positional weight is the sum of each task's time and the times of all following tasks.

FIGURE 6.9

A simple precedence diagram

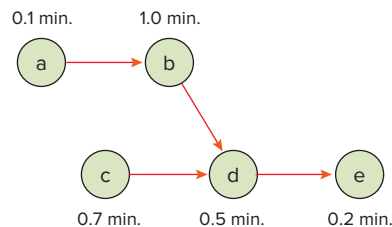

²At first glance, it might seem that the desired output would logically be the maximum possible output. However, you will see why that is not always the best alternative.

Assigning Tasks According to Greatest Number of Following Tasks

Arrange the tasks shown in Figure 6.9 into three workstations. Use a cycle time of 1.0 minute. Assign tasks in order of the greatest number of followers.

EXAMPLE 1



SOLUTION

1. Begin with task *a*; it has the most following tasks. Assign it to workstation 1.
2. Tasks *b* and *c* each have two following tasks, but only task *c* will fit in the time remaining at workstation 1, so assign task *c* to workstation 1.
3. Task *b* now has the most followers, but it will not fit at workstation 1, so assign it to workstation 2.
4. There is no time left at workstation 2, so we move on to workstation 3, assigning task *d* and then task *e* to that workstation.

Workstation	Time Remaining	Eligible	Assign Task	Revised Time Remaining	Station Idle Time
1	1.0	a, c	a	0.9	
	0.9	b, c	c	0.2	
	0.2	none	—		0.2
2	1.0	b	b	0.0	0.0
3	1.0	d	d	0.5	
	0.5	e	e	0.3	
	0.3	—	—		0.3 0.5

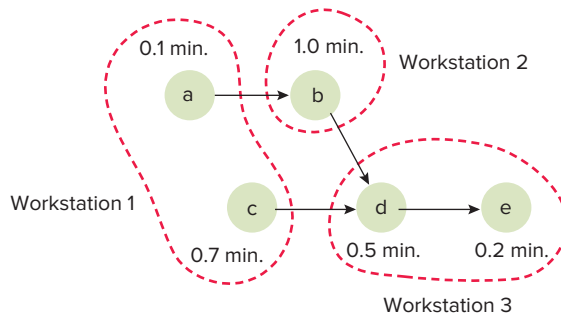

The initial “time remaining” for each workstation is equal to the cycle time. For a task to be eligible, tasks preceding it must have been assigned, and the task’s time must not exceed the station’s remaining time.

Example 1 has been made purposely simple to illustrate the basic procedure. Later examples will illustrate tiebreaking, constructing precedence diagrams, and the positional weight method. Before considering those examples, let us first consider some measures of effectiveness that can be used for evaluating a given set of assignments.

Two widely used measures of effectiveness are

1. The **percentage of idle time** of the line. This is sometimes referred to as the **balance delay**. It can be computed as follows:

Balance delay Percentage of idle time of a line.

$$\text{Percentage of idle time} = \frac{\text{Idle time per cycle}}{N_{\text{actual}} \times \text{Cycle time}} \times 100 \tag{6-4}$$

where

N_{actual} = Actual number of stations

For the preceding example, the value is

$$\text{Percentage of idle time} = \frac{.5}{3 \times 1.0} \times 100 = 16.7\%$$

In effect, this is the average idle time divided by the cycle time, multiplied by 100. Note that cycle time refers to the actual cycle time that is achieved. When the calculated cycle time in Formula 6-2 and the actual bottleneck station time differ, the actual bottleneck station time should be used in all idle time, efficiency, and output (throughput) calculations. The actual bottleneck time dictates the actual pace of the line, whereas the calculated cycle time is just an upper limit on the amount of time that can be loaded into any station.

2. The **efficiency** of the line. This is computed as follows:

$$\text{Efficiency} = 100\% - \text{Percent idle time} \quad (6-5a)$$

Here, Efficiency = 100% - 16.7% = 83.3%. Alternatively, efficiency could be computed using Formula 6-5b:

$$\text{Efficiency} = \frac{N_{\text{actual}} \times \text{Cycle time} - \text{Idle time}}{N_{\text{actual}} \times \text{Cycle time}} \times 100 \quad (6-5b)$$

Now let's consider the question of whether the selected level of output should equal the maximum output possible. The minimum number of workstations needed is a function of the desired output rate and, therefore, the cycle time. Thus, a lower rate of output (hence, a longer cycle time) may result in a need for fewer stations. Hence, the manager must consider whether the potential savings realized by having fewer workstations would be greater than the decrease in profit resulting from producing fewer units.

The preceding examples serve to illustrate some of the fundamental concepts of line balancing. They are rather simple, but in most real-life situations, the number of branches and tasks is often much greater. Consequently, the job of line balancing can be a good deal more complex. In many instances, the number of alternatives for grouping tasks is so great that it is virtually impossible to conduct an exhaustive review of all possibilities. For this reason, many real-life problems of any magnitude are solved using heuristic approaches. The purpose of a heuristic approach is to reduce the number of alternatives that must be considered, but it does not guarantee an optimal solution.

Some Guidelines for Line Balancing

In balancing an assembly line, tasks are assigned *one at a time* to the line, starting at the first workstation. At each step, the unassigned tasks are checked to determine which are eligible for assignment. Next, the eligible tasks are checked to see which of them will fit in the workstation being loaded. A heuristic is used to select one of the tasks that will fit, and the task is assigned. This process is repeated until there are no eligible tasks that will fit. Then, the next workstation can be loaded. This continues until all tasks are assigned. The objective is to minimize the idle time for the line subject to technological and output constraints.

Technological constraints tell us which elemental tasks are *eligible* to be assigned at a particular position on the line. Technological constraints can result from the precedence or ordering relationships among the tasks. The precedence relationships require that certain tasks must be performed before others (and so they must be assigned to workstations before others). Thus, in a car wash, the rinsing operation must be performed before the drying operation. The drying operation is not eligible for assignment until the rinsing operation has been assigned. Technological constraints may also result from two tasks being incompatible (e.g., space restrictions or the nature of the operations may prevent their being placed in the same work center). For example, sanding and painting operations would not be assigned to the same work center because dust particles from the sanding operation could contaminate the paint.

Output constraints, on the other hand, determine the maximum amount of work that a manager can assign to each workstation, and this determines whether an eligible task *will fit* at a workstation. The desired output rate determines the cycle time, and the sum of the task

times assigned to any workstation must not exceed the cycle time. If a task can be assigned to a workstation without exceeding the cycle time, then the task will fit.

Once it is known which tasks are *eligible* and *will fit*, the manager can select the task to be assigned (if there is more than one to choose from). This is where the heuristic rules help us decide which task to assign from among those that are eligible and will fit.

To clarify the terminology, *following tasks* are all tasks that you would encounter by following all paths from the task in question through the precedence diagram. *Preceding tasks* are all tasks you would encounter by tracing all paths *backward* from the task in question. In the following precedence diagram, tasks *b*, *d*, *e*, and *f* are followers of task *a*. Tasks *a*, *b*, and *c* are preceding tasks for *e*.

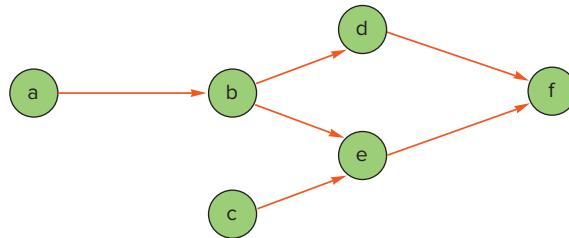

The *positional weight* for a task is the sum of the task times for itself and all its following tasks.

Neither of the heuristics *guarantees* the *best* solution, or even a good solution to the line-balancing problem, but they do provide guidelines for developing a solution. It may be useful to apply several different heuristics to the same problem and pick the best (least idle time) solution out of those developed.

Drawing a Precedence Diagram, Computing Cycle Time and the Minimum Number of Workstations Needed, and Assigning Tasks Using Greatest Number of Following Tasks

EXAMPLE 2

excel
mhhe.com/stevenson14e

Using the information contained in the table shown, do each of the following:

1. Draw a precedence diagram.
2. Assuming an eight-hour workday, compute the cycle time needed to obtain an output of 400 units per day.
3. Determine the minimum number of workstations required.
4. Assign tasks to workstations using this rule: Assign tasks according to greatest number of following tasks. In case of a tie, use the tiebreaker of assigning the task with the longest processing time first.

Task	Immediate Predecessor	Task Time (in minutes)
a	—	0.2
b	a	0.2
c	—	0.8
d	c	0.6
e	b	0.3
f	d, e	1.0
g	f	0.4
h	g	0.3

$$\sum t = 3.8$$

5. Compute the resulting percent idle time and efficiency of the system.

SOLUTION

- Drawing a precedence diagram is a relatively straightforward task. Begin with activities with no predecessors. We see from the list that tasks *a* and *c* do not have predecessors. We build from here.

Step 1:



Step 2: Task *b* follows *a*, and *d* follows *c*.



Step 3: Task *e* follows *b*.



Step 4: Task *f* follows *e*, and *d*.



Step 5: Task *g* follows *f*, and *h* follows *g*.

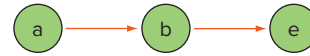

- Cycle time = $\frac{\text{Operating time}}{\text{Desired output rate}} = \frac{480 \text{ minutes per day}}{400 \text{ units per day}} = 1.2 \text{ minutes per cycle}$
- $N_{\min} = \frac{\sum t}{\text{Cycle time}} = \frac{3.8 \text{ minutes per unit}}{1.2 \text{ minutes per cycle per station}} = 3.17 \text{ stations (round to 4)}$
- Beginning with station 1, make assignments following this procedure: Determine from the precedence diagram which tasks are eligible for assignment. Then determine which of the eligible tasks will fit the time remaining for the station. Use the tiebreaker if necessary. Once a task has been assigned, remove it from consideration. When a station cannot take any more assignments, go on to the next station. Continue until all tasks have been assigned.

Station	Time Remaining	Eligible	Will Fit	Assign (task time)	Revised Time Remaining	Idle
1	1.2	a, c*	a, c*	a (0.2)		
	1.0	c, b**	c, b**	c (0.8)	0.2	
	0.2	b, d	b	b (0.2)	0.0	
	0	e, d	None	—		0.0
2	1.2	e, d	e, d	d (0.6)	0.6	
	0.6	e	e	e (0.3)	0.3	
	0.3***	f	None	—		0.3
3	1.2	f	f	f (1.0)	0.2	
	0.2	g	None	—		0.2
4	1.2	g	g	g (0.4)	0.8	
	0.8	h	h	h (0.3)	0.5	
	0.5	—	—	—		0.5
						1.0 min.

*Neither *a* nor *c* has any predecessors, so both are eligible. Task *a* was assigned since it has more followers.
 **Once *a* is assigned, *b* and *c* are now eligible. Both will fit in the time remaining of 1.0 minute. The tie cannot be broken by the "most followers" rule, so the longer task is assigned.
 ***Although *f* is eligible, this task will not fit, so station 2 is left with 0.3 minute of idle time per 1.2-minute cycle.

These assignments are shown in the following diagram. *Note:* One should not expect that heuristic approaches will always produce optimal solutions; they merely provide a practical way to deal with complex problems that may not lend themselves to optimizing techniques. Moreover, different heuristics often yield different answers. Note, though, that when the N_{\min} number of stations is used, the efficiency cannot be improved.

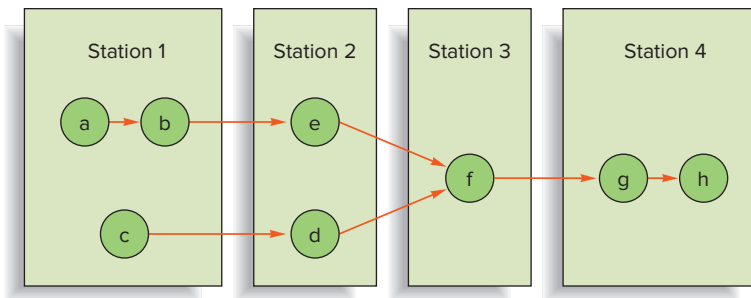

5. Percent idle time = $\frac{1.0 \text{ min.}}{4 \times 1.2 \text{ min.}} \times 100 = 20.83\%$
 Efficiency = $100\% - 20.83\% = 79.17\%$

Other Factors

The preceding discussion on line balancing presents a relatively straightforward approach to approximating a balanced line. In practice, the ability to do this usually involves additional considerations, some of which are technical.

Technical considerations include skill requirements of different tasks. If skill requirements of tasks are quite different, it may not be feasible to place the tasks in the same workstation. Similarly, if the tasks themselves are incompatible (e.g., the use of fire and flammable liquids), it may not be feasible even to place them in stations that are near each other.

Developing a workable plan for balancing a line may also require consideration of human factors as well as equipment and space limitations.

Although it is convenient to treat assembly operations as if they occur at the same rate time after time, it is more realistic to assume that whenever humans are involved, task completion times will be variable. The reasons for the variations are numerous, including fatigue, boredom, and failure to concentrate on the task at hand. Absenteeism also can affect line balance. Minor variability can be dealt with by allowing some slack along the line. However, if more variability is inherent in even a few tasks, that will severely impact the ability to achieve a balanced line.

For these reasons, lines that involve human tasks are more of an ideal than a reality. In practice, lines are rarely perfectly balanced. However, this is not entirely bad, because some unbalance means that slack exists at points along the line, which can reduce the impact of brief stoppages at some workstations. Also, workstations that have slack can be used for new workers who may not be “up to speed.”

Other Approaches

Companies use a number of other approaches to achieve a smooth flow of production. One approach is to use *parallel workstations*. These are beneficial for bottleneck operations which would otherwise disrupt the flow of product as it moves down the line. The bottlenecks may be the result of difficult or very long tasks. Parallel workstations increase the work flow and provide flexibility.



BMW'S STRATEGY: FLEXIBILITY

The assembly line in Dingolfing, Germany, where BMW assembles its 7-Series, has built-in flexibility that allows it to easily produce multiple models. Rival car producers typically configure their assembly lines to produce just a single model at a time. In order for them to produce a different model, the line must be shut down

so that it can be changed over to be able to produce the different model. BMW's production flexibility enables its line to easily respond to market fluctuations while avoiding the costly changeovers that its rivals' more rigid lines require.

Source: Based on "Betting on the S," *The Wall Street Journal*, July 11, 2005, p. B1.

Consider this example.³ A job has four tasks; task times are 1 minute, 1 minute, 2 minutes, and 1 minute. The cycle time for the line would be 2 minutes, and the output rate would be 30 units per hour:

$$\frac{60 \text{ minutes per hour}}{2 \text{ minutes per unit}} = 30 \text{ units per hour}$$

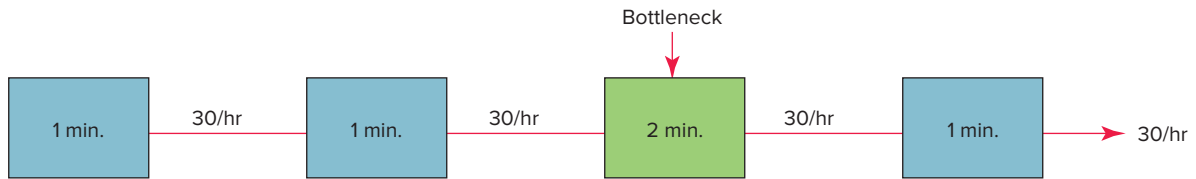

Using parallel stations for the third task would result in a cycle time of 1 minute because the output rate at the parallel stations would be equal to that of a single station and allow an output rate for the line of 60 units per hour:

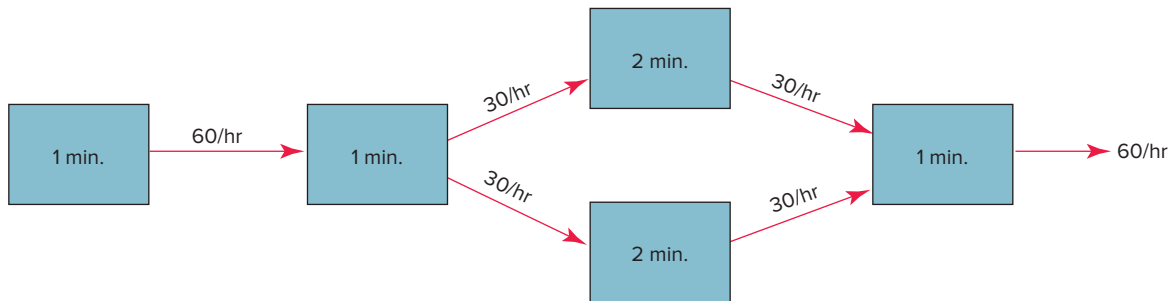

Another approach to achieving a balanced line is to *cross-train* workers so that they are able to perform more than one task. Then, when bottlenecks occur, the workers with temporarily increased idle time can assist other workers who are temporarily overburdened, thereby maintaining an even flow of work along the line. This is sometimes referred to as *dynamic line balancing*, and it is used most often in lean production systems.

Still another approach is to design a line to handle more than one product on the same line. This is referred to as a *mixed model line*. Naturally, the products have to be fairly similar, so that the tasks involved are pretty much the same for all products. This approach offers great flexibility in varying the amount of output of the products. The reading above describes one such line.

³Adapted from Mikell P. Groover, *Automation, Production Systems, and Computer-Aided Manufacturing*, 2nd ed. 1987. Pearson Education, Inc., Upper Saddle River, NJ.

6.7 DESIGNING PROCESS LAYOUTS

LO6.9 Develop simple process layouts.

The main issue in designing process layouts concerns the relative positioning of the departments involved. As illustrated in Figure 6.10, departments must be assigned to locations. The problem is to develop a reasonably good layout; some combinations will be more desirable than others. For example, some departments may benefit from adjacent locations, whereas others should be separated. A lab with delicate equipment would not be located near a department that had equipment with strong vibrations. Conversely, two departments that share some of the same equipment would benefit from being close together.

Layouts can also be influenced by external factors such as the location of entrances, loading docks, elevators, windows, and areas of reinforced flooring. Also important are noise levels, safety, and the size and locations of restrooms.

In some instances (e.g., the layouts of supermarkets, gas stations, and fast-food chains), a sufficient number of installations having similar characteristics justify the development of standardized layouts. For example, the use of the same basic patterns in McDonald's fast-food locations facilitates construction of new structures and employee training. Food preparation, order taking, and customer service follow the same pattern throughout the chain. Installation and service of equipment are also standardized. This same concept has been successfully employed in computer software products such as Microsoft Windows and the Macintosh Operating System. Different applications are designed with certain basic features in common, so that a user familiar with one application can readily use other applications without having to start from scratch with each new application.

The majority of layout problems involve single rather than multiple locations, and they present unique combinations of factors that do not lend themselves to a standardized approach. Consequently, these layouts require customized designs.

A major obstacle to finding the most efficient layout of departments is the large number of possible assignments. For example, there are more than 87 billion different ways that 14 departments can be assigned to 14 locations if the locations form a single line. Different location configurations (e.g., 14 departments in a 2×7 grid) often reduce the number of possibilities, as do special requirements (e.g., the stamping department may have to be assigned to a location with reinforced flooring). Still, the remaining number of layout possibilities is quite large. Unfortunately, no algorithms exist to identify the best layout arrangement under all circumstances. Often, planners must rely on heuristic rules to guide trial-and-error efforts for a satisfactory solution to each problem.

Measures of Effectiveness

One advantage of process layouts is their ability to satisfy a variety of processing requirements. Customers or materials in these systems require different operations and different sequences of operations, which cause them to follow different paths through the system. Material-oriented systems necessitate the use of variable-path material-handling equipment to move materials from work center to work center. In customer-oriented systems, people must travel or be transported from work center to work center. In both cases, transportation costs or time can be significant. Because of this factor, one of the major objectives in process layout is to minimize transportation cost, distance, or time. This is usually accomplished by locating departments with relatively high interdepartmental work flow as close together as possible.

Locations			Work centers to be assigned
A	B	C	1
			2
			3
D	E	F	4
			5
			6

FIGURE 6.10
Work centers must be assigned to locations

Other concerns in choosing among alternative layouts include initial costs in setting up the layout, expected operating costs, the amount of effective capacity created, and the ease of modifying the system.

In situations that call for improvement of an existing layout, costs of relocating any work center must be weighed against the potential benefits of the move.

Information Requirements

The design of process layouts requires the following information:

- A list of departments or work centers to be arranged, their approximate dimensions, and the dimensions of the building or buildings that will house the departments.
- A projection of future work flows between the various work centers.
- The distance between locations and the cost per unit of distance to move loads between locations.
- The amount of money to be invested in the layout.
- A list of any special considerations (e.g., operations that must be close to each other or operations that must be separated).
- The location of key utilities, access and exit points, loading docks, and so on, in existing buildings.

The ideal situation is to first develop a layout and then design the physical structure around it, thus permitting maximum flexibility in design. This procedure is commonly followed when new facilities are constructed. Nonetheless, many layouts must be developed in existing structures where floor space, the dimensions of the building, location of entrances and elevators, and other similar factors must be carefully weighed in designing the layout. Note that multilevel structures pose special problems for layout planners.

Minimizing Transportation Costs or Distances

The most common goals in designing process layouts are minimization of transportation costs or distances traveled. In such cases, it can be very helpful to summarize the necessary data in *from-to charts* like those illustrated in Tables 6.6 and 6.7. Table 6.6 indicates the distance between each of the locations, and Table 6.7 indicates actual or projected work flow between each pair. For instance, the distance chart reveals that a trip from location A to location B will involve a distance of 20 meters. (Distances are often measured between department centers.) Oddly enough, the length of a trip between locations A and B may differ depending on the *direction* of the trip—due to one-way routes, elevators, or other factors. To simplify the discussion, assume a constant distance between any two locations regardless of direction. However, it is not realistic to assume that interdepartmental work flows are equal—there is no reason to suspect that department 1 will send as much work to department 2 as department 2 sends to 1. For example, several departments may send goods to packaging, but packaging may send only to the shipping department.

Transportation costs can also be summarized in from-to charts, but we shall avoid that complexity, assuming instead that costs are a direct, linear function of distance.

TABLE 6.6

Distance between locations (meters)

From \ To	LOCATION		
	A	B	C
A		20	40
B			30
C			

TABLE 6.7

Interdepartmental work flow (loads per day)

From \ To	DEPARTMENT		
	1	2	3
Dept.	1	30	170
	2		100
	3		

Assigning Locations That Minimize Transportation Cost

Assign the three departments shown in Table 6.7 to locations A, B, and C (which are separated by the distances shown in Table 6.6) in such a way that transportation cost is minimized. Note that Table 6.7 summarizes the flows in both directions. Use this heuristic: Assign departments with the greatest interdepartmental work flow first to locations that are closest to each other.

EXAMPLE 3

excel
mhhe.com/stevenson14e

Ranking departments according to highest work flow and ranking locations according to highest inter-location distances helps in making assignments.

SOLUTION

Trip	Distance (meters)	Department Pair	Work Flow
A-B	20	1-3	170
B-C	30	2-3	100
A-C	40	1-2	30

From these listings, you can see that departments 1 and 3 have the highest interdepartmental work flow, and that locations A and B are the closest. Thus, it seems reasonable to consider assigning 1 and 3 to locations A and B, although it is not yet obvious which department should be assigned to which location. Further inspection of the work flow list reveals that 2 and 3 have higher work flow than 1 and 2, so 2 and 3 should probably be located more closely than 1 and 2. Hence, it would seem reasonable to place 3 between 1 and 2, or at least centralize that department with respect to the other two. The resulting assignments might appear as illustrated in Figure 6.11.

If the cost per meter to move any load is \$1, you can compute the total daily transportation cost for this assignment by multiplying each department's number of loads by the trip distance, and summing those quantities:

Department	Number of Loads Between	Location	Distance To:	Loads \times Distance
1	2: 30	A	C: 40	$30 \times 40 = 1,200$
	3: 170		B: 20	$170 \times 20 = 3,400$
2	3: 100	C	B: 30	$100 \times 30 = 3,000$
				7,600

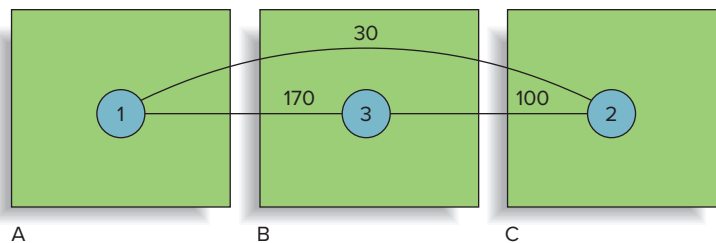

FIGURE 6.11

Interdepartmental work flows for assigned departments

At \$1 per load meter, the cost for this plan is \$7,600 per day. Even though it might appear that this arrangement yields the lowest transportation cost, you cannot be absolutely positive of that without actually computing the total cost for every alternative and comparing it to this one. Instead, rely on the choice of reasonable heuristic rules, such as those demonstrated previously to arrive at a satisfactory, if not optimal, solution.

Closeness Ratings

Although the preceding approach is widely used, it suffers from the limitation of focusing on only one objective, and many situations involve multiple criteria. Richard Muther developed a more general approach to the problem, which allows for subjective input from analysis or managers to indicate the relative importance of each combination of department pairs.⁴ That information is then summarized in a grid like that shown in Figure 6.12. Read the grid in the same way as you would read a mileage chart on a road map, except that letters rather than distances appear at the intersections. The letters represent the importance of closeness for each department pair, with A being the most important and X being an undesirable pairing. Thus, in the grid it is “absolutely necessary” to locate 1 and 2 close to each other because there is an A at the intersection of those departments on the grid. On the other hand, 1 and 4 should not be close together because their intersection has an X. In practice, the letters on the grid are often accompanied by numbers that indicate the reason for each assignment (they are omitted here to simplify the illustration). Muther suggests the following list:

- They use the same equipment or facilities.
- They share the same personnel or records.
- Required sequence of work flow.
- Needed for ease of communication.
- Would create unsafe or unpleasant conditions.
- Similar work is performed.

FIGURE 6.12
A muther grid

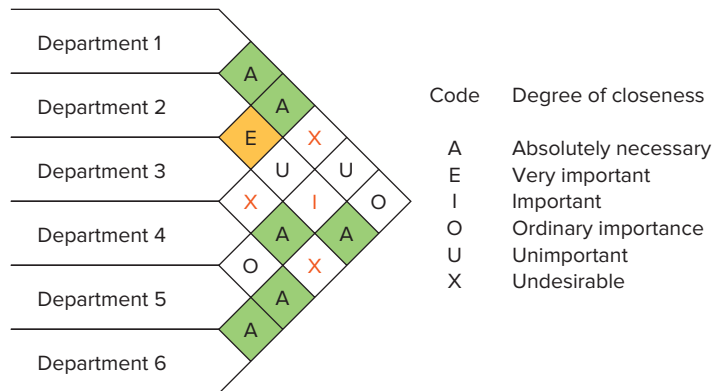

EXAMPLE 4

Assign Departments in Order of Criticalness

Assign the six departments in Figure 6.12 to a 2 × 3 set of locations using the heuristic rule: Assign critical departments first, because they are the most important.

SOLUTION

Critical pairs of departments are those with A or X ratings. Prepare a list of those by referring to the grid:

A Links	X Links
1–2	1–4
1–3	3–6
2–6	3–4
3–5	
4–6	
5–6	

⁴Richard Muther and John Wheeler, “Simplified Systematic Layout Planning.” *Factory* 120, nos. 8, 9, and 10 (August, September, October 1962), pp. 68–77, 111–119, 101–113, respectively.

Next, form a cluster of A links, beginning with the department that appears most frequently in the A list (in this case, 6). For instance:

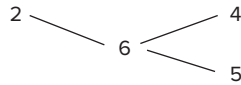

Take the remaining A links in order, and add them to this main cluster where possible, rearranging the cluster as necessary. Form separate clusters for departments that do not link with the main cluster. In this case, all link with the main cluster.

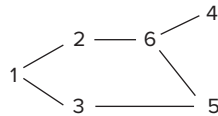

Next, graphically portray the X links:

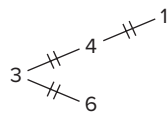

Observe that, as it stands, the cluster of A links also satisfies the X separations. It is a fairly simple exercise to fit the cluster into a 2 × 3 arrangement:

1	2	6
3	5	4

Note that the lower-level ratings have also been satisfied with this arrangement, even though no attempt was made to explicitly consider the E and I ratings. Naturally, not every problem will yield the same results, so it may be necessary to do some additional adjusting to see if improvements can be made, keeping in mind that the A and X assignments deserve the greatest consideration.

Note that departments are considered close not only when they touch side to side but also when they touch corner to corner.

The value of this rating approach is that it permits the use of multiple objectives and subjective inputs. Its limitations relate to the use of subjective inputs in general: They are imprecise and unreliable.

Process selection choices often have strategic implications for organizations. They can affect cost, quality, productivity, customer satisfaction, and competitive advantage. Process types include job shop, batch processing, repetitive processing, continuous processing, and projects. Process type determines how work is organized, and it has implications for the entire organization and its supply chain. Process type and layout are closely related. Except for projects, process selection is usually a function of the volume and variety needed.

Layout decisions are an important aspect of the design of operations systems, affecting operating costs and efficiency. Layout decisions are often closely related to process selection decisions.

Product layouts are geared to high-volume output of standardized items. Workers and equipment are arranged according to the technological sequence required by the product or service involved. Emphasis in design is on work flow through the system, and specialized processing and handling equipment is often used. Product layouts are highly vulnerable to breakdowns. Preventive maintenance is used to reduce the occurrence of breakdowns. Software is available for large or complex designs.

Process layouts group similar activities into departments or other work centers. These systems can handle a wide range of processing requirements and are less susceptible to breakdowns. However, the variety of processing requirements necessitates continual routing and scheduling and the use of

SUMMARY

variable-path material-handling equipment. The rate of output is generally much lower than that of product layouts.

Fixed-position layouts are used when size, fragility, cost, or other factors make it undesirable or impractical to move a product through a system. Instead, workers, equipment, and materials are brought to the product.

The main design efforts in product layout development focus on dividing up the work required to produce a product or service into a series of tasks that are as nearly equal as possible. The goal is to achieve a high degree of utilization of labor and equipment. In process layout, design efforts often focus on the relative positioning of departments to minimize transportation costs or to meet other requirements concerning the proximity of certain department pairs.

The large number of possible alternatives to layout problems prevents an examination of each one. Instead, heuristic rules guide the discovery of alternatives. The solutions thus obtained are usually satisfactory, although not necessarily optimal. Software packages are available to reduce the effort required to obtain solutions to layout problems, but these too rely largely on heuristic methods.

KEY POINTS

1. Process choice is demand-driven.
2. Process type and layout are a function of expected demand volume and the degree of customization that will be needed.
3. Each process type and layout type has advantages and limitations that should be clearly understood when making process selection and layout decisions.
4. Process design is critical in a product-focused system, whereas managing is critical in a process-focused system.

KEY TERMS

3D printing, 257	cycle time, 273	precedence diagram, 274
assembly line, 261	fixed-position layout, 264	process layout, 263
automation, 253	flexible manufacturing system (FMS), 255	production line, 261
balance delay, 275	group technology, 267	product layout, 261
cellular production, 266	intermittent processing, 263	product or service profiling, 252
computer-aided manufacturing (CAM), 254	line balancing, 272	project, 249
computer-integrated manufacturing (CIM), 256	numerically controlled (N/C) machines, 254	technological innovation, 252
		technology, 252

SOLVED PROBLEMS

Problem 1 The tasks shown in the following precedence diagram are to be assigned to workstations with the intent of minimizing idle time. Management has designed an output rate of 275 units per day. Assume 440 minutes are available per day.

- Determine the appropriate cycle time.
- What is the minimum number of stations possible?
- Assign tasks using the “positional weight” rule: Assign tasks with highest following times (including a task’s own time) first. Break ties using the greatest number of following tasks.
- Compute efficiency.

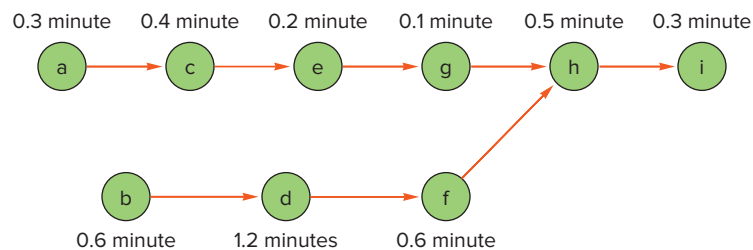

Solution

a. $\text{Cycle time} = \frac{\text{Operating time}}{\text{Desired output}} = \frac{440 \text{ minutes per day}}{275 \text{ units per day}} = 1.6 \text{ minutes per unit}$

b. $N = \frac{\sum t_i}{\text{Cycle time}} = \frac{4.2}{1.6 \text{ minutes}} = 2.625 \text{ (round to 3)}$

c. Add positional weights (task time plus the sum of all following times) to the diagram. Start at the right end and work backward:

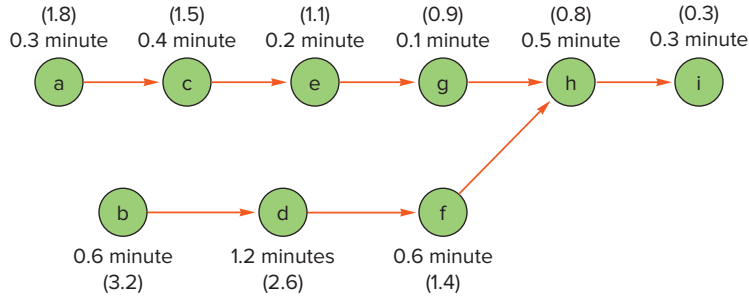

Station	Time Remaining*	Eligible	Will Fit	Assign Task/Time	Station Idle Time
1	1.6	a, b	a, b	b/0.6	0
	1.0	a, d	a	a/0.3	
	0.7	c, d	c	c/0.4	
	0.3	e, d	e	e/0.2	
	0.1	g, d	g	g/0.1	
	0	—	—	—	
2	1.6	d	d	d/1.2	0.4
	0.4	f	none	none	
3	1.6	f	f	f/0.6	0.2
	1.0	h	h	h/0.5	
	0.5	i	i	i/0.3	
	0.2	—	—	—	
					0.6

*The initial time for each station is the cycle time computed in part a.

The resulting assignments are shown as follows.

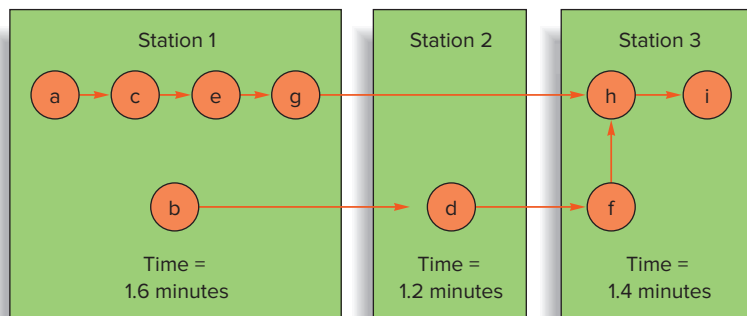

d. $\text{Efficiency} = 100\% - \text{Percent idle time} = 100\% - \frac{0.6 \text{ min.}}{3 \times 1.6 \text{ min.}} 100 = 87.5\%$

Problem 2 Assign nine automobile service departments to bays in a 3×3 grid so that the closeness ratings in the following matrix are satisfied. (The unimportant and ordinary-importance ratings have been omitted to simplify the example.) The location of department 4 must be in the upper right-hand corner of the grid to satisfy a town ordinance.

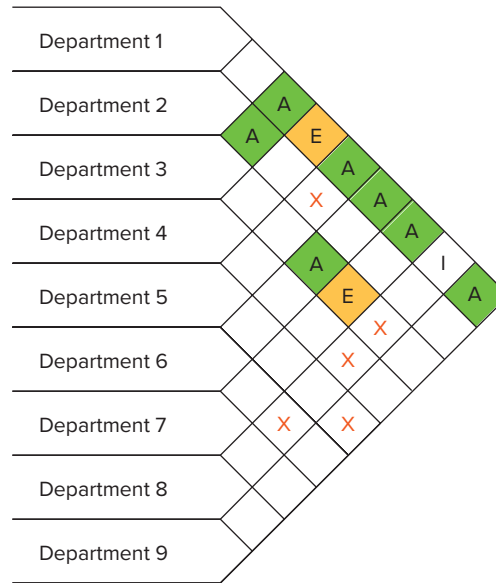

Solution Note that department 1 has many A ratings, making it a strong candidate for the center position in the grid. We can form a cluster of departments that should be close together:

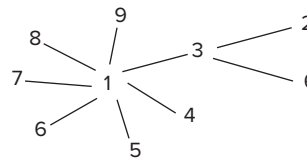

Next, we can identify departmental pairings that should be avoided:

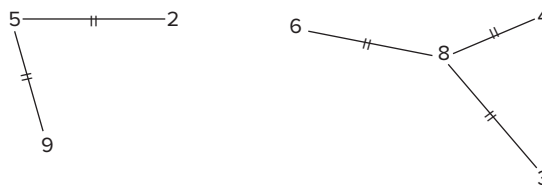

These departments should be spaced around the perimeter of the grid. After a bit of trial and error, the final grid shown below emerged. Check it against the rating matrix to see if it satisfies the ratings.

2	3	4
9	1	6
8	7	5

Five departments are to be assigned to locations B through F in the grid. (For technical reasons, department 6 must be assigned to location A.) Transportation cost is \$2 per foot. The objective is to minimize total transportation cost. Information on interdepartmental work flows and distances between locations is shown in the following tables. Assign departments with the greatest interdepartmental work flow first.

Problem 3

		DISTANCE BETWEEN LOCATIONS (FEET)					
From	To	A	B	C	D	E	F
A		—	50	100	50	80	130
B			—	50	90	40	70
C				—	140	60	50
D					—	50	120
E						—	50
F							—

		NUMBER OF TRIPS PER DAY BETWEEN CENTERS					
From	To	1	2	3	4	5	6
1		—	125	62	64	25	50
2			—	10	17	26	54
3				—	2	0	20
4					—	13	2
5						—	5
6							—

A Dept. 6	B	C
D	E	F

First, either rank or arrange the work flows from high to low. Here, they have been arranged from high to low.

Solution

Dept.	Work Flow	Dept.	Work Flow
1-2	125	2-4	17
1-4	64	4-5	13
1-3	62	2-3	10
2-6	54	5-6	5
1-6	50	3-4	2
2-5	26	4-6	2
1-5	25	3-5	0
3-6	20		

From this, we can see that departments 1 and 2 have the greatest interdepartmental work flow, so they should be close, perhaps at B and E. Next, work flows for 1–3 and 1–4 are high. Note, though, that the work flow for 3–4 is low, suggesting that they need not be close. Instead, we would place them on either side of department 1. Note also that 3–4 is only 2, 3–5 is 0, while 3–6 is 20 and 4–5 is 13. Hence, place department 3 at location D, department 4 at location F, and department 5 at location C.

A Dept. 6	B Dept. 2	C Dept. 5	Total cost:			
D Dept. 3	E Dept. 1	F Dept. 4	Trip	b Distance	c Frequency	(b × c × \$2) Cost
			1–2	(B–E) 40	125	\$10,000
			1–3	(D–E) 50	62	6,200
			1–4	(F–E) 50	64	6,400
			1–5	(E–C) 60	25	3,000
			1–6	(A–E) 80	50	8,000
			2–3	(B–D) 90	10	1,800
			2–4	(B–F) 70	17	2,380
			2–5	(B–C) 50	26	2,600
			2–6	(A–B) 50	54	5,400
			3–4	(F–D) 120	2	480
			3–5	(D–C) 140	0	0
			3–6	(A–D) 50	20	2,000
			4–5	(C–F) 50	13	1,300
			4–6	(A–F) 130	2	520
			5–6	(A–C) 100	5	1,000
						<u>\$51,080</u>

DISCUSSION AND REVIEW QUESTIONS

1. Explain the importance of process selection in system design.
2. Briefly describe the five process types, and indicate the kinds of situations in which each would be used.
3. Briefly discuss the advantages and disadvantages of automation.
4. Briefly describe computer-assisted approaches to production.
5. What is a flexible manufacturing system, and under what set of circumstances is it most appropriate?
6. Why is management of technology important?
7. Why might the choice of equipment that provides flexibility sometimes be viewed as a management cop-out?
8. What are the trade-offs that occur when a process layout is used? What are the trade-offs that occur when a product layout is used?
9. List some common reasons for redesigning layouts.
10. Briefly describe the two main layout types.
11. What are the main advantages of a product layout? The main disadvantages?
12. What are the main advantages of a process layout? The main disadvantages?
13. What is the goal of line balancing? What happens if a line is unbalanced?
14. Why are routing and scheduling continual problems in process layouts?
15. Compare equipment maintenance strategies in product and process layouts.
16. Briefly outline the impact that job sequence has on each of the layout types.

17. The City Transportation Planning Committee must decide whether to begin a long-term project to build a subway system or to upgrade the present bus service. Suppose you are an expert in fixed-path and variable-path material-handling equipment, and the committee seeks your counsel on this matter. What are the advantages and limitations of the subway and bus systems?
18. Identify the fixed-path and variable-path material-handling equipment commonly found in supermarkets.
19. What are heuristic approaches, and why are they used in designing layouts?
20. Why are product layouts atypical in service environments?
21. According to a study by the Alliance of American Insurers, it costs more than three times the original purchase price in parts and labor to reconstruct a wrecked Chevrolet. Explain the reasons for this large discrepancy in terms of the processes used to assemble the original car and those required to reconstruct the wrecked car.
22. Name some ways that a layout can help or hinder productivity.
23. What is cellular manufacturing? What are its main benefits and limitations?
24. What is group technology?
25. Explain the consequences of task time variability on line balancing.

1. Name three major trade-offs in process selection.
2. What trade-offs are involved when deciding how often to rebalance an assembly line?
3. Who needs to be involved in process selection?
4. Who needs to be involved in layout design?
5. In what ways does technology have an impact on process selection? How can technology impact layout decisions?

1. Name two unethical behaviors related to process selection and two related to layout, and the ethical principles they violate (see Chapter 1).
2. Layout decisions affect a wide range of facilities, from factories, supermarkets, offices, department stores, and warehouses, to malls, parking lots and garages, and kitchens. Layout is also important in the design of some products such as the interiors of automobiles and the arrangement of components inside computers and other electronic devices. Select three different items from this list, or other similar items, and explain for each what the four or five key considerations for layout design are.
3. What are the risks of automating a production process? What are the risks for a service process?
4. Consider an assembly line such as the burrito assembly line at Chipotle Mexican Grill. During slow times of the day, one server can handle assembly, but during very busy times, having many servers would be prudent. Explain why either approach wouldn't work all the time, and the benefit of matching the number of servers to the pace of customer arrivals.

1. An assembly line with 17 tasks is to be balanced. The longest task is 2.4 minutes, and the total time for all tasks is 18 minutes. The line will operate for 450 minutes per day.
 - a. What are the minimum and maximum cycle times?
 - b. What range of output is theoretically possible for the line?
 - c. What is the minimum number of workstations needed if the maximum output rate is to be sought?
 - d. What cycle time will provide an output rate of 125 units per day?
 - e. What output potential will result if the cycle time is (1) 9 minutes? (2) 15 minutes?
2. A manager wants to assign tasks to workstations as efficiently as possible and achieve an hourly output of $33\frac{1}{3}$ units. Assume the shop works a 60-minute hour. Assign the tasks shown in the accompanying precedence diagram (times are in minutes) to workstations using the following rules:
 - a. In order of most following tasks. Tiebreaker: greatest positional weight.
 - b. In order of greatest positional weight. Tiebreaker: most following tasks.
 - c. What is the efficiency?

TAKING STOCK

CRITICAL THINKING EXERCISES

PROBLEMS

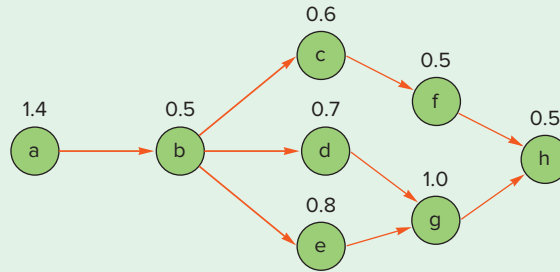

3. A manager wants to assign tasks to workstations as efficiently as possible and achieve an hourly output of four units. The department uses a working time of 56 minutes per hour. Assign the tasks shown in the accompanying precedence diagram (times are in minutes) to workstations using the following rules:
 - a. In order of most following tasks. Tiebreaker: greatest positional weight.
 - b. In order of greatest positional weight. Tiebreaker: most following tasks.
 - c. What is the efficiency?

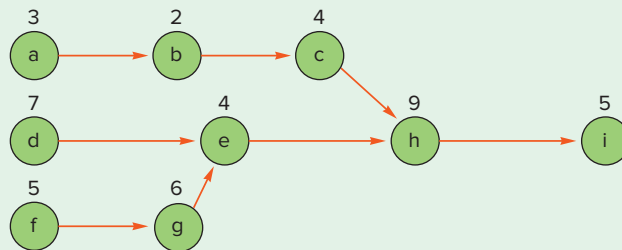

4. A producer of inkjet printers is planning to add a new line of printers, and you have been asked to balance the process, given the following task times and precedence relationships. Assume that cycle time is to be the minimum possible.

Task	Length (minutes)	Immediate (Predecessor)
a	0.2	–
b	0.4	a
c	0.3	–
d	1.3	b, c
e	0.1	–
f	0.8	e
g	0.3	d, f
h	1.2	g

- a. Do each of the following:
 - (1) Draw the precedence diagram.
 - (2) Assign tasks to stations in order of most following tasks. Tiebreaker: greatest positional weight.
 - (3) Determine the percentage of idle time.
 - (4) Compute the rate of output in printers per day that could be expected for this line, assuming a 420-minute working day.
- b. Answer these questions:
 - (1) What is the shortest cycle time that will permit use of only two workstations? Is this cycle time feasible? Identify the tasks you would assign to each station.
 - (2) Determine the percentage of idle time that would result if two stations were used.
 - (3) What is the daily output under this arrangement?
 - (4) Determine the output rate that would be associated with the maximum cycle time.

5. As part of a major plant renovation project, the industrial engineering department has been asked to balance a revised assembly operation to achieve an output of 240 units per eight-hour day. Task times and precedence relationships are as follows:

Task	Duration (minutes)	Immediate (Predecessor)
a	0.2	—
b	0.4	a
c	0.2	b
d	0.4	—
e	1.2	d
f	1.2	c
g	1.0	e, f

Do each of the following:

- Draw the precedence diagram.
 - Determine the minimum cycle time, the maximum cycle time, and the calculated cycle time.
 - Determine the minimum number of stations needed.
 - Assign tasks to workstations on the basis of most following tasks. Use shortest processing time as a tiebreaker. If ties still exist, assume indifference in choice.
 - Compute the percentage of idle time for the assignment in part *d*.
6. Twelve tasks, with times and precedence requirements as shown in the following table, are to be assigned to workstations using a cycle time of 1.5 minutes. Two heuristic rules will be tried: (1) greatest positional weight, and (2) most following tasks. In each case, the tiebreaker will be the shortest processing time.

Task	Length (minutes)	Immediate Predecessor
a	0.1	—
b	0.2	a
c	0.9	b
d	0.6	c
e	0.1	—
f	0.2	d, e
g	0.4	f
h	0.1	g
i	0.2	h
j	0.7	i
k	0.3	j
l	0.2	k

- Draw the precedence diagram for this line.
 - Assign tasks to stations under each of the two rules.
 - Compute the percentage of idle time for each rule.
7. For the given set of tasks, do the following:
- Develop the precedence diagram.
 - Determine the minimum cycle time and then calculate the cycle time for a desired output of 500 units in a seven-hour day. Why might a manager use a cycle time of 50 seconds?
 - Determine the minimum number of workstations for output of 500 units per day.

- d. Balance the line using the *greatest positional weight* heuristic. Break ties with the *most following tasks* heuristic. Use a cycle time of 50 seconds.
- e. Calculate the percentage idle time for the line.

Task	Task Time (seconds)	Immediate Predecessor
A	45	—
B	11	A
C	9	B
D	50	—
E	26	D
F	11	E
G	12	C
H	10	C
I	9	F, G, H
J	10	I
	<u>193</u>	

- 8. A shop works a 400-minute day. The manager of the shop wants an output of 200 units per day for the assembly line that has the elemental tasks shown in the table. Do the following:
 - a. Construct the precedence diagram.
 - b. Assign tasks according to the *most following tasks* rule. Break ties with the *greatest positional weight* rule.
 - c. Assign tasks according to the *greatest positional weight* rule. Break ties with the *most following tasks* rule.
 - d. Compute the balance delay for each rule. Which one yields the better set of assignments in this instance?

Task	Immediate Predecessor	Task Time
a	—	0.5
b	a	1.4
c	a	1.2
d	a	0.7
e	b, c	0.5
f	d	1.0
g	e	0.4
h	g	0.3
i	f	0.5
j	e, i	0.8
k	h, j	0.9
m	k	0.3

- 9. Arrange six departments into a 2 × 3 grid so that these conditions are satisfied: 1 close to 2, 5 close to 2 and 6, 2 close to 5, and 3 not close to 1 or 2.
- 10. Using the information given in the preceding problem, develop a Muther-type grid using the letters A, O, and X. Assume that any pair of combinations not mentioned have an O rating.
- 11. Using the information in the following grid, determine if the department locations shown are appropriate. If not, modify the assignments so the conditions are satisfied.

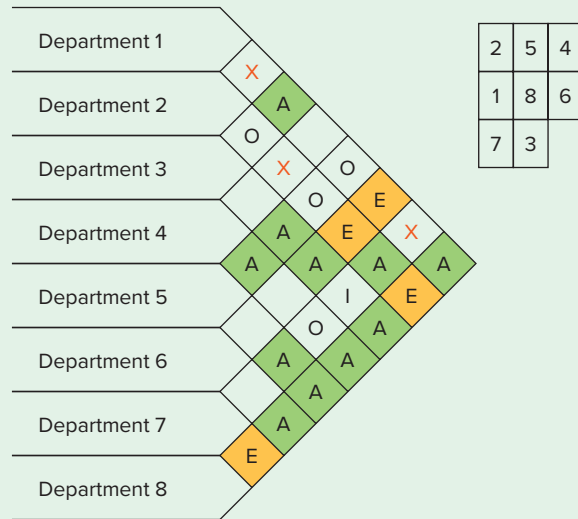

12. Arrange the eight departments shown in the accompanying Muther grid into a 2 × 4 format. *Note:* Department 1 must be in the location shown.

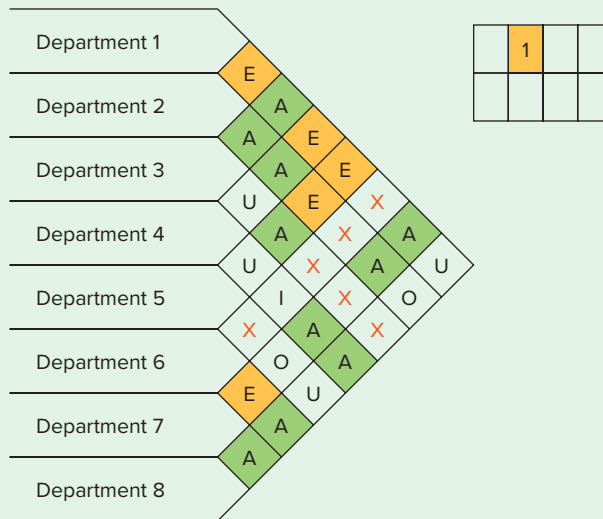

13. Arrange the departments so they satisfy the conditions shown in the following rating grid into a 3 × 3 format. Place department 5 in the lower left corner of the 3 × 3 grid.

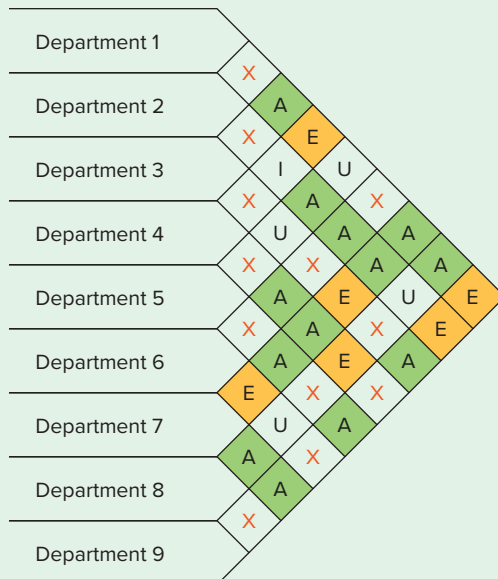

14. a. Determine the placement of departments for a newly designed facility that will minimize total transportation costs using the data in the following tables. Assume that reverse distances are the same. The locations are shown in the grid. Use a cost of \$1 per trip yard.

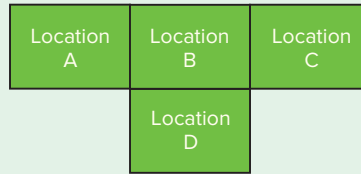

		DISTANCE BETWEEN LOCATIONS (yards)						NUMBER OF TRIPS PER DAY BETWEEN DEPARTMENTS			
From	To	1	2	3	4	From	To	1	2	3	4
A		—	40	80	70	1		—	10	20	80
B			—	40	50	2			—	40	90
C				—	60	3				—	55
D					—	4					—

- b. Suppose the company has revised its plans for the processes described in part a to accommodate technological process changes. Determine the placement of departments that will now minimize total travel cost. Use the distances shown in part a, but use the following new matrix of daily trips between departments.

		NUMBER OF TRIPS PER DAY BETWEEN DEPARTMENTS			
From	To	A	B	C	D
1		—	20	20	40
2			—	10	50
3				—	60
4					—

15. Eight work centers must be arranged in an L-shaped building. The locations of centers 1 and 3 are assigned as shown in the accompanying diagram. Assuming transportation costs are \$1 per load per meter, develop a suitable layout that minimizes transportation costs using the given information. Compute the total cost. (Assume the reverse distances are the same.)

		DISTANCE (meters)							
From	To	A	B	C	D	E	F	G	H
A		—	40	40	60	120	80	100	110
B			—	60	40	60	140	120	130
C				—	45	85	40	70	90
D					—	40	50	40	45
E						—	90	50	40
F							—	40	60
G								—	40
H									—

A 1	B
C	D
F	G
	H
	E 3

		LOADS PER DAY							
From	To	1	2	3	4	5	6	7	8
1		—	10	5	90	370	135	125	0
2			—	360	120	40	115	45	120
3				—	350	110	40	20	200
4					—	190	70	50	190
5						—	10	40	10
6							—	50	20
7								—	20
8									—

16. Develop a process layout that will minimize the total distance traveled by patients at a medical clinic, using the following information on projected departmental visits by patients and distance between locations. Assume a distance of 35 feet between the reception area and each potential location. Use the format shown.

		DISTANCE BETWEEN LOCATIONS (feet)					
From	To	A	B	C	D	E	F
A		—	40	80	100	120	160
B			—	40	60	80	120
C				—	20	40	80
D					—	20	40
E						—	40
F							—

		TRIPS BETWEEN DEPARTMENTS (per day)						
	To	Reception	1	2	3	4	5	6
Reception		—	20	50	210	20	10	130
1		10	—	0	40	110	80	50
2		40		—	0	50	40	120
3		10			—	10	250	10
4		0				—	40	90
5		10					—	20
6		30						—

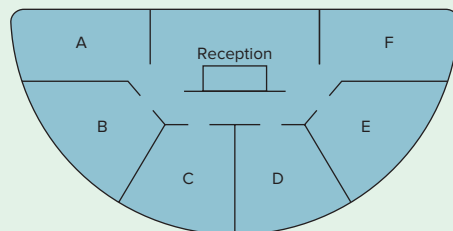

17. Ten labs will be assigned to the circular layout shown. Recalling a similar layout’s congestion in the halls, the new lab manager has requested an assignment that will minimize traffic between offices. Department 1 must be at location A. Develop a suitable layout using the following information.

		NUMBER OF TRIPS PER DAY BETWEEN DEPARTMENTS									
From	TO	1	2	3	4	5	6	7	8	9	10
1		—	40	51	26	23	9	20	12	11	35
2			—	37	16	27	15	18	18	18	36
3				—	18	20	14	50	18	25	36
4					—	35	14	14	22	23	31
5						—	24	14	13	21	25
6							—	17	44	42	25
7								—	14	33	40
8									—	43	35
9										—	47
10											—

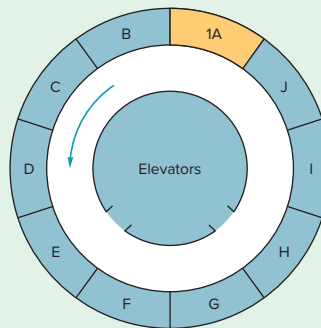

18. Rebalance the assembly line in Problem 7. This time, use the *longest operation time* heuristic. Break ties with the *most following tasks* heuristic. What is the percentage idle time for your line?

SELECTED BIBLIOGRAPHY AND FURTHER READINGS

Francis, Richard L., Leon F. McGinnis Jr., and John A. White. *Facility Layout and Location: An Analytical Approach*, 3rd ed. Upper Saddle River, NJ: Prentice Hall, 2001.

Groover, Mikell P. *Automation, Production Systems, and Computer-Aided Manufacturing*, 3rd ed. Upper Saddle River, NJ: Prentice Hall, 2007.

Pinto, J. *A Short History of Automation Growth*. JimPinto.com

Stephens, Matthew P., and Fred E. Meyers. *Manufacturing Facilities Design & Material Handling*, 5th ed. West Lafayette, IN: Purdue University Press, 2013.

Zijlstra, Emma, and Mark P. Mobach. “The Influence of Facility Layout on Operations Explored.” *Journal of Facilities Management* 9 (2011), pp. 127–144.

7

Work Design and Measurement

CHAPTER

LEARNING OBJECTIVES

After completing this chapter, you should be able to:

- LO7.1** Explain the importance of work design.
- LO7.2** Compare and contrast the two basic approaches to job design.
- LO7.3** Discuss the advantages and disadvantages of specialization.
- LO7.4** Describe behavioral approaches to job design.
- LO7.5** Discuss the impact of working conditions on job design.
- LO7.6** Compare the advantages and disadvantages of time-based and output-based pay systems.
- LO7.7** Explain the purpose of methods analysis and describe how methods studies are performed.
- LO7.8** Describe four commonly used techniques for motion study.
- LO7.9** Define a standard time.
- LO7.10** Describe and compare time study methods and perform calculations.
- LO7.11** Describe work sampling and perform calculations.
- LO7.12** Compare stopwatch time study and work sampling.

CHAPTER OUTLINE

- | | | |
|---|-------------------------------------|------------------------------------|
| 7.1 Introduction 301 | 7.3 Quality of Work Life 305 | Standard Elemental Times 322 |
| 7.2 Job Design 301 | Working Conditions 306 | Predetermined Time Standards 323 |
| Specialization 302 | Compensation 308 | Work Sampling 323 |
| Behavioral Approaches to Job Design 303 | 7.4 Methods Analysis 310 | |
| Motivation 303 | 7.5 Motion Study 315 | 7.7 Operations Strategy 327 |
| Teams 303 | 7.6 Work Measurement 316 | |
| Ergonomics 305 | Stopwatch Time Study 317 | |



Photodisc/Getty Images

This chapter has four major sections: job design, quality of work life, methods analysis, and work measurement.

As you read this chapter, note how decisions in other design areas have an impact on work design. For example, product or service design decisions in large measure determine the kinds of activities workers will be involved with. Similarly, layout decisions often influence work design. Process layouts tend to necessitate broader job content than product layouts. The implication of these interrelationships is that it is essential to adopt a systems (“big picture”) approach to design; decisions in one area must be related to the overall system.

7.1 INTRODUCTION

The importance of work design is underscored by an organization’s dependence on human efforts (i.e., work) to accomplish its goals. Furthermore, many of the topics in this chapter are especially relevant for productivity improvement and continuous improvement.

7.2 JOB DESIGN

Job design involves specifying the content and methods of jobs. Job designers focus on *what* will be done in a job, *who* will do the job, *how* the job will be done, and *where* the job will be done. The objectives of job design include productivity, safety, and quality of work life.

LO7.1 Explain the importance of work design.

Job design The act of specifying the contents and methods of jobs.

LO7.2 Compare and contrast the two basic approaches to job design.

Current practice in job design contains elements of two basic schools of thought. One might be called the *efficiency* school because it emphasizes a systematic, logical approach to job design; the other is called the *behavioral* school because it emphasizes satisfaction of wants and needs.

The efficiency approach, a refinement of Frederick Winslow Taylor's scientific management concepts, received considerable emphasis in the past. The behavioral approach followed and has continued to make inroads into many aspects of job design. It is noteworthy that specialization is a primary issue of disagreement between the efficiency and behavioral approaches.

LO7.3 Discuss the advantages and disadvantages of specialization.

Specialization Work that concentrates on some aspect of a product or service.

Specialization

The term **specialization** describes jobs that have a very narrow scope. Examples range from assembly lines to medical specialties. College professors often specialize in teaching certain courses, some auto mechanics specialize in transmission repair, and some bakers specialize in wedding cakes. The main rationale for specialization is the ability to concentrate one's efforts and thereby become proficient at that type of work.

Sometimes the amount of knowledge or training required of a specialist and the complexity of the work suggest that individuals who choose such work are very happy with their jobs. This seems to be especially true in the "professions" (e.g., doctors, lawyers, professors). At the other end of the scale are assembly-line workers, who are also specialists, although much less glamorous. The advantage of these highly specialized jobs is that they yield high productivity and relatively low unit costs, and they are largely responsible for the high standard of living that exists today in industrialized nations.

Unfortunately, many of the lower-level jobs can be described as monotonous or downright boring, and are the source of much of the dissatisfaction among many industrial workers. While some workers undoubtedly prefer a job with limited requirements and responsibility for making decisions, others are not capable of handling jobs with greater scopes. Nonetheless, many workers are frustrated, and this manifests itself in turnover and absenteeism. In the automotive industry, for example, absenteeism runs as high as 20 percent. Workers may also take out their frustrations through disruptive tactics such as deliberate slowdowns.

The seriousness of these problems caused job designers and others to seek ways of alleviating them. Some of those approaches are discussed in the following sections. Before we turn to them, note that the advantages and disadvantages of specialization are summarized in Table 7.1.



Correct positioning of equipment and tools can help reduce fatigue and increase employee productivity.

Advantages

For management:

- Simplifies training
- High productivity
- Low wage costs

For employees:

- Low education and skill requirements
- Minimum responsibilities
- Little mental effort needed

Disadvantages

For management:

- Difficult to motivate quality
- Worker dissatisfaction, possibly resulting in absenteeism, high turnover, disruptive tactics, poor attention to quality

For employees:

- Monotonous work
- Limited opportunities for advancement
- Little control over work
- Little opportunity for self-fulfillment

Behavioral Approaches to Job Design

In an effort to make jobs more interesting and meaningful, job designers frequently consider job enlargement, job rotation, job enrichment, and increased use of mechanization.

Job enlargement means giving a worker a larger portion of the total task. This constitutes *horizontal loading*—the additional work is on the same level of skill and responsibility as the original job. The goal is to make the job more interesting by increasing the variety of skills required and by providing the worker with a more recognizable contribution to the overall output. For example, a production worker's job might be expanded so that he or she is responsible for a *sequence* of activities instead of only one activity.

Job rotation means having workers periodically exchange jobs. This allows workers to broaden their learning experience and enables them to fill in for others in the event of sickness or absenteeism.

Job enrichment involves an increase in the level of responsibility for planning and coordination tasks. It is sometimes referred to as *vertical loading*. An example of this is to have stock clerks in supermarkets handle the reordering of goods, thus increasing their responsibilities. The job enrichment approach focuses on the motivating potential of worker satisfaction.

Job enlargement and job enrichment are also used in *lean operations* (covered in Chapter 14), where workers are cross-trained to be able to perform a wider variety of tasks and given more authority to manage their jobs.

The importance of these approaches to job design is that they have the potential to increase the motivational power of jobs by increasing worker satisfaction through improvement in the *quality of work life*.

Motivation

Motivation is a key factor in many aspects of work life. Not only can it influence quality and productivity, it also contributes to the work environment. People work for a variety of reasons in addition to compensation. Other reasons include socialization, self-actualization, status, the physiological aspects of work, and a sense of purpose and accomplishment. Awareness of these factors can help management to develop a motivational framework that encourages workers to respond in a positive manner to the goals of the organization. A detailed discussion of motivation is beyond the scope of this book, but its importance to work design should be obvious.

Another factor that influences motivation, productivity, and employee–management relations is *trust*. In an ideal work environment, there is a high level of trust between workers and managers. When managers trust employees, there is a greater tendency to give employees added responsibilities. When employees trust management, they are more likely to respond positively. Conversely, when they do not trust management, they are more likely to respond in less desirable ways.

Teams

The efforts of business organizations to become more productive, competitive, and customer-oriented have caused them to rethink how work is accomplished. Significant changes in the structure of some work environments have been the increasing use of teams and the way workers are paid, particularly in lean production systems.

TABLE 7.1

Major advantages and disadvantages of specialization in business

LO7.4 Describe behavioral approaches to job design.

Job enlargement Giving a worker a larger portion of the total task, by horizontal loading.

Job rotation Workers periodically exchange jobs.

Job enrichment Increasing responsibility for planning and coordination tasks, by vertical loading.

In the past, nonroutine job assignments, such as dealing with customer complaints or improving a process, were typically given to one individual or to several individuals who reported to the same manager. More recently, nonroutine assignments are being given to teams who develop and implement solutions to problems.

There are a number of different forms of teams. One is a short-term team formed to collaborate on a topic such as quality improvement, product or service design, or solving a problem. Team members may be drawn from the same functional area or from several functional areas, depending on the scope of the problem. Other teams are more long term. One form of long-term team that is increasingly being used, especially in lean production settings, is the *self-directed team*.

Self-directed teams Groups empowered to make certain changes in their work processes.

Self-directed teams, sometimes referred to as *self-managed teams*, are designed to achieve a higher level of teamwork and employee involvement. Although such teams are not given absolute authority to make all decisions, they are typically empowered to make changes in the work processes under their control. The underlying concept is that the workers, who are close to the process and have the best knowledge of it, are better suited than management to make the most effective changes to improve the process. Moreover, because they have a vested interest and personal involvement in the changes, they tend to work harder to ensure that the desired results are achieved than they would if management had implemented the changes. For these teams to function properly, team members must be trained in quality, process improvement, and teamwork. Self-directed teams have a number of benefits. One is that fewer managers are necessary; very often one manager can handle several teams. Also, self-directed teams can provide improved responsiveness to problems, they have a personal stake in making the process work, and they require less time to implement improvements.

Generally, the benefits of teams include higher quality, higher productivity, and greater worker satisfaction. Moreover, higher levels of employee satisfaction can lead to less turnover and absenteeism, resulting in lower costs to train new workers and less need to fill in for absent employees. This does not mean that organizations will have no difficulties in applying the team concept. Managers, particularly middle managers, often feel threatened as teams assume more of the traditional functions of managers.

Moreover, among the leading problems of teams are conflicts between team members, which can have a detrimental impact on the effectiveness of a team.

At the Michigan International Speedway pit stop, the Toyota team changes four tires, fills the gas tank, and does a maintenance check in under 15 seconds. This is done four to six times during a 400-mile NASCAR race.



John Harrelson/Getty Images for NASCAR

Expert Robert Bacal has a list of requirements for successful team building:¹

1. Clearly stated and commonly held vision and goals.
2. Talent and skills required to meet goals.
3. Clear understanding of team members' roles and functions.
4. Efficient and shared understanding of procedures and norms.
5. Effective and skilled interpersonal relations.
6. A system of reinforcement and celebration.
7. Clear understanding of the team's relationship to the greater organization.

Ergonomics

Ergonomics (or human factors) is the scientific discipline concerned with the understanding of interactions among humans and other elements of a system, and the profession that applies theory, principles, data, and methods to design in order to optimize human well-being and overall system performance. “Ergonomists contribute to the design and evaluation of tasks, jobs, products, environments and systems in order to make them compatible with the needs, abilities and limitations of people.”² In the work environment, ergonomics also helps to increase productivity by reducing worker discomfort and fatigue.

The International Ergonomics Association organizes ergonomics into three domains: physical (e.g., repetitive movements, layout, health, and safety); cognitive (mental workload, decision making, human–computer interaction, and work stress); and organizational (e.g., communication, teamwork, work design, and telework).³

Many examples of ergonomics applications can be found in operations management. In the early 1900s, Frederick Winslow Taylor, known as the father of scientific management, found that the amount of coal that workers could shovel could be increased substantially by reducing the size and weight of the shovels. Frank and Lillian Gilbreth expanded Taylor's work, developing a set of motion study principles intended to improve worker efficiency and reduce injury and fatigue. In the years since then, technological changes have broadened the scope of ergonomics, as hand–eye coordination and decision making became more important in the workplace. More recently, the increasing level of human–computer interfacing has again broadened the scope of the field of ergonomics, not only in job design, but also in electronics product design.

Poor posture can lead to fatigue, low productivity, and injuries to the back, neck, and arm. Good posture can help avoid or minimize these problems. Figure 7.1 illustrates good posture when using a computer.

Ergonomics Incorporation of human factors in the design of the workplace.

7.3 QUALITY OF WORK LIFE

People work for a variety of reasons. Generally, people work to earn a living. Also, they may be seeking self-realization, status, physical and mental stimulation, and socialization. Quality of work life affects not only workers' overall sense of well-being and contentment, but also worker productivity. Quality of work life has several key aspects. Getting along well with coworkers and having good managers can contribute greatly to the quality of work life. Leadership style is particularly important. Also important are working conditions and compensation, which are addressed here.

LO7.5 Discuss the impact of working conditions on job design.

¹Robert Bacal, “The Six Deadly Sins of Team-Building.” www.performance-appraisals.org

²The International Ergonomics Association (www.iea.cc).

³Ibid.

FIGURE 7.1 Components of a comfortable workstation

Working Conditions

Working conditions are an important aspect of job design. Physical factors such as temperature, humidity, ventilation, illumination, and noise can have a significant impact on worker performance in terms of productivity, quality of output, and accidents. In many instances, government regulations apply.

Temperature and Humidity. Although human beings can function under a fairly wide range of temperatures and humidity, work performance tends to be adversely affected if temperatures or humidities are outside a very narrow *comfort band*. That comfort band depends on how strenuous the work is; the more strenuous the work, the lower the comfort range.

Ventilation. Unpleasant and noxious odors can be distracting and dangerous to workers. Moreover, unless smoke and dust are periodically removed, the air can quickly become stale and annoying.

Illumination. The amount of illumination required depends largely on the type of work being performed; the more detailed the work, the higher the level of illumination needed for adequate performance. Other important considerations are the amount of glare and contrast.

From a safety standpoint, good lighting in halls, stairways, and other dangerous points is important.

Noise and Vibrations. Noise is unwanted sound. It is caused by both equipment and humans. Noise can be annoying or distracting, leading to errors and accidents. It also can damage or impair hearing if it is loud enough. Figure 7.2 illustrates loudness levels of some typical sounds.

Vibrations can be a factor in job design even without a noise component, so merely eliminating sound may not be sufficient in every case. Vibrations can come from tools, machines, vehicles, human activity, air-conditioning systems, pumps, and other sources. Corrective measures include padding, stabilizers, shock absorbers, cushioning, and rubber mountings.

dBA	Example	Home & Yard Appliances	Workshop & Construction
0	Healthy hearing threshold		
10	A pin dropping		
20	Rustling leaves		
30	Whisper		
40	Babbling brook	Computer	
50	Light traffic	Refrigerator	
60	Conversational speech	Air Conditioner	
70	Shower	Dishwasher	
75	Toilet flushing	Vacuum Cleaner	
80	Alarm clock	Garbage Disposal	
85	Passing diesel truck	Snow Blower	
90	Squeeze toy	Lawn Mower	Arc Welder
95	Inside subway car	Food Processor	Belt Sander
100	Motorcycle (riding)		Handheld Drill
105	Sporting event		Table Saw
110	Rock band		Jackhammer
115	Emergency vehicle siren		Riveter
120	Thunderclap		Oxygen Torch
125	Balloon popping		
130	Peak stadium crowd noise		
135	Air raid siren		
140	Jet engine at takeoff		
145	Firecracker		
150	Fighter jet launch		
155	Cap gun		
160	Shotgun		
165	.357 magnum revolver		

FIGURE 7.2

Decibel values of typical sounds (db)

Source: From Benjamin W. Niebel, *Motion and Time Study*, 8th ed. Copyright © 1988 Richard D. Irwin, Inc. Used by permission of McGraw-Hill Education, Inc., p. 248.

Work Time and Work Breaks. Reasonable (and sometimes flexible) work hours can provide a sense of freedom and control over one's work. This is useful in situations where the emphasis is on completing work on a timely basis and meeting performance objectives rather than being "on duty" for a given time interval, as is the case for most retail and manufacturing operations.

Work breaks are also important. Long work intervals tend to generate boredom and fatigue. Productivity and quality can both deteriorate. Similarly, periodic vacation breaks can give workers something to look forward to, a change of pace, and a chance to recharge themselves.

Occupational Health Care. Good worker health contributes to productivity, minimizes health care costs, and enhances workers' sense of well-being. Many organizations have exercise and healthy-eating programs designed to improve or maintain employees' fitness and general health.

Safety. Worker safety is one of the most basic issues in job design. This area needs constant attention from management, employees, and designers. Workers cannot be effectively motivated if they feel they are in physical danger.

From an employer standpoint, accidents are undesirable because workers can be injured, they are expensive (insurance and compensation); they usually involve damage to equipment and/or products; they require hiring, training, and makeup work; and they generally interrupt work. From a worker standpoint, accidents that result in injury can lead to mental anguish, possible loss of earnings, and disruption of the work routine.

The two basic causes of accidents are worker *carelessness* and accident *hazards*. Under the heading of carelessness come unsafe acts. Examples include failing to use protective equipment, overriding safety controls (e.g., taping control buttons down), disregarding safety procedures, using tools and equipment improperly, and failing to use reasonable caution in danger zones. Unsafe conditions include unprotected pulleys, chains, material-handling

equipment, machinery, and so on. Also, poorly lit walkways, stairs, and loading docks constitute hazards. Toxic wastes, gases and vapors, and radiation hazards must be contained. Protection against hazards involves use of proper lighting, clearly marked danger zones, use of protective equipment (hardhats, goggles, earmuffs, gloves, heavy shoes and clothing), safety devices (machine guards, dual control switches that require an operator to use both hands), emergency equipment (emergency showers, fire extinguishers, fire escapes), and thorough instruction in safety procedures and use of regular and emergency equipment. Housekeeping (clean floors, open aisles, waste removal) is another important safety factor.

An effective program of safety and accident control requires the cooperation of both workers and management. Workers must be trained in proper procedures and attitudes, and they can contribute to a reduction in hazards by pointing out hazards to management. Management must enforce safety procedures and the use of safety equipment. If supervisors allow workers to ignore safety procedures or look the other way when they see violations, workers will be less likely to take proper precautions. Some firms use contests that compare departmental safety records. However, accidents cannot be completely eliminated, and a freak accident may seriously affect worker morale and might even contribute to additional accidents. Posters can be effective, particularly if they communicate in specific terms how to avoid accidents. For example, the admonition “Be careful” is not nearly as effective as “Wear hardhats,” “Walk, don’t run,” or “Hold on to rail.”

The enactment of the Occupational Safety and Health Act in 1970, and the creation of the Occupational Safety and Health Administration (**OSHA**), emphasized the importance of safety considerations in systems design. The law was intended to ensure that workers in all organizations have healthy and safe working conditions. It provides specific safety regulations with inspectors to see that they are adhered to. Inspections are carried out both at random and to investigate complaints of unsafe conditions. OSHA officials are empowered to issue warnings, impose fines, and even to invoke court-ordered shutdowns for unsafe conditions.

OSHA must be regarded as a major influence on operations management decisions in all areas relating to worker safety. OSHA has promoted the welfare and safety of workers in its role as a catalyst, spurring companies to make changes that they knew were needed but “hadn’t gotten around to making.”

Ethical Issues. Ethical issues affect operations through work methods, working conditions and employee safety, accurate record keeping, unbiased performance appraisals, fair compensation, and opportunities for advancement.

Compensation

Compensation is a significant issue for the design of work systems. It is important for organizations to develop suitable compensation plans for their employees. If wages are too low, organizations may find it difficult to attract and hold competent workers and managers. If wages are too high, the increased costs may result in lower profits, or may force the organization to increase its prices, which might adversely affect demand for the organization’s products or services.

Organizations use a variety of approaches to compensate employees, including *time-based systems*, *output-based systems*, and *knowledge-based systems*. **Time-based systems**, also known as *hourly* and *measured daywork* systems, compensate employees for the time the employee has worked during a pay period. Salaried workers also represent a form of time-based compensation. **Output-based (incentive) systems** compensate employees according to the amount of output they produce during a pay period, thereby tying pay directly to performance.

Time-based systems are more widely used than incentive systems, particularly for office, administrative, and managerial employees, but also for blue-collar workers. One reason for this is that computation of wages is straightforward and managers can readily estimate labor costs for a given employee level. Employees often prefer time-based systems because the pay is steady and they know how much compensation they will receive for each pay period. In addition, employees may resent the pressures of an output-based system.

Another reason for using time-based systems is that many jobs do not lend themselves to the use of incentives. In some cases, it may be difficult or impossible to measure output. For example, jobs that require creative or mental work cannot be easily measured on an output basis. Other jobs may include irregular activities or have so many different forms of output

OSHA Occupational Safety and Health Administration, created by the Occupational Safety and Health Act of 1970.

Time-based system Compensation based on time an employee has worked during a pay period.

Output-based (incentive) system Compensation based on amount of output an employee produced during a pay period.



Engin Korkmaz/123RF

People work for a variety of reasons besides compensation. The work environment at Google makes it an appealing place to work. Google provides employees with a number of perks, including massage rooms, a music room, cafeteria, arcade games, and other benefits. The office in Dublin is the technology hub in Europe.

that measuring output and determining pay are fairly complex. In the case of assembly lines, the use of *individual* incentives could disrupt the even flow of work; however, *group* incentives are sometimes used successfully in such cases. Finally, *quality* considerations may be as important as *quantity* considerations. In health care, for example, emphasis is generally placed on both the quality of patient care and the number of patients processed.

On the other hand, situations exist where incentives are desirable. Incentives reward workers for their output, presumably causing some workers to produce more than they might under a time-based system. The advantage is that certain (fixed) costs do not vary with increases in output, so the overall cost per unit decreases if output increases. Workers may prefer incentive systems because they see a relationship between their efforts and their pay: An incentive system presents an opportunity for them to earn more money.

On the negative side, incentive systems involve a considerable amount of paperwork, computation of wages is more difficult than under time-based systems, output has to be measured and standards set, cost-of-living increases are difficult to incorporate into incentive plans, and contingency arrangements for unavoidable delays have to be developed.

Table 7.2 lists the main advantages and disadvantages of time-based and output-based plans.

In order to obtain maximum benefit from an incentive plan, the plan should be accurate, easy to understand and apply, and be fair and consistent. In addition, there should be an obvious relationship between effort and reward, and no limit on earnings.

Incentive systems may focus on the output of each individual or a group.

Individual Incentive Plans. Individual incentive plans take a variety of forms. The simplest plan is *straight piecework*. Under this plan, a worker's pay is a direct linear function of his or her output. In the past, piecework plans were fairly popular. Now minimum wage legislation makes them somewhat impractical. Even so, many of the plans currently in use represent variations of the straight piecework plan. They typically incorporate a base rate that serves as a floor: Workers are guaranteed that amount as a minimum, regardless of output. The base rate is tied to an output standard; a worker who produces less than the standard will be paid at the base rate. This protects workers from pay loss due to delays, breakdowns, and similar problems. In most cases, incentives are paid for output above standard, and the pay is referred to as a *bonus*.

Group Incentive Plans. A variety of group incentive plans, which stress sharing of productivity gains with employees, are in use. Some focus exclusively on output, while others reward employees for output and for reductions in material and other costs.

TABLE 7.2

Comparison of time-based and output-based pay systems

LO7.6 Compare the advantages and disadvantages of time-based and output-based pay systems.

	Management	Worker
TIME-BASED		
Advantages	<ul style="list-style-type: none"> • Stable labor costs • Easy to administer • Simple to compute pay • Stable output 	<ul style="list-style-type: none"> • Stable pay • Less pressure to produce than under output system
Disadvantages	<ul style="list-style-type: none"> • No incentive for workers to increase output 	<ul style="list-style-type: none"> • Extra efforts not rewarded
OUTPUT-BASED		
Advantages	<ul style="list-style-type: none"> • Lower cost per unit • Greater output 	<ul style="list-style-type: none"> • Pay related to efforts • Opportunity to earn more
Disadvantages	<ul style="list-style-type: none"> • Wage computation more difficult • Need to measure output • Quality may suffer • Difficult to incorporate wage increases • Increased problems with scheduling 	<ul style="list-style-type: none"> • Pay fluctuates • Workers may be penalized because of factors beyond their control (e.g., machine breakdown)

One form of group incentive is the *team approach*, which many companies are now using for problem solving and continuous improvement. The emphasis is on *team*, not *individual*, performance.

Knowledge-Based Pay Systems. As companies shift toward lean production, a number of changes have had a direct impact on the work environment. One is that many of the buffers that previously existed are gone. Another is that fewer managers are present. Still another is increased emphasis on quality, productivity, and flexibility. Consequently, workers who can perform a variety of tasks are particularly valuable. Organizations are increasingly recognizing this, and they are setting up pay systems to reward workers who undergo training that increases their skill levels. This is sometimes referred to as **knowledge-based pay**. It is a portion of a worker’s pay that is based on the knowledge and skill that the worker possesses. Knowledge-based pay has three dimensions: *Horizontal skills* reflect the variety of tasks the worker is capable of performing; *vertical skills* reflect managerial tasks the worker is capable of; and *depth skills* reflect quality and productivity results.

Knowledge-based pay Pay system used by organizations to reward workers who undergo training that increases their skills.

Management Compensation. Many organizations that traditionally rewarded managers and senior executives on the basis of *output* are now seriously reconsidering that approach. With the new emphasis on customer service and quality, reward systems are being restructured to reflect new dimensions of performance. In addition, executive pay in many companies is being more closely tied to the success of the company or division that the executive is responsible for. Even so, there have been news reports of companies increasing the compensation of top executives even as workers were being laid off and the company was losing large amounts of money!

Recent Trends. Many organizations are moving toward compensation systems that emphasize flexibility and performance objectives, with variable pay based on performance. Some are using profit-sharing plans, or bonuses based on achieving profit or cost goals. In addition, the increasing cost of employee health benefits is causing organizations to rethink their overall compensation packages. Some are placing more emphasis on quality of work life. An ideal compensation package is one that balances motivation, profitability, and retention of good employees.

LO7.7 Explain the purpose of methods analysis and describe how methods studies are performed.

7.4 METHODS ANALYSIS

Methods analysis focuses on how a job is done. Job design often begins with an analysis of the overall operation. It then moves from general to specific details of the job, concentrating on arrangement of the workplace and movements of materials and/or workers. Methods analysis can also be a good source of productivity improvements.

Methods analysis Analyzing how a job is done.

BY LISA SPENCER

Frederick Winslow Taylor, well known for his innovative ways of improving worker efficiency, studied the shoveling process at the Bethlehem Steel Company. He noticed that workers used the same “one-size-fits-all” shovels, regardless of how heavy or light the load was. Taylor determined the optimal weight of a loaded shovel, and developed different size shovels for different substances. In doing so, he nearly quadrupled what a worker could shovel in a day (“Frederick Winslow Taylor,” 2015).

Today, UPS implements Taylor’s ideas to maximize the efficiency of the individual worker, as well as the system overall. Rules and policies for worker movement, package loading, and delivery routes drive operations to increase productivity and decrease costs. Workers are taught to walk 2.5 paces per second. Keys have given way to proximity fobs attached to belt loops to get drivers into their vehicles more quickly, saving seconds on each delivery. Entering one less keystroke per driver per day on a handheld data device saves UPS \$100,000 per year, and yes, UPS really does track that! (Hagan, 2014).

The brown “package car,” UPS-speak for delivery truck, may look the same on the outside as it used to. However, technology and big data are changing work that was once primarily manual to a system where nearly every movement can be tracked and monitored. On-board computers gather data all day long, and over 200 sensors on each vehicle can tell if a driver is wearing a seatbelt, opening or closing a door, or using the brakes. Worker safety has increased, because seatbelts are now worn nearly 100 percent of the time. Sensors reveal when the vehicle is started and how fast it is going. They know if the bulkhead door is open, which street the vehicle is driving on, and the percent of time the vehicle is idling as opposed to being in motion (Stashik, 2014).

Sensors can detect when a driver is backing up, as well as how fast and how far. UPS wants drivers to avoid that practice because it can lead to accidents, and the company tells its workers if they are doing it too much. Using technology and data, UPS increased a typical driver’s day from 90 deliveries to 120 (Goldstein, 2014) while decreasing fuel usage by 8.5 million gallons a year due to better route optimization programs. UPS even uses diagnostic data for preventive maintenance to reduce the downtime that came, for instance, when hundreds of drivers were delayed on Monday mornings due to dead batteries. With telematics now tracking battery conditions, the company knows when it’s time to charge or change batteries before there is a problem. Randy Stashik, president of Engineering at UPS, explains, “We’ve evolved from a trucking company with technology to a technology company with trucks” (Stashik, 2014).

Based on:

“Frederick Winslow Taylor, the Patron Saint of the Shovel.” *Mental Floss Magazine*, April 27, 2015. <http://mentalfloss.com/article/63341/frederick-winslow-taylor-patron-saint-shovel>

Jacob Goldstein, “To Increase Productivity, UPS Monitors Drivers’ Every Move.” NPR, April 17, 2014. <https://www.npr.org/sections/money/2014/04/17/303770907/to-increase-productivity-ups-monitors-drivers-every-move>

Alex Hagan, “Frederick Taylor Has Been Reincarnated and Works for UPS Now.” May 5, 2014. <http://www.kienco.com.au/blog/workforce-analytics-and-neotaylorism>

Randy Stashick, “Big Data Delivers Big Results at UPS.” Production and Operations Management Society Conference, May 11, 2014. <https://pressroom.ups.com/pressroom/ContentDetailsViewer.page?ConceptType=Speeches&id=1426415450350-355>

The need for methods analysis can come from a number of different sources: Changes in tools and equipment, changes in product design or introduction of new products, changes in materials or procedures, government regulations or contractual agreements, and incidents such as accidents and quality problems.

Methods analysis is done for both existing jobs and new jobs. For a new job, it is needed to establish a method. For an existing job, the procedure usually is to have the analyst observe the job as it is currently being performed and then devise improvements. For a new job, the analyst must rely on a job description and an ability to visualize the operation.

The basic procedure in methods analysis is as follows:

1. Identify the operation to be studied, and gather all pertinent facts about tools, equipment, materials, and so on.
2. For existing jobs, discuss the job with the operator and supervisor to get their input.
3. Study and document the present method of an existing job using process charts. For new jobs, develop charts based on information about the activities involved.
4. Analyze the job.
5. Propose new methods.
6. Install the new methods.
7. Follow up implementation to assure that improvements have been achieved.

Selecting an Operation to Study. Sometimes a foreman or supervisor will request that a certain operation be studied. At other times, methods analysis will be part of an overall program to increase productivity and reduce costs. Some general guidelines for selecting a job to study are to consider jobs that:

- Have a high labor content
- Are done frequently
- Are unsafe, tiring, unpleasant, and/or noisy
- Are designated as problems (e.g., quality problems, processing bottlenecks)

Documenting the Current Method. Use charts, graphs, and verbal descriptions of the way the job is now being performed. This will provide a clear understanding of the job and serve as a basis of comparison against which revisions can be judged.

Analyzing the Job and Proposing New Methods. Job analysis requires careful thought about the what, why, when, where, and who of the job. Often, simply going through these questions will clarify the review process by encouraging the analyst to take a devil's advocate attitude toward both present and proposed methods.

Analyzing and improving methods is facilitated by the use of various charts such as *flow process charts* and *worker-machine charts*.

Flow process chart Chart used to examine the overall sequence of an operation by focusing on movements of the operator or flow of materials.

Flow process charts are used to review and critically examine the overall sequence of an operation by focusing on the movements of the operator or the flow of materials. These charts are helpful in identifying nonproductive parts of the process (e.g., delays, temporary storages, distances traveled). Figure 7.3 describes the symbols used in constructing a flow process chart, and Figure 7.4 illustrates a flow process chart.

The uses for flow process charts include studying the flow of material through a department, studying the sequence that documents or forms take, analyzing the movement and care of surgical patients, studying the layout of department and grocery stores, and handling mail.

Experienced analysts usually develop a checklist of questions they ask themselves to generate ideas for improvements. The following are some representative questions:

- Why is there a delay or storage at this point?
- How can travel distances be shortened or avoided?
- Can materials handling be reduced?



Courtesy of Peak Ergonomics

The most common ergonomic risk factors are awkward postures; excessive force for lifting, pushing, pulling, and gripping; and repetition involving the same group of muscles. On the left, the worker was using a pistol grip driver in a vertical application which was placing her into a poor shoulder posture. She was experiencing increasing pain in her right shoulder. On the right, by modifying the tools being used, the worker is now into a good shoulder posture.











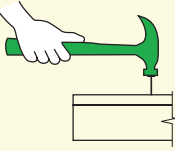
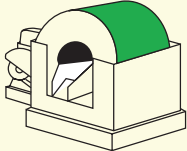

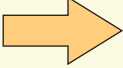
<p>Operation</p>  <p>A large circle indicates an operation such as</p>	 <p>Drive nail</p>	 <p>Mix</p>	 <p>Computer/word processing</p>
<p>Transportation</p>  <p>An arrow indicates a transportation, such as</p>	 <p>Move material by cart</p>	 <p>Move material by conveyor</p>	 <p>Move material by carrying (messenger)</p>
<p>Storage</p>  <p>A triangle indicates a storage, such as</p>	 <p>Raw material in bulk storage</p>	 <p>Finished stock stacked on pallets</p>	 <p>Protective filing of documents</p>
<p>Delay</p>  <p>A large Capital D indicates a delay, such as</p>	 <p>Wait for elevator</p>	 <p>Material in truck or on floor at bench waiting to be processed</p>	 <p>Papers waiting to be filed</p>
<p>Inspection</p>  <p>A square indicates an inspection, such as</p>	 <p>Examine material for quality or quantity</p>	 <p>Read steam gauge on boiler</p>	 <p>Examine printed form for information</p>

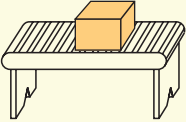
FIGURE 7.3
Process chart symbols

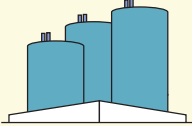
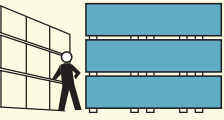
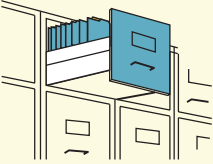
Source: Adapted from Benjamin W. Niebel, *Motion and Time Study*, 8th ed. Copyright © 1988 Richard D. Irwin, Inc. Used by permission of McGraw-Hill Education, Inc., p. 35.

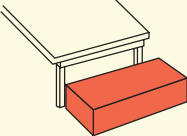
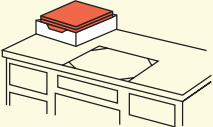
- Would a rearrangement of the workplace result in greater efficiency?
- Can similar activities be grouped?
- Would the use of additional or improved equipment be helpful?
- Does the worker have any ideas for improvements?

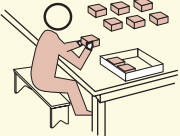
A **worker-machine chart** is helpful in visualizing the portions of a work cycle during which an operator and equipment are busy or idle. The analyst can easily see when the operator and machine are working independently and when their work overlaps or is interdependent. One use of this type of chart is to determine how many machines or how much equipment the operator can manage. Figure 7.5 presents an example of a worker-machine chart, where the “worker” is actually a customer weighing a purchase in the bulk-foods section of a supermarket. Among other things, the chart highlights worker and machine utilization.

Worker-machine chart Chart used to determine portions of a work cycle during which an operator and equipment are busy or idle.

FIGURE 7.4
Format of a flow process chart

Source: Elias M. Awad, *Systems Analysis and Design*, 4th ed. Copyright © 1985 by Richard D. Irwin, Inc. Used by permission of McGraw-Hill Education, Inc., p. 113.

FLOW PROCESS CHART	ANALYST	PAGE	Operation	Movement	Inspection	Delay	Storage
Job Requisition of petty cash	D. Kolb	1 of 2					
Details of method							
Requisition made out by department head			●	→	□	D	▽
Put in "pick-up" basket			○	→	□	D	▽
To accounting department			○	→	□	D	▽
Account and signature verified			○	→	□	D	▽
Amount approved by treasurer			●	→	□	D	▽
Amount counted by cashier			●	→	□	D	▽
Amount recorded by bookkeeper			●	→	□	D	▽
Petty cash sealed in envelope			●	→	□	D	▽
Petty cash carried to department			○	→	□	D	▽
Petty cash checked against requisition			○	→	□	D	▽
Receipt signed			●	→	□	D	▽
Petty cash stored in safety box			○	→	□	D	▽
			○	→	□	D	▽
			○	→	□	D	▽
			○	→	□	D	▽
			○	→	□	D	▽

FIGURE 7.5
Worker-machine chart

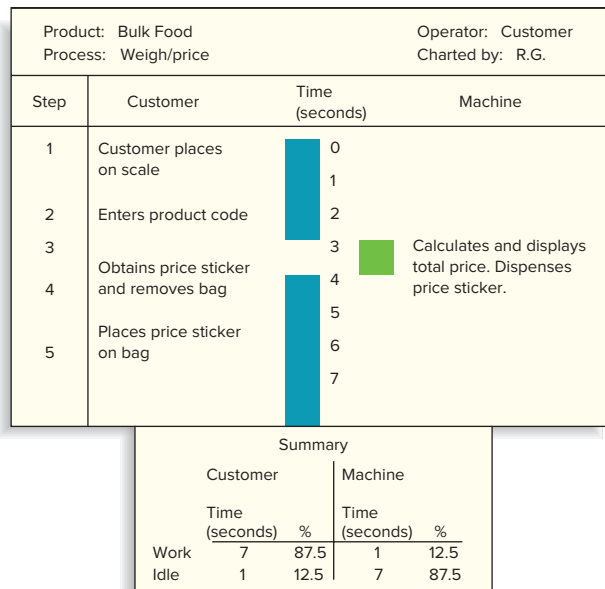

Installing the Improved Method. Successful implementation of proposed method changes requires convincing management of the desirability of the new method and obtaining the cooperation of workers. If workers have been consulted throughout the process and have made suggestions that are incorporated in the proposed changes, this part of the task will be considerably easier than if the analyst has assumed sole responsibility for the development of the proposal.

If the proposed method constitutes a major change from the way the job has been performed in the past, workers may have to undergo a certain amount of retraining, and full implementation may take some time to achieve.

The Follow-Up. In order to ensure that changes have been made and that the proposed method is functioning as expected, the analyst should review the operation after a reasonable period and consult again with the operator.

7.5 MOTION STUDY

Motion study is the systematic study of the human motions used to perform an operation. The purpose is to eliminate unnecessary motions and to identify the best sequence of motions for maximum efficiency. Hence, motion study can be an important avenue for productivity improvements. Present practice evolved from the work of Frank Gilbreth, who originated the concepts in the bricklaying trade in the early 20th century. Through the use of motion study techniques, Gilbreth is generally credited with increasing the average number of bricks laid per hour by a factor of 3, even though he was not a bricklayer by trade. When you stop to realize that bricklaying had been carried on for centuries, Gilbreth's accomplishment is even more remarkable.

There are a number of different techniques that motion study analysts can use to develop efficient procedures. The most-used techniques are the following:

- Motion study principles
- Analysis of therbligs
- Micromotion study
- Charts

Gilbreth's work laid the foundation for the development of **motion study principles**, which are guidelines for designing motion-efficient work procedures. The guidelines are divided into three categories: principles for use of the body, principles for arrangement of the workplace, and principles for the design of tools and equipment. Table 7.3 lists some examples of the principles.

In developing work methods that are motion efficient, the analyst tries to:

- Eliminate unnecessary motions
- Combine activities
- Reduce fatigue
- Improve the arrangement of the workplace
- Improve the design of tools and equipment

Therbligs are basic elemental motions. The term *therblig* is Gilbreth spelled backward (except for the *th*). The approach is to break jobs down into basic elements and base improvements on an analysis of these basic elements by eliminating, combining, or rearranging them.

- The use of the human body. Examples:
 - Both hands should begin and end their basic divisions of accomplishment simultaneously and should not be idle at the same instant, except during rest periods.
 - The motions made by the hands should be made symmetrically.
 - Continuous curved motions are preferable to straight-line motions involving sudden and sharp changes in direction.
- The arrangement and conditions of the workplace. Examples:
 - Fixed locations for all tools and material should be located to permit the best sequence and to eliminate or reduce the therbligs' search and select.
 - Gravity bins and drop delivery should reduce reach and move times; wherever possible, ejectors should remove finished parts automatically.
- The design of tools and equipment. Examples:
 - All levers, handles, wheels, and other control devices should be readily accessible to the operator and be designed to give the best possible mechanical advantage and to utilize the strongest available muscle group.
 - Parts should be held in position by fixtures.

Motion study Systematic study of the human motions used to perform an operation.

Motion study principles Guidelines for designing motion-efficient work procedures.

LO7.8 Describe four commonly used techniques for motion study.

Therbligs Basic elemental motions that make up a job.

TABLE 7.3
Motion study principles

Source: Adapted from Benjamin W. Niebel, *Motion and Time Study*, 8th ed. Copyright © 1988 Richard D. Irwin, Inc. pp. 206–207.

Although a complete description of therbligs is outside the scope of this text, a list of some common ones will illustrate the nature of these basic elemental motions:

Search implies hunting for an item with the hands and/or the eyes.

Select means to choose from a group of objects.

Grasp means to take hold of an object.

Hold refers to retention of an object after it has been grasped.

Transport load means movement of an object after hold.

Release load means to deposit the object.

Some other therbligs are *inspect, position, plan, rest, and delay*.

Describing a job using therbligs often takes a substantial amount of work. However, for short, repetitive jobs, therbligs analysis may be justified.

Frank Gilbreth and his wife, Lillian, an industrial psychologist, were also responsible for introducing motion pictures for studying motions, called **micromotion study**. This approach is applied not only in industry but also in many other areas of human endeavor, such as sports and health care. Use of the camera and slow-motion replay enables analysts to study motions that would otherwise be too rapid to see. In addition, the resulting films provide a permanent record that can be referred to, not only for training workers and analysts but also for settling job disputes involving work methods.

The cost of micromotion study limits its use to repetitive activities, where even minor improvements can yield substantial savings, owing to the number of times an operation is repeated, or where other considerations justify its use (e.g., surgical procedures).

Motion study analysts often use charts as tools for analyzing and recording motion studies. Activity charts and process charts, such as those described earlier, can be quite helpful. In addition, analysts may use a *simo chart* (see Figure 7.6) to study simultaneous motions of the hands. These charts are invaluable in studying operations such as data entry, sewing, surgical and dental procedures, and certain assembly operations.

Micromotion study Use of motion pictures and slow motion to study motions that otherwise would be too rapid to analyze.

7.6 WORK MEASUREMENT

LO7.9 Define a standard time.

Work measurement Determining how long it should take to do a job.

Standard time The time it should take a fully trained and qualified worker to complete a specific task, working at an efficient yet sustainable pace, using specific methods, tools and equipment, raw materials, and workplace arrangement.

Job design determines the *content* of a job, and methods analysis determines *how* a job is to be performed. **Work measurement** is concerned with determining the *length of time* it should take to complete the job. Job times are vital inputs for capacity planning, workforce planning, estimating labor costs, scheduling, budgeting, and designing incentive systems. Moreover, from the workers' standpoint, time standards reflect the amount of time it should take to do a given job working under typical conditions. The standards include expected activity time plus allowances for probable delays.

A **standard time** is the amount of time it should take a qualified worker to complete a specified task, working at a sustainable rate, using given methods, tools and equipment, raw material inputs, and workplace arrangement. Whenever a time standard is developed for a job, it is essential to provide a complete description of the parameters of the job because the actual time to do the job is sensitive to all of these factors; changes in any one of the factors can materially affect time requirements. For instance, changes in product design or changes in job performance brought about by a methods study should trigger a new time study to update the standard time. As a practical matter, though, minor changes are occasionally made that do not justify the expense of restudying the job. Consequently, the standards for many jobs may be slightly inaccurate. Periodic time studies may be used to update the standards.

Organizations develop time standards in a number of different ways. Although some small manufacturers and service organizations rely on subjective estimates of job times, the most commonly used methods of work measurement are (1) stopwatch time study, (2) historical times, (3) predetermined data, and (4) work sampling. The following pages describe each of these techniques in some detail.

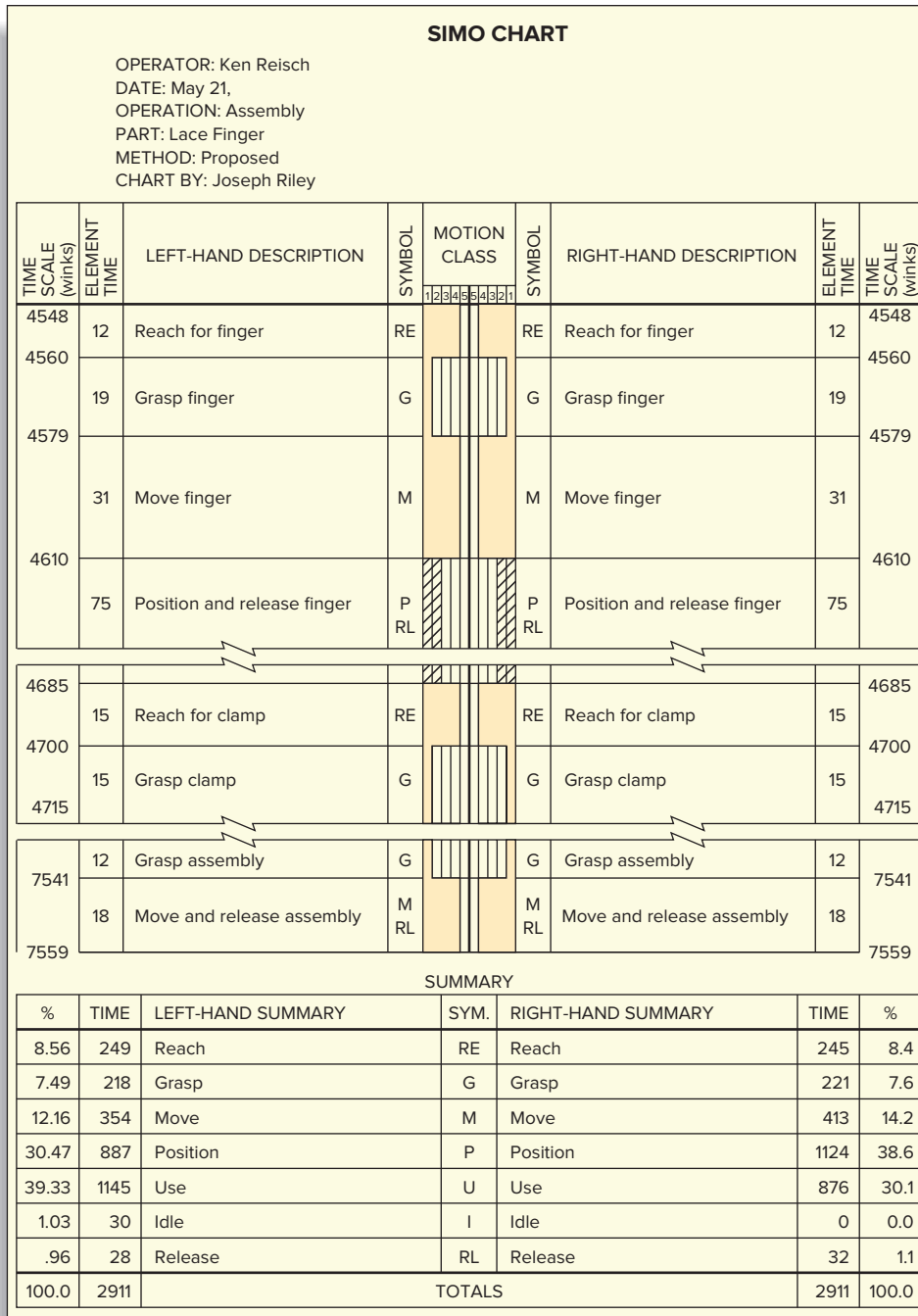

FIGURE 7.6
A simultaneous motion chart

Source: From Benjamin W. Niebel, *Motion and Time Study*, 8th ed. Copyright © 1988 Richard D. Irwin, Inc. Used by permission of McGraw-Hill Education, Inc., p. 229.

Stopwatch Time Study

Stopwatch time study was first introduced over a hundred years ago by Frederick Winslow Taylor to set times for manufacturing and construction activities. It was met with much resistance from workers, who felt they were being taken advantage of. Nonetheless, over time, this measurement tool gained acceptance, and it is now a common practice to conduct time studies on a wide range of activities in distribution and warehousing, janitorial services, waste management, call centers, hospitals, data processing, retail operations, sales, and service and repair operations. It is especially appropriate for short, repetitive tasks.

LO7.10 Describe and compare time study methods and perform calculations.

Stopwatch time study Development of a time standard based on observations of one worker taken over a number of cycles.

Stopwatch time study is used to develop a time standard based on observations of one worker taken over a number of cycles. That is then applied to the work of all others in the organization who perform the same task. The basic steps in a time study are the following:

1. Define the task to be studied, and inform the worker who will be studied.
2. Determine the number of cycles to observe.
3. Time the job and rate the worker's performance.
4. Compute the standard time.

The analyst who studies the job should be thoroughly familiar with it, because it is not unusual for workers to attempt to include extra motions during the study in hope of gaining a standard that allows more time per piece (i.e., the worker will be able to work at a slower pace and still meet the standard). Furthermore, the analyst will need to check that the job is being performed efficiently before setting the time standard.

In most instances, an analyst will break all but very short jobs down into basic elemental motions (e.g., reach, grasp) and obtain times for each element. There are several reasons for this: One is that some elements are not performed in every cycle, and the breakdown enables the analyst to get a better perspective on them. Another is that the worker's proficiency may not be the same for all elements of the job. A third reason is to build a file of elemental times that can be used to set times for other jobs. This use will be described later.

Workers sometimes feel uneasy about being studied and fear changes that might result. The analyst should make an attempt to discuss these things with the worker prior to studying an operation to allay such fears and to enlist the cooperation of the worker.

The number of cycles that must be timed is a function of three things: (1) the variability of observed times, (2) the desired accuracy, and (3) the desired level of confidence for the estimated job time. Very often, the desired accuracy is expressed as a percentage of the mean of the observed times. For example, the goal of a time study may be to achieve an estimate that is within 10 percent of the actual mean. The sample size needed to achieve that goal can be determined using this formula:

$$n = \left(\frac{zs}{a\bar{x}} \right)^2 \quad \text{Use this formula when desired accuracy is a percent.} \quad (7-1)$$

where

- z = Number of normal standard deviations needed for desired confidence
- s = Sample standard deviation
- a = Desired accuracy percentage
- \bar{x} = Sample mean

Typical values of z used in this computation are:⁴

Desired Confidence (%)	z Value
90	1.65
95	1.96
95.5	2.00
98	2.33
99	2.58

Of course, the value of z for any desired confidence can be obtained from the normal table in Appendix B, Table A.

⁴Theoretically, a t rather than a z value should be used because the population standard deviation is unknown. However, the use of z is simpler and provides reasonable results when the number of observations is 30 or more, as it generally is. In practice, z is used almost exclusively.

An alternate formula used when the desired accuracy, e , is stated as an *amount* (e.g., within one minute of the true mean) instead of a percentage is

$$n = \left(\frac{zs}{e}\right)^2 \quad \text{Use this formula when desired accuracy is a time.} \quad (7-2)$$

where

e = Maximum acceptable amount of time error

To make a preliminary estimate of sample size, it is typical to take a small number of observations (i.e., 10 to 20) and compute values of \bar{x} and s to use in the formula for n . Toward the end of the study, the analyst may want to recompute n using revised estimates of \bar{x} and s based on the increased data available.

Note: These formulas may or may not be used in practice, depending on the person doing the time study. Often, an experienced analyst will rely on his or her judgment in deciding on the number of cycles to time.

Determining Number of Observations Needed in a Time Study

A time study analyst wants to estimate the time required to perform a certain job. A preliminary study yielded a mean of 6.4 minutes and a standard deviation of 2.1 minutes. The desired confidence is 95 percent. How many observations will he need (including those already taken) if the desired maximum error is:

- ± 10 percent of the sample mean?
- One-half minute?

EXAMPLE 1

eXcel
mhhe.com/stevenson14e

- $s = 2.1$ minutes $z = 1.96$
 $\bar{x} = 6.4$ minutes $a = 10\%$

$$n = \left(\frac{zs}{a\bar{x}}\right)^2 = \left(\frac{1.96(2.1)}{.10(6.4)}\right)^2 = 41.36; \text{ round up to 42 observations}$$

- $e = .5$ minute $n = \left(\frac{zs}{e}\right)^2 = \left(\frac{1.96(2.1)}{.5}\right)^2 = 67.77; \text{ round up to 68 observations}$

SOLUTION

Note: When the value of n is noninteger, round up.

Development of a time standard involves computation of three times: the *observed time* (OT), the *normal time* (NT), and the *standard time* (ST).

Observed Time. The observed time is simply the average of the recorded times. Thus,

$$OT = \frac{\sum x_i}{n} \quad (7-3)$$

where

OT = Observed time

$\sum x_i$ = Sum of recorded times

n = Number of observations

Note: If a job element does not occur each cycle, its average time should be determined separately and that amount should be included in the observed time, OT.

Normal Time. The normal time is the observed time adjusted for worker performance. It is computed by multiplying the observed time by a *performance rating*. That is,

$$NT = OT \times PR \quad (7-4)$$

where

NT = Normal time
PR = Performance rating

This assumes that a single performance rating has been made for the entire job. If ratings are made on an element-by-element basis, the normal time is obtained by multiplying each element's average time by its performance rating and summing those values:

$$NT = \sum(\bar{x}_j \times PR_j) \quad (7-5)$$

where

\bar{x}_j = Average time for element j
PR $_j$ = Performance rating for element

The reason for including this adjustment factor is that the worker being observed may be working at a rate different from a "normal" rate, either to deliberately slow the pace or because his or her natural abilities differ from the norm. For this reason, the observer assigns a performance rating, to adjust the observed times to an "average" pace. A normal rating is 1.00. A performance rating of .9 indicates a pace that is 90 percent of normal, whereas a rating of 1.05 indicates a pace that is slightly faster than normal. For long jobs, each element may be rated; for short jobs, a single rating may be made for an entire cycle. Machine segments of a job are typically given a rating of 1.00.

When assessing performance, the analyst must compare the observed performance to his or her concept of normal. Obviously, there is room for debate about what constitutes normal performance, and performance ratings are sometimes the source of considerable conflict between labor and management. Although no one has been able to suggest a way around these subjective evaluations, sufficient training and periodic *recalibration* of analysts using training films can provide a high degree of consistency in the ratings of different analysts. To avoid any bias, a second analyst may be called in to also do performance ratings. In fact, union shops may require this.

Standard Time. The normal time does not take into account such factors as personal delays (worker fatigue, getting a drink of water or going to the restroom), unavoidable delays (machine adjustments and repairs, talking to a supervisor, waiting for materials), or breaks. The standard time for a job is the normal time multiplied by an *allowance factor* for these delays.

The standard time is

$$ST = NT \times AF \quad (7-6)$$

where

ST = Standard time
AF = Allowance factor

Allowances can be based on either job time or time worked (e.g., a workday). If allowances are based on *the job time*, the allowance factor is computed using the following formula:

$$AF_{\text{job}} = 1 + A, \text{ where } A = \text{Allowance percentage based on job time} \quad (7-7)$$

This is used when different jobs have different allowances. If allowances are based on a amount of the time worked (i.e., the *workday*), the appropriate formula is

$$AF_{\text{day}} = \frac{1}{1 - A} \text{ where } A = \text{Allowance percentage based on workday} \quad (7-8)$$

This is used when jobs are the same or similar and have the same allowance factors.

Computing Allowance Factors

EXAMPLE 2

Compute the allowance factor for these two cases:

- The allowance is 20 percent of *job* time.
- The allowance is 20 percent of *work* time.



mhhe.com/stevenson14e

SOLUTION

$$A = .20$$

- $AF = 1 + A = 1.20$, or 120%

$$AF = \frac{1}{1 - A} = \frac{1}{1 - .20} = 1.25, \text{ or } 125\%$$

Table 7.4 illustrates some typical allowances. In practice, allowances may be based on the judgment of the time study analyst, work sampling (described later in the chapter), or negotiations between labor and management.

Example 3 illustrates the time study process from observed times to the standard time.

Computing a Time Standard

EXAMPLE 3

A time study of an assembly operation yielded the following observed times for one element of the job, for which the analyst gave a performance rating of 1.13. Using an allowance of 20 percent of *job* time, determine the appropriate standard time for this operation.



mhhe.com/stevenson14e

<i>i</i> Observation	Time, <i>x</i> (minutes)	<i>i</i> Observation	Time, <i>x</i> (minutes)
1	1.12	6	1.18
2	1.15	7	1.14
3	1.16	8	1.14
4	1.12	9	1.19
5	1.15		Total 10.35

$$n = 9 \quad PR = 1.13 \quad A = .20$$

SOLUTION

- $OT = \frac{\sum x_i}{n} = \frac{10.35}{9} = 1.15$ minutes
- $NT = OT \times PR = 1.15(1.13) = 1.30$ minutes
- $ST = NT \times (1 + A) = 1.30(1.20) = 1.56$ minutes

Note: If an abnormally short time has been recorded, it typically would be assumed to be the result of observational error and thus discarded. If one of the observations in Example 3 had been .10, it would have been discarded. However, if an abnormally *long* time has been recorded, the analyst would want to investigate that observation to determine whether some irregularly occurring aspect of the task (e.g., retrieving a dropped tool or part) exists, which should legitimately be factored into the job time.

Despite the obvious benefits that can be derived from work measurement using time study, some limitations also must be mentioned. One limitation is the fact that only those jobs that can be observed can be studied. This precludes most managerial and creative jobs, because these involve mental as well as physical aspects. Also, the cost of the study rules out its use for irregular operations and infrequently occurring jobs. Finally, it disrupts the normal work routine, and workers resent it in many cases.

TABLE 7.4
Typical allowance percentages for working conditions

Source: From Benjamin W. Niebel, *Motion and Time Study*, 8th ed. Richard D. Irwin, Inc. p. 416. 1988.

	Percent		Percent
A. Constant allowances:		4. Bad light:	
1. Personal allowance	5	a. Slightly below recommended.	0
2. Basic fatigue allowances	4	b. Well below	2
B. Variable allowances:		c. Very inadequate	5
1. Standing allowance	2	5. Atmospheric conditions	
2. Abnormal position allowance:		(heat and humidity)—variable	0–10
a. Slightly awkward	0	6. Close attention:	
b. Awkward (bending	2	a. Fairly fine work	0
c. Very awkward (lying, stretching)	7	b. Fine or exacting	2
C. Use of force or muscular energy		c. Very fine or very exacting.	5
(lifting, pulling, or pushing):		7. Noise level:	
Weight lifted (in pounds):		a. Continuous	0
5	0	b. Intermittent—loud	2
10	1	c. Intermittent—very loud	5
15	2	d. High-pitched—loud	5
20	3	8. Mental strain:	
25	4	a. Fairly complex process	1
30	5	b. Complex or wide span of attention	4
35	7	c. Very complex.	8
40	9	9. Monotony:	
45	11	a. Low	0
50	13	b. Medium	1
60	17	c. High	4
70	22	10. Tediousness:	
		a. Rather tedious	0
		b. Tedious	2
		c. Very tedious	5

Standard Elemental Times

Standard elemental times
Time standards derived from a firm’s historical time data.

Standard elemental times are derived from a firm’s own historical time study data. Over the years, a time study department can accumulate a file of elemental times that are common to many jobs. After a while, many elemental times can be simply retrieved from the file, eliminating the need for analysts to go through a complete time study to obtain them.

The procedure for using standard elemental times consists of the following steps:

1. Analyze the job to identify the standard elements.
2. Check the file for elements that have historical times, and record them. Use time study to obtain others, if necessary.
3. Modify the file times if necessary (explained as follows).
4. Sum the elemental times to obtain the normal time, and factor in allowances to obtain the standard time.

In some cases, the file times may not pertain exactly to a specific task. For instance, standard elemental times might be on file for “move the tool 3 centimeters” and “move the tool 9 centimeters,” when the task in question involves a move of 6 centimeters. However, it is often possible to interpolate between values on file to obtain the desired time estimate.

One obvious advantage of this approach is the potential savings in cost and effort created by not having to conduct a complete time study for each job. A second advantage is that there is less disruption of work, again because the analyst does not have to time the worker. A third advantage is that performance ratings do not have to be done; they are generally *averaged* in the file times. The main disadvantage of this approach is that times

may not exist for enough standard elements to make it worthwhile, and the file times may be biased or inaccurate.

The method described in the following section is a variation of this approach, which helps avoid some of these problems.

Predetermined Time Standards

Predetermined time standards involve the use of published data on standard elemental times. A commonly used system is *methods-time measurement (MTM)*, which was developed by the Methods Engineering Council. The MTM tables are based on extensive research of basic elemental motions and times. To use this approach, the analyst must divide the job into its basic elements (reach, move, turn, disengage), measure the distances involved (if applicable), rate the difficulty of the element, and then refer to the appropriate table of data to obtain the time for that element. The standard time for the job is obtained by adding the times for all of the basic elements. One minute of work may cover quite a few basic elements; a typical job may involve several hundred or more of these basic elements. The analyst needs a considerable amount of skill to adequately describe the operation and develop realistic time estimates. Analysts generally take training or certification courses to develop the necessary skills to do this kind of work.

Among the advantages of predetermined time standards are the following:

- They are based on large numbers of workers under controlled conditions.
- The analyst is not required to rate performance in developing the standard.
- There is no disruption of the operation.
- Standards can be established even before a job is done.

Although proponents of predetermined standards claim that the approach provides much better accuracy than stopwatch studies, not everyone agrees with that claim. Some argue that many activity times are too specific to a given operation to be generalized from published data. Others argue that different analysts perceive elemental activity breakdowns in different ways, and that this adversely affects the development of times and produces varying time estimates among analysts. Still others claim that analysts differ on the degree of difficulty they assign a given task and thereby obtain different time standards.

Work Sampling

Work sampling is a technique for estimating the proportion of time that a worker or machine spends on various activities and in idle time.

Unlike time study, work sampling does not require timing an activity, nor does it even involve continuous observation of the activity. Instead, an observer makes brief observations of a worker or machine at random intervals and simply notes the nature of the activity. For example, a machine may be busy or idle; a secretary may be typing, filing, talking on the telephone, and so on; and a carpenter may be carrying supplies, taking measurements, cutting wood, and so on. The resulting data are *counts* of the number of times each category of activity or nonactivity was observed.

Although work sampling is occasionally used to set time standards, its two primary uses are in (1) ratio-delay studies, which concern the percentage of a worker's time that involves unavoidable delays or the proportion of time a machine is idle, and (2) analysis of nonrepetitive jobs. In a ratio-delay study, a hospital administrator, for example, might want to estimate the percentage of time that a certain piece of X-ray equipment is not in use. In a nonrepetitive job, such as secretarial work or maintenance, it can be important to establish the percentage of time an employee spends doing various tasks.

Nonrepetitive jobs typically involve a broader range of skills than repetitive jobs, and workers in these jobs are often paid on the basis of the highest skill involved. Therefore, it is important to determine the proportion of time spent on the high-skill level. For example, a secretary may do word processing, file, answer the telephone, and do other routine office work.

Predetermined time standards Published data based on extensive research to determine standard elemental times.

LO7.11 Describe work sampling and perform calculations.

Work sampling Technique for estimating the proportion of time that a worker or machine spends on various activities and in idle time.

If the secretary spends a high percentage of time filing instead of doing word processing, the compensation will be lower than for a secretary who spends a high percentage of time doing word processing. Work sampling can be used to verify those percentages and can therefore be an important tool in developing the job description. In addition, work sampling can be part of a program for validation of job content that is needed for “bona fide occupational qualifications”—that is, advertised jobs requiring the skills that are specified.

Work sampling estimates include some degree of error. Hence, it is important to treat work sampling estimates as *approximations* of the actual proportion of time devoted to a given activity. The goal of work sampling is to obtain an estimate that provides a specified confidence of not differing from the true value by more than a specified error. For example, a hospital administrator might request an estimate of X-ray idle time that will provide a 95 percent confidence of being within 4 percent of the actual percentage. Hence, work sampling is designed to produce a value, \hat{p} , which estimates the true proportion, p , within some allowable error, $e: \hat{p} \pm e$. The variability associated with sample estimates of p tends to be approximately normal for large sample sizes. The amount of maximum probable error is a function of both the sample size and the desired level of confidence.

For large samples, the maximum error percent e can be computed using the following formula:

$$e = z \sqrt{\frac{\hat{p}(1 - \hat{p})}{n}} \quad (7-9)$$

where

z = Number of standard deviations needed to achieve desired confidence

\hat{p} = Sample proportion (the number of occurrences divided by the sample size)

n = Sample size

In most instances, management will specify the desired confidence level and amount of allowable error, and the analyst will be required to determine a sample size sufficient to obtain these results. The appropriate value for n can be determined by solving Formula 7-9 for n , which yields

$$n = \left(\frac{z}{e}\right)^2 \hat{p}(1 - \hat{p}) \quad (7-10)$$

EXAMPLE 4

eXcel

mhhe.com/stevenson14e

Computing a Sample Size for Work Sampling

The manager of a small supermarket chain wants to estimate the proportion of time that stock clerks spend actually putting up stock, as opposed to other aspects of their job—such as assisting customers, bagging groceries, or doing other tasks. The manager wants a 98 percent confidence that the resulting estimate will be within 5 percent of the true value. What sample size should she use?

SOLUTION

$z = 2.33$, $e = .05$, \hat{p} is unknown

When no sample estimate of p is available, a preliminary estimate of sample size can be obtained using $\hat{p} = .50$. After 20 or so observations, a new estimate of \hat{p} can be obtained from those observations and a revised value of n computed using the new \hat{p} . It would be prudent to recompute the value of n at two or three points during the study to obtain a better indication of the necessary sample size. Thus, the initial estimate of n is

$$n = \left(\frac{2.33}{.05}\right)^2 .50(1 - .50) = 542.89, \text{ or } 543 \text{ observations}$$

Suppose that, in the first 20 observations, stock clerks were found to be putting up stock twice, making $\hat{p} = 2/20 = .10$. The revised estimate of n at that point would be

$$n = \left(\frac{2.33}{.05}\right)^2 .10(1 - .10) = 195.44, \text{ or } 196 \text{ observations}$$

Suppose a second check is made after a total of 100 observations, and $\hat{p} = .11$ at this point (including the initial 20 observations). Recomputing n yields

$$n = \left(\frac{2.33}{.05}\right)^2 .11(.89) = 212.60, \text{ or } 213 \text{ observations}$$

Note: As before, if the resulting value of n is noninteger, round *up*.

Perhaps the manager might make one more check to settle on a final value for n . If the computed value of n is less than the number of observations already taken, sampling would be terminated at that point.

Determining the sample size is only one part of work sampling. The overall procedure consists of the following steps:

1. Clearly identify the worker(s) or machine(s) to be studied.
2. Notify the workers and supervisors of the purpose of the study to avoid arousing suspicions.
3. Compute an initial estimate of sample size using a preliminary estimate of p , if available (e.g., from analyst experience or past data). Otherwise, use $\hat{p} = .50$.
4. Develop a random observation schedule.
5. Begin taking observations. Recompute the required sample size several times during the study.
6. Determine the estimated proportion of time spent on the specified activity.

Careful problem definition can prevent mistakes such as observing the wrong worker or wrong activity. It is also important to take observations randomly in order to get valid results.

Observations must be spread out over a period of time so that a true indication of variability is obtained. If observations are bunched too closely in time, the behaviors observed during that time may not genuinely reflect typical performance.

Determination of a random observation schedule involves the use of a **random number table** (see Table 7.5), which consists of *unordered sequences* of numbers (i.e., random). Use of these tables enables the analyst to incorporate randomness into the observation schedule. Numbers obtained from the table can be used to identify observation times for a study. Any size number (i.e., any number of digits read as one number) can be obtained from the table. The digits are in groups of four for convenience only. The basic idea is to obtain numbers from the table and to convert each one so it corresponds to an observation time. There are a number of ways to accomplish this. In the approach used here, we will obtain three sets of numbers from the table for each observation: The first set will correspond to the *day*, the second to the *hour*, and the third to the *minute* when the observation is to be made. The number of digits necessary for any set will relate to the number of days in the study, the number of hours per day, and minutes per hour. For instance, if the study covers 47 days, a two-digit number will be needed; if the activity is performed for eight hours per day, a one-digit number will be needed for hours. Of course, because each hour has 60 minutes, a two-digit number will be needed for minutes. Thus, we need a two-digit number for the day, a one-digit number for the hour, and a two-digit number for minutes. A study requiring observations over a

Random number table Table consisting of unordered sequences of numbers, used to determine random observation schedules.

TABLE 7.5

Portion of a random number table

	1	2	3	4	5	6
1	6912	7264	2801	8901	4627	8387
2	3491	1192	0575	7547	2093	4617
3	4715	2486	2776	2664	3856	0064
4	1632	1546	1950	1844	1123	1908
5	8510	7209	0938	2376	0120	4237
6	3950	1328	7343	6083	2108	2044
7	7871	7752	0521	8511	3956	3957
8	2716	1396	7354	0249	7728	8818
9	2935	8259	9912	3761	4028	9207
10	8533	9957	9585	1039	2159	2438
11	0508	1640	2768	4666	9530	3352
12	2951	0131	4359	3095	4421	3018

seven-day period in an office that works nine hours per day needs one-digit numbers for days, one-digit numbers for hours, and two-digit numbers for minutes.

Suppose that three observations will be made in the last case (i.e., seven days, nine hours, 60 minutes). We might begin by determining the days on which observations will be made, then the hours, and finally the minutes. Let's begin with the first row in the random number table and read across: The first number is 6, which indicates day 6. The second number is 9. Because it exceeds the number of days in the study, it is simply ignored. The third number is 1, indicating day 1, and the next is 2, indicating day 2. Hence, observations will be made on days 6, 1, and 2. Next, we determine the hours. Suppose we read the second row of column 1, again obtaining one-digit numbers. We find

3 (= 3rd hour), 4 (= 4th hour), 9 (= 9th hour)

Moving to the next row and reading two-digit numbers, we find

47 (= 47th minute), 15 (= 15th minute), 24 (= 24th minute)

Combining these results yields the following:

Day	Hour	Minute
6	3	47
1	4	15
2	9	24

This means that on day 6 of the study an observation is to be made during the 47th minute of the 3rd hour; on day 1, during the 15th minute of the 4th hour; and on day 2, during the 24th minute of the 9th hour. For simplicity, these times can be put in chronological order by day. Thus,

Day	Hour	Minute
1	4	15
2	9	24
6	3	47

A complete schedule of observations might appear as follows, after all numbers have been arranged in chronological order, assuming 10 observations per day for two days:

DAY 1				DAY 2			
Observation	Time	Busy (✓)	Idle (✓)	Observation	Time	Busy (✓)	Idle (✓)
1	8:15			1	8:04		
2	9:24			2	9:15		
3	9:02			3	9:24		
4	9:31			4	9:35		
5	9:48			5	10:12		
6	10:05			6	10:27		
7	10:20			7	10:38		
8	11:02			8	10:58		
9	1:13			9	11:50		
10	3:55			10	1:14		

The general procedure for using a random number table is to read the numbers in some sequence (across rows, down or up columns), discarding any that lack correspondence. It is important to vary the starting point from one study to the next to avoid taking observations at the same times, because workers will quickly learn the times that observations are made, and the random feature will be lost. One way to choose a starting point is to use the serial number on a dollar bill to select a starting point.

In sum, the procedure for identifying random times at which to make work sampling observations involves the following steps:

1. Determine the number of days in the study and the number of hours per day. This will indicate the required number of digits for days and hours.
2. Obtain the necessary number of sets for *days*, ignoring any sets that exceed the number of days.
3. Repeat step 2 for *hours*.
4. Repeat step 2 for *minutes*.
5. Link the days, hours, and minutes in the order they were obtained.
6. Place the observation times in chronological order.

Table 7.6 presents a comparison of work sampling and time study. It suggests that a work sampling approach to determining job times is less formal and less detailed, and best suited to nonrepetitive jobs.

7.7 OPERATIONS STRATEGY

It is important for management to make the design of work systems a key element of its operations strategy. Despite the major advances in computers and operations technology, people are still the heart of a business. They can make or break it, regardless of the technology used. Technology is important, of course, but technology alone is not enough.

The topics described in this chapter all have an impact on productivity. Although they lack the glamour of high tech, they are essential to the fundamentals of work design.

Workers can be a valuable source of insight and creativity because they actually perform the jobs and are closest to the problems that arise. All too often, managers overlook contributions and potential contributions of employees, sometimes from ignorance and sometimes from a false sense of pride. Union-management differences are also a factor. More and more, though, companies are attempting to develop a spirit of cooperation between employees and managers.

TABLE 7.6

Using work sampling instead of stopwatch time study

LO7.12 Compare stopwatch time study and work sampling.

Advantages

- Observations are spread out over a period of time, making results less susceptible to short-term fluctuations.
- There is little or no disruption of work.
- Workers are less resentful.
- Studies are less costly and less time-consuming, and the skill requirements of the analyst are much less.
- Studies can be interrupted without affecting the results.
- Many different studies can be conducted simultaneously.
- No timing device is required.
- It is well-suited for nonrepetitive tasks.

Disadvantages

- There is much less detail on the elements of a job.
- Workers may alter their work patterns when they spot the observer, thereby invalidating the results.
- In many cases, there is no record of the method used by the worker.
- Observers may fail to adhere to a random schedule of observations.
- It is not well-suited to short, repetitive tasks.
- Much time may be required to move from one workplace to another and back to satisfy the randomness requirement.

In the same vein, an increasing number of companies are focusing attention on improving the quality of work life and instilling pride and respect among workers. Many organizations are reaping surprising gains through worker *empowerment*, giving workers more say over their jobs.

The design of work systems involves quality of work life considerations as well as job design, methods analysis, and work measurement.

SUMMARY

Quality of work life includes relationships with managers and co-workers, working conditions, and compensation. Job design is concerned with job content and work methods. In the past, job design tended to emphasize efficiency. More recently, emphasis has expanded to include behavioral considerations and worker satisfaction. Current concerns about productivity have thrust job design into the limelight. However, the jobs usually associated with high productivity are often the same jobs that are the greatest source of worker dissatisfaction, creating somewhat of a paradox for job designers.

Analysts often use methods analysis and motion study techniques to develop the “efficiency” aspects of jobs, but these do not directly address behavioral aspects. Nonetheless, they are an important part of job design. Working conditions are also a notable aspect of job design, not only because of the behavioral and efficiency factors but also because of concern for the health and safety of workers.

Work measurement is concerned with specifying the length of time needed to complete a job. Such information is vital for personnel planning, cost estimating, budgeting, scheduling, and worker compensation. Commonly used approaches include stopwatch time study and predetermined times. A related technique is work sampling, which can also be used to obtain data on activity times. More commonly, work sampling is used to estimate the proportion of time a worker spends on a certain aspect of the job. Table 7.7 provides a summary of the formulas used in time studies and work sampling.

Organizations can choose from a variety of compensation plans. It is important to do so carefully, for compensation is key to both the worker and the organization, and, once adopted, it is usually difficult to substantially change a compensation plan.

KEY POINTS

1. Work design focuses on the core of operations.
2. Job design determines job content; methods analysis and motion study determine how a job is to be performed; and work measurement determines the time it should take to do a job.
3. The information provided by job design, methods analysis, motion study, and time standards is extremely valuable for process and productivity improvement.
4. Quality of work life can be a major factor in maintaining a productive workforce.

Time Study	Work Sampling
<p>A. Sample size</p> $n = \left(\frac{ZS}{a\bar{x}}\right)^2 \quad (7-1)$ <p>[Use for % accuracy.]</p> $n = \left(\frac{ZS}{e}\right)^2 \quad (7-2)$ <p>[Use for time accuracy.]</p> <p>B. Observed time</p> $OT = \frac{\sum X_i}{n} \quad (7-3)$ <p>C. Normal time</p> $NT = OT \times PR \quad (7-4)$ $NT = \sum (\bar{x}_j \times PR_j) \quad (7-5)$ <p>D. Standard time</p> $ST = NT \times AF \quad (7-6)$ <p>E. Allowance factor</p> $AF_{\text{job}} = 1 + A \quad (7-7)$ $AF_{\text{day}} = \frac{1}{1 - A} \quad (7-8)$	<p>A. Maximum error</p> $e = z \sqrt{\frac{\hat{p}(1 - \hat{p})}{n}} \quad (7-9)$ <p>B. Sample size</p> $n = \left(\frac{z}{e}\right)^2 \hat{p}(1 - \hat{p}) \quad (7-10)$ <p>Symbols:</p> <p>a = Allowable error as percentage of average time A = Allowance percentage AF = Allowance factor e = Maximum acceptable amount of time error n = Number of observations needed NT = Normal time OT = Observed, or average, time \hat{p} = Sample proportion PR = Performance rating s = Standard deviation of observed times ST = Standard time X = Sample mean X_i = Time for ith observation ($i = 1, 2, 3, \dots, n$) z = Number of standard deviations needed to achieve desired confidence</p>

TABLE 7.7
Summary of formulas

ergonomics, 305
 flow process chart, 312
 job design, 301
 job enlargement, 303
 job enrichment, 303
 job rotation, 303
 knowledge-based pay, 310
 methods analysis, 310
 micromotion study, 316

motion study, 315
 motion study principles, 315
 OSHA, 308
 output-based (incentive) system, 308
 predetermined time standards, 323
 random number table, 325
 self-directed teams, 304

specialization, 302
 standard elemental times, 322
 standard time, 316
 stopwatch time study, 318
 therbligs, 315
 time-based system, 308
 worker-machine chart, 313
 work measurement, 316
 work sampling, 323

KEY TERMS

SOLVED PROBLEMS

A time study analyst timed an assembly operation for 30 cycles, and then computed the average time per cycle, which was 18.75 minutes. The analyst assigned a performance rating of .96, and decided that an appropriate allowance was 15 percent. Assume the allowance factor is based on the *workday*. Determine the following: the observed time (OT), the normal time (NT), and the standard time (ST).

OT = Average time = 18.75 minutes
 NT = OT × Performance rating = 18.75 minutes × .96 = 18 minutes

$$AF = \frac{1}{1 - A} = \frac{1}{1 - .15} = 1.176$$
 ST = NT × AF = 18 × 1.176 = 21.17 minutes

Problem 1

Solution

A time study analyst wants to estimate the number of observations that will be needed to achieve a specified maximum error, with a confidence of 95.5 percent. A preliminary study yielded a mean of 5.2 minutes and a standard deviation of 1.1 minutes. Determine the total number of observations needed for the following two cases.

Problem 2

Solution

- a. A maximum error of ± 6 percent of the sample mean.
- b. A maximum error of .40 minute.

$$x = 5.2 \text{ minutes} \quad z = 2.00 \text{ for } 95.5, \text{ from p. 318}$$

$$s = 1.1 \text{ minutes} \quad a = .06$$

$$n = \left(\frac{zs}{ax}\right)^2 = \left(\frac{2.00(1.1)}{.06(5.2)}\right)^2 = 49.72; \text{ round to 50 observations}$$

$$e = .40$$

$$n = \left(\frac{zs}{e}\right)^2 = \left(\frac{2.00(1.1)}{.40}\right)^2 = 30.25; \text{ round to 31 observations}$$

Problem 3

Work sampling. An analyst has been asked to prepare an estimate of the proportion of time that a turret lathe operator spends adjusting the machine, with a 90 percent confidence level. Based on previous experience, the analyst believes the proportion will be approximately 30 percent.

- a. If the analyst uses a sample size of 400 observations, what is the maximum possible error that will be associated with the estimate?
- b. What sample size would the analyst need in order to have the maximum error be no more than ± 5 percent?

$$\hat{p} = .30 \quad z = 1.65 \text{ for } 90 \text{ percent confidence from p. 307}$$

Solution

$$e = z \sqrt{\frac{\hat{p}(1 - \hat{p})}{n}} = 1.65 \sqrt{\frac{.3(.7)}{400}} = .038$$

$$n = \left(\frac{z}{e}\right)^2 \hat{p}(1 - \hat{p}) = \left(\frac{1.65}{.05}\right)^2 (.3)(.7) = 228.69, \text{ or } 229$$

Problem 4

Compute the standard deviation of this data: 3 2 4 1

Step 1: Find the mean of the data.

Step 2: Subtract the mean from each data point. These differences should sum to 0.

Step 3: Square each difference and sum the squares.

Step 4: Divide the sum of the squared differences by $n - 1$.

Step 5: Compute the square root.

Solution

	<u>Step 1</u>	<u>Step 2</u>	<u>Step 3</u>	<u>Step 4</u>	<u>Step 5</u>
Data	Compute Mean	Compute Differences	Square Differences	Divide Sum by $n - 1$	Compute Square root
3	3	$3 - 2.5 = 0.5$	$0.5^2 = 0.25$		
2	2	$2 - 2.5 = -0.5$	$-0.5^2 = 0.25$		
4	4	$4 - 2.5 = 1.5$	$1.5^2 = 2.25$		
1	1	$1 - 2.5 = -1.5$	$-1.5^2 = 2.25$		
	$10/4 = 2.5$	0.0	5.00	$5/(4 - 1) = 1.66667$	$\sqrt{1.66667} = 1.297$

DISCUSSION AND REVIEW QUESTIONS

1. What is job design, and why is it important?
2. What are some of the main advantages and disadvantages of specialization from a management perspective? From a worker's perspective?
3. a. Contrast the meanings of the terms *job enlargement* and *job enrichment*.
b. What is the purpose of approaches such as job enlargement and job enrichment?
4. a. What is ergonomics and why is it important in job design?
b. Explain how it can relate to quality of work life.

5. Explain the term *knowledge-based pay system*.
 6. What are self-directed work teams? What are some potential benefits of using these teams?
 7. Some Japanese firms have a policy of rotating their managers among different managerial jobs. In contrast, American managers are more likely to specialize in a certain area (e.g., finance or operations). Discuss the advantages and disadvantages of each of these approaches. Which do you prefer? Why?
 8. What are motion study principles? How are they classified?
 9. Name some reasons why methods analyses are needed. How is methods analysis linked to productivity improvements?
 10. How are devices such as flow process charts and worker-machine charts useful?
 11. What is a time standard? What factors must be taken into account when developing standards?
 12. What are the main uses of time study information?
 13. Could performance rating be avoided by studying a group of workers and averaging their times? Explain briefly.
 14. If an average worker could be identified, what advantage would there be in using that person for a time study? What are some reasons why an average worker might not be studied?
 15. What are the main limitations of time study?
 16. Comment on the following: "At any given instant, the standard times for many jobs will not be strictly correct."
 - a. Why is this so?
 - b. Does this mean those standards are useless? Explain.
 17. Why do workers sometimes resent time studies?
 18. What are the key advantages and disadvantages of
 - a. time-based pay plans?
 - b. incentive plans?
 19. What is work sampling? How does it differ from time study?
-
1. What are the trade-offs in the following?
 - a. Using self-directed teams instead of a more conventional approach with occasional use of teams.
 - b. Deciding how often to update standard times due to minor changes in work methods.
 - c. Choosing between time study and work sampling for work measurement.
 2. Who uses the results of work measurement in an organization, and how do they use them?
 3. In what ways does technology have an impact on job design?
-
1. Healthy Hots, a fast-food restaurant that offers heart-healthy food, is experiencing several difficulties with operations. Although customers like the idea of heart-healthy foods, and surveys indicate that customers find the food to be tasty and appealing, business has fallen off in recent weeks. At this point, the restaurant is not making a profit. Customers have complained about slow service, and employee turnover is high.

Explain briefly how techniques described in this chapter could be used to improve operations. Be specific about which techniques could be used, how they could be used, and why you think those techniques would be helpful.
 2. Identify an unethical behavior for each of the five major topics in this chapter, and indicate which ethical principle (see Chapter 1) each violates.
-
1. An analyst has timed a metal-cutting operation for 50 cycles. The average time per cycle was 10.40 minutes, and the standard deviation was 1.20 minutes for a worker with a performance rating of 125 percent. Assume an allowance of 16 percent of job time. Find the standard time for this operation.

TAKING STOCK

CRITICAL THINKING EXERCISES

PROBLEMS

2. A job was timed for 60 cycles and had an average of 1.2 minutes per piece. The performance rating was 95 percent, and workday allowances are 10 percent. Determine each of the following.
 - a. observed time
 - b. normal time
 - c. standard time
3. A time study was conducted on a job that contains four elements. The observed times and performance ratings for six cycles are shown in the following table.

Element	Performance Rating	OBSERVATIONS (minutes per cycle)					
		1	2	3	4	5	6
1	90%	0.44	0.50	0.43	0.45	0.48	0.46
2	85	1.50	1.54	1.47	1.51	1.49	1.52
3	110	0.84	0.89	0.77	0.83	0.85	0.80
4	100	1.10	1.14	1.08	1.20	1.16	1.26

- a. Determine the average cycle time for each element.
- b. Find the normal time for each element.
- c. Assuming an allowance factor of 15 percent of job time, compute the standard time for this job.
4. Given these observed times (in minutes) for four elements of a job, determine the observed time (OT) for each element. *Note:* The second element only occurs every other cycle.

Element	CYCLE					
	1	2	3	4	5	6
1	4.1	4.0	4.2	4.1	4.1	4.1
2	—	1.5	—	1.6	—	1.4
3	3.2	3.2	3.3	3.2	3.3	3.3
4	2.7	2.8	2.7	2.8	2.8	2.8

5. Given these observed times (in minutes) for five elements of a job, determine the observed time (OT) for each element. *Note:* Some of the elements occur only periodically.

Element	CYCLE					
	1	2	3	4	5	6
1	2.1	2.0	2.2	2.1	2.1	—
2	—	1.1	—	1.0	—	1.2
3	3.4	3.5	3.3	3.5	3.4	3.3
4	4.0	—	—	4.2	—	—
5	1.4	1.4	1.5	1.5	1.5	1.4

6. Using Table 7.4, develop an allowance percentage for a job element that requires the worker to lift a weight of 10 pounds while (1) standing in a slightly awkward position, (2) in light that is slightly below recommended standards, and (3) with intermittent loud noises occurring. The monotony for this element is high. Include a personal allowance of 5 percent and a basic fatigue allowance of 4 percent of job time.
7. A worker-machine operation was found to involve 3.3 minutes of machine time per cycle in the course of 40 cycles of stopwatch study. The worker's time averaged 1.9 minutes per cycle, and the worker was given a rating of 120 percent (machine rating is 100 percent). Midway through the study, the worker took a 10-minute rest break. Assuming an allowance factor of 12 percent of work time, determine the standard time for this job.

8. A recently negotiated union contract allows workers in a shipping department 24 minutes for rest, 10 minutes for personal time, and 14 minutes for delays for each four hours worked. A time study analyst observed a job that is performed continuously and found an average time of 6.0 minutes per cycle for a worker she rated at 95 percent. What standard time is applicable for that operation?
9. The following data were obtained by observing a three-step job of a financial manager's assistant.
 - a. Using the data and an allowance of 10 percent of job time, determine a standard time for the operation.
 - b. Determine the number of observations that would be required to estimate the mean time for the first element within 4 percent of the true value with a confidence of 98 percent.
 - c. How many observations would be needed to estimate the mean time for element C to within .10 minute of its actual value with a confidence of 90 percent?

Element	Performance Rating	OBSERVATIONS (minutes per cycle)				
		1	2	3	4	5
A	90%	1.40	1.42	1.39	1.38	1.41
B	120	2.10	2.05	2.00	1.85	1.80
C	110	1.60	1.40	1.50	1.45	1.55

10. The data in the following table represent time study observations for a woodworking operation.
 - a. Based on the observations, determine the standard time for the operation, assuming an allowance of 15 percent of job time.
 - b. How many observations would be needed to estimate the mean time for element 2 within 1 percent of its true value with a 95.5 percent confidence?
 - c. How many observations would be needed to estimate the mean time for element 2 within .01 minute of its true value with a 95.5 percent confidence?

Element	Performance Rating	OBSERVATIONS (minutes per cycle)					
		1	2	3	4	5	6
1	110%	1.20	1.17	1.16	1.22	1.24	1.15
2	115	0.83	0.87	0.78	0.82	0.85	1.32*
3	105	0.58	0.53	0.52	0.59	0.60	0.54

*Unusual delay, disregard time.

11. How many observations should a time study analyst plan for in an operation that has a standard deviation of 1.5 minutes per piece if the goal is to estimate the mean time per piece to within .4 minute with a confidence of 95.5 percent?
12. How many work cycles should be timed to estimate the average cycle time to within 2 percent of the sample mean with a confidence of 99 percent if a pilot study yielded these times (minutes): 5.2, 5.5, 5.8, 5.3, 5.5, and 5.1? The standard deviation is .253 minutes per cycle.
13. In an initial survey designed to estimate the percentage of time air-express cargo loaders are idle, an analyst found that loaders were idle in 6 of the 50 observations.
 - a. What is the estimated percentage of idle time?
 - b. Based on the initial results, approximately how many observations would you require to estimate the actual percentage of idle time to within 5 percent with a confidence of 95 percent?
14. An analyst made the following observations about whether customer service representatives were busy (B) or idle (I):
 - a. What is the percentage of idle time?
 - b. Given these results, how many observations would be needed to estimate the actual percentage of idle time to within 6 percent with a confidence of 90 percent?

Observation	1	2	3	4	5	6	7	8	9	10	11	12	13	14	15	16	17	18	19	20
Busy or idle	B	B	I	B	I	B	B	B	I	B	B	B	B	I	B	B	B	B	B	I

15. A job in an insurance office involves telephone conversations with policyholders. The office manager estimates that about half of the employee's time is spent on the telephone. How many observations are needed in a work sampling study to estimate that time percentage to within 6 percent and have a confidence of 98 percent?
16. A hospital administrator thinks that the X-ray equipment is only in use about 20 percent of the time. What number of observations in a work sampling study would be needed to estimate the true percentage of time to within 5 percent with a confidence of 98 percent?
17. Design a schedule of work sampling observations in which eight observations are made during one eight-hour day (use 0:00 to 7:59). Using Table 7.5, read the *last digit* going down column 4 for hours (e.g., 1 7 4 4 6 . . .), and read across row 3 from left to right in sets of two for minutes (e.g., 47 15 24 86 . . .). Arrange the times chronologically.
18. The manager of a large office intends to conduct a work sampling of the time the staff spends on the telephone. The observations will be taken over a period of 50 workdays. The office is open five days a week for eight hours a day (use 0:00 to 7:59). Although the study will consist of 200 random observations, in this problem you will be asked to determine times for 11 observations. Use random numbers from Table 7.5.
 - a. Determine times for 11 observations. For days, read sets of two-digit numbers going across row 4 from left to right (e.g., 16 32 15 46 . . .), and do the same in row 5.
 - b. For hours, read one-digit numbers going down, using the first digit of column 1 (e.g., 6 4 3 1 . . .).
 - c. For minutes, read two-digit numbers going up column 4 using the first two digits (e.g., 30 46 10 . . .), and then repeat for the second two digits going up column 4 (e.g., 95 66 39 . . .).
 - d. Arrange the combinations chronologically by day, hour, and minute.
 - e. Assume March 1 is a Monday and that there are no holidays in March, April, or May. Convert your observation days to dates in March, April, and May.
19. A work sampling study is to be conducted on rush-hour traffic (4:00 p.m. to 6:59) five days per week. The study will encompass 40 days. Determine the day, hour, and minute for 10 observations using the following procedure and Table 7.5.
 - a. Read two-digit numbers going down the first two digits of column 5 (e.g., 46 20 38 . . .), and then down the second two digits of that column (e.g., 27 93 56 . . .) for days.
 - b. For hours, read one-digit numbers going from left to right across row 1 and then across row 2. (Read only 4s, 5s, and 6s.)
 - c. For minutes, read two-digit numbers going down column 6, first using the last two digits (e.g., 87 17 64 . . .), and, after exhausting those numbers, repeat using the first two digits of that column (e.g., 83 46 00 19 . . .).

Arrange your times chronologically by day, then hour, and then minute.

SELECTED BIBLIOGRAPHY AND FURTHER READINGS

- Aft, Larry. "New Tools for the Tried and True." *Industrial Engineer* (March 2013), pp. 44–49.
- Bridger, R. S. *Introduction to Ergonomics*, 3rd ed. New York: CRC Press, 2008.
- Cascio, Wayne. *Managing Human Resources: Productivity, Quality of Work Life, Profits*, 7th ed. New York: McGraw-Hill, 2006.
- Freivalds, Andris, and Benjamin Neibel. *Neibel's Methods, Standards, and Work Design*, 13th ed. New York: McGraw-Hill, 2013.
- Groover, Mikell P. *Work Systems: The Methods, Measurement, and Management of Work*. Upper Saddle River, NJ: Prentice Hall, 2007.
- Meyers, Fred E. and J. R. Stewart. *Motion and Time Study for Lean Manufacturing*, 3rd ed. Upper Saddle River, NJ: Prentice Hall, 2002.
- Mundel, Marvin E., and David L. Danner. *Motion and Time Study: Improving Productivity*, 7th ed. Englewood Cliffs, NJ: Prentice Hall, 1994.
- Salvendy, Gavriel. *Handbook of Human Factors and Ergonomics*, 4th ed. New York: Wiley, 2012.

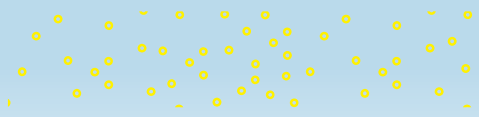

7

Learning Curves

SUPPLEMENT

LEARNING OBJECTIVES

After completing this supplement, you should be able to:

- LO7S.1** Explain the concept of a learning curve.
- LO7S.2** Make time estimates based on learning curves.
- LO7S.3** List and briefly describe some of the main applications of learning curves.
- LO7S.4** Outline some of the cautions and criticisms of learning curves.
- LO7S.5** Estimate learning rates from data on job times.

SUPPLEMENT OUTLINE

- CHAPTER 7S.1** The Concept of Learning Curves 336
 - CHAPTER 7S.2** Applications of Learning Curves 340
 - CHAPTER 7S.3** Operations Strategy 342
 - CHAPTER 7S.4** Cautions and Criticisms 342
- Case:** Product Recall 347

Learning is usually occurring when humans are involved; this is a basic consideration in the design of work systems. It is important to be able to predict how learning will affect task times and costs. This supplement addresses those issues.

7S.1 THE CONCEPT OF LEARNING CURVES

LO7S.1 Explain the concept of a learning curve.

Human performance of activities typically shows improvement when the activities are done on a repetitive basis: The time required to perform a task decreases with increasing repetitions. *Learning curves* summarize this phenomenon. The degree of improvement and the number of tasks needed to realize the major portion of the improvement is a function of the task being done. If the task is short and somewhat routine, only a modest amount of improvement is likely to occur, and it generally occurs during the first few repetitions. If the task is fairly complex and has a longer duration, improvements will occur over a longer interval (i.e., a larger number of repetitions). Therefore, learning factors have little relevance for planning or scheduling routine activities, but they do have relevance for new or complex repetitive activities, including bidding on contracts that involve complex repetitive work.

Figure 7S.1 illustrates the basic relationship between increasing repetitions and a decreasing time per repetition. It should be noted that the curve will never touch the horizontal axis; that is, the time per unit will never be zero.

The general relationship is alternatively referred to as an experience curve, a progress function, or an improvement function. Experts agree that the learning effect is the result of

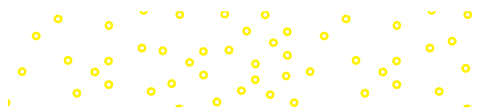

FIGURE 7S.1 The learning effect: Time per repetition decreases as the number of repetitions increases

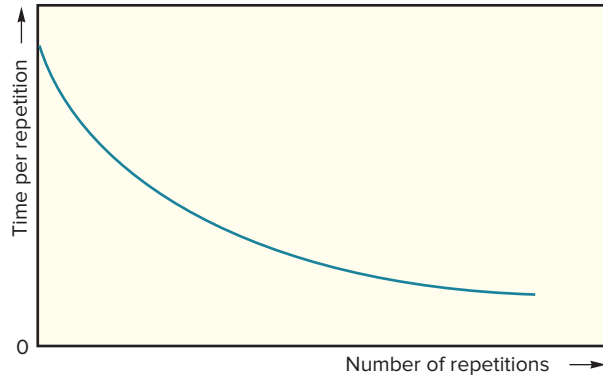
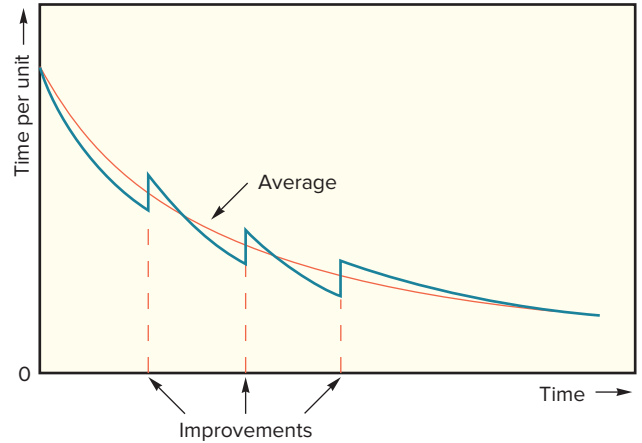

FIGURE 7S.2 Improvements may create a scallop effect in the curve



other factors in addition to actual worker learning. Some of the improvement can be traced to preproduction factors, such as selection of tooling and equipment, product design, methods analysis, and, in general, the amount of effort expended prior to the start of the work. Other contributing factors may involve changes after production has begun, such as changes in methods, tooling, and design. In addition, management input can be an important factor through improvements in planning, scheduling, motivation, and control.

Changes that are made once production is under way can cause a temporary *increase* in time per unit until workers adjust to the change, even though they eventually lead to an increased output rate. If a number of changes are made during production, the learning curve would be more realistically described by a series of scallops instead of a smooth curve, as illustrated in Figure 7S.2. Nonetheless, it is convenient to work with a smooth curve, which can be interpreted as the *average* effect.

From an organizational standpoint, what makes the learning effect more than an interesting curiosity is its *predictability*, which becomes readily apparent if the relationship is plotted on a log-log scale (see Figure 7S.3). The straight line that results reflects a constant learning percentage, which is the basis of learning curve estimates: Empirical evidence shows that every *doubling* of repetitions results in a *constant percentage* decrease in the time per repetition. This applies both to the *average* and to the *unit* time. Typical decreases range from 10 percent to 30 percent (i.e., learning percentages that range between 90 percent and 70 percent). By convention, learning curves are referred to in terms of the *complements* of their improvement rates. For example, an 80 percent learning curve denotes a 20 percent decrease in unit (or average) time with each doubling of repetitions, and a 90 percent curve denotes a 10 percent improvement rate. Note that a 100 percent curve would imply no improvement at all.

Although the doubling effect is not a practical method for estimating activity times because it doesn't yield time estimates for units that aren't in the doubling pattern, it does provide insight on the concept of reduction in unit times that occur as the number of repetitions increases.

The following example illustrates the decrease in unit times with the doubling effect for a learning rate of 80 percent, which is .80. The symbol LR represents the learning rate, and the symbol T_n represents the time for unit n (e.g., T_1 is the time for unit 1, T_2 is the time for unit 2).

FIGURE 7S.3 On a log-log graph, learning curves are straight lines

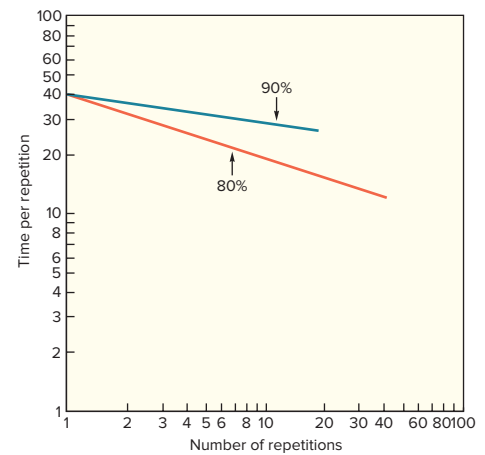

LO7S.2 Make time estimates based on learning curves.

EXAMPLE 7S-1**Computing Times Using the Doubling Effect**

An activity is known to have an 80 percent learning curve. It has taken a worker 10 hours to produce the first unit. Determine expected completion times for these units: the 2nd, 4th, 8th, and 16th (note successive doubling in the unit column).

SOLUTION

$T_1 = 10$ hr and LR = 80%

Unit	Time
1	T_1
2	$T_1 \times \text{LR} = T_2$
4	$T_2 \times \text{LR} = T_4$
8	$T_4 \times \text{LR} = T_8$
16	$T_8 \times \text{LR} = T_{16}$

Unit	Time (hours)
1	10
2	$10(.80) = 8$
3	
4	$8(.80) = 6.4$
5	
6	
7	
8	$6.4(.80) = 5.12$
9	
10	
11	
12	
13	
14	
15	
16	$5.12(.80) = 4.096$

Example 7S-1 illustrates an important point and also raises an interesting question. The point is that the time reduction *per unit* becomes less and less as the number of repetitions increases. For example, the second unit required two hours less time than the first, and the improvement from the 8th to the 16th unit was only slightly more than one hour. The question raised is: How are times computed for values such as three, five, six, seven, and other units that don't fall into this pattern?

There are two ways to obtain the times. One is to use a formula; the other is to use a table of values.

First consider the formula approach. The formula is based on the existence of a linear relationship between the time per unit and the number of units when these two variables are expressed in logarithms.

The unit time (i.e., the number of direct labor hours required) for the n th unit can be computed using the following formula:

$$T_n = T_1 \times n^b \quad (7S-1)$$

where

T_n = Time for n th unit

T_1 = Time for first unit

$b = \ln(\text{Learning percentage}) \div \ln 2$; \ln stands for the natural logarithm

To use the formula, you need to know the time for the first unit and the learning percentage. For example, for an 80 percent curve with $T_1 = 10$ hours, the time for the third unit would be computed as

$$T_3 = 10(3^{\ln .8 / \ln 2}) = 7.02$$

Note: \log can be used instead of \ln .

The second approach is to use a "learning factor" obtained from a table such as Table 7S.1. The table shows two things for some selected learning percentages. One is a unit value for the number of repetitions (unit number). This enables you to easily determine how long any unit will take to produce. The other is a cumulative value, which enables you to compute the total number of hours needed to complete any given number of repetitions. The computation for both is a relatively simple operation: Multiply the table value by the time required for the first unit.

TABLE 7S.1
Learning curve coefficients

Unit Number	70%		75%		80%		85%		90%	
	Unit Time	Total Time	Unit Time	Total Time	Unit Time	Total Time	Unit Time	Total Time	Unit Time	Total Time
1	1.000	1.000	1.000	1.000	1.000	1.000	1.000	1.000	1.000	1.000
2	.700	1.700	.750	1.750	.800	1.800	.850	1.850	.900	1.900
3	.568	2.268	.634	2.384	.702	2.502	.773	2.623	.846	2.746
4	.490	2.758	.562	2.946	.640	3.142	.723	3.345	.810	3.556
5	.437	3.195	.513	3.459	.596	3.738	.686	4.031	.783	4.339
6	.398	3.593	.475	3.934	.561	4.299	.657	4.688	.762	5.101
7	.367	3.960	.446	4.380	.534	4.834	.634	5.322	.744	5.845
8	.343	4.303	.422	4.802	.512	5.346	.614	5.936	.729	6.574
9	.323	4.626	.402	5.204	.493	5.839	.597	6.533	.716	7.290
10	.306	4.932	.385	5.589	.477	6.315	.583	7.116	.705	7.994
11	.291	5.223	.370	5.958	.462	6.777	.570	7.686	.695	8.689
12	.278	5.501	.357	6.315	.449	7.227	.558	8.244	.685	9.374
13	.267	5.769	.345	6.660	.438	7.665	.548	8.792	.677	10.052
14	.257	6.026	.334	6.994	.428	8.092	.539	9.331	.670	10.721
15	.248	6.274	.325	7.319	.418	8.511	.530	9.861	.663	11.384
16	.240	6.514	.316	7.635	.410	8.920	.522	10.383	.656	12.040
17	.233	6.747	.309	7.944	.402	9.322	.515	10.898	.650	12.690
18	.226	6.973	.301	8.245	.394	9.716	.508	11.405	.644	13.334
19	.220	7.192	.295	8.540	.388	10.104	.501	11.907	.639	13.974
20	.214	7.407	.288	8.828	.381	10.485	.495	12.402	.634	14.608
21	.209	7.615	.283	9.111	.375	10.860	.490	12.892	.630	15.237
22	.204	7.819	.277	9.388	.370	11.230	.484	13.376	.625	15.862
23	.199	8.018	.272	9.660	.364	11.594	.479	13.856	.621	16.483
24	.195	8.213	.267	9.928	.359	11.954	.475	14.331	.617	17.100
25	.191	8.404	.263	10.191	.355	12.309	.470	14.801	.613	17.713
26	.187	8.591	.259	10.449	.350	12.659	.466	15.267	.609	18.323
27	.183	8.774	.255	10.704	.346	13.005	.462	15.728	.606	18.929
28	.180	8.954	.251	10.955	.342	13.347	.458	16.186	.603	19.531
29	.177	9.131	.247	11.202	.338	13.685	.454	16.640	.599	20.131
30	.174	9.305	.244	11.446	.335	14.020	.450	17.091	.596	20.727

To find the time for an individual unit (e.g., the 10th unit), use the formula

$$T_n = T_1 \times \text{Unit time factor} \tag{7S-2}$$

Thus, for an 85 percent curve, with $T_1 = 4$ hours, the time for the 10th unit would be $4 \times .583 = 2.33$ hours. To find the time for all units up to a specified unit (e.g., the first 10 units), use the following formula:

$$\Sigma T_n = T_1 \times \text{Total time factor} \tag{7S-3}$$

Thus, for an 85 percent curve, with $T_1 = 4$ hours, the total time for all 10 units (including the time for unit 1) would be $4 \times 7.116 = 28.464$ hours.

Use of Table 7S.1 requires a time for the first unit. If for some reason the completion time of the first unit is not available, or if the manager believes the completion time for some later unit is more reliable, the table can be used to obtain an estimate of the initial time.

EXAMPLE 7S-2**Computing Estimated Times Using Table 7S.1**

Production Airplanes is negotiating a contract for the production of 20 small jet aircraft. The initial jet required the equivalent of 400 days of direct labor. The learning percentage is 80 percent. Estimate the expected number of days of direct labor for

- the 20th jet.
- all 20 jets.
- Determine the average labor time for each jet using the total labor time spent on 20 jets.

SOLUTION

Using Table 7S.1 with $n = 20$ and an 80 percent learning percentage, you find these factors: Unit time = 5.381; Total time = 10.485.

- Expected time for 20th jet: $400(.381) = 152.4$ labor days
- Expected total time for all 20: $400(10.485) = 4,194$ labor days
- Average time for 20: $4,194 \div 20 = 209.7$ labor days

EXAMPLE 7S-3**Estimating Time for Unit 1**

The manager in Example 7S-2 believes that some unusual problems were encountered in producing the first jet and would like to revise that estimate based on a completion time of 276 days for the third jet.

SOLUTION

The unit value for $n = 3$ and an 80 percent curve is .702 (Table 7S.1). Divide the actual time for unit 3 by the table value to obtain the revised estimate for unit 1's time: $276 \text{ days} \div .702 = 393.2$ labor days.

7S.2 APPLICATIONS OF LEARNING CURVES

LO7S.3 List and briefly describe some of the main applications of learning curves.

Learning curve theory has found useful applications in a number of areas, including:

- Manpower planning and scheduling
- Negotiated purchasing
- Pricing new products
- Budgeting, purchasing, and inventory planning
- Capacity planning

Knowledge of output projections in learning situations can help managers make better decisions about how many workers they will need than they could determine from decisions based on initial output rates. Of course, managers obviously recognize that improvement will occur. What the learning curve contributes is a method for quantifying expected future improvements.

Negotiated purchasing often involves contracting for specialized items that may have a high degree of complexity. Examples include aircraft, computers, and special-purpose equipment. The direct labor cost per unit of such items can be expected to decrease as the size of the order increases. Hence, negotiators first settle on the number of units and then negotiate price on that basis. The government requires learning curve data on contracts that involve large, complex items. For contracts that are terminated before delivery of all units, suppliers

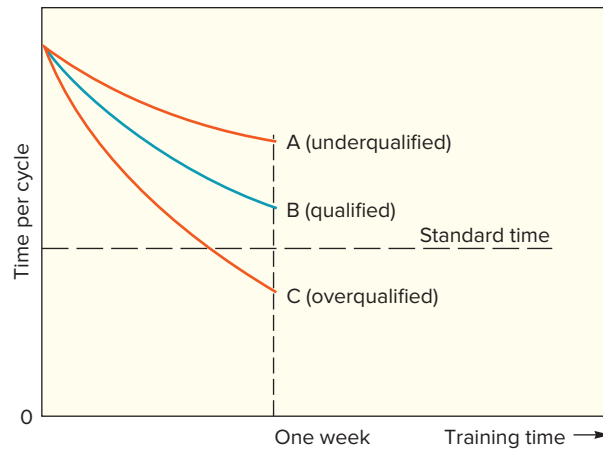
**FIGURE 7S.4**

Worker learning curves can help guide personnel job placement

can use learning curve data to argue for an increase in the unit price for the smaller number of units. Conversely, the government can use that information to negotiate a lower price per unit on follow-on orders on the basis of projected additional learning gains.

Managers must establish prices for their new products and services, often on the basis of production of a few units. Generalizing from the cost of the first few units would result in a much higher price than can be expected after a greater number of units have been produced. Actually, the manager needs to use the learning curve to avoid underpricing as well as overpricing. The manager may project initial costs by using the learning progression known to represent an organization's past experience, or else do a regression analysis of the initial results.

The learning curve projections help managers to plan costs and labor, purchasing, and inventory needs. For example, initial cost per unit will be high and output will be fairly low, so purchasing and inventory decisions can reflect this. As productivity increases, purchasing and/or inventory actions must allow for increased usage of raw materials and purchased parts to keep pace with output. Because of learning effects, the usage rate will increase over time. Hence, failure to refer to a learning curve would lead to substantial *overestimates* of labor needs and *underestimates* of the rate of material usage.

The learning principles can sometimes be used to evaluate new workers during training periods. This is accomplished by measuring each worker's performance, graphing the results, and comparing them to an expected rate of learning. The comparison reveals which workers are underqualified, qualified, and overqualified for a given type of work (see Figure 7S.4). Moreover, measuring a worker's progress can help predict whether the worker will make a quota within a required period of time.

Predicting the Number of Repetitions Needed to Achieve a Specified Unit Time

EXAMPLE 7S-4

Use learning curve theory to predict the number of repetitions (units) that will be needed for a trainee to achieve a unit time of 6 minutes if the trainee took 10 minutes to do the first unit and a learning curve of 90 percent is operative.

- Use the learning table.
- Use the log formula.

- The table approach can be used for the learning percentages that are listed across the top of the table, such as the 90 percent curve in this example. The table approach is based on Formula 7S-2:

$$T_n = T_1 \times \text{Unit table factor}$$

Setting T_n equal to the specified time of 6 minutes and solving for the unit table factor yields

SOLUTION

6 min = 10 min × Unit table factor

Solving,

Unit table factor = 6 min ÷ 10 min = .600

From Table 7S.1, under 90% in the Unit Time column, we find .599 at 29 units. Hence, approximately 29 units will be required to achieve the specified time.

b. Using the log formula,

(1) Compute the ratio of specified time to first unit time: 6 min ÷ 10 min = .600.

(2) Compute the ratio of ln learning percentage to ln 2: $\ln .90 \div \ln 2 = -0.1053605 \div 0.6931472 = -0.1520$.

(3) Find n such that $n^{-.1520} = .600$: $^{-.1520}\sqrt[.600]{} = 28.809$. Round to 29. Hence, 29 units (repetitions) will be needed to achieve a time of 6 minutes.

The learning percentage can be estimated from data on repetition times. The procedure for doing this is illustrated in Solved Problem 2.

Boeing uses learning curves to estimate weight reduction in new aircraft designs. Weight is a major factor in winning contracts because it is directly related to fuel economy.

7S.3 OPERATIONS STRATEGY

Learning curves often have strategic implications for market entry, when an organization hopes to rapidly gain market share. The use of time-based strategies can contribute to this. An increase in market share creates additional volume, enabling operations to quickly move down the learning curve, thereby decreasing costs and, in the process, gaining a competitive advantage. In some instances, the volumes are sufficiently large that operations will shift from batch mode to repetitive operation, which can lead to further cost reductions.

Learning curve projections can be useful for capacity planning. Having realistic time estimates based on learning curve theory, managers can translate that information into actual capacity needs, and plan on that basis.

7S.4 CAUTIONS AND CRITICISMS

LO7S.4 Outline some of the cautions and criticisms of learning curves.

Managers using learning curves should be aware of their limitations and pitfalls. This section briefly outlines some of the major cautions and criticisms of learning curves.

1. Learning rates may differ from organization to organization and by type of work. Therefore, it is best to base learning rates on empirical studies rather than assumed rates where possible.
2. Projections based on learning curves should be regarded as *approximations* of actual times and treated accordingly.
3. Because time estimates are based on the time for the first unit, considerable care should be taken to ensure that the time is valid. It may be desirable to revise the base time as later times become available. Because it is often necessary to estimate the time for the first unit prior to production, this caution is very important.
4. It is possible that at some point the curve might level off or even tip upward, especially near the end of a job. The potential for savings at that point is so slight that most jobs do not justify the attention or interest to sustain improvements. Then, too, some of the workers or other resources may be shifted into new jobs that are starting up.

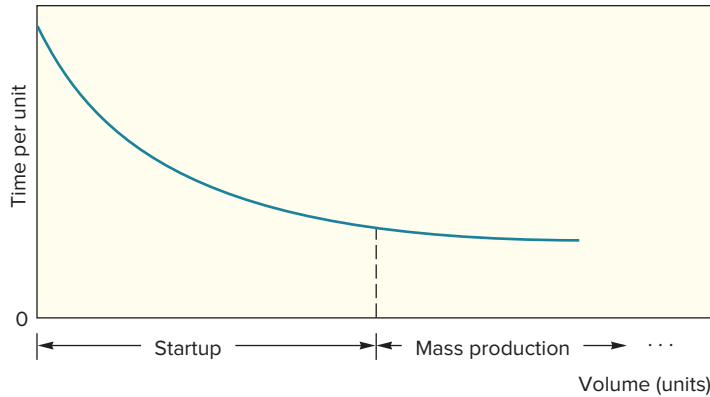

FIGURE 7S.5

Learning curves are useful for production startup, but not usually for mass production

5. Some of the improvements may be more apparent than real: Improvements in times may be due in part to *increases in indirect* labor costs such as supervision, maintenance, and material handling personnel.
6. In mass production situations, learning curves may be of initial use in predicting how long it will take before the process stabilizes. For the most part, however, the concept does *not* apply to mass production because the decrease in time per unit is imperceptible for all practical purposes (see Figure 7S.5). Also, the learning curve wouldn't apply to machine-paced operations.
7. Users of learning curves sometimes fail to include carryover effects; previous experience with similar activities can reduce activity times, although it should be noted that the *learning rate* remains the same.
8. Shorter product life cycles, flexible manufacturing, and cross-functional workers can affect the ways in which learning curves may be applied.

SOLVED PROBLEMS

An assembly operation has a 90 percent learning curve. The line has just begun work on a new item; the initial unit required 28 hours. Estimate the time that will be needed to complete

Problem 1

- a. the first five units.
- b. units 20 through 25.

Use the total time factor in the 90 percent column of Table 7S.1.

Solution

- a. Table value: 4.339.
Estimated time for five units: $28(4.339) = 121.49$ hours.
- b. The total time for units 20 through 25 can be determined by subtraction:

	Hours
Total time for 25 units:	$28(17.713) = 495.96$
<u>– Total time for 19 units:</u>	<u>$28(13.974) = 391.27$</u>
Total time for units 20 through 25	104.69

A manager wants to determine an appropriate learning rate for a new type of work his firm will undertake. He has obtained completion times for the initial six repetitions of a job of this type. What learning rate is appropriate?

Problem 2

LO7S.5 Estimate learning rates from data on job times.

Unit	Completion Time (hours)
1	15.9
2	12.0
3	10.1
4	9.1
5	8.4
6	7.5

Solution According to theory, the time per unit decreases at a constant rate each time the output *doubles* (e.g., unit 1 to 2, 2 to 4, and 3 to 6). The ratios of these observed times will give us an approximate rate. Thus,

$$\frac{\text{Unit 2}}{\text{Unit 1}} = \frac{12.0}{15.9} = .755 \qquad \frac{\text{Unit 4}}{\text{Unit 2}} = \frac{9.1}{12.0} = .758 \qquad \frac{\text{Unit 6}}{\text{Unit 3}} = \frac{7.5}{10.1} = .743$$

Not surprisingly, there is some variability; the rate is usually a smoothed approximation. Even so, the ratios are fairly close—a rate of 75 percent seems reasonable in this case.

DISCUSSION AND REVIEW QUESTIONS

1. If the learning phenomenon applies to all human activity, why isn't the effect noticeable in mass production or high-volume assembly work?
2. Under what circumstances might a manager prefer a learning rate of approximately 100 percent (i.e., no "learning")?
3. What would a learning percentage of 120 percent imply?
4. Explain how an increase in indirect labor cost can contribute to a decrease in direct labor cost per unit.
5. List the kinds of factors that create the learning effect.
6. Explain how changes in a process, once it is under way, can cause scallops in a learning curve.
7. Name some areas in which learning curves are useful.
8. What factors might cause a learning curve to tip up toward the end of a job?
9. "Users of learning curves sometimes fail to include carryover effects; previous experience with similar activities can reduce initial activity times, although it should be noted that the *learning rate* remains the same." What is the implication of this statement from the list of cautions and criticisms?
10. Identify an unethical action that involves the learning rate and the ethical principle it violates.

PROBLEMS

1. An aircraft company has an order to refurbish the interiors of 18 jet aircraft. The work has a learning curve percentage of 80. On the basis of experience with similar jobs, the industrial engineering department estimates that the first plane will require 300 hours to refurbish. Estimate the amount of time needed to complete
 - a. the fifth plane.
 - b. the first 5 planes.
 - c. all 18 planes.
2. Estimate the time it will take to complete the fourth unit of a 12-unit job involving a large assembly if the initial unit required approximately 80 hours for each of the following learning percentages.
 - a. 72 percent
 - b. 87 percent
 - c. 95 percent

3. A contractor intends to bid on a job installing 30 airport security systems. Because this will be a new line of work for the contractor, he believes there will be a learning effect for the job. After reviewing time records from a similar type of activity, the contractor is convinced that an 85 percent curve is appropriate. He estimates that the first job will take his crew eight days to install. How many days should the contractor budget for
 - a. the first 10 installations?
 - b. the second 10 installations?
 - c. the final 10 installations?
4. A job is known to have a learning percentage equal to 82. If the first unit had a completion time of 20 hours, estimate the times that will be needed to complete the third and fourth units.
5. A manager wants to determine an appropriate learning percentage for processing insurance claims for storm damage. Toward that end, times have been recorded for completion of each of the first six repetitions.

Repetition	1	2	3	4	5	6
Time (minutes)	46	39	35	33	32	30

- a. Determine the approximate learning percentage.
- b. Using your answer from part *a*, estimate the average completion time per repetition, assuming a total of 30 repetitions are planned.
6. Students in an operations management class have been assigned four similar homework problems. One student noted that it took her 50 minutes to complete the first problem. Assume that the four problems are similar and that a 70 percent learning curve is appropriate. How much time can this student plan to spend solving the remaining problems?
7. A subcontractor is responsible for outfitting six satellites that will be used for solar research. Four of the six have been completed in a total of 600 hours. If the crew has a 75 percent learning curve, how long should it take them to finish the last two units?
8. The fifth unit of a 25-unit job took 14.5 hours to complete. If a 90 percent learning curve is appropriate:
 - a. How long should it take to complete the last unit?
 - b. How long should it take to complete the 10th unit?
 - c. Estimate the average time per unit for the 25 units.
9. The labor cost to produce a certain item is \$8.50 per hour. Job setup costs \$50 and material costs are \$20 per unit. The item can be purchased for \$88.50 per unit. The learning rate is 90 percent. Overhead is charged at a rate of 50 percent of labor, materials, and setup costs.
 - a. Determine the unit cost for 20 units, given that the first unit took five hours to complete.
 - b. What is the minimum production quantity necessary to make production cost less than purchase cost?
10. A firm has a training program for a certain operation. The progress of trainees is carefully monitored. An established standard requires a trainee to be able to complete the sixth repetition of the operation in six hours or less. Those who are unable to do this are assigned to other jobs.

Currently, three trainees have each completed two repetitions. Trainee A had times of 9 hours for the first and 8 hours for the second repetition; trainee B had times of 10 hours and 8 hours for the first and second repetitions; and trainee C had times of 12 hours and 9 hours.

Which trainee(s) do you think will make the standard? Explain your reasoning.
11. The first unit of a job took 40 hours to complete. The work has a learning percentage of 88. The manager wants time estimates for units 2, 3, 4, and 5. Develop those time estimates.
12. A manager wants to estimate the remaining time that will be needed to complete a five-unit job. The initial unit of the job required 12 hours, and the work has a learning percentage of 77. Estimate the total time remaining to complete the job.
13. Kara is supposed to have a learning percentage of 82. Times for the first four units were 30.5, 28.4, 27.2, and 27.0 minutes. Does a learning percentage of 82 seem reasonable? Justify your answer using appropriate calculations.

14. The fifth unit of a 10-unit job took five hours to complete. The sixth unit has been worked on for two hours, but is not yet finished. Estimate the *additional* amount of time needed to finish the 10-unit job if the work has a 75 percent learning rate.
15. Estimate the number of repetitions each of the workers listed in the following table will require to reach a time of seven hours per unit. Time is in hours.

Trainee	T_1	T_2
Art	11	9.9
Sherry	10.5	8.4
Dave	12	10.2

16. Estimate the number of repetitions that new service worker Irene will require to achieve “standard” if the standard is 18 minutes per repetition. She took 30 minutes to do the initial repetition and 25 minutes to do the next repetition.
17. Estimate the number of repetitions each of the workers listed in the following table will require to achieve a standard time of 25 minutes per repetition. Time is in minutes.

Trainee	T_1	T_2
Beverly	36	31
Max	40	36
Antonio	37	30

18. A research analyst performs database searches for a variety of clients. According to her log, a new search requires approximately 55 minutes. Repeated requests on the same or similar topic take less and less time, as her log shows.

Request no.	1	2	3	4	5	6	7	8
Time (min.)	55.0	41.0	35.2	31.0	28.7	26.1	24.8	23.5

How many more searches will it take until the search time gets down to 19 minutes?

19. A job has an 85 percent learning curve. Estimate the time needed to complete the fifth unit of the job. The time for the first unit is unknown. However, units 2 through 4 took a total of 28.14 hours to complete.



An automobile manufacturer is conducting a product recall after it was discovered that a possible defect in the steering mechanism could cause loss of control in certain cars. The recall covers a span of three model years. The company sent out letters to car owners promising to repair the defect at no cost at any dealership.

The company's policy is to pay the dealer a fixed amount for each repair. The repair is somewhat complicated, and the company expected learning to be a factor. In order to set a reasonable rate for repairs, company engineers conducted a number of repairs themselves. It was then decided that a rate of \$88 per repair would be appropriate, based on a flat hourly rate of \$22 per hour and a 90 percent learning rate.

Shortly after dealers began making repairs, the company received word that several dealers were encountering resistance from workers who felt the flat rate was much too low and who were threatening to refuse to work on those jobs.

One of the dealers collected the following data on job times and sent that information to the company: Three mechanics each completed two repairs. Average time for the first unit was 9.6 hours, and average time for the second unit was 7.2 hours.

Given these data, the dealer has suggested a rate of \$110 per repair. You have been asked to investigate the situation and to prepare a report.

Questions and Tasks

1. Prepare a list of questions you will need answered in order to analyze this situation.
2. Prepare a list of observations regarding the information provided in the case.
3. What preliminary thoughts do you have on solutions or partial solutions to the points you have raised?

Jaber, Mohamad Y. (ed.) *Learning Curves: Theory, Models, and Applications*. Boca Raton, FL: CRC Press, 2011.

Teplitz, Charles J. *The Learning Curve Deskbook*. Westport, CT: Greenwood, 1991.

**SELECTED
BIBLIOGRAPHY AND
FURTHER READINGS**

8

CHAPTER

Location Planning and Analysis

LEARNING OBJECTIVES

After completing this chapter, you should be able to:

- LO8.1** Identify some of the main reasons organizations need to make location decisions.
- LO8.2** Explain why location decisions are important.
- LO8.3** Discuss the options available for location decisions.
- LO8.4** Discuss key considerations related to global location decisions.
- LO8.5** Outline the decision process for making location decisions.
- LO8.6** Describe some of the key factors that guide service and retail location decisions.
- LO8.7** Use the techniques presented to evaluate location alternatives.

CHAPTER OUTLINE

- | | | |
|---|--|--|
| <p>8.1 The Need for Location Decisions 350</p> <p>8.2 The Nature of Location Decisions 350</p> <p>Strategic Importance of Location Decisions 350</p> <p>Objectives of Location Decisions 351</p> <p>Supply Chain Considerations 351</p> <p>Location Options 352</p> <p>8.3 Global Locations 352</p> <p>Facilitating Factors 352</p> <p>Benefits 352</p> <p>Disadvantages 353</p> | <p>Risks 354</p> <p>Managing Global Operations 354</p> <p>Automation 354</p> <p>8.4 General Procedure for Making Location Decisions 355</p> <p>8.5 Identifying a Country, Region, Community, and Site 356</p> <p>Identifying a Country 357</p> <p>Identifying a Region 358</p> <p>Identifying a Community 359</p> <p>Identifying a Site 360</p> <p>Multiple Plant Manufacturing Strategies 361</p> | <p>Geographic Information Systems 362</p> <p>8.6 Service and Retail Locations 363</p> <p>8.7 Evaluating Location Alternatives 364</p> <p>Locational Cost-Profit-Volume Analysis 364</p> <p>The Transportation Model 366</p> <p>Factor Rating 367</p> <p>The Center-of-Gravity Method 368</p> <p>Case: Hello, Walmart? 377</p> |
|---|--|--|



Lee Snider Photo Images/Shutterstock

When a well-known real estate broker was asked what the three most important determinants of the value of a property are, he said, “That’s easy. Location, location, and location.”

In the residential real estate market, location is an important factor. Although the style of house, number of bedrooms and bathrooms, level of maintenance, and modernity of the kitchen undoubtedly enter into the picture, some locations are just more desirable than others.

In many respects, the choice of location for a business organization is every bit as important as it is for a house, although for different reasons.

Location decisions represent a key part of the strategic planning process of virtually every organization. And, although it might appear that location decisions are one-time problems pertaining to new organizations, existing organizations often have a bigger stake in these kinds of decisions than new organizations.

This chapter examines location analysis. It begins with a brief overview of the reasons firms must make location decisions, the nature of these decisions, and a general procedure for developing and evaluating location alternatives.

8.1 THE NEED FOR LOCATION DECISIONS

LO8.1 Identify some of the main reasons organizations need to make location decisions.

Existing organizations may need to make location decisions for a variety of reasons. Firms such as banks, fast-food chains, supermarkets, and retail stores view locations as part of marketing strategy, and they look for locations that will help them to expand their markets. Conversely, when a chain decides to close some of its stores, the question becomes which ones to keep.

When an organization experiences a growth in demand for its products or services that cannot be satisfied by expansion at an existing location, the addition of a new location to complement an existing system is often a realistic alternative.

Some firms face location decisions through depletion of basic inputs. For example, logging operations are often forced to relocate due to the temporary exhaustion of trees at a given location. Fishing operations can be affected by seasons as well as government limits on the amount of fish. Mining and petroleum operations face the same sort of situation, although usually with a longer time horizon.

For other firms, a shift in markets causes them to consider relocation, or the costs of doing business at a particular location reach a point where other locations begin to look more attractive.

8.2 THE NATURE OF LOCATION DECISIONS

LO8.2 Explain why location decisions are important.

Location decisions for many types of businesses are made infrequently, but they tend to have a significant impact on the organization. In this section, we look at the importance of location decisions, the usual objectives managers have when making location choices, and some of the options available to them.

Strategic Importance of Location Decisions

Location decisions are closely tied to an organization's strategies. For example, a strategy of being a low-cost producer might result in locating where labor or material costs are low, or locating near markets or raw materials to reduce transportation costs. A strategy of increasing profits by increasing market share might result in locating in high-traffic areas, and a strategy that emphasizes convenience for the customer might result in having many locations where

An aerial view of an oil plant along the Kill Van Kull, Bayonne, New Jersey. Sea transportation was a key consideration in its location. The Kill Van Kull has been one of the most important channels in commerce throughout the region, providing a passage for marine traffic between Manhattan and the industrial towns of New Jersey. It currently provides the principal access for oceangoing container ships to Port Newark–Elizabeth Marine Terminal, the busiest port facility in the eastern United States and the principal marine terminal for New York Harbor.



iofoto/123RF

customers can transact their business or make purchases (e.g., branch banks, ATMs, service stations, fast-food outlets).

Location choices can impact capacity and flexibility. Certain locations may be subject to space constraints that limit future expansion options. Moreover, local restrictions may restrict the types of products or services that can be offered, thus limiting future options for new products or services. In some situations, locating near a highway or expressway or a rail line can have benefits for shipping.

Location decisions are strategically important for other reasons as well. One is that they entail a long-term commitment, which makes mistakes difficult to overcome. Another is that location decisions often have an impact on investment requirements, operating costs and revenues, and operations. A poor choice of location might result in excessive transportation costs, a shortage of qualified labor, loss of competitive advantage, inadequate supplies of raw materials, or some similar condition that is detrimental to operations. For services, a poor location could result in lack of customers and/or high operating costs. For both manufacturing and services, location decisions can have a significant impact on competitive advantage. Another reason for the importance of location decisions is their strategic importance to supply chains.

Objectives of Location Decisions

As a general rule, profit-oriented organizations base their decisions on profit potential, whereas nonprofit organizations strive to achieve a balance between cost and the level of customer service they provide. It would seem to follow that all organizations attempt to identify the “best” location available. However, this is not necessarily the case.

In many instances, no single location may be significantly better than the others. There may be numerous acceptable locations from which to choose, as shown by the wide variety of locations where successful organizations can be found. Furthermore, the number of possible locations that would have to be examined to find the best location may be too large to make an exhaustive search practical. Consequently, most organizations do not set out with the intention of identifying the *one best* location; rather, they hope to find a number of *acceptable* locations from which to choose.

Some Internet-based retail businesses are much less dependent on location decisions such as Netflix; they can exist just about anywhere, while others that rely heavily on shipping, such as Amazon, must carefully consider where certain facilities such as warehouses are.

Supply Chain Considerations

Location criteria can depend on where a business is in the *supply chain*. For instance, at the retail end of a chain, site selection tends to focus more on accessibility, consumer demographics (population density, age distribution, average buyer income), traffic patterns, and local customs. Businesses at the beginning of a supply chain, if they are involved in supplying raw materials, are often located near the source of the raw materials. Businesses in the middle of the chain may locate near suppliers or near their markets, depending on a variety of circumstances. For example, businesses involved in storing and distributing goods often choose a central location to minimize distribution costs.

Supply chain management must address supply chain configuration. This includes determining the number and location of suppliers, production facilities, warehouses, and distribution centers. The location of these facilities can involve a long-term commitment of resources, so known risks and benefits should be considered carefully. A related issue is whether to have centralized or decentralized distribution. Centralized distribution generally yields scale economies as well as tighter control than decentralized distribution, but it sometimes incurs higher transportation costs. Decentralized distribution tends to be more responsive to local needs.

The importance of these decisions is underscored by the fact that they reflect the basic strategy for accessing customer markets, and the decisions will have a significant impact on costs, revenues, and responsiveness.

The quantitative techniques described in this chapter can be helpful in evaluating alternative supply chain configurations. Also, Chapter 15, Supply Chain Management, provides additional insights.

Location Options

Managers of existing companies generally consider four options in location planning.

Expand an existing facility. This option can be attractive if there is adequate room for expansion, especially if the location has desirable features that are not readily available elsewhere. Expansion costs are often less than those of other alternatives.

Add new locations while retaining existing ones. This is done in many retail operations. In such cases, it is essential to take into account what the impact will be on the total system. Opening a new store in a shopping mall may simply draw customers who already patronize an existing store in the same chain, rather than expand the market. On the other hand, adding locations can be a defensive strategy designed to maintain a market share or to prevent competitors from entering a market.

Shut down at one location and move to another. An organization must weigh the costs of a move and the resulting benefits against the costs and benefits of remaining in an existing location. A shift in markets, exhaustion of raw materials, and the cost of operations often cause firms to consider this option seriously.

Do nothing. If a detailed analysis of potential locations fails to uncover benefits that make one of the previous three alternatives attractive, a firm may decide to maintain the status quo, at least for the time being.

LO8.3 Discuss the options available for location decisions.

8.3 GLOBAL LOCATIONS

Globalization has opened new markets, and it has meant increasing dispersion of manufacturing and service operations around the world. In addition, many companies are outsourcing operations to other companies in foreign locations. In the past, companies tended to operate from a “home base” that was located in a single country. Now, companies are finding strategic and tactical reasons to globalize their operations. As they do, some companies are profiting from their efforts, while others are finding the going tough, and all must contend with issues involved in managing global operations.

In this section, we examine some of the reasons for globalization, the benefits, disadvantages, risks, and issues related to managing global operations.

Facilitating Factors

A number of factors have made globalization attractive and feasible for business organizations. Two key factors are trade agreements and technological advances.

Trade Agreements. Barriers to international trade such as tariffs and quotas can have a detrimental effect on trade, while trade agreements that are fair to all sides can help trade to flourish. The European Union has dropped many trade barriers, and the World Trade Organization is helping to facilitate free trade.

Technology. Technological advances in communication and information sharing have been very helpful. These include texting, e-mail, cell phones, teleconferencing, and the internet.

Benefits

Companies are discovering a wide range of benefits in globalizing their operations. The following is a list of some of the benefits, although it is important to recognize that not all benefits apply to every situation.

Markets. Companies often seek opportunities for expanding markets for their goods and services, as well as better serving existing customers by being more attuned to local needs and having a quicker response time when problems occur.

Cost savings. Among the areas for potential cost savings are transportation costs, labor costs, raw material costs, and taxes. High production costs in Germany have contributed



Richard J Greenman/Alamy Stock Photo

A worker inspects cans of Coca-Cola on the production line at a plant in the Middle East. Coke production overseas expands markets and serves local customers.

to a number of German companies locating some of their production facilities in lower-cost countries. Among them are the following: industrial products giant Siemens; AG (a semiconductor plant in Britain); drug makers Bayer AG (a plant in Texas) and Hoechst AG (a plant in China); and automakers Mercedes (plants in Spain, France, and Alabama) and BMW (a plant in Spartanburg, South Carolina).

Legal and regulatory. There may be more favorable liability and labor laws, and less-restrictive environmental and other regulations.

Financial. Companies can avoid the impact of currency changes and tariffs that can occur when goods are produced in one country and sold in other countries. Also, a variety of incentives may be offered by national, regional, or local governments to attract businesses that will create jobs and boost the local economy. For example, state incentives, and workforce and land availability and cost, helped convince Nissan to build a huge assembly plant in Canton, Mississippi, and Mercedes to build an assembly plant in Vance, Alabama. An added benefit came when suppliers for these plants also set up facilities in the region.

Other. Globalization may provide new sources of ideas for products and services, new perspectives on operations, and solutions to problems.

Disadvantages

There are a number of disadvantages of having global operations. These can include the following:

Transportation costs. High transportation costs can occur due to poor infrastructure or having to ship over great distances, and the resulting costs can offset savings in labor and materials costs.

Security costs. Increased security risks and theft can increase costs. Also, security at international borders can slow shipments to other countries.

Unskilled labor. Low labor skills may negatively impact quality and productivity, and the work ethic may differ from that in the home country. Additional employee training may be required.

Import restrictions. Some countries place restrictions on the importation of manufactured goods, thus having local suppliers avoids those issues.

LO8.4 Discuss key considerations related to global location decisions.

Criticisms. Critics may argue that cost savings are being generated through unfair practices such as using sweatshops, in which employees are paid low wages and made to work in poor conditions; using child labor; and operating in countries that have less stringent environmental requirements.

Productivity. Low labor productivity may offset low labor costs or other advantages.

Risks

Risks with global operations can be substantial. Among the most troublesome are the following:

Protecting intellectual property rights. Companies that outsource production to foreign countries need to have assurance that intellectual property rights will be preserved. There are many instances in some countries of not doing so, and that enables others in those countries to produce similar or identical goods with no benefit to the original company, and instead, are able to produce products that compete with the original company using intellectual property gained from that company.

Political. Political instability and political unrest can create risks for personnel safety and the safety of assets. Moreover, a government might decide to nationalize facilities, taking them over.

Terrorism. Terrorism continues to be a threat in many parts of the world, putting personnel and assets at risk and decreasing the willingness of domestic personnel to travel to or work in certain areas.

Economic. Economic instability might create inflation or deflation, either of which can negatively impact profitability.

Legal. Laws and regulations may change, reducing or eliminating what may have been key benefits.

Ethical. Corruption and bribery, common in some countries, may be illegal in a company's home country. This poses a number of issues. One is how to maintain operations without resorting to bribery. Another is how to prevent employees from doing this, especially when they may be of local origin and used to transacting business in this way.

Cultural. Cultural differences may be more real than apparent. Walmart discovered that fact when it opened stores in Japan. Although Walmart has thrived in many countries on its reputation for low-cost items, Japanese consumers associated low cost with low quality, so Walmart had to rethink its strategy for the Japanese market.

Quality. Lax quality controls can lead to recalls and liability issues.

Managing Global Operations

Although global operations offer many benefits, these operations often create new issues for management to deal with. For example, language and cultural differences increase the risk of miscommunication and may also interfere with developing trust that is important in business relationships. Management styles may be quite different, so tactics that work well in one country may not work in another. Increased travel distances and related travel times and costs may result in a decreased tendency for face-to-face meetings and management site visits. Also, coordination of far-flung operations can be more difficult. Managers may have to deal with corruption and bribery, as well as differences in work ethic. The level of technology may be lower, and the resistance to technological change may be higher than expected, making the integration of new technologies more difficult. Domestic personnel may resist relocating, even temporarily.

Automation

Automation is having a major influence on the decision of where to produce goods, particularly if the main markets are domestic. Low labor costs in foreign locations have long been cited as a key reason for using foreign locations for production. However, rising labor costs in



BY LISA SPENCER

With nearly 30,000 stores in 78 countries, coffee powerhouse Starbucks continues its push for global growth. However, serious challenges face the coffee giant. In the United States, market saturation looms as Starbucks stores abound and may cannibalize each other's sales. In addition, competitors attack, with many players aiming to take shares from Starbucks. McDonald's McCafe has proven popular among cost-conscious American consumers, while more upscale competitors like Blue Bottle Coffee are also gaining popularity. To maintain its competitive edge, Starbucks plans for about 2,000 of its company-owned stores to partner with UberEats for coffee delivery service. Greater use of technology in the ordering process will free employees to spend more time with customers, enhancing the service aspect of the business. The company is also using big data to study consumer preferences and create new products.¹

With half of its shops in the United States, China is Starbucks' second biggest market, where over 150 cities are home to more than 3,600 shops. CEO Kevin Johnson plans a new delivery program from 2,000 of those stores, as well as a new virtual store on the Alibaba e-commerce platform, potentially reaching 600 million Chinese consumers. In addition, Shanghai boasts one of Starbucks' four Roasteries that have been opened worldwide. At 30,000 square feet, these premium coffeehouse showpieces allow customers to experience coffee roasting firsthand, sampling specialty products in a high-end atmosphere.¹ A recent partnership with rival Nestlé to sell packaged coffee products in grocery stores and restaurants around the world is yet another way Starbucks is seeking to add to its bottom line and expand its reach.¹

Competitors aim for the lucrative market, as Chinese consumers increasingly reach for coffee. Starbucks' new CEO, Kevin Johnson, calls the Chinese competition "highly promotional and disruptive."² Luckin Coffee, which began in late 2017 in Beijing, opened nearly 2,000 stores in just over a year, with plans to reach 4,500 stores soon. Luckin's business model has special appeal among younger Chinese consumers, featuring a smaller store

format, fast delivery, and plenty of technology. For Starbucks, the bigger problem is Luckin's prices, which are 20 percent lower. Price-sensitive Chinese consumers may be drawn to that difference if the Chinese economy slows.³

China has several consumer market segments, each with its own buying preferences. In the east, regions including Hong Kong, Guangzhou, Shanghai, and Beijing are home to highly globalized consumers with shopping preferences similar to those in developed Western economies. On the other hand, in central and western China, rural communities prefer local, Chinese companies and products. Finally, a third segment is a hybrid, embracing both global and local buying habits, in large cities like Fuzhou, Shantou, and Huizhou. So far, Starbucks has chosen the low-hanging fruit by opening in the east, where consumers have readily accepted its products. Moving into more rural or hybrid areas may pose more of a challenge, if Starbucks chooses to pursue those markets at all.²

1. Will Starbucks be able to successfully battle competition at home and abroad as it continues its march for global growth?
2. What are some key differences among the various countries that Starbucks serves, and how can it capitalize on these for future success?
3. What advantages might Starbucks have over local coffee businesses in global markets? In what way is it at a disadvantage to existing coffee houses in other countries?

Based on:

¹Andrew Cheng, "How Starbucks Plans to Roast Its Coffeehouse Competition." January 25, 2019. <https://www.forbes.com/sites/andriacheng/2019/01/25/how-starbucks-plans-to-roast-its-coffeehouse-competition/#3cc9d4b1247a>

²Lila MacLellan, "The Countries with the Most Starbucks Locations." *Quartz*, January 30, 2019. <https://qz.com/1536009/the-countries-with-the-most-starbucks-locations/>

³Panos Mourdoukoutas, "Starbucks' Worst Nightmare in China Is Coming True." January 21, 2019. <https://www.forbes.com/sites/panosmourdoukoutas/2019/01/21/starbucks-worst-nightmare-in-china-is-coming-true/#1aca18ad17ec>

some developing countries and poor safety records, the benefits of short transportation times with domestic locations, and advances in automation are causing many companies to take a new look at the question of where production should be done.

8.4 GENERAL PROCEDURE FOR MAKING LOCATION DECISIONS

The way an organization approaches location decisions often depends on its size and the nature or scope of its operations. New or small organizations tend to adopt a rather informal approach to location decisions. New firms typically locate in a certain area simply because the owner lives there. Similarly, managers of small firms often want to keep operations in their backyard, so they tend to focus almost exclusively on local alternatives. Large established companies,

LO8.5 Outline the decision process for making location decisions.

Cargo trucks carry containers in and out of the Port of Singapore. The terminal is the world's second busiest (now surpassed by the Port of Shanghai), handling about one-fifth of the world's total container transshipments. It connects with 200 shipping lines with connections to 600 ports in 123 countries. This includes daily sailings to every major port in the world.



delcreations/123RF

particularly those that already operate in more than one location, tend to take a more formal approach. Moreover, they usually consider a wider range of geographic locations. The discussion here pertains mainly to a formal approach to location decisions.

The general procedure for making location decisions usually consists of the following steps:

1. Decide on the criteria to use for evaluating location alternatives, such as increased revenues, decreased cost, or community service.
2. Identify important factors, such as the location of markets or raw materials. The factors will differ depending on the type of facility. For example, retail, manufacturing, distribution, health care, and transportation all have differing factors that guide their location decisions.
3. Develop location alternatives:
 - a. Identify a country or countries for a location.
 - b. Identify the general region for a location.
 - c. Identify a small number of community alternatives.
 - d. Identify site alternatives among the community alternatives.
4. Evaluate the alternatives and make a selection.

Step 1 is simply a matter of managerial preference. Steps 2 through 4 are discussed on the following pages.

8.5 IDENTIFYING A COUNTRY, REGION, COMMUNITY, AND SITE

Many factors influence location decisions. However, it often happens that one or a few factors are so important that they dominate the decision. For example, in manufacturing, the potentially dominating factors usually include availability of an abundant energy and water supply and proximity to raw materials. Thus, nuclear reactors require large amounts of water

for cooling and inexpensive land, heavy industries such as steel and aluminum production need large amounts of electricity, and so on. Transportation costs can be a major factor. In service organizations, possible dominating factors are market related and include traffic patterns, convenience, and competitors' locations, as well as proximity to the market. For example, car rental agencies locate near airports and midcity, where their customers are. Note, too, that many of the factors discussed pertain to supply chain facilities as well as operations facilities.

Once an organization has determined the most important factors, it will try to narrow the search for suitable alternatives to one geographic region. Then, a small number of community-site alternatives are identified and subjected to detailed analysis. Human factors can be very important, as the following reading reveals. These might include the “culture shock” that is often experienced when employees are transferred to an environment that differs significantly from the current location—for instance, a move from a large city to a rural area, or from a rural area to a large city, or a move to an area that has a dramatically different climate.

Identifying a Country

Each country carries its own set of potential benefits and risks, and decision makers need to be absolutely clear on what those benefits and risks are, as well as their likelihood of occurrence so they can make an informed judgment on whether locating in that country is desirable. Some important issues have been noted in the previous section on global operations. Table 8.1 provides a listing of factors to consider.

In a report by the Council on Competitiveness and Deloitte Touche Tohmatsu that surveyed 400 global CEOs on their views on manufacturing competitiveness, the top three factors in determining where to locate manufacturing facilities were talent, labor costs, and energy costs.¹ And, in fact, many companies have outsourced some of their operations to foreign suppliers to take advantage of relatively low wage rates. Some U.S. manufacturing companies set up foreign subsidiaries to not only take advantage of low labor rates but also to avoid or delay paying taxes on their profits. With foreign-based subsidiaries, manufacturing

Government	<ul style="list-style-type: none"> a. Policies on foreign ownership of production facilities <ul style="list-style-type: none"> Local content requirements Import restrictions Currency restrictions Environmental regulations Local product standards Liability laws b. Stability issues
Cultural differences	<ul style="list-style-type: none"> Living circumstances for foreign workers and their dependents Ways of doing business Religious holidays/traditions
Customer preferences	<ul style="list-style-type: none"> Possible “buy locally” sentiment
Labor	<ul style="list-style-type: none"> Level of training and education of workers Wage rates Labor productivity Work ethic Possible regulations limiting number of foreign employees Language differences
Resources	<ul style="list-style-type: none"> Availability and quality of raw materials, energy, transportation infrastructure
Financial	<ul style="list-style-type: none"> Financial incentives, tax rates, inflation rates, interest rates
Technological	<ul style="list-style-type: none"> Rate of technological change, rate of innovations
Market	<ul style="list-style-type: none"> Market potential, competition
Safety	<ul style="list-style-type: none"> Crime, terrorism threat

TABLE 8.1

Factors relating to foreign locations

¹*Newsweek*, July 19, 2010, p. 15.

companies can ship their products to the United States and pay low tariffs. Furthermore, they can avoid taxes altogether by recording the profits overseas and not returning the earnings to the United States. They can do this through *transfer pricing rules* that allow U.S. companies to establish a price for transfer into the United States that keeps most of the profit in the foreign subsidiary. Those earnings are not subject to U.S. taxes unless or until they are returned as dividends to the U.S. parent corporation.

It is important to take all factors into account when contemplating the advantage of low labor costs. Other costs may negate that advantage. For example, low wage rates may also be accompanied by low *labor productivity*, resulting in a net cost per unit that is actually higher than what could be achieved domestically. Another consideration is transportation costs, which are generally higher for longer distances. Again, that could offset some or all of the low wage benefit. Then, too, longer transport time results in increased supply chain inventory, risk of losses or delays during shipping (e.g., weather issues, dock workers, strikes), and hence, reduced agility. Also, companies are increasingly taking sustainability factors in a country into account, both with respect to workers and to the environment.

Another factor to consider is the *currency and exchange rate risk* that occurs when producing in one country and buying or selling in another country. Companies must transact business in the currency of the country they are involved in. However, because the value of a country's currency fluctuates, exchange rates fluctuate, affecting the cost of supplies and the profits of sales in other countries when converting back to the country the company is located in.

Companies can obtain information about countries of interest from a variety of sources. The following are two useful websites:

CIA—<https://www.cia.gov/library/publications/the-world-factbook/index.html>

World Bank—<https://www.worldbank.org/>

Identifying a Region

The primary regional factors involve raw materials, markets, and labor considerations.

Location of Raw Materials. Firms locate near or at the source of raw materials for three primary reasons: necessity, perishability, and transportation costs. Mining operations, farming, forestry, and fishing fall under *necessity*. Obviously, such operations must locate close to the raw materials. Firms involved in canning or freezing of fresh fruits and vegetables, processing of dairy products, baking, and so on, must take into account *perishability* when considering location. *Transportation costs* are important in industries where processing eliminates much of the bulk connected with a raw material, making it much less expensive to transport the product or material after processing. Examples include aluminum reduction, cheese making, and paper production. When inputs come from different locations, some firms choose to locate near the geographic center of the sources. For instance, steel producers sometimes use large quantities of both coal and iron ore, and many are located somewhere between the Appalachian coal fields and iron ore mines. Transportation costs are often the reason that vendors locate near their major customers. Moreover, regional warehouses are used by supermarkets and other retail operations to supply multiple outlets. Often, the choice of new locations and additional warehouses reflects the locations of existing warehouses or retail outlets.

Location of Markets. Profit-oriented firms frequently locate near the markets they intend to serve as part of their competitive strategy, whereas nonprofit organizations choose locations relative to the needs of the users of their services. Other factors include distribution costs or the perishability of a finished product.

Competitive pressures for retail operations can be extremely vital factors. In some cases, a market served by a particular location may be too small to justify two or more competitors (e.g., one hamburger franchise per block), so that a search for potential locations tends to concentrate on locations without competitors. The opposite also might be true; it could be desirable to locate near competitors. Large department stores often locate near each other, and small stores like to locate in shopping centers that have large department stores as anchors.

The large stores attract large numbers of shoppers who become potential customers in the smaller stores or in the other large stores.

Some firms must locate close to their markets because of the perishability of their products. Examples include bakeries, flower shops, and fresh seafood stores. For other types of firms, distribution costs are the main factor in closeness to market. For example, sand and gravel dealers usually serve a limited area because of the high distribution costs associated with their products. Still other firms require close customer contact, so they too tend to locate within the area they expect to serve. Typical examples are tailor shops, home remodelers, home repair services, cabinetmakers, rug cleaners, and lawn and garden services.

Locations of many government services are near the markets they are designed to serve. Hence, post offices are typically scattered throughout large metropolitan areas. Police and emergency health care locations are frequently selected on the basis of client needs. For instance, police patrols often concentrate on high crime areas, and emergency health care facilities are usually found in central locations to provide ready access from all directions.

Many foreign manufacturing companies have located manufacturing operations in the United States, because it is a major market for their products. Chief among them are automobile manufacturers, most notably Japanese, but other nations are also represented. Another possible reason that Japanese producers decided to locate in the United States was to offset possible negative consumer sentiment related to job losses of U.S. workers. Thousands of U.S. autoworkers are now employed in U.S. manufacturing plants of Japanese and other foreign companies.

Labor Factors. Primary labor considerations are the cost and availability of labor, wage rates in an area, labor productivity and attitudes toward work, and whether unions are a serious potential problem.

Labor costs are very important for labor-intensive organizations. The shift of the textile industry from the New England states to southern states was due partly to labor costs.

Skills of potential employees may be a factor, although some companies prefer to train new employees rather than rely solely on previous experience. Increasing specialization in many industries makes this possibility even more likely than in the past. Although most companies concentrate on the supply of blue-collar workers, some firms are more interested in scientific and technical people as potential employees, and they look for areas with high concentrations of those types of workers.

Worker attitudes toward turnover, absenteeism, and similar factors may differ among potential locations—workers in large urban centers may exhibit different attitudes than workers in small towns or rural areas. Furthermore, worker attitudes in different parts of the country or in different countries may be markedly different.

Some companies offer their current employees jobs if they move to a new location. However, in many instances, employees are reluctant to move, especially when it means leaving families and friends. Furthermore, in families with two wage earners, relocation would require that one wage earner give up a job and then attempt to find another job in the new location.

Other Factors. Climate and taxes sometimes play a role in location decisions. For example, a string of unusually severe winters in northern states may cause some firms to seriously consider moving to a milder climate, especially if delayed deliveries and work disruptions caused by inability of employees to get to work have been frequent. Similarly, the business and personal income taxes in some states reduce their attractiveness to companies seeking new locations. Many companies have been attracted to some Sun Belt states by ample supplies of low-cost energy or labor, the climate, and tax considerations. Also, tax and monetary incentives are major factors in attracting or keeping professional sports franchises.

Identifying a Community

Many communities actively try to attract new businesses, offering financial and other incentives, because they are viewed as potential sources of future tax revenues and new job opportunities. However, communities do not, as a rule, want firms that will create pollution

problems or otherwise lessen the quality of life in the community. Local groups may actively seek to exclude certain companies on such grounds, and a company may have to go to great lengths to convince local officials that it will be a “responsible citizen.” Furthermore, some organizations discover that even though overall community attitude is favorable, there may still be considerable opposition to specific sites from nearby residents who object to possible increased levels of noise, traffic, or pollution. Examples of this include community resistance to airport expansion, changes in zoning, construction of nuclear facilities, and highway construction.

From a company standpoint, a number of factors determine the desirability of a community as a place for its workers and managers to live. They include facilities for education, shopping, recreation, transportation, religious worship, and entertainment; the quality of police, fire, and medical services; local attitudes toward the company; and the size of the community. Community size can be particularly important if a firm will be a major employer in the community; a future decision to terminate or reduce operations in that location could have a serious impact on the economy of a small community.

Other community-related factors are the cost and availability of utilities, environmental regulations, taxes (state and local, direct and indirect), and often a laundry list of enticements offered by state or local governments that can include bond issues, tax abatements, low-cost loans, grants, and worker training.

Another trend is just-in-time manufacturing techniques (see Chapter 14), which encourage suppliers to locate near their customers to reduce supplier lead times. For this reason, some U.S. firms are reconsidering decisions to locate offshore. Moreover, in light manufacturing (e.g., electronics), low-cost labor is becoming less important than nearness to markets; users of electronics components want suppliers that are close to their manufacturing facilities. One offshoot of this is the possibility that the future will see a trend toward smaller factories located close to markets. In some industries, small, automated **microfactories** with narrow product focuses will be located near major markets to reduce response time.

It is likely that advances in information technology will enhance the ability of manufacturing firms to gather, track, and distribute information that links purchasing, marketing, and distribution with design, engineering, and manufacturing. This will reduce the need for these functions to be located close together, thereby permitting a strategy of locating production facilities near major markets.

Ethical Issues. Ethical issues can arise during location searches, so it is important for companies and governments to have policies in place before that happens, and to keep ethical aspects of decisions in mind while negotiating favorable treatment. For example, governments may offer a variety of incentives to companies to locate in their area, usually to obtain promised benefits from the companies. Companies should be careful to not promise more (e.g., jobs, longevity) or less (e.g., noise, traffic) than they can reasonably expect to deliver. Similarly, government negotiators should strive for an agreement that will ultimately benefit taxpayers, and use extreme caution in negotiating long-term arrangements that risk leaving taxpayers “holding the bag.” Also at issue are behind-the-scenes payments or favors to make a decision that would otherwise not be rated as highly.

Identifying a Site

The primary considerations related to sites are land, transportation, and zoning or other restrictions.

Microfactory Small factory with a narrow product focus, located near major markets.



Jill Braaten/McGraw-Hill Education

Apple establishes its stores in key locations with above-average household income and plenty of retail traffic. This store is located on Michigan Avenue in Chicago.

Evaluation of potential sites may require consulting with engineers or architects, especially in the case of heavy manufacturing or the erection of large buildings or facilities with special requirements. Soil conditions, load factors, and drainage rates can be critical and often necessitate certain kinds of expertise in evaluation.

Because of the long-term commitment usually required, land costs may be secondary to other site-related factors, such as room for future expansion, current utility and sewer capacities—and any limitations on these that could hinder future growth—and sufficient parking space for employees and customers. In addition, for many firms, access roads for trucks or rail spurs are important.

Industrial parks may be worthy alternatives for firms involved in light manufacturing or assembly, warehouse operations, and customer service facilities. Typically, the land is already developed—power, water, and sewer hookups have been attended to, and zoning restrictions do not require special attention. On the negative side, industrial parks may place restrictions on the kinds of activities a company can conduct, which can limit options for future development of a firm's products and services, as well as the processes it may consider. Sometimes stringent regulations governing the size, shape, and architectural features of buildings limit managerial choice in these matters. Also, there may not be an adequate allowance for possible future expansion.

For firms with executives who travel frequently, the size and proximity of the airport or train station, as well as travel connections, can be important, although schedules and connections are subject to change.

Table 8.2 provides a summary of the factors that affect location decisions.

Multiple Plant Manufacturing Strategies

When companies have multiple manufacturing facilities, they can organize operations in several ways. One is to assign different product lines to different plants. Another is to assign different market areas to different plants. And a third is to assign different processes to different plants. Each strategy carries certain cost and managerial implications, as well as competitive advantages.

Level	Factors	Considerations
Regional	Location of raw materials or supplies	Proximity, modes and costs of transportation, quantity available
	Location of markets	Proximity, distribution costs, target market, trade practices/restrictions
	Labor	Availability (general and for specific skills), age distribution of workforce, work attitudes, union or nonunion, productivity, wage scales, unemployment compensation laws
Community	Quality of life	Schools, churches, shopping, housing, transportation, entertainment, recreation, cost of living
	Services	Medical, fire, and police
	Attitudes	Pro/con
	Taxes	State/local, direct and indirect
	Environmental regulations	State/local
	Utilities	Cost and availability
	Development support	Bond issues, tax abatement, low-cost loans, grants
Site	Land	Cost, degree of development required, soil characteristics and drainage, room for expansion, parking
	Transportation	Type (access roads, rail spurs, air freight)
	Environmental/legal	Zoning restrictions

TABLE 8.2
Factors affecting location decisions

Product Plant Strategy. With this strategy, entire products or product lines are produced in separate plants, and each plant usually supplies the entire domestic market. This is essentially a decentralized approach, with each plant focusing on a narrow set of requirements that entails specialization of labor, materials, and equipment along product lines. Specialization often results in economies of scale and, compared with multipurpose plants, lower operating costs. Plant locations may be widely scattered or clustered relatively close to one another.

Market Area Plant Strategy. With this strategy, plants are designed to serve a particular geographic segment of a market (e.g., the West Coast, the Northeast). Individual plants produce most if not all of a company's products and supply a limited geographical area. Although operating costs tend to be higher than those of product plants, significant savings on shipping costs for comparable products can be made. This arrangement is particularly desirable when shipping costs are high due to volume, weight, or other factors. Such arrangements have the added benefit of rapid delivery and response to local needs. This approach requires centralized coordination of decisions to add or delete plants, or to expand or downsize current plants due to changing market conditions.

Process Plant Strategy. With this strategy, different plants concentrate on different aspects of a process. Automobile manufacturers often use this approach, with different plants for engines, transmissions, body stamping, and even radiators. This approach is best suited to products that have numerous components; separating the production of components results in less confusion than if all production were carried out at the same location.

When an organization uses process plants, coordination of production throughout the system becomes a major issue and requires a highly informed, centralized administration to achieve effective operation. A key benefit is that individual plants are highly specialized and generate volumes that yield economies of scale. However, this approach usually involves additional shipping costs.

General-Purpose Plant Strategy. With this strategy, plants are flexible and capable of handling a range of products. This allows for quick response to product or market changes, although it can be less productive than a more focused approach.

Multiple plants have an additional benefit: the increase in learning opportunities that occurs when similar operations are being done in different plants. Similar problems tend to arise, and solutions to those problems, as well as improvements in general in products and processes, made at one plant can be shared with other plants.

Geographic Information Systems

Geographic information system (GIS) A computer-based tool for collecting, storing, retrieving, and displaying demographic data on maps.

A **geographic information system (GIS)** is a computer-based tool for collecting, storing, retrieving, and displaying demographic data on maps. A GIS relies on an integrated system of computer hardware, software, data, and trained personnel to make available a wide range of geographically referenced information. Internet mapping programs used to obtain travel directions are an example of a GIS.

Many countries have an abundance of GIS data that can be accessed. For location analysis, a GIS makes it relatively easy to obtain detailed information on factors such as population density, age, incomes, ethnicity, traffic patterns, competitor locations, educational institutions, shopping centers, crime statistics, transportation resources, utilities, recreational facilities, maps and images, and a wealth of other information associated with a given location. Local governments use a GIS to organize, analyze, plan, and communicate information about community resources. And job seekers can use GISes for their searches.

The following are some ways businesses use geographic information systems:

- **Logistics companies** use GIS data to plan fleet activities such as routes and schedules based on the locations of their customers.
- **Publishers** of magazines and newspapers use a GIS to analyze circulation and attract advertisers.

- **Real estate** companies rely heavily on a GIS to make maps available online to prospective home and business buyers.
- **Banks** use a GIS to help decide where to locate branch banks and to understand the composition and needs of different market segments.
- **Insurance companies** use a GIS to determine premiums based on population distribution, crime figures, and the likelihood of natural disasters, such as flooding in various locations, and to manage risk.
- **Retailers** are able to link information about sales, customers, and demographics to geographic locations in planning locations. They also use a GIS to develop marketing strategies and for customer mapping, site selection, sales projections, promotions, and other store portfolio management applications.
- **Utility companies** use a GIS to balance supply and demand, and identify problem areas.
- **Emergency services** use a GIS to allocate resources to locations to provide adequate coverage where they are needed.

8.6 SERVICE AND RETAIL LOCATIONS

Service and retail are typically governed by somewhat different considerations than manufacturing organizations in making location decisions. For one thing, nearness to raw materials is usually not a factor, nor is concern about processing requirements. Customer access is sometimes a prime consideration, as it is with banks and supermarkets, but not a consideration in others, such as call centers, catalog sales, and online services. Manufacturers tend to be cost-focused, concerned with labor, energy, and material costs and availability, as well as distribution costs. Service and retail businesses tend to be profit or revenue focused, concerned with demographics such as age, income, and education, population/drawing area, competition, traffic volume/patterns, and customer access/parking.

Retail sales and services are usually found near the center of the markets they serve. Examples include fast-food restaurants, service stations, dry cleaners, and supermarkets. Quite often, their products and those of their competitors are so similar that they rely on convenience to attract customers. Hence, these businesses seek locations with high population densities or high traffic. The competition/convenience factor is also important in locating banks, hotels and motels, auto repair shops, drugstores, newspaper kiosks, and shopping centers. Similarly, doctors, dentists, lawyers, barbers, and beauticians typically serve clients who reside within a limited area.

Retail and service organizations typically place traffic volume and convenience high on the list of important factors. Specific types of retail or service businesses may pay more attention to certain factors due to the nature of their business or their customers. If a business is unique, and has its own drawing power, nearness to competitors may not be a factor. However, retail businesses generally prefer locations that are near other retailers because of the higher traffic volumes and convenience to customers. For example, automobile dealerships often tend to locate near each other, and restaurants and specialty stores often locate in and around malls. When businesses locate near similar businesses, it is referred to as **clustering**.

Medical services are often located near hospitals for the convenience of patients. Doctors' offices may be located near hospitals, or grouped in other, centralized areas with other doctors' offices. Available public transportation is often a consideration.

Good transportation and/or parking facilities can be vital to retail establishments. Downtown areas have a competitive disadvantage in attracting shoppers compared to malls because malls offer ample free parking and nearness to residential areas.

Customer safety and security can be key factors, particularly in urban settings, for all types of services that involve customers coming to the service location (as opposed, say, to in-home services such as home repair and rug cleaning).

LO8.6 Describe some of the key factors that guide service and retail decisions.

Clustering Similar types of businesses locate near each other.

TABLE 8.3

A comparison of service/retail considerations and manufacturing considerations

Source: Kerry Pipes, Franchising.com

Manufacturing/Distribution	Service/Retail
Cost focus	Revenue focus
Transportation modes/costs	Demographics: age, income, education
Energy availability/costs	Population/drawing area
Labor cost/availability/skills	Competition
Building/leasing costs	Traffic volume/patterns
	Customer access/parking

Many retail firms have multiple outlets (locations). Among the questions that should be considered in such cases are the following:

- How can sales, market share, and profit be optimized for the entire set of locations? Solutions might include some combination of upgrading facilities, expanding some sites, adding new outlets, and closing or changing the locations of some outlets.
- What are the potential sales to be realized from each potential solution?
- Where should outlets be located to maximize market share, sales, and profits without negatively impacting other outlets? This can be a key cause of friction between the operator of a franchise store and the franchising company.
- What probable effects would there be on market share, sales, and profits if a competitor located nearby?

A recent trend for online retailers is to locate warehouses close to the market to facilitate rapid deliveries. This is especially true for apparel ordered online.

Table 8.3 briefly compares service/retail site selection criteria with manufacturing criteria.

LO8.7 Use the techniques presented to evaluate location alternatives.

8.7 EVALUATING LOCATION ALTERNATIVES

A number of techniques are helpful in evaluating location alternatives, such as locational cost-profit-volume analysis, factor rating, and the center-of-gravity method.

Locational Cost-Profit-Volume Analysis

The economic comparison of location alternatives is facilitated by the use of cost-profit-volume analysis. The analysis can be done numerically or graphically. The graphical approach will be demonstrated here because it enhances understanding of the concept and indicates the ranges over which one of the alternatives is superior to the others.

The procedure for **locational cost-profit-volume analysis** involves these steps:

1. Determine the fixed and variable costs associated with each location alternative.
2. Plot the total-cost lines for all location alternatives on the same graph.
3. Determine which location will have the lowest total cost for the expected level of output. Alternatively, determine which location will have the highest profit.

This method assumes the following:

- Fixed costs are constant for the range of probable output.
- Variable costs are linear for the range of probable output.
- The required level of output can be closely estimated.
- Only one product is involved.

Locational cost-profit-volume analysis Technique for evaluating location choices in economic terms.

For a cost analysis, compute the total cost for each location:

$$\text{Total cost} = FC + v \times Q \tag{8-1}$$

where

FC = Fixed cost

v = Variable cost per unit

Q = Quantity or volume of output

Finding the Lowest-Cost Range for Multiple Alternatives

Fixed and variable costs for four potential plant locations are shown as follows.

EXAMPLE 1

excel
mhhe.com/stevenson14e

Location	Fixed Cost per Year	Variable Cost per Unit
A	\$250,000	\$11
B	100,000	30
C	150,000	20
D	200,000	35

- Plot the total-cost lines for these locations on a single graph.
- Identify the range of output for which each alternative is superior (i.e., has the lowest total cost).
- If expected output at the selected location is to be 8,000 units per year, which location would provide the lowest total cost?

- To plot the total-cost lines, select an output that is approximately equal to the expected output level (e.g., 10,000 units per year). Compute the total cost for each location at that level:

SOLUTION

	Fixed Cost	+	Variable Cost	=	Total Cost
A	\$250,000	+	\$11(10,000)	=	\$360,000
B	100,000	+	30(10,000)	=	400,000
C	150,000	+	20(10,000)	=	350,000
D	200,000	+	35(10,000)	=	550,000

Plot each location's fixed cost (at Output = 0) and the total cost at 10,000 units, and then connect the two points with a straight line. (See the accompanying graph.)

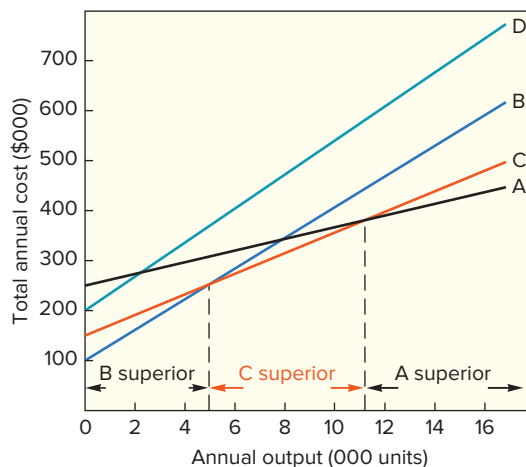

- b. The *approximate* ranges for which the various alternatives will yield the lowest costs are shown on the graph. Note that location D is never superior. The *exact* ranges can be determined by finding the output level at which lines B and C and lines C and A cross. To do this, set their total cost equations equal and solve for Q , the break-even output level. Thus, for B and C:

$$\begin{array}{r} \text{(B)} \\ \$100,000 + \$30Q = \$150,000 + \$20Q \end{array} \qquad \begin{array}{r} \text{(C)} \\ \$150,000 + \$20Q = \$250,000 + \$11Q \end{array}$$

Solving, you find $Q = 5,000$ units per year.

For C and A:

$$\begin{array}{r} \text{(C)} \\ \$150,000 + \$20Q = \$250,000 + \$11Q \end{array} \qquad \begin{array}{r} \text{(A)} \\ \$250,000 + \$11Q = \$100,000 + \$40Q \end{array}$$

Solving, $Q = 11,111$ units per year.

- c. From the graph, you can see that for 8,000 units per year, location C provides the lowest total cost.

For a profit analysis, compute the total profit for each location:

$$\text{Total profit} = Q(R - v) - FC \qquad (8-2)$$

where

R = Revenue per unit

Solved Problem 2 at the end of the chapter illustrates profit analysis.

Where the expected level of output is close to the middle of the range over which one alternative is superior, the choice is readily apparent. If the expected level of output is very close to the edge of a range, it means the two alternatives will yield comparable annual costs, so management would be indifferent in choosing between the two *in terms of total cost*. However, it is important to recognize that, in most situations, other factors besides cost must also be considered. Later in this section, a general scheme for including a broad range of factors is described. First, let's look at another kind of cost often considered in location decisions: transportation costs.

The Transportation Model

Transportation costs sometimes play an important role in location decisions. These can stem from the movement of either raw materials or finished goods. If a facility will be the sole source or destination of shipments, the company can include the transportation costs in a locational cost–volume analysis by incorporating the transportation cost per unit being shipped into the variable cost per unit. (If raw materials are involved, the transportation cost must be converted into cost per unit of *output* in order to correspond to other variable costs.)

When a problem involves the shipment of goods from multiple sending points to multiple receiving points, and a new location (sending or receiving point) is to be added to the system, the company should undertake a separate analysis of transportation. In such instances the *transportation model* of linear programming is very helpful. It is a special-purpose algorithm used to determine the minimum transportation cost that would result if a potential new location were to be added to an existing system. It also can be used if a *number* of new facilities are to be added or if an entire new system is being developed. The model is used to analyze each of the configurations considered, and it reveals the minimum costs each would provide. This information can then be included in the evaluation of location alternatives. Solved Problem 1 illustrates how the results of a transportation analysis can be combined with the results of a locational cost–volume analysis.

The website for this book contains a module that provides complete coverage of the transportation model, including methods such as northwest corner, steppingstone, and Vogel's approximation method.

Factor Rating

Factor rating is a technique that can be applied to a wide range of decisions ranging from personal (buying a car, deciding where to live) to professional (choosing a career, choosing among job offers). Here it is used for location analysis.

A typical location decision involves both qualitative and quantitative inputs, which tend to vary from situation to situation depending on the needs of each organization. **Factor rating** is a general approach that is useful for evaluating a given alternative and comparing alternatives. The value of factor rating is that it provides a rational basis for evaluation and facilitates comparison among alternatives by establishing a *composite* value for each alternative that summarizes all related factors. Factor rating enables decision makers to incorporate their personal opinions and quantitative information in the decision process.

The following procedure is used to develop a factor rating:

1. Determine which factors are relevant (e.g., location of market, water supply, parking facilities, revenue potential).
2. Assign a weight to each factor that indicates its relative importance compared with all other factors.
3. Decide on a common scale for all factors (e.g., 1 to 100), and set a minimum acceptable score if necessary. Note that an undesirable factor such as a high crime rate could be assigned a negative score. Conversely, lack of crime could be assigned a high score while a high crime rate could be assigned a low score.
4. Score each location alternative.
5. Multiply the factor weight by the score for each factor, and sum the results for each location alternative.
6. Choose the alternative that has the highest composite score, unless it fails to meet the minimum acceptable score.

This procedure is illustrated in Example 2.

Factor rating General approach to evaluating locations that includes quantitative and qualitative inputs.

Using Factor Rating to Compare Alternatives

A coffee shop owner wants to add a new location. A photo-processing company intends to open a new branch store. The following table contains information on two potential locations. Which is the better alternative?

Factor	Weight	Scores (Out of 100)		Weighted Scores	
		Alt. 1	Alt. 2	Alternative 1	Alternative 2
Proximity to existing store	.10	100	60	$.10(100) = 10.0$	$.10(60) = 6.0$
Traffic volume	.05	80	80	$.05(80) = 4.0$	$.05(80) = 4.0$
Rental costs	.40	70	90	$.40(70) = 28.0$	$.40(90) = 36.0$
Size	.10	86	92	$.10(86) = 8.6$	$.10(92) = 9.2$
Layout	.20	40	70	$.20(40) = 8.0$	$.20(70) = 14.0$
Operating costs	.15	80	90	$.15(80) = 12.0$	$.15(90) = 13.5$
				<u>70.6</u>	<u>82.7</u>

Alternative 2 is better because it has the higher composite score.

In some cases, managers may prefer to establish minimum *thresholds* for composite scores. If an alternative fails to meet that minimum, they can reject it without further consideration. If none of the alternatives meets the minimum, this means that either additional alternatives must be identified and evaluated or the minimum threshold must be reevaluated.

EXAMPLE 2

eXcel
mhhe.com/stevenson14e

SOLUTION

Center-of-gravity method Method for locating a distribution center that minimizes distribution cost.

The Center-of-Gravity Method

The **center-of-gravity method** is a method to determine the location of a facility that will minimize shipping costs or travel time to various destinations. For example, community planners use the method to determine the location of fire and public safety centers, schools, community centers, and such, taking into consideration locations of hospitals, senior living centers, population density, highways, airports, and retail businesses. The goal for police and firefighters is often to minimize travel time to answer emergency calls. The center-of-gravity method is also used for location planning for distribution centers, where the goal is typically to minimize distribution costs. The method treats distribution cost as a linear function of the distance and the quantity shipped. The quantity to be shipped to each destination is assumed to be fixed (i.e., will not change over time). An acceptable variation is that quantities are allowed to change, as long as their relative amounts remain the same (e.g., seasonal variations).

The method includes the use of a map that shows the locations of destinations. The map must be accurate and drawn to scale. A coordinate system is overlaid on the map to determine relative locations. The location of the (0,0) point of the coordinate system, and its scale, is unimportant. Once the coordinate system is in place, you can determine the coordinates of each destination. (See Figure 8.1, parts A and B.)

If the quantities to be shipped to every location are *equal*, you can obtain the coordinates of the center of gravity (i.e., the location of the distribution center) by finding the average of the *x* coordinates and the average of the *y* coordinates (see Figure 8.1). These averages can be easily determined using the following formulas:

$$\bar{x} = \frac{\sum x_i}{n}$$

$$\bar{y} = \frac{\sum y_i}{n}$$
(8-3)

where

- x_i = *x* coordinate of destination *i*
- y_i = *y* coordinate of destination *i*
- n* = Number of destinations

When the number of units to be shipped is not the same for all destinations (which is usually the case), a *weighted average* must be used to determine the center of gravity, with the weights being the *quantities* to be shipped. In some cases, the number of trips can be more important than quantities, so that metric would be used instead of quantities.

FIGURE 8.1 Center-of-gravity method

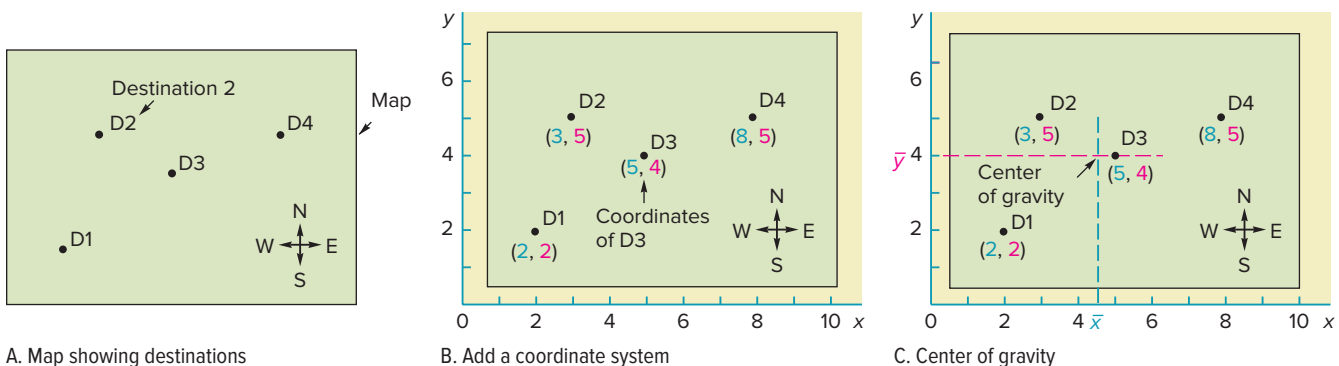

The appropriate formulas are:

$$\bar{x} = \frac{\sum x_i Q_i}{\sum Q_i} \quad (8-4)$$

$$\bar{y} = \frac{\sum y_i Q_i}{\sum Q_i}$$

where

Q_i = Quantity to be shipped to destination i

x_i = x coordinate of destination i

y_i = y coordinate of destination i

Finding the Center of Gravity

EXAMPLE 3

Determine the coordinates of the center of gravity for the problem depicted in Figure 8.1C. Assume that the shipments from the center of gravity to each of the four destinations will be equal quantities.

excel

mhhe.com/stevenson14e

The coordinates of the destinations can be obtained from Figure 8.1B:

SOLUTION

Destination	x	y
D1	2,	2
D2	3,	5
D3	5,	4
D4	8,	5
	<u>18</u>	<u>16</u>

$$\bar{x} = \frac{\sum x_i}{n} = \frac{18}{4} = 4.5 \quad \bar{y} = \frac{\sum y_i}{n} = \frac{16}{4} = 4$$

Hence, the center of gravity is at (4.5,4), which places it just west of destination D3 (see Figure 8.1C).

Finding the Center of Gravity

EXAMPLE 4

Suppose the shipments for the problem depicted in Figure 8.1A are not all equal, but instead are the following:

excel

mhhe.com/stevenson14e

Destination	x	y	Weekly Quantity
D1	2,	2	800
D2	3,	5	900
D3	5,	4	200
D4	8	5	100
			<u>2,000</u>

Determine the center of gravity.

Because the quantities to be shipped differ among destinations, you must use the weighted average formulas.

SOLUTION

$$\bar{x} = \frac{\sum x_i Q_i}{\sum Q_i} = \frac{2(800) + 3(900) + 5(200) + 8(100)}{2,000} = \frac{6,100}{2,000} = 3.05 \text{ [round to 3]}$$

$$\bar{y} = \frac{\sum y_i Q_i}{\sum Q_i} = \frac{2(800) + 5(900) + 4(200) + 5(100)}{2,000} = \frac{7,400}{2,000} = 3.7$$

Hence, the coordinates of the center of gravity are approximately (3,3.7). This would place it south of destination D2, which has coordinates of (3,5). (See Figure 8.2.)

FIGURE 8.2 Center of gravity for Example 4

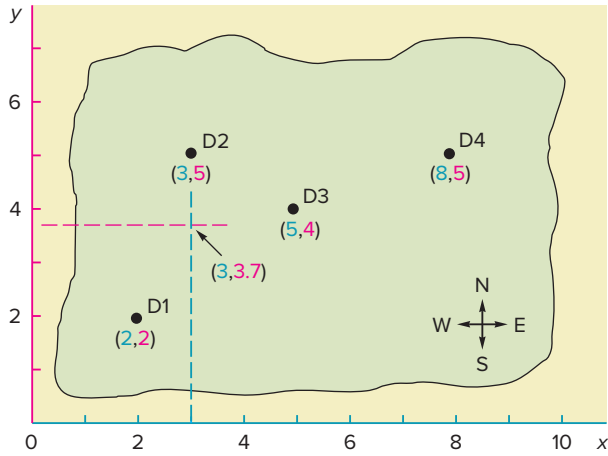
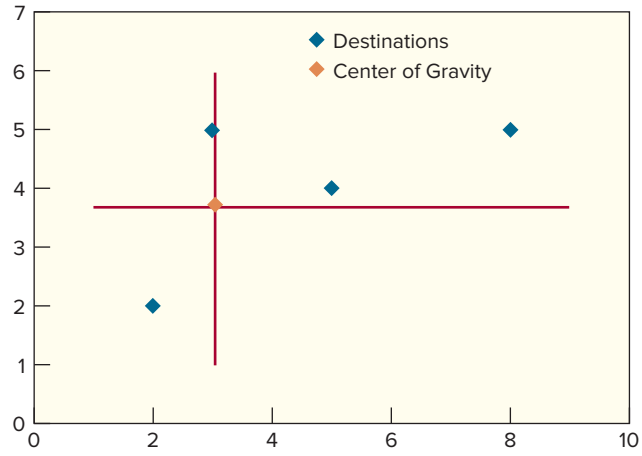

FIGURE 8.3 Solution for Example 4



See Figure 8.3 for a graph of the solution to Example 4. The problem can also be solved using the appropriate Excel template that is available on the text website.

SUMMARY

Location decisions confront both new and existing organizations. Growth, market shifts, depletion of raw materials, and the introduction of new products and services are among the reasons organizations are concerned with location decisions. The importance of these decisions is underscored by the long-term commitment they typically involve and by their potential impact on the operating system.

The primary location options available to existing organizations are to expand an existing location, move to a new location, maintain existing facilities while adding another facility in a new location, or do nothing.

In practice, the major influences on location decisions are location of raw materials, labor supply, market considerations, community-related factors, site-related factors, and climate. Foreign locations may be attractive in terms of labor costs, abundance of raw materials, or as potential markets for a firm's products or services. Problems organizations sometimes encounter in foreign countries include language differences, cultural differences, bias, and political instability.

A common approach to narrowing the range of location alternatives is to first identify a country or region that seems to satisfy overall needs and then identify a number of community-site alternatives for more in-depth analysis. A variety of methods are used to evaluate location alternatives. Those described in the chapter include locational cost-profit-volume analysis, factor rating, and the center-of-gravity method. The transportation model was mentioned briefly; your instructor can provide you with a module that covers the topic in detail.

There are numerous commercial software packages available for location analysis. In addition to the models described, many packages employ linear programming or mixed integer programming algorithms. In addition, some software packages use heuristic approaches to obtain reasonable solutions to location problems.

KEY POINTS

1. Location decisions are strategic; they can have a significant impact on the success or failure of a business.
2. Very often, location decisions are long term and involve substantial cost, so it is important to devote an appropriate amount of effort to selecting a location.
3. Decision makers must not let the attractiveness of a few factors cloud the decision-making process. There are many factors to take into account when selecting a location. It is essential to identify the key factors and their relative importance, and then use that information to evaluate location alternatives.
4. It is important to also factor in the impact that location choices will have on the supply chain.

center-of-gravity method, 368
 clustering, 363
 factor rating, 367

geographic information system (GIS), 362

locational cost-profit-volume analysis, 364
 microfactory, 360

KEY TERMS

SOLVED PROBLEMS

Cost analysis. A farm implements dealer is seeking a fourth warehouse location to complement three existing warehouses. There are three potential locations: Charlotte, NC; Atlanta, GA; and Columbia, SC. Charlotte would involve a fixed cost of \$4,000 per month and a variable cost of \$4 per unit; Atlanta would involve a fixed cost of \$3,500 per month and a variable cost of \$5 per unit; and Columbia would involve a fixed cost of \$5,000 per month and a variable cost of \$6 per unit. Use of the Charlotte location would increase system transportation costs by \$19,000 per month, Atlanta by \$22,000 per month, and Columbia by \$18,000 per month. Which location would result in the lowest total cost to handle 800 units per month?

Given: Volume = 800 units per month

	FC per Month	Variable Cost per Unit, v	Transportation Cost per Month
Charlotte	\$4,000	\$4	\$19,000
Atlanta	3,500	5	22,000
Columbia	5,000	6	18,000

Monthly total cost = FC + VC + Transportation cost

Charlotte: \$4,000 + \$4 per unit \times 800 units + \$19,000 = \$26,200

Atlanta: \$3,500 + \$5 per unit \times 800 units + \$22,000 = \$29,500

Columbia: \$5,000 + \$6 per unit \times 800 units + \$18,000 = \$27,800

Hence, Charlotte would have the lowest total cost for this monthly volume.

Problem 1

Solution

Profit analysis. A manufacturer of staplers is about to lose its lease, so it must move to another location. Two sites are currently under consideration. Fixed costs would be \$8,000 per month at site A and \$9,400 per month at site B. Variable costs are expected to be \$5 per unit at site A and \$4 per unit at site B. Monthly demand has been steady at 8,800 units for the last several years and is not expected to deviate from that amount in the foreseeable future. Assume staplers sell for \$6 per unit. Determine which location would yield the higher profit under these conditions.

Revenue - FC - v = Profit

Site	Revenue	FC	v	Monthly Profit
A	\$52,800	\$8,000	\$44,000	\$800
B	\$52,800	\$9,400	\$35,200	\$8,200

Hence, site B is expected to yield the higher monthly profit.

Problem 2

Solution

Factor rating. Determine which location has the higher factor rating given the following information.

Factor	Weight	Location Scores	
		A	B
Labor cost	5	20	40
Material cost	3	10	30
Transportation costs	2	50	10

Problem 3

Solution Combining the weights with the location scores, we can see that location B has the higher score.

Factor	Weight	Location Scores		Weighted Scores	
		A	B	A	B
Labor cost	5	20	40	5(20) = 100	5(40) = 200
Material cost	3	10	30	3(10) = 30	3(30) = 90
Transportation costs	2	50	10	2(50) = 100	2(10) = 20
Totals				230	310

Problem 4 **Center of gravity.** Determine the center of gravity location for these destinations:

Destination	x, y Coordinates	Weekly Quantity
D1	3,5	20
D2	6,8	10
D3	2,7	15
D4	4,5	15
		<u>60</u>

Solution If the weekly quantities had all been equal, we could have used the two equations in Formula 8–3 to find the center of gravity. Because the weekly quantities are not all equal, we must use the equations in Formula 8–4.

$$\bar{x} = \frac{\sum xQ}{\sum Q} = \frac{3(20) + 6(10) + 2(15) + 4(15)}{60} = \frac{210}{60} = 3.5$$

$$\bar{y} = \frac{\sum yQ}{\sum Q} = \frac{5(20) + 8(10) + 7(15) + 5(15)}{60} = \frac{360}{60} = 6.0$$

Hence, the center of gravity has the coordinates $x = 3.5$ and $y = 6$.

DISCUSSION AND REVIEW QUESTIONS

1. In what ways can the location decision have an impact on the production system?
2. Respond to this statement: “The importance of the location decision is often vastly overrated; the fact that virtually every type of business is located in every section of the country means there should be no problem in finding a suitable location.”
3. What community factors influence location decisions?
4. How are manufacturing and nonmanufacturing location decisions similar? Different?
5. What are the potential benefits of locating in foreign countries? Potential drawbacks?
6. What is factor rating, and how does it work?
7. Outline the general approach for developing location alternatives.
8. What are the basic assumptions in locational cost-profit-volume analysis?
9. Discuss recent trends in location and possible future strategies.

TAKING STOCK

1. What trade-offs are involved in deciding to have a single large, centrally located facility instead of several smaller, dispersed facilities?
2. Who needs to be involved in facility location decisions?
3. Name several ways that technology has had an impact on location decisions.

CRITICAL THINKING EXERCISES

1. A company is considering the relocation of its manufacturing plant and administrative offices from a small city in the Midwest to a similar-sized city in the South. Approximately 20 percent of the residents of the city are employed by the company, and many others are employed in businesses such as banks, personal services, restaurants, shopping centers, and supermarkets that would suffer a decline in business if the company decides to relocate. Does the company have a social responsibility to factor into its decision the impact its move would have on the city? Explain your reasoning.
2. The owner of a fast-food franchise has exclusive rights to operate in a medium-sized metropolitan area. Currently, the owner has one outlet open, which has proved very popular, often with lines of waiting customers. Thus, the owner is considering opening additional outlets in the area. What key factors should the owner investigate before making a final decision? What trade-offs would there be in opening one additional site versus opening several additional sites?
3. Corruption and bribery are common in some countries. Would you avoid locating in such a country, or locate there and deal with it? If the latter, how would you deal with it?
4. Give three examples of unethical behavior involving location selection, and indicate which ethical principle is violated (see Chapter 1).

1. A newly formed firm must decide on a plant location. There are two alternatives under consideration: locate near the major raw materials or locate near the major customers. Locating near the raw materials will result in lower fixed and variable costs compared to locating near the market, but the owners believe there would be a loss in sales volume because customers tend to favor local suppliers. Revenue per unit will be \$185 in either case. Using the following information, determine which location would produce the greater profit.

	Omaha	Kansas City
Annual fixed costs (\$ millions)	\$1.2	\$1.4
Variable cost per unit	\$36	\$47
Expected annual demand (units)	8,000	12,000

PROBLEMS

2. The owner of Genuine Subs, Inc., hopes to expand the present operation by adding one new outlet. She has studied three locations. Each would have the same labor and materials costs (food, serving containers, napkins, etc.) of \$1.76 per sandwich. Sandwiches sell for \$8 each in all locations. Rent and equipment costs would be \$5,000 per month for location A, \$5,500 per month for location B, and \$5,800 per month for location C.
 - a. Determine the volume necessary at each location to realize a monthly profit of \$10,000.
 - b. If expected sales at A, B, and C are 21,000 per month, 22,000 per month, and 23,000 per month, respectively, which location would yield the greatest profits?
3. A small producer of machine tools wants to move to a larger building, and has identified two alternatives. Location A has annual fixed costs of \$800,000 and variable costs of \$14,000 per unit; location B has annual fixed costs of \$920,000 and variable costs of \$13,000 per unit. The finished items sell for \$17,000 each.
 - a. At what volume of output would the two locations have the same total cost?
 - b. For what range of output would location A be superior? For what range would B be superior?
4. A company that produces pleasure boats has decided to expand one of its lines. Current facilities are insufficient to handle the increased workload, so the company is considering three alternatives, A (new location), B (subcontract), and C (expand existing facilities).

Alternative A would involve substantial fixed costs but relatively low variable costs: fixed costs would be \$250,000 per year, and variable costs would be \$500 per boat. Subcontracting would involve a cost per boat of \$2,500, and expansion would require an annual fixed cost of \$50,000 and a variable cost of \$1,000 per boat.

 - a. Find the range of output for each alternative that would yield the lowest total cost.
 - b. Which alternative would yield the lowest total cost for an expected annual volume of 150 boats?
 - c. What other factors might be considered in choosing between expansion and subcontracting?

5. Rework Problem 4b using this additional information: Expansion would result in an increase of \$70,000 per year in transportation costs, subcontracting would result in an increase of \$25,000 per year, and adding a new location would result in an increase of \$4,000 per year.
6. A firm that has recently experienced enormous growth is seeking to lease a small plant in Memphis, TN; Biloxi, MS; or Birmingham, AL. Prepare an economic analysis of the three locations given the following information: Annual costs for building, equipment, and administration would be \$40,000 for Memphis, \$60,000 for Biloxi, and \$100,000 for Birmingham. Labor and materials are expected to be \$8 per unit in Memphis, \$4 per unit in Biloxi, and \$5 per unit in Birmingham. The Memphis location would increase system transportation costs by \$50,000 per year, the Biloxi location by \$60,000 per year, and the Birmingham location by \$25,000 per year. Expected annual volume is 10,000 units.
7. A retired auto mechanic hopes to open a customizing shop for installing heated or ventilated seats. Two locations are being considered, one in the center of the city and one on the outskirts. The central city location would involve fixed monthly costs of \$7,000 and labor, materials, and transportation costs of \$30 per car. The outside location would have fixed monthly costs of \$4,700 and labor, materials, and transportation costs of \$40 per car. The price will be \$300 per car.
 - a. Which location will yield the greatest profit if monthly demand is 200 cars? 300 cars?
 - b. At what volume of output will the two sites yield the same monthly profit?
8. For each of the four types of organizations shown, rate the importance of each factor in terms of making location decisions using L = low importance, M = moderate importance, and H = high importance.

Factor	Local Bank	Steel Mill	Food Warehouse	Public School
Convenience for customers	_____	_____	_____	_____
Attractiveness of building	_____	_____	_____	_____
Nearness to raw materials	_____	_____	_____	_____
Large amounts of power	_____	_____	_____	_____
Pollution controls	_____	_____	_____	_____
Labor cost and availability	_____	_____	_____	_____
Transportation costs	_____	_____	_____	_____
Construction costs	_____	_____	_____	_____

9. Using the following factor ratings, determine which location alternative (A, B, or C) should be chosen on the basis of the maximum composite score.

Factor (100 points each)	Weight	Location Score		
		A	B	C
Convenience	.15	80	70	60
Parking facilities	.20	72	76	92
Display area	.18	88	90	90
Shopper traffic	.27	94	86	80
Operating costs	.10	98	90	82
Neighborhood	.10	96	85	75
	1.00			

10. Determine which location has the highest composite score:

Factor	Weight	East #1	East #2	West
Initial cost	8	100	150	140
Traffic	10	40	40	30
Maintenance	6	20	25	18
Dock space	6	25	10	12
Neighborhood	4	12	8	15

11. A manager received an analysis of several cities being considered for a new office complex. The data (10 points maximum) are as follows:

Factor	Location Score		
	A	B	C
Business services	9	5	5
Community services	7	6	7
Real estate costs	3	8	7
Construction costs	5	6	5
Cost of living	4	7	8
Taxes	5	5	4
Transportation	6	7	8

- a. If the manager weights the factors equally, how would the locations stack up in terms of their composite factor rating scores?
- b. If business services and construction costs are given weights that are double the weights of the other factors, how would the locations stack up?
12. A toy manufacturer produces toys in five locations throughout the country. Raw materials (primarily barrels of powdered plastic) will be shipped from a new, centralized warehouse whose location is to be determined. The monthly quantities to be shipped to each location are the same. A coordinate system has been established, and the coordinates of each location have been determined as shown. Determine the coordinates of the centralized warehouse.

Location	(x, y)
A	3,7
B	8,2
C	4,6
D	4,1
E	6,4

13. A clothing manufacturer produces women's clothes at four locations in Mexico. Relative locations have been determined, as shown in the table below. The location of a central shipping point for bolts of cloth must now be determined. Weekly quantities to be shipped to each location are also shown in the table. Determine the coordinates of the location that will minimize distribution costs.

Location	(x, y)	Weekly Quantity
A	5,7	15
B	6,9	20
C	3,9	25
D	9,4	30

14. A company that handles hazardous waste wants to minimize the shipping cost for shipments to a disposal center from five receiving stations it operates. Given the locations of the receiving stations and the volumes to be shipped daily, determine the location of the disposal center.

Location of Processing Station, (x, y)	Volume, Tons per Day
10,5	26
4,1	9
4,7	25
2,6	30
8,7	40

15. An analysis of sites for a distribution center has led to two possible sites (L1 and L2 on the map). The sites are comparable on every key factor. The one remaining factor is the center of gravity. Use the center of gravity method to select the better site. Monthly shipments will be the quantities listed in the table.

Destination	Quantity
D1	900
D2	300
D3	700
D4	600
D5	1,200

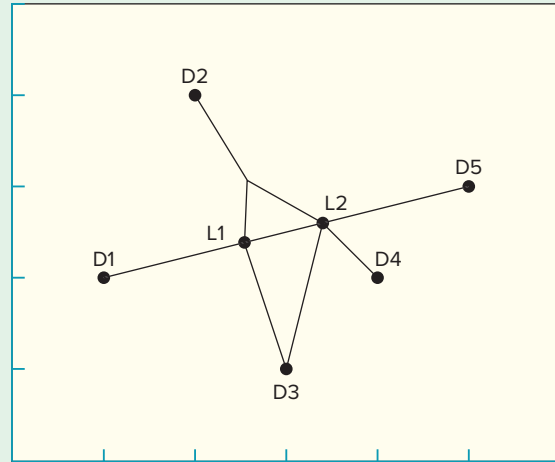



Walmart is one of the largest corporations in the world, and it has obviously enjoyed tremendous success. But while many welcome its location in their communities, others do not. Some complain that its presence has too many negative effects on a community, ranging from traffic congestion to anti-union sentiment to unfair competition.

Suppose Walmart has announced plans to seek approval from the planning commission of a small town to build a new store. Develop a list of the main arguments, pro and con, that could be

presented at a public hearing on the matter by members of each of these groups:

- Owners of small businesses located nearby
- Town residents, and residents of nearby towns

How might a Walmart representative respond to the negative criticisms that might be brought up, and what other benefits could the representative offer the planning board to bolster Walmart's case for gaining the board's approval?

Ballou, Ronald H. *Business Logistics Management*, 5th ed. Upper Saddle River, NJ: Prentice Hall, 2004.

De Meirleir, Marcel. *Location, Location, Location: A Plant Location and Site Selection Guide*. London: Routledge, 2008.

Grimshaw, David J. *Bringing Geographical Information Systems into Business*. New York: John Wiley & Sons, 2000.

Mentzer, John T. "Seven Keys to Facility Location." *Supply Chain Management Review* 12, no. 5, May 2008, p. 25.

Pick, James B. *Geo-Business: GIS in the Digital Organization*. New York: Wiley, 2008.

**SELECTED
BIBLIOGRAPHY AND
FURTHER READINGS**

9

Management of Quality

CHAPTER

LEARNING OBJECTIVES

After completing this chapter, you should be able to:

- LO9.1** Discuss the philosophies of quality gurus.
- LO9.2** Define the term *quality* as it relates to products and as it relates to services.
- LO9.3** Identify the determinants of quality.
- LO9.4** Explain why quality is important and the consequences of poor quality.
- LO9.5** Describe and give examples of the costs associated with quality.
- LO9.6** Discuss the importance of ethics in managing quality.
- LO9.7** Compare the quality awards.
- LO9.8** Discuss quality certification and its importance.
- LO9.9** Describe TQM.
- LO9.10** Give an overview of problem solving.
- LO9.11** Give an overview of process improvement.
- LO9.12** Describe the Six Sigma methodology.
- LO9.13** Describe and use various quality tools.

CHAPTER OUTLINE

- | | | |
|--|--------------------------------------|---|
| 9.1 Introduction 379 | The Determinants of Quality 386 | The European Quality Award 391 |
| 9.2 The Evolution of Quality Management 380 | Responsibility for Quality 387 | The Deming Prize 391 |
| 9.3 The Foundations of Modern Quality Management: The Gurus 381 | Benefits of Good Quality 388 | 9.6 Quality Certification 392 |
| 9.4 Insights on Quality Management 383 | The Consequences of Poor Quality 388 | ISO 9000, 14000, and 24700 392 |
| Defining Quality: The Dimensions of Quality 383 | The Costs of Quality 389 | 9.7 Quality and the Supply Chain 393 |
| Assessing Service Quality 385 | Ethics and Quality Management 390 | 9.8 Total Quality Management 394 |
| 9.5 Quality Awards 391 | The Baldrige Award 391 | Obstacles to Implementing TQM 396 |
| | | Criticisms of TQM 397 |



Thomas Samson/AFP/Getty Images

9.9 Problem Solving and Process Improvement 398

The Plan-Do-Study-Act Cycle 398
Six Sigma 400

9.10 Quality Tools 401

Illustrations of the Use of Graphical Tools 406
Methods for Generating Ideas 407

9.11 Operations Strategy 409

Cases: Chick-n-Gravy Dinner Line 414
Tip Top Markets 415

This chapter is the first of two chapters on quality. In this chapter, you will learn about the evolution of quality management, definitions of quality, the costs of quality and the consequences of poor quality, some quality awards and quality certification, total quality management, and quality tools.

The importance of quality cannot be overstated; two key elements of every purchasing decision are price and quality. Consequently, a focus on quality and quality improvement should be part of every business organization, whether the organization's business is making cars, selling electronic goods, providing financial services, providing medical services, or baking cookies.

9.1 INTRODUCTION

Broadly defined, **quality** refers to the ability of a product or service to consistently meet or exceed customer requirements or expectations. However, different customers will have different requirements, so a working definition of quality is customer-dependent.

For a decade or so, quality was an important focal point in business. But after a while, the emphasis on quality began to fade, and quality took a backseat to other concerns. However, there

Quality The ability of a product or service to consistently meet or exceed customer expectations.

has been an upsurge recently in the need for attention to quality. Much of this has been driven by recent experience with costs and adverse publicity associated with wide-ranging recalls that have included automobiles, ground meat, toys, produce, dog food, and pharmaceuticals.

9.2 THE EVOLUTION OF QUALITY MANAGEMENT

Prior to the Industrial Revolution, skilled craftsmen performed all stages of production. Pride of workmanship and reputation often provided the motivation to see that a job was done right. Lengthy guild apprenticeships caused this attitude to carry over to new workers. Moreover, one person or a small group of people were responsible for an entire product.

A division of labor accompanied the Industrial Revolution; each worker was then responsible for only a small portion of each product. Pride of workmanship became less meaningful because workers could no longer identify readily with the final product. The responsibility for quality shifted to the foremen. Inspection was either nonexistent or haphazard, although in some instances 100 percent inspection was used.

Frederick Winslow Taylor, the “Father of Scientific Management,” gave new emphasis to quality by including product inspection and gauging in his list of fundamental areas of manufacturing management. G. S. Radford improved Taylor’s methods. Two of his most significant contributions were the notions of involving quality considerations early in the product design stage and making connections among high quality, increased productivity, and lower costs.

In 1924, Bell Telephone Laboratories introduced statistical control charts that could be used to monitor production. Around 1930, H. F. Dodge and H. G. Romig, also of Bell Labs, introduced tables for sampling. Nevertheless, statistical quality control procedures were not widely used until World War II, when the U.S. government began to require vendors to use them.

World War II caused a dramatic increase in emphasis on quality control. The U.S. Army refined sampling techniques for dealing with large shipments of arms from many suppliers. By the end of the 1940s, the U.S. Army, Bell Labs, and major universities were training engineers in other industries in the use of statistical sampling techniques. About the same time, professional quality organizations were emerging throughout the country. One of these organizations was the American Society for Quality Control (ASQC, now known as ASQ). Over the years, the society has promoted quality with its publications, seminars and conferences, and training programs.

During the 1950s, the quality movement evolved into quality assurance. In the mid-1950s, total quality control efforts enlarged the realm of quality efforts from its primary focus on manufacturing to include product design and incoming raw materials. One important feature of this work was greater involvement of upper management in quality.

During the 1960s, the concept of “zero defects” gained favor. This approach focused on employee motivation and awareness, and the expectation of perfection from each employee. It evolved from the success of the Martin Company in producing a “perfect” missile for the U.S. Army.

In the 1970s, quality assurance methods gained increasing emphasis in services including government operations, health care, banking, and the travel industry.

Something else happened in the 1970s that had a global impact on quality. An embargo on oil sales instituted by the Organization of Petroleum Exporting Countries (OPEC) caused an increase in energy costs, and automobile buyers became more interested in fuel-efficient, lower-cost vehicles. Japanese auto producers, who had been improving their products, were poised to take advantage of these changes, and they captured an increased share of the automobile market. The quality of their automobiles enhanced the reputation of Japanese producers, opening the door for a wide array of Japanese-produced goods.

American producers, alarmed by their loss of market share, spent much of the late 1970s and the 1980s trying to improve the quality of their goods while lowering their costs.

The evolution of quality took a dramatic shift from quality assurance to a strategic approach to quality in the late 1970s. Up until that time, the main emphasis had been on finding and

correcting defective products before they reached the market. It was still a reactive approach. The strategic approach is proactive, focusing on preventing mistakes from occurring in the first place. The idea is to design quality into products, rather than to find and correct defects after the fact. This approach has now expanded to include processes and services. Quality and profits are more closely linked. This approach also places greater emphasis on customer satisfaction, and it involves all levels of management, as well as workers, in a continuing effort to increase quality.

9.3 THE FOUNDATIONS OF MODERN QUALITY MANAGEMENT: THE GURUS

A core of quality pioneers shaped current thinking and practice. This section describes some of their key contributions to the field.

Walter Shewhart. Walter Shewhart was a genuine pioneer in the field of quality control, and he became known as the “father of statistical quality control.” He developed control charts for analyzing the output of processes to determine when corrective action was necessary. Shewhart had a strong influence on the thinking of two other gurus, W. Edwards Deming and Joseph Juran.

W. Edwards Deming. Deming, a statistics professor at New York University in the 1940s, went to Japan after World War II to assist the Japanese in improving quality and productivity. The Union of Japanese Scientists, who had invited Deming, were so impressed that in 1951, after a series of lectures presented by Deming, they established the **Deming Prize**, which is awarded annually to firms that distinguish themselves with quality management programs and to individuals who lead such efforts.

Although the Japanese revered Deming, he was largely unknown to business leaders in the United States. In fact, he worked with the Japanese for almost 30 years before he gained recognition in his own country. Before his death in 1993, U.S. companies turned their attention to Deming, embraced his philosophy, and requested his assistance in setting up quality improvement programs.

Deming compiled a famous list of 14 points he believed were the prescription needed to achieve quality in an organization (see Table 9.1). His message was that the cause of inefficiency and poor quality is the *system*, not the employees. Deming felt that it was *management's*

1. Create constancy of purpose for improving products and services.
2. Adopt the new philosophy.
3. Cease dependence on inspection to achieve quality.
4. End the practice of awarding business on price alone; instead, minimize total cost by working with a single supplier.
5. Improve constantly and forever every process for planning, production and service.
6. Institute training on the job.
7. Adopt and institute leadership.
8. Drive out fear.
9. Break down barriers between staff areas.
10. Eliminate slogans, exhortations and targets for the workforce.
11. Eliminate numerical quotas for the workforce and numerical goals for management.
12. Remove barriers that rob people of pride of workmanship, and eliminate the annual rating or merit system.
13. Institute a vigorous program of education and self-improvement for everyone.
14. Put everybody in the company to work accomplishing the transformation.

Source: Adapted from W. Edwards Deming, *Out of the Crisis*, pp. 23 and 24. 2000. MIT Press



Richard Drew/AP Images

W. Edwards Deming.

LO9.1 Discuss the philosophies of quality gurus.

Deming Prize Prize established by the Japanese and awarded annually to firms that distinguish themselves with quality management programs.

TABLE 9.1
Deming's 14 points

responsibility to correct the system to achieve the desired results. In addition to the 14 points, Deming stressed the need to reduce variation in output (deviation from a standard), which can be accomplished by distinguishing between *special causes* of variation (i.e., correctable) and *common causes* of variation (i.e., random). Deming's concept of profound knowledge incorporates the beliefs and values about learning that guided Japan's rise to a world economic power.

Joseph M. Juran. Juran, like Deming, taught Japanese manufacturers how to improve the quality of their goods, and he, too, can be regarded as a major force in Japan's success in quality.

Juran viewed quality as fitness-for-use. He also believed that roughly 80 percent of quality defects are management controllable; thus, management has the responsibility to correct this deficiency. He described quality management in terms of a *trilogy* consisting of quality planning, quality control, and quality improvement. According to Juran, quality planning is necessary to establish processes that are *capable* of meeting quality standards; quality control is necessary in order to know when corrective action is needed; and quality improvement will help to find better ways of doing things. A key element of Juran's philosophy is the commitment of management to continual improvement.

Juran is credited as one of the first to measure the cost of quality, and he demonstrated the potential for increased profits that would result if the costs of poor quality could be reduced.

Armand Feigenbaum. Feigenbaum was instrumental in advancing the "cost of nonconformance" approach as a reason for management to commit to quality. He recognized that quality was not simply a collection of tools and techniques, but a "total field." According to Feigenbaum, it is the customer who defines quality.

Philip B. Crosby. Crosby developed the concept of *zero defects* and popularized the phrase "Do it right the first time." He stressed prevention, and he argued against the idea that "there will always be some level of defectives." The quality-is-free concept presented in his book, *Quality Is Free*, is that the costs of poor quality are much greater than traditionally defined. According to Crosby, these costs are so great that rather than viewing quality efforts as costs, organizations should view them as a way to reduce costs, because the improvements generated by quality efforts will more than pay for themselves.

Crosby believes that any level of defects is too high and that achieving quality can be relatively easy, as explained in his book *Quality Without Tears: The Art of Hassle-Free Management*.

Kaoru Ishikawa. The late Japanese expert on quality was strongly influenced by both Deming and Juran, although he made significant contributions of his own to quality management. Among his key contributions were the development of the cause-and-effect diagram (also known as a fishbone diagram) for problem solving and the implementation of quality circles, which involve workers in quality improvement. He was the first quality expert to call attention to the *internal customer*—the next person in the process, the next operation, within the organization.

Genichi Taguchi. Taguchi is best known for the Taguchi loss function, which involves a formula for determining the cost of poor quality. The idea is that the deviation of a part from a standard causes a loss, and the combined effect of deviations of all parts from their standards can be large, even though each individual deviation is small. An important part of his philosophy is the cost to society of poor quality.

Taiichi Ohno and Shigeo Shingo. Taiichi Ohno and Shigeo Shingo both developed the philosophy and methods of *kaizen*, a Japanese term for continuous improvement (defined more fully later in this chapter), at Toyota. Continuous improvement is one of the hallmarks of successful quality management.

Table 9.2 provides a summary of the important contributions of the gurus to modern quality management.

Contributor	Key Contributions
Shewhart	Control charts; variance reduction
Deming	14 points; special versus common causes of variation
Juran	Quality is fitness-for-use; quality trilogy
Feigenbaum	Quality is a total field; the customer defines quality
Crosby	Quality is free; zero defects
Ishikawa	Cause-and-effect diagrams; quality circles
Taguchi	Taguchi loss function
Ohno and Shingo	Continuous improvement

TABLE 9.2

A summary of key contributors to quality management

9.4 INSIGHTS ON QUALITY MANAGEMENT

Successful management of quality requires that managers have insights on various aspects of quality. These include defining quality in operational terms, understanding the costs and benefits of quality, recognizing the consequences of poor quality, and recognizing the need for ethical behavior. We begin with defining quality.

Defining Quality: The Dimensions of Quality

One way to think about quality is the degree to which performance of a product or service meets or exceeds customer expectations. The difference between these two, that is Performance–Expectations, is of great interest. If these two measures are equal, the difference is zero, and expectations have been met. If the difference is negative, expectations have not been met, whereas if the difference is positive, performance has exceeded customer expectations.

Customer expectations can be broken down into a number of categories, or *dimensions*, that customers use to judge the quality of a product or service. Understanding these helps organizations in their efforts to meet or exceed customer expectations. The dimensions used for goods are somewhat different from those used for services.

Product Quality. Product quality is often judged on nine dimensions of quality:¹

- Performance**—main characteristics of the product
- Aesthetics**—appearance, feel, smell, taste
- Special features**—extra characteristics
- Conformance**—how well a product corresponds to design specifications
- Reliability**—dependable performance
- Durability**—ability to perform over time
- Perceived quality**—indirect evaluation of quality (e.g., reputation)
- Serviceability**—handling of complaints or repairs
- Consistency**—quality doesn't vary

These dimensions are further described by the examples presented in Table 9.3 regarding an automobile. When referring to any product, however, a customer sometimes judges the first four dimensions by its *fitness for use*.

Notice in the table below that price is *not* a dimension of quality.

LO9.2 Define the term *quality* as it relates to products and as it relates to services.

¹Adapted from David Garvin, “Competing on the Eight Dimensions of Quality.” *Harvard Business Review* 65, no. 6 (1987). Copyright © 1987 by the Harvard Business School Publishing Corporation; all rights reserved.

TABLE 9.3

Examples of product quality for a car

Dimensions	Examples
1. Performance	Everything works: fit and finish, ride, handling, acceleration
2. Aesthetics	Exterior and interior design
3. Features	Convenience: placement of gauges High-tech: GPS system Safety: anti-skid, airbags
4. Conformance	Car matches manufacturer's specifications
5. Reliability	Infrequent need for repairs
6. Durability	Useful life in miles, resistance to rust
7. Perceived quality	Top-rated
8. Serviceability	Ease of repair
9. Consistency	Quality doesn't vary from car to car

Service Quality. The dimensions of product quality don't adequately describe service quality. Instead, service quality is often described using the following dimensions:²

Convenience—the availability and accessibility of the service

Reliability—the ability to perform a service dependably, consistently, and accurately

Responsiveness—the willingness of service providers to help customers in unusual situations and to deal with problems

Time—the speed with which service is delivered

Assurance—the knowledge exhibited by personnel who come into contact with a customer and their ability to convey trust and confidence

Courtesy—the way customers are treated by employees who come into contact with them

Tangibles—the physical appearance of facilities, equipment, personnel, and communication materials

Consistency—the ability to provide the same level of good quality repeatedly

Expectations—meet (or exceed) customer expectations

Table 9.4 illustrates how the dimensions of service quality might apply to having an automobile repaired.

TABLE 9.4

Examples of service quality dimensions for having a car repaired

Dimension	Examples
1. Convenience	Was the service center conveniently located?
2. Reliability	Was the problem fixed and will the "fix" last?
3. Responsiveness	Were customer service personnel willing and able to answer questions?
4. Time	How long did the customer have to wait?
5. Assurance	Did the customer service personnel seem knowledgeable about the repair?
6. Courtesy	Were customer service personnel and the cashier friendly and courteous?
7. Tangibles	Were the facilities clean? Were personnel neat?
8. Consistency	Was the service quality good, and was it consistent with previous visits?
9. Expectations	Were customer expectations met?

²Adapted from Valerie A. Zeithaml, A. Parasuraman, and Leonard L. Berry, *Delivering Quality Service and Balancing Customer Expectations* (New York: The Free Press, 1990); and J. R. Evans and W. M. Lindsey, *The Management and Control of Quality*, 3rd ed. (St. Paul, MN: West Publishing, 1996).

The dimensions of both product and service quality establish a *conceptual* framework for thinking about quality, but even they are too abstract to be applied operationally for purposes of product or service design, or actually producing a product or delivering a service. They must be stated in terms of specific, *measurable* characteristics. For example, when buying a car, a customer would naturally be interested in the car's performance. But what does that mean? In more specific terms, it might refer to a car's estimated miles per gallon, how quickly it can go from 0 to 60 miles per hour, or its stopping distance when traveling at 60 mph. Each of these can be stated in measurable terms (e.g., estimated miles per gallon: city = 25, highway = 30). Similar measurable characteristics can often be identified for each of the other product dimensions, as well as for the service dimensions. This is the sort of detailed information that is needed to both design and produce high-quality goods and services.

Information on customer wants in service can sometimes be difficult to pin down, creating challenges for designing and managing service quality. For example, customers may use words such as *friendly*, *considerate*, and *professional* to describe what they expect from service providers. These and similar descriptors are often difficult to translate into exact service specifications. Moreover, in many instances, customer wants are often industry specific. Thus, the expectations would be quite different for health care versus dry cleaning. Furthermore, customer complaints may be due in part to unrelated factors (e.g., customer's mood or general health, the weather).

Other challenges with service quality include the reality that customer expectations often change over time and that different customers tend to have different expectations, so what one customer might view as good service quality, another customer might not be satisfied with at all. Couple these with the fact that each contact with a customer is a "moment of truth" in which service quality is instantly judged, and you begin to understand some of the challenges of achieving a consistently high perception of service quality.

If customers participate in a service system (i.e., self-service), there can be increased potential for a negative perception of quality. Consequently, adequate care must be taken to make the necessary customer acts simple and safe, especially because customers cannot be trained. So error prevention must be designed into the system.

It should also be noted that in most instances, some quality dimensions of a product or service will be more important than others, so it is important to identify customer priorities, especially when it is likely that trade-off decisions will be made at various points in design and production. Quality function deployment (described in Chapter 4) is a tool that can be helpful for that purpose.

Assessing Service Quality

A widely used tool for assessing service quality is SERVQUAL,³ an instrument designed to obtain feedback on an organization's ability to provide quality service to customers. It focuses on five of the previously mentioned service dimensions that influence customers' perceptions of service quality: tangibles, reliability, responsiveness, assurance, and empathy. The results of this service quality audit help management identify service strengths and weaknesses. Of particular interest are any *gaps* or discrepancies in service quality. There may be discrepancies between:

- Actual customer expectations and management perceptions of those expectations
- Management perceptions of customer expectations and service-quality specifications
- Service quality and the service actually delivered
- The service actually delivered and what is communicated about the service to customers
- Customers' expectations of the service provider and their perceptions of provider delivery

If gaps are found, they can be related to tangibles or other service quality dimensions to address the discrepancies.

³Valarie A. Zeithaml, A. Parasuraman, and Leonard L. Berry, *Delivering Quality Service: Balancing Customer Perceptions and Expectations* (New York: The Free Press, 1990), p 26.



AMERICAN FAST-FOOD RESTAURANTS ARE HAVING SUCCESS IN CHINA

Chinese consumers were initially drawn to American fast-food restaurants such as Kentucky Fried Chicken (KFC) and Pizza Hut out of curiosity, but ended up liking the quality and consistency those restaurants offered compared to some local “copycat” restaurants. Trust is particularly important to many Chinese consumers, and they appreciate the strict adherence to quality provided by American fast-food restaurants. Moreover, unlike fast-food restaurants in the United States, where most service is take out, Chinese

customers view dining out as an experience to be enjoyed, so “fast food” restaurants have added more seating space to accommodate those preferences. In addition, the food offerings are more upscale than in the United States, which is more in line with consumer preferences of Chinese patrons.

Based on: Clarissa Wei, “Why China Loves American Chain Restaurants So Much.” *Eater*, March 20, 2018. <https://www.eater.com/2018/3/20/16973532/mcdonalds-starbucks-kfc-china-pizza-hut-growth-sales>

LO9.3 Identify the determinants of quality.

The Determinants of Quality

The degree to which a product or a service successfully satisfies its intended purpose has four primary determinants:

- Design
- How well the product or service conforms to the design
- Ease of use
- Service after delivery

The design phase is the starting point for the level of quality eventually achieved. Design involves decisions about the specific characteristics of a product or service such as size, shape, and location. **Quality of design** refers to the intention of designers to include or exclude certain features in a product or service. For example, many different models of automobiles are on the market today. They differ in size, appearance, roominess, fuel economy, comfort, and materials used. These differences reflect choices made by designers that determine the quality of design. Design decisions must take into account customer wants, production or service capabilities, safety and liability (both during production and after delivery), costs, and other similar considerations.

Designers may determine customer wants from information provided by marketing, perhaps through the use of consumer surveys or other market research. Marketing may organize focus groups of consumers to express their views on a product or service (what they like and don’t like, and what they would like to have).

Designers must work closely with representatives of operations to ascertain that designs can be produced; that is, that production or service has the equipment, capacity, and skills necessary to produce or provide a particular design.

A poor design can result in difficulties in production or service. For example, materials might be difficult to obtain, specifications difficult to meet, or procedures difficult to follow. Moreover, if a design is inadequate or inappropriate for the circumstances, the best workmanship in the world may not be enough to achieve the desired quality. Also, we cannot expect a worker to achieve good results if the given tools or procedures are inadequate. Similarly, a superior design usually cannot offset poor workmanship.

Quality of conformance refers to the degree to which goods and services conform to (i.e., *achieve*) the intent of the designers. This is affected by factors such as the capability of equipment used; the skills, training, and motivation of workers; the extent to which the design lends itself to production; the monitoring process to assess conformance; and the taking of corrective action (e.g., through problem solving) when necessary. One important key to quality is reducing the variability in process outputs (i.e., reducing the degree to which individual items or individual service acts vary from one another). This will be discussed in detail in Chapter 10.

The determination of quality does not stop once the product or service has been sold or delivered. *Ease of use* and user instructions are important. They increase the chances, but do

Quality of design Intention of designers to include or exclude features in a product or service.

Quality of conformance The degree to which goods or services conform to the intent of the designers.



Customers shopping for phones.

Graham Oliver/Echo/Getty Images

not guarantee, that a product will be used for its intended purposes and in such a way that it will continue to function properly and safely. (When faced with liability litigation, companies often argue that injuries and damages occurred because the user misused the product.) Much of the same reasoning can be applied to services. Customers, patients, clients, or other users must be clearly informed on what they should or should not do; otherwise, there is the danger they will take some action that will adversely affect quality. Some examples include the doctor who fails to specify that a medication should be taken *before* meals and *not* with orange juice and the attorney who neglects to inform a client of a deadline for filing a claim.

Much consumer education takes the form of printed instructions and labeling. Thus, manufacturers must ensure that directions for unpacking, assembling, using, maintaining, and adjusting the product—and what to do if something goes wrong (e.g., flush eyes with water, call a physician, induce vomiting, do not induce vomiting, disconnect set immediately)—are *clearly visible* and *easily understood*.

For a variety of reasons, products do not always perform as expected, and services do not always yield the desired results. Whatever the reason, it is important from a quality standpoint to remedy the situation—through recall and repair of the product, adjustment, replacement or buyback, or reevaluation of a service—and do whatever is necessary to bring the product or service up to standard.

Responsibility for Quality

It is true that all members of an organization are in some way responsible for quality, but certain parts of an organization have key areas of responsibility:

Top management. Top management is ultimately responsible for quality. While establishing strategies for quality, top management must institute programs to improve quality; guide, direct, and motivate managers and workers; and set an example by being involved in quality initiatives. Examples include taking training in quality, issuing periodic reports on quality, and attending meetings on quality.

Design. Quality products and services begin with design. This includes not only features of the product or service, it also includes attention to the *processes* that will be required to produce the products and/or services necessary to deliver the service to customers.

Procurement. The procurement department is responsible for obtaining goods and services that will not detract from the quality of the organization's goods and services.

Production/operations. Production/operations is responsible for ensuring that processes yield products and services that conform to design specifications. Monitoring processes and finding and correcting root causes of problems are important aspects of this responsibility.

Quality assurance. Quality assurance is responsible for gathering and analyzing data on problems and working with operations to solve problems.

Packaging and shipping. This department must ensure that goods are not damaged in transit, that packages are clearly labeled, that instructions are included, that all parts are included, and that shipping occurs in a timely manner.

Marketing and sales. This department is responsible for determining customers' needs and communicating them to appropriate areas of the organization. In addition, it must report any problems with products or services to the company.

Customer service. Customer service is often the first department to learn of problems. It is responsible for communicating that information to appropriate departments, dealing in a reasonable manner with customers, working to resolve problems, and following up to confirm that the situation has been effectively remedied.

Poor quality increases certain *costs* incurred by the organization. The following section provides further detail on costs associated with quality.

LO9.4 Explain why quality is important and the consequences of poor quality.

Benefits of Good Quality

Business organizations with good or excellent quality typically benefit in a variety of ways: an enhanced reputation for quality, the ability to command premium prices, an increased market share, greater customer loyalty, lower liability costs, and fewer production or service problems—which yields higher productivity, fewer complaints from customers, lower production costs, and higher profits. Annual studies by the National Institute of Standards indicate that winners of the Malcolm Baldrige National Quality Award, described later in this chapter, outperform the S&P 500 Index by a significant amount.⁴

The Consequences of Poor Quality

It is important for management to recognize the different ways in which the quality of a firm's products or services can affect the organization, and to take these into account in developing and maintaining a quality assurance program. Some of the major areas affected by quality are:

- Loss of business
- Liability
- Productivity
- Costs

Poor designs or defective products or services can result in *loss of business*. Failure to devote adequate attention to quality can damage a profit-oriented organization's reputation and lead to a decreased share of the market, or it can lead to increased criticism and/or controls for a government agency or nonprofit organization.

In the retail sector, managers might not be fully aware of poor product or service quality because customers do not always report their dissatisfaction. Even so, dissatisfied customers do tend to voice their dissatisfaction, especially on social media, which can have negative implications for customer perceptions and future business.

Organizations must pay special attention to their potential *liability* due to damages or injuries resulting from either faulty design or poor workmanship. This applies to both products and services. Thus, a poorly designed steering arm on a car might cause the driver to lose control

⁴"Baldrige Index Outperforms S&P 500 by Almost 5 to 1," press release, available at www.quality.nist.gov.



When Hyundai Motor Company set out to improve the quality of its cars to the level of Toyota vehicles, many doubted that claim. Not only did the company accomplish that, it exceeded that goal by topping Toyota's vehicles in several categories in various customer surveys. That may have inspired the company to introduce its luxury brand, Genesis.

Hyundai has one of the longest warranties of any automobile manufacturer, underlying its commitment to quality. The company's focus on quality was a direct result of the company's chairman's attention to the goal, adding more workers to the quality team, supporting their efforts with needed resources, and holding frequent meetings with quality team members to compare Hyundai quality with rival carmakers' quality.

of the car, but so could improper assembly of the steering arm. Whatever the cause, the net result is the same. Similarly, a tree surgeon might be called to cable a tree limb. If the limb later falls and causes damage to a neighbor's car, the accident might be traced to a poorly designed procedure for cabling or to improper workmanship. Liability for poor quality has been well established in the courts. An organization's liability costs can often be substantial, especially if large numbers of items are involved, as in the automobile industry, or if potentially widespread injury or damage is involved (e.g., an accident at a nuclear power plant). Express written warranties, as well as implied warranties, generally guarantee the product as safe when used as intended. The courts have tended to extend this to *foreseeable* uses, even if these uses were not intended by the producer. In the health care field, medical malpractice claims and insurance costs are contributing to skyrocketing costs and have become a major issue nationwide. It's been estimated that medical mistakes result in about 98,000 deaths annually in the United States. Surprisingly, this number has remained fairly steady for more than a few years. If medical errors were classified as a disease, they would rank about sixth on the list of major causes of death.

Productivity and quality are often closely related. Poor quality can adversely affect productivity during the manufacturing process if parts are defective and have to be reworked, or if an assembler has to try a number of parts before finding one that fits properly. Also, poor quality in tools and equipment can lead to injuries and defective output, which must be reworked or scrapped, thereby reducing the amount of usable output for a given amount of input. Similarly, poor service can mean having to redo the service and reduce service productivity.

The cost to remedy a problem is a major consideration in quality management. The earlier a problem is identified in the process, the cheaper the cost to fix it. The cost to fix a problem at the customer end has been estimated to be about five times the cost to fix a problem at the design or production stages.

The Costs of Quality

Any serious attempt to deal with quality issues must take into account the costs associated with quality. Those costs can be classified into four categories: appraisal, prevention, internal failures, and external failures. The first three reflect costs incurred *before* customers receive the product (or sometimes the service), while the last occurs *after* customers receive the product or service. These costs are explained in the following paragraphs, and summarized in Table 9.5.

Appraisal costs relate to inspection, testing, and other activities intended to uncover defective products or services, or to assure that there are none. They include the cost of inspectors, testing, test equipment, labs, quality audits, and field testing.

Prevention costs relate to attempts to prevent defects from occurring. They include costs such as planning and administration systems, working with vendors, training, quality control procedures, and extra attention in both the design and production phases to decrease the probability of defective workmanship.

Failure costs are incurred by defective parts or products, or by faulty services. **Internal failures** are those discovered during the production process, whereas **external failures** are those discovered after delivery to the customer. Internal failures occur for a variety of reasons, including defective material from vendors, incorrect machine settings, faulty equipment, incorrect methods, incorrect processing, carelessness, and faulty or improper

LO9.5 Describe and give examples of the costs associated with quality.

Appraisal costs Costs of activities designed to ensure quality or uncover defects.

Prevention costs Costs of preventing defects from occurring.

Failure costs Costs caused by defective parts or products or by faulty services.

Internal failures Failures discovered during production.

External failures Failures discovered after delivery to the customer.

TABLE 9.5
Summary of quality costs

Category	Description	Examples
Appraisal costs	Costs related to measuring, evaluating, and auditing materials, parts, products, and services to assess conformance with quality standards	Inspection equipment, testing, labs, inspectors, and the interruption of production to take samples
Prevention costs	Costs related to reducing the potential for quality problems	Quality improvement programs, training, monitoring, data collection and analysis, and design costs
Internal failure costs	Costs related to defective products or services before they are delivered to customers	Rework costs, problem solving, material and product losses, scrap, and downtime
External failure costs	Costs related to delivering substandard products or services to customers	Returned goods, reworking costs, warranty costs, loss of goodwill, liability claims, and penalties

material handling procedures. The costs of internal failures include lost production time, scrap and rework, investigation costs, possible equipment damage, and possible employee injury. Rework costs involve the salaries of workers and the additional resources needed to perform the rework (e.g., equipment, energy, raw materials). Beyond those costs are items such as inspection of reworked parts, disruption of schedules, the added costs of parts and materials in inventory waiting for reworked parts, and the paperwork needed to keep track of the items until they can be reintegrated into the process. External failures are defective products or poor service that go undetected by the producer. Resulting costs include warranty work, handling of complaints, replacements, liability/litigation, payments to customers or discounts used to offset the inferior quality, loss of customer goodwill, and opportunity costs related to lost sales.

External failure costs are typically much greater than internal failure costs on a per-unit basis. Table 9.5 summarizes quality costs.

Internal and external failure costs represent costs related to poor quality, whereas appraisal and prevention costs represent investments for achieving good quality.

An important issue in quality management is the value received from expenditures on prevention. There are two schools of thought on this. One is that prevention costs will be outweighed by savings in appraisal and failure costs. This is espoused by such people as Crosby and Juran, who are discussed in further detail later in this chapter. They believe that as the costs of defect prevention are increased, the costs of appraisal and failure decrease by much more. What this means, if true, is that the net result is lower total costs, and, thus, as Crosby suggests, quality is free. On the other hand, some managers believe that by attempting to go beyond a certain point, such expenditures on quality reduce the funds available for other objectives, such as reducing product development times and upgrading technology. The **return on quality (ROQ)** approach focuses on the economics of quality efforts. In this approach, quality improvement projects are viewed as investments, and as such, they are evaluated like any other investment, using metrics related to return on investment (ROI).

Return on quality An approach that evaluates the financial return of investments in quality.

LO9.6 Discuss the importance of ethics in managing quality.

Ethics and Quality Management

All members of an organization have an obligation to perform their duties in an ethical manner. Ethical behavior comes into play in many situations that involve quality. One major category is substandard work, including defective products and substandard service, poor designs, shoddy workmanship, and substandard parts and raw materials. Having knowledge of this and failing to correct and *report it* in a timely manner is unethical and can have a number of negative consequences. These can include increased costs for organizations in terms of decreased productivity, an increase in the accident rate among employees, inconveniences and injuries to customers, and increased liability costs.

A related issue is how an organization chooses to deal with information about quality problems in products that are already in service. For example, automakers and tire makers in

recent years have been accused of withholding information about actual or potential quality problems. They failed to issue product recalls, or failed to divulge information, choosing instead to handle any complaints that arose on an individual basis.

9.5 QUALITY AND PERFORMANCE EXCELLENCE AWARDS

In the late 1980s and 1990s, quality awards were established to generate improvement in quality. The Malcolm Baldrige National Quality Award and the European Quality Award, given annually to organizations in all sectors of the economy, have evolved from an early focus on quality management to a focus on overall organizational excellence. The Deming Prize recognizes firms that have integrated quality management into their operations.

The Baldrige Award

Named after the late Malcolm Baldrige, an industrialist and former secretary of commerce, the annual **Baldrige Award** is administered by the Baldrige Performance Excellence Program at the National Institute of Standards and Technology. The purpose of the award is to identify and recognize role-model organizations, establish criteria for evaluating improvement efforts (known as the Baldrige Excellence Framework), and disseminate and share best practices.

When the award was first presented in 1988, the award categories were manufacturing and small business. A few years later, a service category was added. Categories for education, health care, and nonprofit/government organizations were subsequently added. The earliest winners included Motorola, Globe Metallurgical, Xerox Corporation, and Milliken & Company. Since then, many organizations have been added to the list. For a complete listing of current and former winners, go to www.nist.gov/baldrige/award-recipient.

As the drivers of long-term success have evolved, so, too, have the award and the Baldrige Excellence Framework. Today, the Baldrige Award recognizes U.S. organizations that are role models for organization-wide excellence. Applicants' approaches are evaluated in seven main areas: leadership; strategy; customers; measurement, analysis, and knowledge management; workforce; operations; and results.

Examiners check the extent to which organizations ensure continuous improvement in overall performance in delivering products and/or services, and provide an approach for satisfying and responding to customers and stakeholders. They examine results in five key areas: product and process outcomes, customer outcomes, workforce outcomes, leadership and governance outcomes, and financial and market outcomes. Even organizations that don't receive the award benefit from applying: All applicants receive a written summary of strengths and opportunities for improvement in their processes and results.

Most states are served by performance excellence programs (under the umbrella of the Alliance for Performance Excellence, www.baldrigealliance.org) based on the Baldrige Framework. These award programs can serve as an entry point for organizations that want to improve their performance or eventually apply for the national award.

For more information, visit www.nist.gov/baldrige.

The European Quality Award

The **European Quality Award** is Europe's most prestigious award for organizational excellence. The European Quality Award sits at the top of regional and national quality awards, and applicants have often won one or more of those awards prior to applying for the European Quality Award.

The Deming Prize

The Deming Prize, named in honor of the late W. Edwards Deming, is Japan's highly coveted award recognizing successful quality efforts. It is given annually to any company that meets the award's standards. Although often given to Japanese companies, companies in other countries have also received the award. The award is also given to individuals.

Baldrige Award Annual award given by the U.S. government to recognize quality achievements of U.S. companies.



Source: Crystal Manufactured by Pelucida Glass LLC

LO9.7 Compare the quality awards.

European Quality Award European award for organizational excellence.

The major focus of the judging is on statistical quality control, making it much narrower in scope than the Baldrige Award, which focuses more on customer satisfaction. Companies that win the Deming Prize tend to have quality programs that are detailed and well-communicated throughout the company. Their quality improvement programs also reflect the involvement of senior management and employees, customer satisfaction, and training.

L09.8 Discuss quality certification and its importance.

ISO 9000 A set of international standards on quality management and quality assurance, critical to international business.

ISO 14000 A set of international standards for assessing a company's environmental performance.

9.6 QUALITY CERTIFICATION

Many firms that do business internationally recognize the importance of quality certification.

ISO 9000, 14000, and 24700

The International Organization for Standardization (ISO) promotes worldwide standards for the improvement of quality, productivity, and operating efficiency through a series of standards and guidelines. Used by industrial and business organizations, regulatory agencies, governments, and trade organizations, the standards have important economic and social benefits. Not only are they tremendously important for designers, manufacturers, suppliers, service providers, and customers, but the standards make a tremendous contribution to society in general: They increase the levels of quality and reliability, productivity, and safety, while making products and services affordable. The standards help facilitate international trade. They provide governments with a basis for health, safety, and environmental legislation. And they aid in transferring technology to developing countries.

Two of the most well-known of these are ISO 9000 and ISO 14000. **ISO 9000** pertains to quality management. It concerns what an organization does to ensure its products or services conform to its customers' requirements. **ISO 14000** concerns what an organization does to minimize harmful effects to the environment caused by its operations. Both ISO 9000 and ISO 14000 relate to an organization's *processes* rather than its products and services, and both stress continual improvement. Moreover, the standards are meant to be generic; no matter what the organization's business, if it wants to establish a quality management system or an environmental management system, the system must have the essential elements contained in ISO 9000 or in ISO 14000. The ISO 9000 standards are critical for companies doing business internationally, particularly in Europe. They must go through a process that involves documenting quality procedures and on-site assessment. The process often takes 12 to 18 months. With certification comes *registration* in an ISO directory that companies seeking suppliers can refer to for a list of certified companies. They are generally given preference over unregistered companies. More than 40,000 companies are registered worldwide, and three-fourths of them are located in Europe.

A key requirement for registration is that a company review, refine, and map functions such as process control, inspection, purchasing, training, packaging, and delivery. Similar to the Baldrige Award, the review process involves considerable self-appraisal, resulting in problem identification and improvement. Unlike the Baldrige Award, registered companies face an ongoing series of audits, and they must be re-registered every three years.

In addition to the obvious benefits of certification for companies that want to deal with the European Union, the ISO 9000 certification and registration process is particularly helpful for companies that do not currently have a quality management system. It provides guidelines for establishing the system and making it effective.

Eight quality management principles form the basis of the latest version of ISO 9000:

1. A customer focus
2. Leadership
3. Involvement of people
4. A process approach
5. A system approach to management
6. Continual improvement
7. Use of a factual approach to decision making
8. Mutually beneficial supplier relationships

The standards for ISO 14000 certification bear upon three major areas:

Management systems—systems development and integration of environmental responsibilities into business planning

Operations—consumption of natural resources and energy

Environmental systems—measuring, assessing, and managing emissions, effluents, and other waste streams

ISO 24700 pertains to the quality and performance of office equipment that contains reused components. ISO/IEC 24700 specifies product characteristics for use in an original equipment manufacturer's or authorized third-party's declaration of conformity to demonstrate that a marketed product that contains reused components performs equivalent to being new, meeting equivalent-to-new component specifications and performance criteria, and continues to meet all the safety and environmental criteria required by responsibly built products. It is relevant to marketed products whose manufacturing and recovery processes result in the reuse of components.

If you'd like to learn more about ISO standards, visit the International Organization for Standardization website at www.ISO.org/ISO/en/ISOonline.frontpage or the American Society for Quality website at www.asq.org.

ISO 24700 A set of international standards that pertains to the quality and performance of office equipment that contains reused components.

9.7 QUALITY AND THE SUPPLY CHAIN

Business leaders are increasingly recognizing the importance of their supply chains in achieving their quality goals. Achievement requires measuring customer perceptions of quality, identifying problem areas, and correcting those problems.

When dealing with supplier quality in global supply chains, companies are finding a wide range in the degree of sophistication concerning quality assurance. Although developed countries often have a fair level of sophistication, little or no awareness of modern quality practices may be found in some less-developed countries. This poses important liability issues for companies that outsource to those areas.

An interesting situation is outsourcing in the pharmaceutical industry. Offshore suppliers offer low prices that domestic producers can't match. However, the cost advantage of offshore producers is not based solely on lower labor costs; a significant "advantage" is the fact



Chip Somodevilla/Getty Images

The acting chair of the Consumer Product Safety Commission spoke at a press conference on a recall of Mattel Inc. toys manufactured in China. Mattel recalled 18.6 million products around the world because they contained magnets that could fall out and be swallowed by children.

that domestic producers undergo strict and costly government quality regulations and unannounced inspections that offshore producers are not subject to. While this lowers the costs to importers, it also increases their liability risks.

Increasingly, the emphasis in supply chain quality management is on reducing outsourcing risk, as well as product or service variation and overhead. Risk comes from the use of substandard materials or work methods, which can lead to inferior product quality and potential product liability. Tighter control of vendors and worker training can reduce these risks. Variation results from processes that are not in control; it can be reduced through statistical quality control. Overhead can be reduced by assigning quality assurance responsibility to vendors, while customers operate in a quality audit mode, with some monitoring of vendor quality efforts.

Supply chain quality management can benefit from a collaborative relationship with suppliers that includes helping suppliers with quality assurance efforts, as well as information sharing on quality-related matters. Ideally, improving supply chain quality can become part of an organization's continuous improvement efforts.

9.8 TOTAL QUALITY MANAGEMENT

LO9.9 Describe TQM.

Total quality management (TQM) A philosophy that involves everyone in an organization in a continual effort to improve quality and achieve customer satisfaction.

Fail-safing Incorporating design elements that prevent incorrect procedures.

A primary role of management is to lead an organization in its daily operation and to maintain it as a viable entity into the future. Quality has become an important factor in both of these objectives.

The term **total quality management (TQM)** refers to a quest for quality in an organization. There are three key philosophies in this approach. One is a never-ending push to improve, which is referred to as *continuous improvement*; the second is the *involvement of everyone* in the organization; and the third is a goal of *customer satisfaction*, which means meeting or exceeding customer expectations. TQM expands the traditional view of quality—looking only at the quality of the final product or services—to *looking at the quality of every aspect of the process* that produces the product or service. TQM systems are intended to prevent poor quality from occurring.

We can describe the TQM approach as follows:

1. Find out what customers want. This might involve the use of surveys, focus groups, interviews, or some other technique that integrates the customer's voice in the decision-making process. Be sure to include the *internal customer* (the next person in the process), as well as the *external customer* (the final customer).
2. Design a product or service that will meet (or exceed) what customers want. Make it easy to use and easy to produce.
3. Design processes that facilitate doing the job right the first time. Determine where mistakes are likely to occur and try to prevent them. When mistakes do occur, find out why so they are less likely to occur again. Strive to make the process "mistake-proof." This is sometimes referred to as a **fail-safing**: Elements are incorporated in product or service design that make it virtually impossible for an employee (or sometimes a customer) to do something incorrectly. The Japanese term for this is *pokayoke*. Another term sometimes used is *mistake-proofing*. Examples include parts that fit together one way only and appliance plugs that can be inserted into a wall outlet the correct way only. A term that is sometimes used for this is *foolproofing*, but this term may be taken to imply that employees (or customers) are fools—not a wise choice!
4. Keep track of results, and use them to guide improvement in the system. Never stop trying to improve.
5. Extend these concepts throughout the supply chain.
6. Top management must be involved and committed. Otherwise, TQM will just be another fad that fails and fades away.

Many companies have successfully implemented TQM programs. Successful TQM programs are built through the dedication and combined efforts of everyone in the organization.

The preceding description provides a good idea of what TQM is all about, but it doesn't tell the whole story. A number of other elements of TQM are important:

1. **Continuous improvement.** The *philosophy* that seeks to improve all factors related to the process of converting inputs into outputs on an ongoing basis is called **continuous improvement**. It covers equipment, methods, materials, and people. Under continuous improvement, the old adage "If it ain't broke, don't fix it" gets transformed into "Just because it isn't broke doesn't mean it can't be improved."

The concept of continuous improvement was not new, but it did not receive much interest in the United States for a while, even though it originated here. However, many Japanese companies used it for years, and it became a cornerstone of the Japanese approach to production. The Japanese use the term **kaizen** to refer to continuous improvement. The successes of Japanese companies caused other companies to reexamine many of their approaches. This resulted in a strong interest in the continuous improvement approach.
2. **Competitive benchmarking.** This involves identifying other organizations that are the best at something and studying how they do it to learn how to improve your operation. The company need not be in the same line of business. For example, Xerox used the mail-order company L.L. Bean to benchmark order filling.
3. **Employee empowerment.** Giving workers the responsibility for improvements and the authority to make changes to accomplish them provides strong motivation for employees. This puts decision making into the hands of those who are closest to the job and have considerable insight into problems and solutions.
4. **Team approach.** The use of teams for problem solving and to achieve consensus takes advantage of group synergy, gets people involved, and promotes a spirit of cooperation and shared values among employees.
5. **Decisions based on facts rather than opinions.** Management gathers and analyzes data as a basis for decision making.
6. **Knowledge of tools.** Employees and managers are trained in the use of quality tools.
7. **Supplier quality.** Suppliers must be included in quality assurance and quality improvement efforts so their processes are capable of delivering quality parts and materials in a timely manner.
8. **Champion.** A TQM champion's job is to promote the value and importance of TQM principles throughout the company.
9. **Quality at the source.** **Quality at the source** refers to the philosophy of making each worker responsible for the quality of his or her work. The idea is to "Do it right the first time." Workers are expected to provide goods or services that meet specifications and to find and correct mistakes that occur. In effect, each worker becomes a quality inspector for his or her work. When the work is passed on to the next operation in the process (the internal customer) or, if that step is the last in the process, to the ultimate customer, the worker is "certifying" that it meets quality standards.

This accomplishes a number of things: (a) it places direct responsibility for quality on the person(s) who directly affect it; (b) it removes the adversarial relationship that often exists between quality control inspectors and production workers; and (c) it motivates workers by giving them control over their work, as well as pride in it.
10. **Suppliers** are partners in the process, and long-term relationships are encouraged. This gives suppliers a vital stake in providing quality goods and services. Suppliers, too, are expected to provide quality at the source, thereby reducing or eliminating the need to inspect deliveries from suppliers.

It would be incorrect to think of TQM as merely a collection of techniques. Rather, TQM reflects a whole new attitude toward quality. It is about the *culture* of an organization. To truly reap the benefits of TQM, the organization must change its culture.

Continuous improvement

Philosophy that seeks to make never-ending improvements to the process of converting inputs into outputs.

Kaizen Japanese term for continuous improvement.

Quality at the source The philosophy of making each worker responsible for the quality of his or her work.

The iPod Shuffle stops playing music when the earphone jack is unplugged. When the earphones are plugged back in, the music resumes right where it left off. This keeps the battery from running down and is an example of mistake proofing.



Roman Tiraspolsky/123RF

TABLE 9.6

Comparing the cultures of TQM and traditional organizations

Aspect	Traditional	TQM
Overall mission	Maximize return on investment	Meet or exceed customer expectations
Objectives	Emphasis on short term	Balance of long term and short term
Management	Not always open; sometimes inconsistent objectives	Open; encourages employee input; consistent objectives
Role of manager	Issue orders; enforce	Coach; remove barriers; build trust
Customer requirements	Not highest priority; may be unclear	Highest priority; important to identify and understand
Problems	Assign blame; punish	Identify and resolve
Problem solving	Not systematic; individuals	Systematic; teams
Improvement	Erratic	Continuous
Suppliers	Adversarial	Partners
Jobs	Narrow, specialized; much individual effort	Broad, more general; much team effort
Focus	Product oriented	Process oriented

Table 9.6 illustrates the differences between cultures of a TQM organization and a more traditional organization.

Obstacles to Implementing TQM

Companies have had varying success in implementing TQM. Some have been quite successful, but others have struggled. Part of the difficulty may be with the process by which it is implemented rather than with the principles of TQM. Among the factors cited in the literature are the following:

- Lack of a companywide definition of quality: Efforts aren't coordinated; people are working at cross-purposes, addressing different issues, and using different measures of success.

- Lack of a strategic plan for change: Without such a plan the chance of success is lessened and the need to address strategic implications of change is ignored.
- Lack of a customer focus: Without a customer focus, there is a risk of customer dissatisfaction.
- Poor intraorganizational communication: The left hand doesn't know what the right hand is doing; frustration, waste, and confusion ensue.
- Lack of employee empowerment: Not empowering employees gives the impression of not trusting employees to fix problems, adds red tape, and delays solutions.
- View of quality as a “quick fix”: Quality needs to be a long-term, continuing effort.
- Emphasis on short-term financial results: “Duct-tape” solutions often treat symptoms; spend a little now—a lot more later.
- Inordinate presence of internal politics and “turf” issues: These can sap the energy of an organization and derail the best of ideas.
- Lack of strong motivation: Managers need to make sure employees are motivated.
- Lack of time to devote to quality initiatives: Don't add more work without adding additional resources.
- Lack of leadership: Managers need to be leaders.⁵

This list of potential problems can serve as a guideline for organizations contemplating implementing TQM or as a checklist for those having trouble implementing it.

Criticisms of TQM

TQM programs are touted as a way for companies to improve their competitiveness, which is a very worthwhile objective. Nonetheless, TQM programs are not without criticism. The following are some of the major criticisms:

- Overzealous advocates may pursue TQM programs blindly, focusing attention on quality even though other priorities may be more important (e.g., responding quickly to a competitor's advances).
- Programs may not be linked to the strategies of the organization in a meaningful way.
- Quality-related decisions may not be tied to market performance. For instance, customer satisfaction may be emphasized to the extent that its cost far exceeds any direct or indirect benefit of doing so.
- Failure to carefully plan a program before embarking on it can lead to false starts, employee confusion, and meaningless results.
- Organizations sometimes pursue continuous improvement (i.e., *incremental* improvement) when *dramatic* improvement is needed.
- Quality efforts may not be tied to results.

Note that there is nothing inherently wrong with TQM; the problem is how some individuals or organizations misuse it. Let's turn our attention to problem solving and process improvement.

⁵Excerpt from Gary Salegna and Farzaneh Fazel, “Obstacles to Implementing Quality.” *Quality Progress*, July 2000, p. 53.

9.9 PROBLEM SOLVING AND PROCESS IMPROVEMENT

LO9.10 Give an overview of problem solving.

Problem solving is one of the basic procedures of TQM. In order to be successful, problem-solving efforts should follow a standard approach. Table 9.7 describes the basic steps in the TQM problem-solving process.

An important aspect of problem solving in the TQM approach is *eliminating* the cause so that the problem does not recur. This is why users of the TQM approach often like to think of problems as “opportunities for improvement.”

The Plan-Do-Study-Act Cycle

Plan-do-study-act (PDSA) cycle A framework for problem solving and improvement activities.

The **plan-do-study-act (PDSA) cycle**, also referred to as either the Shewhart cycle or the Deming wheel, is the conceptual basis for problem-solving activities. The cycle is illustrated in Figure 9.1. Representing the process with a circle underscores its continuing nature. There are four basic steps in the cycle:

Plan. Begin by studying the current process. Document that process, and then collect data on the process or problem. Next, analyze the data and develop a plan for improvement. Specify measures for evaluating the plan.

Do. Implement the plan, on a small scale if possible. Document any changes made during this phase. Collect data systematically for evaluation.

Study. Evaluate the data collection during the *do* phase. Check how closely the results match the original goals of the *plan* phase.

Act. If the results are successful, *standardize* the new method and communicate the new method to all people associated with the process. Implement training for the new method. If the results are unsuccessful, revise the plan and repeat the process or cease this project.

Employing this sequence of steps provides a systematic approach to continuous improvement.

Process improvement is a *systematic* approach to improving a process. It involves documentation, measurement, and analysis for the purpose of improving the functioning of a process.

Process improvement A systematic approach to improving a process.

TABLE 9.7

Basic steps in problem solving

Step 1	Define the problem and establish an improvement goal. Give problem definition careful consideration; don't rush through this step because this will serve as the focal point of problem-solving efforts.
Step 2	Develop performance measures and collect data. The solution must be based on <i>facts</i> . Possible tools include check sheet, scatter diagram, histogram, run chart, and control chart.
Step 3	Analyze the problem. Possible tools include Pareto chart, cause-and-effect diagram.
Step 4	Generate potential solutions. Methods include brainstorming, interviewing, and surveying.
Step 5	Choose a solution. Identify the criteria for choosing a solution. (Refer to the goal established in Step 1.) Apply criteria to potential solutions and select the best one.
Step 6	Implement the solution. Keep everyone informed.
Step 7	Monitor the solution to see if it accomplishes the goal. If not, modify the solution, or return to Step 1. Possible tools include control chart and run chart.

A. The PDSA cycle

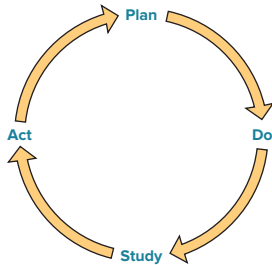

B. The PDSA cycle applied to problem solving

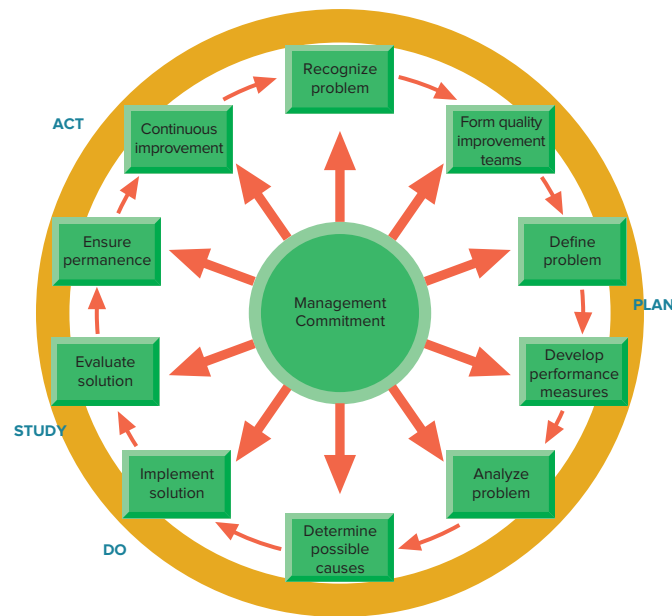

FIGURE 9.1

Source: Figure from Donna Summers, *Quality*, 2nd ed., p. 67. 2000. Prentice Hall, Inc. Pearson Education, Inc., Upper Saddle River, NJ.

Typical goals of process improvement include increasing customer satisfaction, achieving higher quality, reducing waste, reducing cost, increasing productivity, and reducing processing time.

Table 9.8 provides an overview of process improvement.

A. Map the process

1. Collect information about the process; identify each step in the process. For each step, determine:
 - The inputs and outputs.
 - The people involved.
 - The decisions that are made.
 Document such measures as time, cost, space used, waste, employee morale and any employee turnover, accidents and/or safety hazards, working conditions, revenues and/or profits, quality, and customer satisfaction, as appropriate.
2. Prepare a flowchart that *accurately* depicts the process. Make sure key activities and decisions are represented.

B. Analyze the process

1. Ask these questions about the process:
 - Is the flow logical?
 - Are any steps or activities missing?
 - Are there any duplications?
2. Ask these questions about each step:
 - Could it be eliminated?
 - Does the step add value?
 - Does any waste occur at this step?
 - Could the time be shortened?
 - Could the cost to perform the step be reduced?
 - Could two (or more) steps be combined?

C. Redesign the process

Using the results of the analysis, redesign the process. Document the improvements; potential measures include reductions in time, cost, space, waste, employee turnover, accidents, safety hazards, and increases/improvements in employee morale, working conditions, revenues/profits, quality, and customer satisfaction.

TABLE 9.8

Overview of process improvement

LO9.11 Give an overview of process improvement.

LO9.12 Describe the Six Sigma methodology.

Six Sigma A business process for improving quality, reducing costs, and increasing customer satisfaction.

Six Sigma

The term **Six Sigma** has several meanings. Statistically, Six Sigma means having no more than 3.4 defects per million opportunities in any process, product, or service. Conceptually, the term is much broader, referring to a program designed to reduce the occurrence of defects to achieve lower costs and improved customer satisfaction. It is based on the application of certain tools and techniques to selected projects to achieve strategic business results. In the business world, Six-Sigma programs have become a key way to improve quality, save time, cut costs, and improve customer satisfaction. Six-Sigma programs can be employed in design, production, service, inventory management, and delivery. It is important for Six-Sigma projects to be aligned with organization strategy.

Motorola pioneered the concept of a Six-Sigma program in the 1980s and actually trademarked the term. Today, Six-Sigma concepts are widely used by businesses, governments, consultants, and even the military as a business performance methodology.

There are management and technical components of Six-Sigma programs. The management component involves providing strong leadership, defining performance metrics, selecting projects likely to achieve business results, and selecting and training appropriate people. The technical component involves improving process performance, reducing variation, utilizing statistical methods, and designing a structured improvement strategy, which involves definition, measurement, analysis, improvement, and control.

For Six Sigma to succeed in any organization, buy-in at the top is essential. Top management must formulate and communicate the company's overall objectives and lead the program for a successful deployment. Other key players in Six-Sigma programs are program champions, "master black belts," "black belts," and "green belts." Champions identify and rank potential projects, help select and evaluate candidates, manage program resources, and serve as advocates for the program. Master black belts have extensive training in statistics and use of quality tools. They are teachers and mentors of black belts. Black belts are project team leaders responsible for implementing process improvement projects. They have typically completed four weeks of Six-Sigma training and have demonstrated mastery of the subject matter through an exam and successful completion of one or more projects. Green belts are members of project teams.

Black belts play a pivotal role in the success of Six-Sigma programs. They influence change, facilitate teamwork, provide leadership in applying tools and techniques, and convey knowledge and skills to green belts. Black belt candidates generally have a proven strength in either a technical discipline such as engineering or a business discipline. Candidates also must have strong "people skills" and be able to facilitate change. In addition, they must be proficient in applying continuous improvement, as well as statistical methods and tools. A black belt must understand the technical aspects of process improvement, and also the expected business results (time, money, and quality improvement).

Six Sigma is based on these guiding principles:

- Reduction of variation is an important goal.
- The methodology is data driven; it requires valid measurements.
- Outputs are determined by inputs; focus on modifying and/or controlling inputs to improve outputs.
- Only a critical few inputs have a significant impact on outputs (the Pareto effect); concentrate on those.

DMAIC (define-measure-analyze-improve-control) is a formalized problem-solving process of Six Sigma. It is composed of five steps that can be applied to any process to improve its effectiveness. The steps are:

1. **Define:** Set the context and objectives for improvement.
2. **Measure:** Determine the baseline performance and capability of the process.
3. **Analyze:** Use data and tools to understand the cause-and-effect relationships of the process.
4. **Improve:** Develop the modifications that lead to a validated improvement in the process.
5. **Control:** Establish plans and procedures to ensure that improvements are sustained.

9.10 QUALITY TOOLS

An organization can use a number of tools for problem solving and process improvement. This section describes eight of these tools, which aid in data collection and interpretation, and provide the basis for decision making.

The first seven tools are often referred to as the *seven basic quality tools*. Figure 9.2 provides a quick overview of the seven tools.

Flowcharts. A **flowchart** is a visual representation of a process. As a problem-solving tool, a flowchart can help investigators identify possible points in a process where problems occur. Figure 9.3 illustrates a flowchart for catalog telephone orders in which potential failure points are highlighted.

The diamond shapes in the flowchart represent decision points in the process, and the rectangular shapes denote procedures. The arrows show the direction of “flow” of the steps in the process.

To construct a simple flowchart, begin by listing the steps in a process. Then, classify each step as either a procedure or a decision (or check) point. Try not to make the flowchart too detailed or it may be overwhelming, but be careful not to omit any key steps either.

Check sheets. A **check sheet** is a simple tool frequently used for problem identification. Check sheets provide a format that enables users to record and organize data in a way that facilitates collection and analysis. This format might be one of simple checkmarks. Check sheets are designed on the basis of what the users are attempting to learn by collecting data.

Many different formats can be used for a check sheet, and there are many different types of sheets. One frequently used form of check sheet deals with type of defect, another with location of defects. These are illustrated in Figures 9.4 and 9.5

Figure 9.4 shows tallies that denote the type of defect and the time of day each occurred. Problems with missing labels tend to occur early in the day and smeared print tends to occur late in the day, whereas off-center labels are found throughout the day. Identifying types of defects and when they occur can help pinpoint causes of the defects.

Figure 9.5 makes it easy to see where defects on the product—in this case, a glove—are occurring. Defects seem to be occurring on the tips of the thumb and first finger, in the finger valleys (especially between the thumb and first finger), and in the center of the gloves. Again, this may help determine why the defects occur and lead to a solution.

Histograms. A **histogram** can be useful in getting a sense of the distribution of observed values. Among other things, one can see if the distribution is symmetrical, what the range of values is, and if there are any unusual values. Figure 9.6 illustrates a histogram. Note the two peaks. This suggests the possibility of *two* distributions with different centers. Possible causes might be two workers or two suppliers with different quality.

Pareto Analysis. **Pareto analysis** is a technique for focusing attention on the most important problem areas. The Pareto concept, named after the 19th-century Italian economist Vilfredo Pareto, is that a relatively few factors generally account for a large percentage of the total cases (e.g., complaints, defects, problems). The idea is to classify the cases according to degree of importance and focus on resolving the most important, leaving the less important. Often referred to as the 80–20 rule, the Pareto concept states that approximately 80 percent of the problems come from 20 percent of the items. For instance, 80 percent of machine breakdowns come from 20 percent of the machines, and 80 percent of the product defects come from 20 percent of the causes of defects.

Often, it is useful to prepare a chart that shows the number of occurrences by category, arranged in order of frequency. Figure 9.7 illustrates such a chart corresponding to the check sheet shown in Figure 9.4. The dominance of the problem with off-center labels becomes apparent. Presumably, the manager and employees would focus on trying to resolve this problem.

LO9.13 Describe and use various quality tools.

Flowchart A diagram of the steps in a process.

Check sheet A tool for recording and organizing data to identify a problem.

Histogram A chart of an empirical frequency distribution.

Pareto analysis Technique for classifying problem areas according to degree of importance, and focusing on the most important.

FIGURE 9.2 The seven basic quality tools

Flowchart

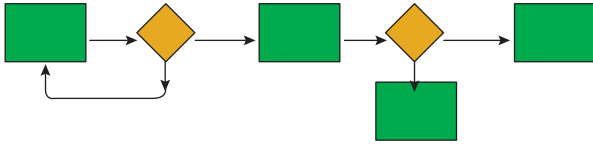

A diagram of the steps in a process

Check sheet

Defect	Day			
	1	2	3	4
A	///		///	/
B	//	/	//	///
C	/	///	//	///

A tool for organizing and collecting data; a tally of problems or other events by category

Histogram

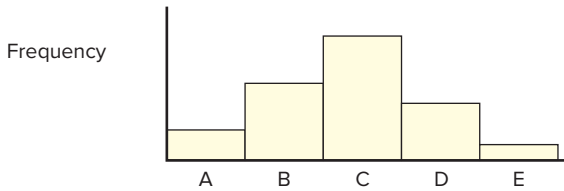

A chart that shows an empirical frequency distribution

Pareto chart

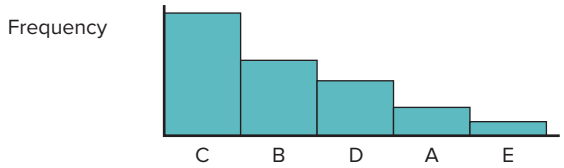

A diagram that arranges categories from highest to lowest frequency of occurrence

Scatter diagram

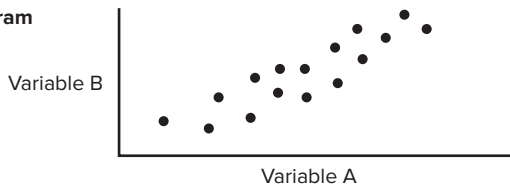

A graph that shows the degree and direction of relationship between two variables

Control chart

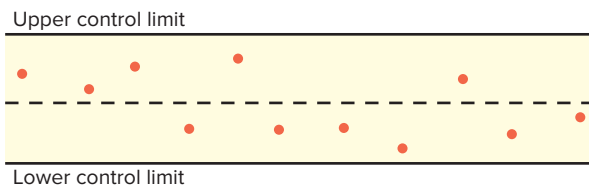

A statistical chart of time-ordered values of a sample statistic (e.g., sample means)

Cause-and-effect diagram

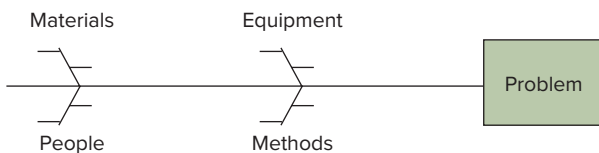

A diagram used to organize a search for the cause(s) of a problem; also known as a *fishbone* diagram

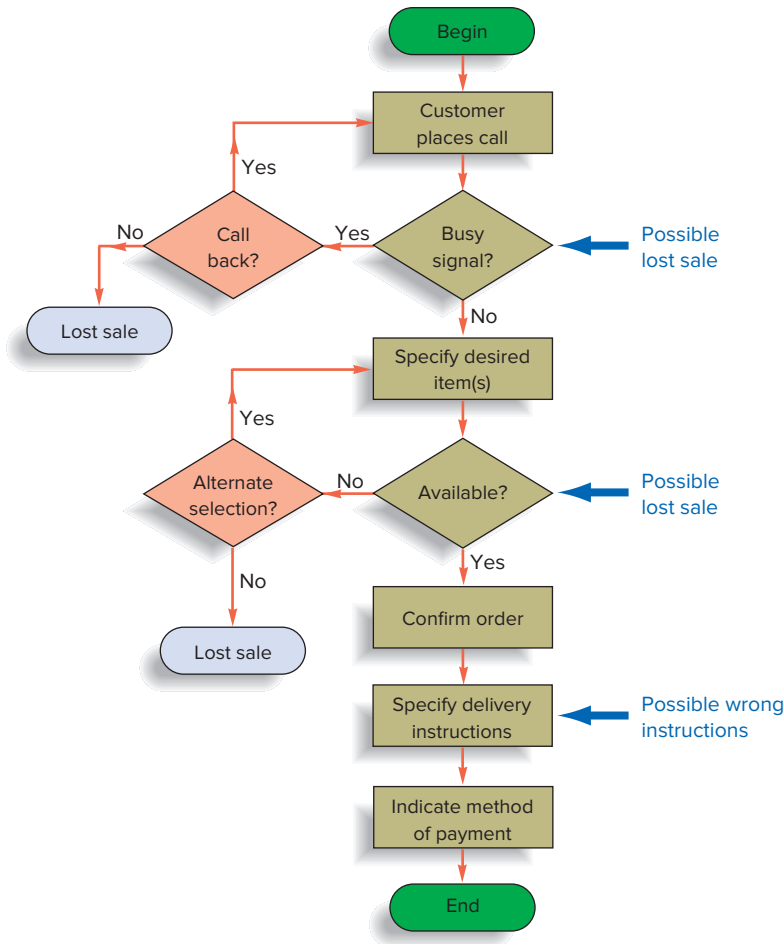
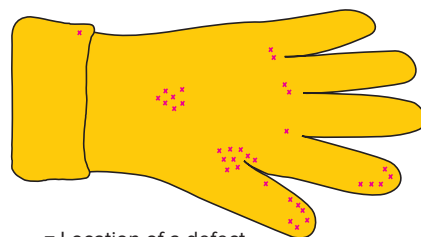

FIGURE 9.3
Flowchart of catalog call

Day	Time	Type of Defect					Total
		Missing label	Off-center	Smeared print	Loose or folded	Other	
M	8-9						6
	9-10						3
	10-11						5
	11-12					(Torn)	3
	1-2						1
	2-3						6
	3-4						8
Total		5	14	10	2	1	32

FIGURE 9.4
An example of a check sheet



x = Location of a defect

FIGURE 9.5
A special-purpose check sheet

FIGURE 9.6
A histogram

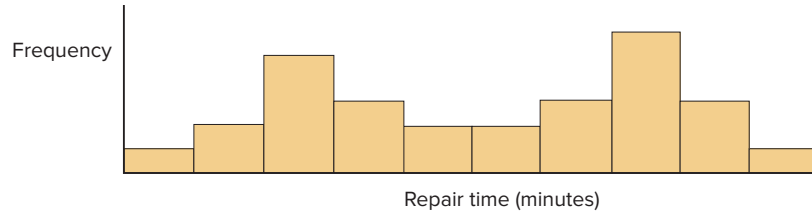
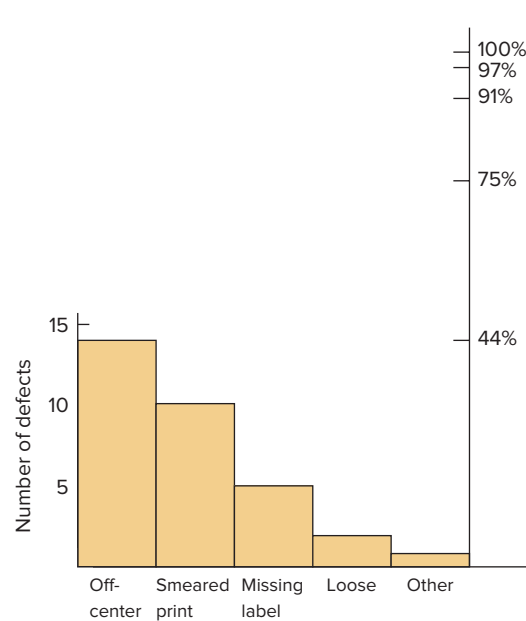

FIGURE 9.7
A Pareto diagram based on data in Figure 9.4



Once they accomplished that, they could address the remaining defects in similar fashion; “smeared print” would be the next major category to be resolved, and so on. Additional check sheets would be used to collect data to verify that the defects in these categories have been eliminated or greatly reduced. Hence, in later Pareto diagrams, categories such as “off-center” may still appear but would be much less prominent.

Scatter diagram A graph that shows the degree and direction of relationship between two variables.

Scatter Diagrams. A **scatter diagram** can be useful in deciding if there is a correlation between the values of two variables. A correlation may point to a cause of a problem. Figure 9.8 shows an example of a scatter diagram. In this particular diagram, there is a *positive* (upward-sloping) relationship between the humidity and the number of errors per hour. High values of humidity correspond to high numbers of errors, and vice versa. On the other hand, a *negative* (downward-sloping) relationship would mean that when values of one variable are low, values of the other variable are high, and vice versa.

The higher the correlation between the two variables, the less scatter in the points; the points will tend to line up. Conversely, if there were little or no relationship between two variables, the points would be completely scattered. In Figure 9.8, the correlation between humidity and errors seems strong because the points appear to scatter along an imaginary line.

Control chart A statistical chart of time-ordered values of a sample statistic.

Control Charts. A **control chart** can be used to monitor a process to see if the process output is random. It can help detect the presence of *correctable* causes of variation. Figure 9.9 illustrates a control chart. Control charts also can indicate when a problem occurred and give

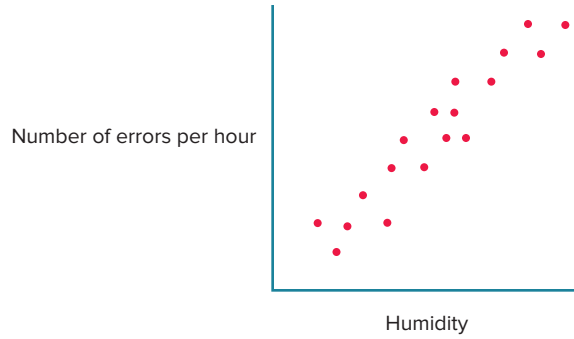

FIGURE 9.8
A scatter diagram

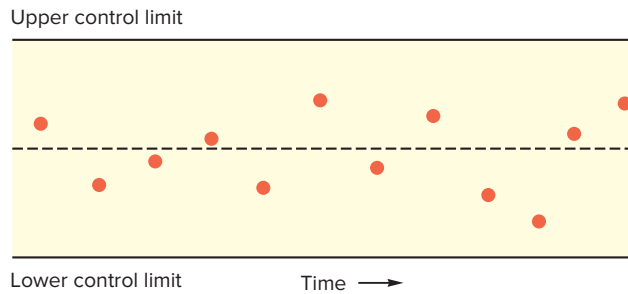

FIGURE 9.9
A control chart

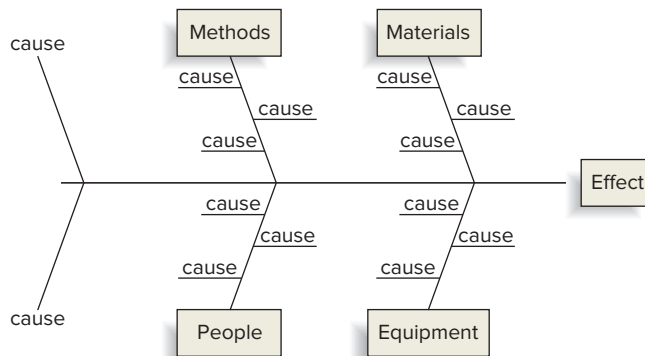

FIGURE 9.10
One format of a cause-and-effect diagram

insight into what caused the problem. Control charts were introduced in Chapter 3, and are described in detail in Chapter 10.

Cause-and-Effect Diagrams. A **cause-and-effect diagram** offers a structured approach to the search for the possible cause(s) of a problem. It is also known as a *fishbone diagram* because of its shape, or an *Ishikawa diagram*, after the Japanese professor who developed the approach to aid workers overwhelmed by the number of possible sources of problems when problem solving. This tool helps to organize problem-solving efforts by identifying *categories* of factors that might be causing problems. This tool is often used after brainstorming sessions to organize the ideas generated. Figure 9.10 illustrates one form of a cause-and-effect diagram.

Cause-and-effect diagram A diagram used to search for the cause(s) of a problem; also called fishbone diagram.

Some errors are more likely causes than others, depending on the nature of the errors. If the cause is still not obvious at this point, additional investigation into the *root cause* may be necessary, involving a more in-depth analysis. Often, more detailed information can be obtained by asking *who, what, where, when, why, and how* questions about factors that appear to be the most likely sources of problems.

FIGURE 9.11 A run chart shows performance over time



Run chart Tool for tracking results over a period of time.

Run Charts. A **run chart** can be used to track the values of a variable over time. This can aid in identifying trends or other patterns that may be occurring. Figure 9.11 provides an example of a run chart showing a decreasing trend in accident frequency over time. Important advantages of run charts are ease of construction and ease of interpretation.

Illustrations of the Use of Graphical Tools

This section presents some illustrations of the use of graphical tools in process or product improvement. Figure 9.12 begins with a check sheet that can be used to develop a Pareto chart of the types of errors found. That leads to a more focused analysis of the most frequently occurring type of error using a cause-and-effect diagram. Additional cause-and-effect diagrams, such as errors by location, might also be used.

Figure 9.13 shows how Pareto charts measure the amount of improvement achieved in a before-and-after scenario of errors.

Figure 9.14 illustrates how control charts track two phases of improvement in a process that was initially out of control.

FIGURE 9.12 Employing graphical tools in problem solving

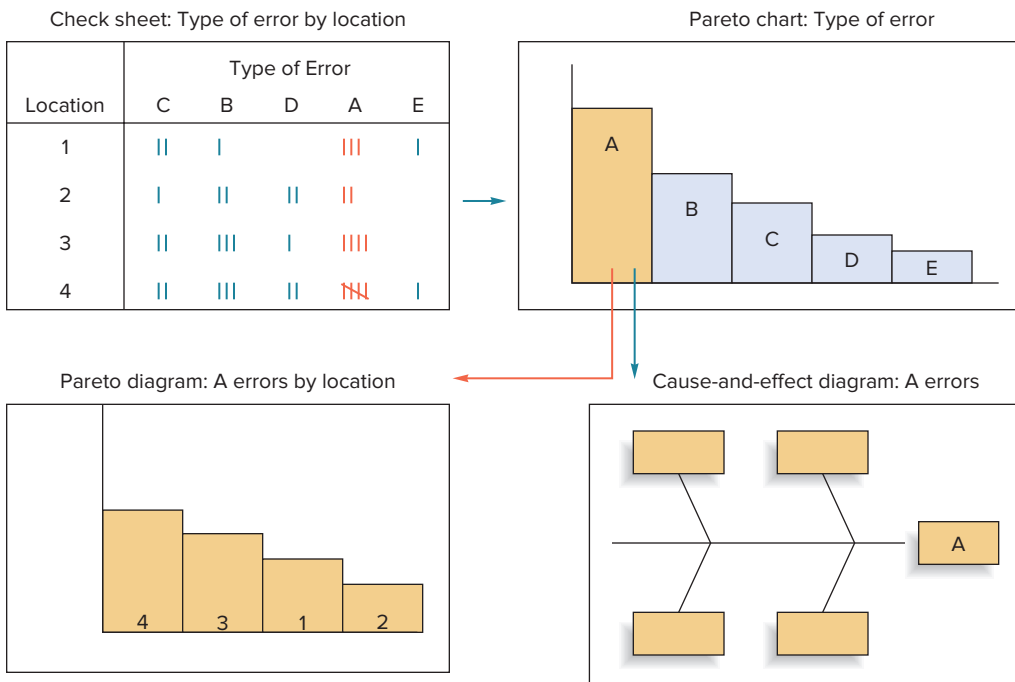

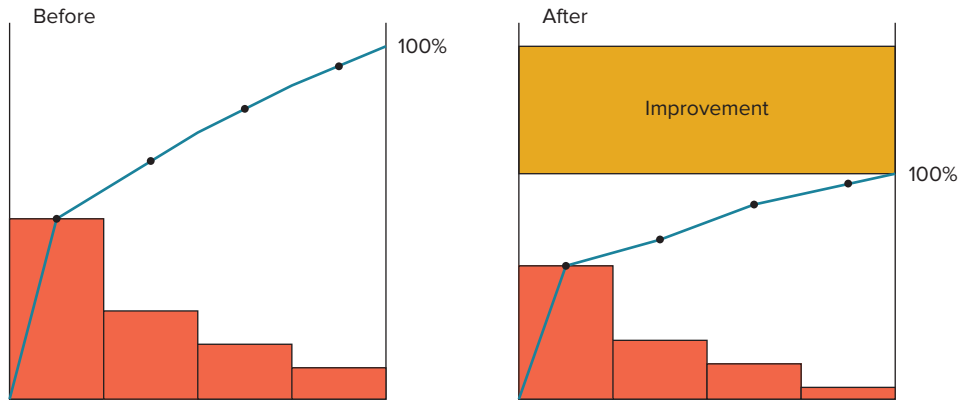

FIGURE 9.13
Comparison of before and after using Pareto charts

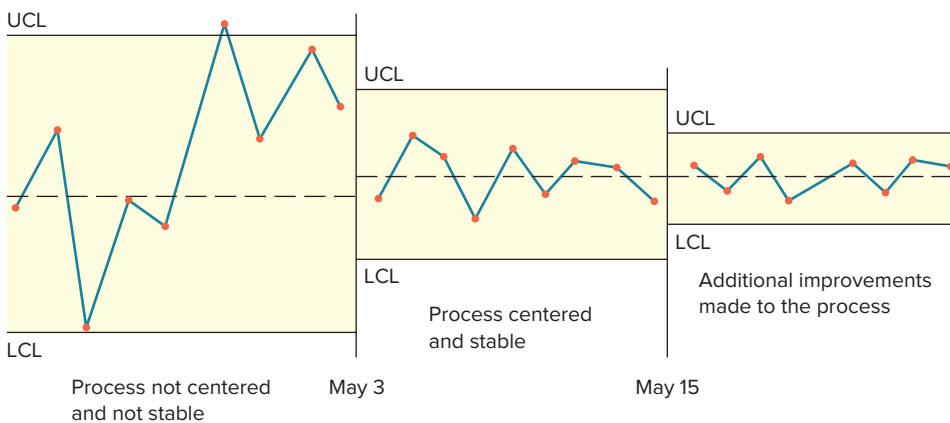

FIGURE 9.14
Using a control chart to track improvements

UCL = Upper Control Limit
LCL = Lower Control Limit

Methods for Generating Ideas

Some additional tools that are useful for problem solving and/or for process improvement are brainstorming, quality circles, and benchmarking.

Brainstorming. Brainstorming is a technique in which a group of people share thoughts and ideas on problems in a relaxed atmosphere that encourages unrestrained collective thinking. The goal is to generate a free flow of ideas on identifying problems, and finding causes, solutions, and ways to implement solutions. In successful brainstorming, criticism is absent, no single member is allowed to dominate sessions, and all ideas are welcomed. Structured brainstorming is an approach to assure that everyone participates.

Brainstorming Technique for generating a free flow of ideas in a group of people.

Quality Circles. One way companies have tapped employees for ideas concerning quality improvement is through **quality circles**. The circles comprise a number of workers who get together periodically to discuss ways of improving products and processes. Not only are quality circles a valuable source of worker input, they also can motivate workers, if handled properly, by demonstrating management interest in worker ideas. Quality circles are usually less structured and more informal than teams involved in continuous improvement, but in some organizations quality circles have evolved into continuous improvement teams. Perhaps a major distinction between quality circles and teams is the amount of authority given to the teams.

Quality circles Groups of workers who meet to discuss ways of improving products or processes.

Typically, quality circles have had very little authority to implement any but minor changes; continuous improvement teams are sometimes given a great deal of authority. Consequently, continuous improvement teams have the added motivation generated by *empowerment*.

TABLE 9.9

The benchmarking approach

1. What organizations do it the best?
2. How do they do it?
3. How do we do it now?
4. How can we change to match or exceed the best?

Benchmarking Process of measuring performance against the best in the same or another industry.

Benchmarking. **Benchmarking** is an approach that can inject new energy into improvement efforts. Summarized in Table 9.9, benchmarking is the process of measuring an organization's performance on a key customer requirement against the best in the industry, or against the best in any industry. Its purpose is to establish a standard against which performance is judged, and to identify a model for learning how to improve. A benchmark demonstrates the degree to which customers of other organizations are satisfied.

Once a benchmark has been identified, the goal is to meet or exceed that standard through improvements in appropriate processes. The benchmarking process usually involves these steps:

1. Identify a critical process that needs improvement (e.g., order entry, distribution, service after sale).
2. Identify an organization that excels in the process, preferably the best.
3. Contact the benchmark organization, visit it, and study the benchmark activity.
4. Analyze the data.
5. Improve the critical process at your own organization.

Selecting an industry leader provides insight into what competitors are doing, but competitors may be reluctant to share this information. Several organizations are responding to this difficulty by conducting benchmarking studies and providing that information to other organizations without revealing the sources of the data. Selecting organizations that are world leaders in different industries is another alternative.

Hewlett-Packard (HP), a world leader in research and development, created the TouchSmart PC. Joint research with universities, customers, and partners meets the scientific and business objectives of HP. This model is a benchmark for other companies.



Yoshikazu Tsuno/AFP/Getty Images

9.11 OPERATIONS STRATEGY

All customers are concerned with the quality of goods or services they receive. For this reason alone, business organizations have a vital, strategic interest in achieving and maintaining high quality standards. Moreover, there is a positive link between quality and productivity, giving an additional incentive for achieving high quality and being able to present that image to current and potential customers.

The best business organizations view quality as a never-ending journey. That is, they strive for continual improvement with the attitude that no matter how good quality is, it can always be improved, and there are benefits for doing so.

In order for total quality management to be successful, it is essential that a majority of those in an organization buy in to the idea. Otherwise, there is a risk that a significant portion of the benefits of the approach will not be realized. Therefore, it is important to give this sufficient attention, and to confirm that concordance exists before plunging ahead. A key aspect of this is a top-down approach: Top management needs to be visibly involved and needs to be supportive, both financially and emotionally. Also important is educating managers and workers in the concepts, tools, and procedures of quality. Again, if education is incomplete, there is the risk that TQM will not produce the desired benefits.

And here's a note of caution: Although customer retention rates can have a dramatic impact on profitability, customer satisfaction does not always guarantee customer loyalty. Consequently, organizations may need to develop a retention strategy to deal with this possibility.

It is not enough for an organization to incorporate quality into its operations; the entire supply chain must be involved. Problems such as defects in purchased parts, long lead times, and late or missed deliveries of goods or services all negatively impact an organization's ability to satisfy its customers. So it is essential to incorporate quality throughout the supply chain.

This chapter presents philosophies and tools that can be used to achieve high quality and continually improve quality. Quality is the culmination of efforts of the entire organization and its supply chain. It begins with careful assessment of what the customers want, then translating this information into technical specifications to which goods or services must conform. The specifications guide product and service design, process design, production of goods and delivery of services, and service after the sale or delivery.

The consequences of poor quality include loss of market share, liability claims, a decrease in productivity, and an increase in costs. Quality costs include costs related to prevention, appraisal, and failure. Determinants of quality are design, conformance to design, ease of use, and service after delivery.

Modern quality management is directed at preventing mistakes rather than finding them after they occur and reducing process output variation. Currently, the business community shows widespread interest in improving quality and competitiveness.

The chapter includes a description of the key contributors to quality management, and it outlines the ISO 9000, ISO 14000, and ISO 24700 international quality standards.

Three awards of distinction—the Baldrige Award, the European Quality Award, and the Deming Prize—are given annually to organizations that have shown great achievement in quality management.

Total quality management is a never-ending pursuit of quality that involves everyone in an organization. The driving force is customer satisfaction, and a key philosophy is continuous improvement. Training of managers and workers in quality concepts, tools, and procedures is an important aspect of the approach. Teams are an integral part of TQM.

Two major aspects of the TQM approach are problem solving and process improvement. Six-Sigma programs are a form of TQM. They emphasize the use of statistical and management science tools on selected projects to achieve business results.

1. Price and quality are the two primary considerations in every buying transaction, so quality is extremely important.
2. Quality gurus have made important contributions to the way business organizations view quality and achieve it.
3. Quality certification and quality awards are important because they can provide some degree of assurance to customers about quality.
4. Many simple-to-use tools are available for problem solving and process improvement.

SUMMARY

KEY POINTS

KEY TERMS

appraisal costs, 389	failure costs, 389	quality, 379
Baldrige Award, 391	flowchart, 401	quality at the source, 395
benchmarking, 408	histogram, 401	quality circles, 407
brainstorming, 407	internal failures, 389	quality of conformance, 386
cause-and-effect (fishbone) diagram, 405	ISO 9000, 392	quality of design, 386
check sheet, 401	ISO 14000, 392	return on quality, 390
continuous improvement, 395	ISO 24700, 393	run chart, 406
control chart, 404	kaizen, 395	scatter diagram, 404
Deming Prize, 381	Pareto analysis, 401	Six Sigma, 400
European Quality Award, 391	plan-do-study-act (PDSA) cycle, 398	total quality management (TQM), 394
external failures, 389	prevention costs, 389	
fail-safing, 394	process improvement, 398	

SOLVED PROBLEM

Problem The county sheriff's department handed out the following tickets on a summer weekend. Make a check sheet and a Pareto diagram for the types of infractions.

Ticket Number	Infraction
1	Excessive speed
2	Expired inspection
3	Improper turn
4	Excessive speed
5	Parking violation
6	Parking violation
7	Excessive speed
8	Parking violation
9	Improper turn
10	Parking violation
11	Expired inspection
12	Parking violation
13	Improper turn
14	Parking violation
15	Excessive speed
16	Parking violation
17	Parking violation
18	Parking violation
19	Excessive speed
20	Parking violation

Solution Check sheet (list the types of infractions, tally, summarize frequencies):

Infraction	Tally	Frequency
Excessive speed	///	5
Expired inspection	//	2
Improper turn	///	3
Parking violation	/// ///	10

Pareto diagram (arrange infractions from highest frequency to lowest):

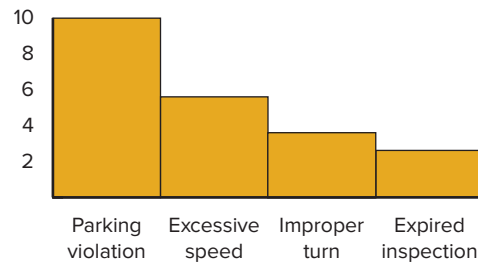

1. List and briefly explain:
 - a. The dimensions of service quality
 - b. The determinants of quality
2. Define the terms *quality of design* and *quality of conformance*.
3. What are some possible consequences of poor quality?
4. Use the dimensions of quality to describe typical characteristics of these products and services:
 - a. A television set
 - b. A restaurant meal (product)
 - c. A restaurant meal (service)
 - d. Painting a house
 - e. Surgery and postsurgery care
5. Many product reviews are available on the internet. Two examples are reviews on electronics products such as DVD players and high-definition televisions. There are often both positive and negative reviews.
 - a. Do such reviews (positive and negative) influence your purchasing decisions? Why or why not?
 - b. Why do you suppose consumers take the time and effort to write such reviews?
 - c. There is often a feedback button asking if you found the review helpful. Do you usually respond? Why or why not?
6. Describe the quality–ethics connection.
7. Select one of the quality gurus and briefly describe his major contributions to quality management.
8.
 - a. What is ISO 9000, and why is it important for global businesses to have ISO 9000 certification?
 - b. Compare the Baldrige Award and ISO certification. If an organization were going to seek both, which one should it seek first? Why?
9. Briefly explain how a company can achieve lower production costs and increase productivity by improving the quality of its products or services.
10. What are the key elements of the TQM approach? What is the driving force behind TQM?
11. Briefly describe each of the seven quality tools.
12. Briefly define or explain each of these tools:
 - a. Brainstorming
 - b. Benchmarking
 - c. Run charts
13. Explain the plan-do-study-act cycle.
14. List the steps of problem solving.
15. Select four tools and describe how they could be used in problem solving.
16. List the steps of process improvement.
17. Select four tools and describe how they could be used for process improvement.

DISCUSSION AND REVIEW QUESTIONS

TAKING STOCK

1. What trade-offs are involved in deciding on whether to offer a product or service guarantee?
2. Who needs to be involved in setting priorities for quality improvement?
3. Name several ways that technology has had an impact on quality.

CRITICAL THINKING EXERCISES

1. A computer repair shop had received a number of complaints on the length of time it took to make repairs. The manager responded by increasing the repair staff by 10 percent. Complaints on repair time quickly decreased, but then complaints on the cost of repairs suddenly increased. Oddly enough, when repair costs were analyzed, the manager found that the average cost of repair had actually decreased relative to what it was before the increase in staff. What are some possible explanations for the complaints, and what actions might the manager contemplate?
2. As a manager, how would you deal with the possibility that customer satisfaction does not always lead to customer retention?
3. What quality-related trade-offs might there be between having a single large, centralized produce-processing facility and having many small, decentralized produce-processing facilities?
4. Give three examples of what would be considered unethical behavior involving management of quality, and state which ethical principle (see Chapter 1) is violated.

PROBLEMS

1. Make a check sheet and then a Pareto diagram for the following car repair shop data.

Ticket No.	Work	Ticket No.	Work	Ticket No.	Work
1	Tires	11	Brakes	21	Lube & oil
2	Lube & oil	12	Lube & oil	22	Brakes
3	Tires	13	Battery	23	Transmission
4	Battery	14	Lube & oil	24	Brakes
5	Lube & oil	15	Lube & oil	25	Lube & oil
6	Lube & oil	16	Tires	26	Battery
7	Lube & oil	17	Lube & oil	27	Lube & oil
8	Brakes	18	Brakes	28	Battery
9	Lube & oil	19	Tires	29	Brakes
10	Tires	20	Brakes	30	Tires

2. An air-conditioning repair department manager has compiled data on the primary reason for 41 service calls for the previous week, as shown in the table. Using the data, make a check sheet for the problem types for each customer type, and then construct a Pareto diagram for each type of customer.

Key Problem type:

N = Noisy

F = Equipment failure

W = Runs warm

O = Odor

Customer type:

C = Commercial customer

R = Residential customer

Job Number	Problem/ Customer Type	Job Number	Problem/ Customer Type	Job Number	Problem/ Customer Type
301	F/R	315	F/C	329	O/C
302	O/R	316	O/C	330	N/R
303	N/C	317	W/C	331	N/R
304	N/R	318	N/R	332	W/R
305	W/C	319	O/C	333	O/R
306	N/R	320	F/R	334	O/C
307	F/R	321	F/R	335	N/R
308	N/C	322	O/R	336	W/R
309	W/R	323	F/R	337	O/C
310	N/R	324	N/C	338	O/R
311	N/R	325	F/R	339	F/R
312	F/C	326	O/R	340	N/R
313	N/R	327	W/C	341	O/C
314	W/C	328	O/C		

- Prepare a run chart similar to Figure 9.11 for the occurrences of defective computer monitors based on the following data, which an analyst obtained from the process for making the monitors. Workers are given a 15-minute break at 10:15 a.m. and 3:15 p.m., and a lunch break at noon. What can you conclude?

Interval Start Time	Number of Defects	Interval Start Time	Number of Defects	Interval Start Time	Number of Defects
8:00	1	10:45	0	2:15	0
8:15	0	11:00	0	2:30	2
8:30	0	11:15	0	2:45	2
8:45	1	11:30	1	3:00	3
9:00	0	11:45	3	3:30	0
9:15	1	1:00	1	3:45	1
9:30	1	1:15	0	4:00	0
9:45	2	1:30	0	4:15	0
10:00	3	1:45	1	4:30	1
10:30	1	2:00	1	4:45	3

- Prepare a run diagram for this emergency call data. Use five-minute intervals (i.e., count the calls received in each five-minute interval. Use intervals of 0 to 4, 5 to 9, etc.). *Note:* Two or more calls may occur in the same minute; there were three operators on duty this night. What can you conclude from the run chart?

Call	Time	Call	Time	Call	Time	Call	Time
1	1:03	12	1:36	23	1:56	34	2:08
2	1:06	13	1:39	24	2:00	35	2:11
3	1:09	14	1:42	25	2:00	36	2:12
4	1:11	15	1:43	26	2:01	37	2:12
5	1:12	16	1:44	27	2:02	38	2:13
6	1:17	17	1:47	28	2:03	39	2:14
7	1:21	18	1:48	29	2:03	40	2:14
8	1:27	19	1:50	30	2:04	41	2:16
9	1:28	20	1:52	31	2:06	42	2:19
10	1:29	21	1:53	32	2:07		
11	1:31	22	1:56	33	2:08		

- Suppose that a table lamp fails to light when turned on. Prepare a simple cause-and-effect diagram to analyze possible causes.
- Prepare a cause-and-effect diagram to analyze the possible causes of late delivery of parts ordered from a supplier.
- Prepare a cause-and-effect diagram to analyze why a machine has produced a large run of defective parts.
- Prepare a scatter diagram for each of these data sets and then express in words the apparent relationship between the two variables. Put the first variable on the horizontal axis and the second variable on the vertical axis.

a.

Age	24	30	22	25	33	27	36	58	37	47	54	28	42	55
Absenteeism rate	6	5	7	6	4	5	4	1	3	2	2	5	3	1

b.

Temperature (°F)	65	63	72	66	82	58	75	86	77	65	79
Error rate	1	2	0	0	3	3	1	5	2	1	3

9. Prepare a flowchart that describes going to the library to study for an exam. Your flowchart should include these items: finding a place at the library to study; checking to see if you have your book, paper, highlighter, and so forth; traveling to the library; and the possibility of moving to another location if the place you chose to study starts to get crowded.
10. College students trying to register for a course sometimes find that the course has been closed, or the section they want has been closed. Prepare a cause-and-effect diagram for this problem.
11. The county sheriff's department responded to an unusually large number of vehicular accidents along a quarter-mile stretch of highway in recent months. Prepare a cause-and-effect diagram for this problem.
12. Suppose you are going to have a prescription filled at a local pharmacy. Referring to the dimensions of service quality for each dimension, give an example of how you would judge the quality of the service.

CASE



CHICK-N-GRAVY DINNER LINE

The operations manager of a firm that produces frozen dinners had received numerous complaints from supermarkets about the firm's Chick-n-Gravy dinners. The manager then asked her assistant, Ann, to investigate the matter and to report her recommendations.

Ann's first task was to determine what problems were generating the complaints. The majority of complaints centered on five defects: underfilled packages, a missing label, spills/mixed items, unacceptable taste, and improperly sealed packages.

Next, she took samples of dinners from the two production lines and examined each sample, making note of any defects she found. A summary of those results is shown in the table below.

The data resulted from inspecting approximately 800 frozen dinners. What should Ann recommend to the manager?

DEFECT OBSERVED

Date	Time	Line	Underfilled	Missing Label	Spill/ Mixed	Unacceptable Taste	Improperly Sealed
5/12	0900	1		✓✓	✓	✓✓✓	
5/12	1330	2			✓✓		✓✓
5/13	1000	2				✓	✓✓✓
5/13	1345	1	✓✓		✓✓		
5/13	1530	2		✓✓	✓✓✓		✓
5/14	0830	1		✓✓✓		✓✓✓	
5/14	1100	2	✓		✓		✓✓
5/14	1400	1			✓		✓
5/15	1030	1		✓✓✓		✓✓✓✓✓	
5/15	1145	2			✓	✓✓	
5/15	1500	1	✓		✓		
5/16	0845	2				✓✓	✓✓
5/16	1030	1		✓✓✓	✓	✓✓✓	
5/16	1400	1					
5/16	1545	2	✓	✓✓✓✓	✓	✓	✓✓



Tip Top Markets is a regional chain of supermarkets located in the southeastern United States. Karen Martin, manager of one of the stores, was disturbed by the large number of complaints from customers at her store, particularly on Tuesdays, so she obtained records from the store's customer service desk for the last nine Tuesdays. However, a few aren't really complaints, and not all are the responsibility of the store, so those shouldn't be included in her analysis.

Assume you have been asked to help analyze the data and to make recommendations for improvement. Analyze the data

using a check sheet, a Pareto diagram, and run charts. Then, construct a cause-and-effect diagram for the leading category on your Pareto diagram.

On July 15, changes were implemented to reduce out-of-stock complaints, improve store maintenance, and reduce checkout lines/pricing problems. Do the results of the last two weeks reflect improvement?

Based on your analysis, prepare a list of recommendations that will address customer complaints.

June 1

out of orange yogurt	produce not fresh
bread stale	lemon yogurt past sell date
checkout lines too long	couldn't find rice
overcharged	milk past sell date
double charged	stock clerk rude
meat smelled strange	cashier not friendly
charged for item not purchased	out of maple walnut ice cream
couldn't find the sponges	something green in meat
meat tasted strange	didn't like music
store too cold	checkout lines too slow
light out in parking lot	

June 15

wanted smaller size	overcharged on special
too cold in store	couldn't find aspirin
out of Wheaties	undercharged
out of Minute Rice	checkout lines too long
cashier rude	out of diet cola
fish tasted fishy	meat smelled bad
ice cream thawed	overcharged on eggs
double charged on hard rolls	bread not fresh
long wait at checkout	didn't like music
wrong price on item	lost wallet
overcharged	overcharged on bread
fish didn't smell right	

June 29

checkout line too long	restroom not clean
out of Dove soap	couldn't find sponges
out of Bisquick	checkout lines slow
eggs cracked	out of 18 oz. Tide
store not clean	out of Campbell's turkey soup
store too cold	out of pepperoni sticks
cashier too slow	checkout lines too long
out of skim milk	meat not fresh
charged wrong price	overcharged on melon

June 8

fish smelled funny	undercharged
out of diet bread	out of roses
dented can	meat spoiled
out of hamburger rolls	overcharged on two items
fish not fresh	store too warm
cashier not helpful	out of ice
meat tasted bad	telephone out of order
ATM ate card	overcharged
slippery floor	rolls stale
music too loud	bread past sale date

June 22

milk past sales date	couldn't find oatmeal
store too warm	out of Bounty paper towels
foreign object in meat	overcharged on orange juice
store too cold	lines too long at checkout
eggs cracked	couldn't find shoelaces
couldn't find lard	out of Smucker's strawberry jam
out of 42 oz. Tide	out of Frosted Flakes cereal
fish really bad	out of Thomas' English Muffins
windows dirty	

July 6

out of straws	store too warm
out of bird food	price not as advertised
overcharged on butter	need to open more checkouts
out of masking tape	shopping carts hard to steer
stockboy was not helpful	debris in aisles
lost child	out of Drano
meat looked bad	out of Chinese cabbage
overcharged on butter	store too warm
out of Swiss chard	floors dirty and sticky
too many people in store	out of Diamond chopped walnuts
out of bubble bath	
out of Dial soap	

(continued)

(concluded)

July 13

wrong price on spaghetti	undercharged
water on floor	out of brown rice
store looked messy	out of mushrooms
store too warm	overcharged
checkout lines too long	checkout wait too long
cashier not friendly	shopping cart broken
out of Cheese Doodles	couldn't find aspirin
triple charged	out of Tip Top lunch bags
out of Saran Wrap	out of Tip Top straws
out of Dove Bars	

July 27

out of bananas	wanted to know who won the lottery
reported accident in parking lot	store too warm
wrong price on cranapple juice	oatmeal spilled in bulk section
out of carrots	telephone out of order
out of fresh figs	out of Tip Top tissues
out of Tip Top napkins	water on floor
out of Tip Top straws	out of Tip Top paper towels
windows dirty	out of Tip Top toilet paper
out of iceberg lettuce	spaghetti sauce on floor
dislike store decorations	out of Peter Pan crunchy peanut butter
out of Tip Top lunch bags	
out of vanilla soy milk	

July 20

out of cucumbers	out of Tip Top toilet paper
checkout lines too slow	out of red peppers
found keys in parking lot	out of Tip Top napkins
lost keys	out of apricots
wrong price on sale item	telephone out of order
overcharged on corn	out of cocktail sauce
wrong price on baby food	water on floor
out of 18 oz. Tide	out of onions
out of Tip Top tissues	out of squash
checkout lines too long	out of iceberg lettuce
out of romaine lettuce	out of Tip Top paper towels

**SELECTED
BIBLIOGRAPHY AND
FURTHER READINGS**

- Besterfield, Dale H., Carol Besterfield-Micha, Glen Besterfield, and Mary Besterfield-Sacre. *Total Quality Management*, 3rd ed. Upper Saddle River, NJ: Prentice Hall, 2011.
- Brassard, Michael, and Diane Ritter. *The Memory Jogger II: A Pocket Guide of Tools for Continuous Improvement and Effective Planning*. Methuen, MA: Goal/QPC, 1994.
- Butman, John. *Juran: A Lifetime of Influence*. New York: John Wiley & Sons, 1997.
- El-Haik, Basem, and David M. Roy. *Service Design for Six Sigma: A Roadmap for Excellence*. Hoboken, NJ: John Wiley and Sons, 2005.
- Garvin, David A. *Managing Quality*. New York: Free Press, 1988.
- Goetsch, David L., and Stanley B. Davis. *Quality Management for Organizational Excellence: Introduction to Total Quality Management*, 6th ed. Upper Saddle River, NJ: Prentice Hall, 2010.
- Gygi, Craig, Neil DeCarlo, and Bruce Williams. *Six Sigma for Dummies*, 2nd ed. Hoboken, NJ: John Wiley and Sons, 2012.
- Scherkenbach, W. W. *The Deming Route to Quality and Productivity: Roadmaps and Roadblocks*. Rockville, MD: Mercury Press/Fairchild Publications, 1990.
- Snee, Ronald D., and Roger W. Hoerl. *Six Sigma beyond the Factory Floor: Deployment Strategies for Financial Services, Health Care, and the Rest of the Real Economy*. Upper Saddle River, NJ: Pearson/Prentice Hall, 2005.
- Stevenson, William J. "Supercharging Your Pareto Analysis." *Quality Progress*. October 2000, pp. 51–55.
- Summers, Donna. *Quality*, 5th ed. Upper Saddle River, NJ: Prentice Hall, 2010.
- Trusko, Brett, Carolyn Pexton, Jim Harrington, and Praveen Gupta. *Improving Healthcare Quality and Cost with Six Sigma*. FT Press, 2007.



10 Quality Control

CHAPTER

LEARNING OBJECTIVES

After completing this chapter, you should be able to:

- LO10.1** Explain the need for quality control.
- LO10.2** Discuss the basic issues of inspection.
- LO10.3** List and briefly explain the elements of the control process.
- LO10.4** Explain how control charts are used to monitor a process and the concepts that underlie their use.
- LO10.5** Use and interpret control charts.
- LO10.6** Perform run tests to check for nonrandomness in process output.
- LO10.7** Assess process capability.

CHAPTER OUTLINE

- 10.1 Introduction** 419
- 10.2 Inspection** 420
 - How Much to Inspect and How Often 421
 - Where to Inspect in the Process 422
 - Off-Site versus On-Site Inspection 424
- 10.3 Statistical Process Control** 425
 - Process Variability 425
 - Sampling and Sampling Distributions 425
 - The Control Process 427
 - Control Charts: The Voice of the Process 428
 - Control Charts for Variables 430
 - Control Charts for Attributes 434
 - Managerial Considerations Concerning Control Charts 437
 - Run Tests 438
 - Using Control Charts and Run Tests Together 442
 - What Happens When a Process Exhibits Possible Nonrandom Variation? 443
- 10.4 Process Capability** 443
 - Capability Analysis 444
 - C_p 445
 - C_{pk} 446
 - Improving Process Capability 447
 - Taguchi Loss Function 447
 - Limitations of Capability Indexes 447
- 10.5 Operations Strategy** 448
 - Cases:** Toys, Inc. 462
 - Tiger Tools 462



Gabriela Maj/Bloomberg/Getty Images

This chapter covers quality control. The purpose of quality control is to assure that processes are performing in an acceptable manner. Companies accomplish this by monitoring process output using statistical techniques.

Quality control is a process that measures output relative to a standard and takes corrective action when output does not meet standards. If the results are acceptable, no further action is required; unacceptable results call for corrective action.

Every process generates output that exhibits random variability. That is natural and cannot be corrected. However, if there are nonrandom variations in process output, that can be corrected. Quality control tools are used to decide when corrective action is needed.

Quality control A process that evaluates output relative to a standard and takes corrective action when output doesn't meet standards.

10.1 INTRODUCTION

Quality assurance that relies primarily on inspection of lots (batches) of previously produced items is referred to as *acceptance sampling*. It is described in the chapter supplement which is on the book's website. Quality control efforts that occur during production are referred to as *statistical process control*, and these we examine in the following sections.

The best companies emphasize *designing quality into the process*, thereby greatly reducing the need for inspection or control efforts. As you might expect, different business organizations

LO10.1 Explain the need for quality control.

FIGURE 10.1

Approaches to quality assurance

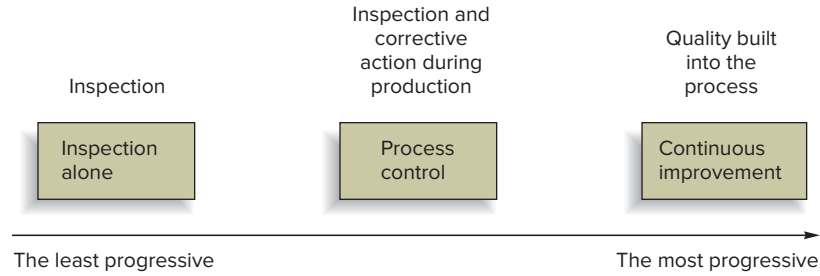

are in different stages of this evolutionary process: Some rely heavily on inspection. However, inspection alone is generally not sufficient to achieve a reasonable level of quality. Many occupy a middle ground that involves some inspection and a great deal of process control. Figure 10.1 illustrates these phases of quality assurance.

10.2 INSPECTION

Inspection Appraisal of goods or services.

Inspection is an appraisal activity that compares goods or services to a standard. Inspection is a vital but often unappreciated aspect of quality control. Although for well-designed processes little inspection is necessary, inspection cannot be completely eliminated. And with increased outsourcing of products and services, inspection has taken on a new level of significance. In lean organizations, inspection is less of an issue than it is for other organizations because lean organizations place extra emphasis on quality in the design of both products and processes. Moreover, in lean operations, workers are responsible for quality (quality at the source). However, many organizations do not operate in a lean mode, so inspection is important for them. This is particularly true of service operations, where quality continues to be a challenge for management.

Inspection can occur at three points: before production, during production, and after production. The logic of checking conformance before production is to make sure that inputs are acceptable. The logic of checking conformance during production is to make sure the conversion of inputs into outputs is proceeding in an acceptable manner. The logic of checking conformance of output is to make a final verification of conformance before passing goods on to customers.

Inspection before and after production often involves *acceptance sampling* procedures; monitoring during the production process is referred to as *process control*. Figure 10.2 gives an overview of where these two procedures are applied in the production process.

To determine whether a process is functioning as intended or to verify that a batch or lot of raw materials or final products does not contain more than a specified percentage of defective goods, it is necessary to physically examine at least some of the items in question. The purpose of inspection is to provide information on the degree to which items conform to a standard. The basic issues are:

- How much to inspect and how often
- At what points in the process inspection should occur
- Whether to inspect in a centralized or on-site location
- Whether to inspect attributes (i.e., *count* the number of times something occurs) or variables (i.e., *measure* the value of a characteristic)

FIGURE 10.2

Acceptance sampling and process control





SAM YEHL/AFP/Getty Images

A Toyota technician prepares to remove the accelerator assembly in a recalled Toyota Avalon.

Consider, for example, inspection at an intermediate step in the manufacture of laptop computers. Because inspection costs are often significant, questions naturally arise about whether one needs to inspect every computer or whether a small sample of computers will suffice. Moreover, although inspections could be made at numerous points in the production process, it is not generally cost-effective to make inspections at every point. Hence, the question comes up of which point(s) should be designated for inspections. Once the point(s) have been identified, a manager must decide whether to remove the computers from the line and take them to a lab, where specialized equipment might be available to perform certain tests, or to test them where they are being made. We will examine these options in the following sections.

How Much to Inspect and How Often

The amount of inspection can range from no inspection whatsoever to inspection of each item numerous times. Low-cost, high-volume items such as paper clips, roofing nails, and wooden pencils often require little inspection because (1) the cost associated with passing defective items is quite low and (2) the processes that produce these items are usually highly reliable, so defects are rare. Conversely, high-cost, low-volume items that have large costs associated with passing defective products often require more intensive inspections. Thus, critical components of a manned-flight space vehicle are closely scrutinized because of the risk to human safety and the high cost of mission failure. In high-volume systems, *automated* inspection is one option that may be employed.

The majority of quality control applications lie somewhere between the two extremes. Most require some inspection, but it is neither possible nor economically feasible to critically examine every part of a product or every aspect of a service for control purposes. The cost of inspection, resulting in interruptions of a process or delays caused by inspection, and the manner of testing, typically outweigh the benefits of 100 percent inspection, unless automatic inspection with sensors or cameras is possible and cost effective. Note that for manual inspection, even 100 percent inspection does not guarantee that all defects will be found and removed. Inspection is a process, and hence, subject to variation. Boredom and fatigue are factors that cause inspection mistakes. Moreover, when destructive testing is involved (items are destroyed by testing), that must be taken into account. However, the cost of letting undetected defects slip through is sufficiently high enough that inspection cannot be completely ignored.

FIGURE 10.3

Traditional view: The amount of inspection is optimal when the sum of the costs of inspection and passing defectives is minimized

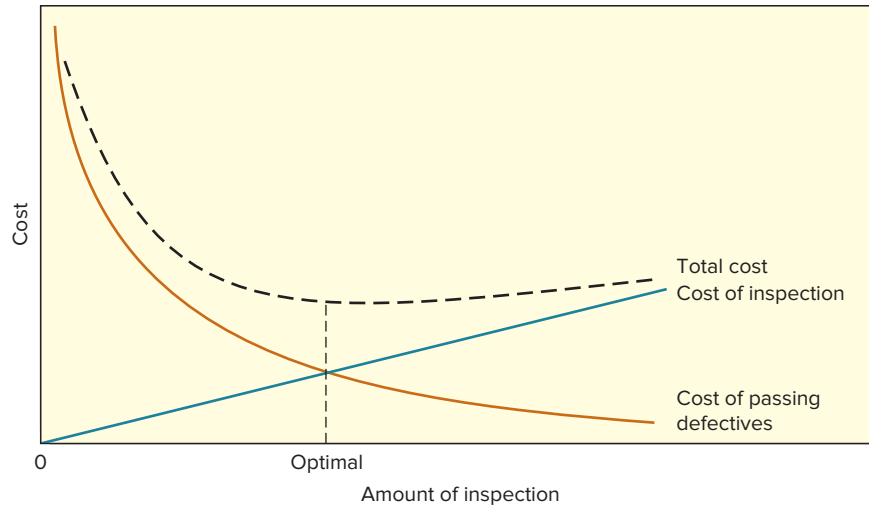

The amount of inspection needed is governed by the costs of inspection and the expected costs of passing defective items. As illustrated in Figure 10.3, if inspection activities increase, inspection costs increase, but the costs of undetected defects decrease. The traditional goal was to minimize the sum of these two costs. In other words, it may not pay to attempt to catch every defect, particularly if the cost of inspection exceeds the penalties associated with letting some defects get through. Every reduction in defective output reduces costs and increases customer satisfaction.

As a rule, operations with a high proportion of human involvement necessitate more inspection effort than mechanical operations, which tend to be more reliable.

The frequency of inspection depends largely on the rate at which a process may go out of control or on the number of lots being inspected. A stable process will require only infrequent checks, whereas an unstable one or one that has recently given trouble will require more frequent checks. Likewise, many small lots will require more samples than a few large lots because it is important to obtain sample data from each lot. For high-volume, repetitive operations, computerized automatic inspections at critical points in a process are cost-effective.

Where to Inspect in the Process

Many operations have numerous possible inspection points. Because each inspection adds to the cost of the product or service, it is important to restrict inspection efforts to the points where they can do the most good. In manufacturing, some of the typical inspection points are:

- **Raw materials and purchased parts.** There is little sense in paying for goods that do not meet quality standards and in expending time and effort on material that is bad to begin with. Supplier certification programs can reduce or eliminate the need for inspection.
- **Finished products.** Customer satisfaction and the firm's image are at stake here, and repairing or replacing products in the field is usually much more costly than doing it at the factory. Likewise, the seller is usually responsible for shipping costs on returns, and payments for goods or service may be held up pending delivery of satisfactory goods or remedial service. Well-designed processes, products and services, quality at the source, and process monitoring can reduce or eliminate the need for inspection.
- **Before a costly operation.** The point is to not waste costly labor or machine time on items that are already defective.
- **Before an irreversible process.** In many cases, items can be reworked up to a certain point; beyond that point they cannot. For example, pottery can be reworked prior to firing. After that, defective pottery must be discarded or sold as seconds at a lower price.
- **Before a covering process.** Painting, plating, and assemblies often mask defects.

Inspection can be used as part of an effort to improve process yield. One measure of process yield is the ratio of output of good product to the total output. Inspection at key points can help guide process improvement efforts to reduce the scrap rate and improve the overall process yield, and reduce or eliminate the need for inspection.

In the service sector, inspection points are incoming purchased materials and supplies, personnel, service interfaces (e.g., service counter), and outgoing completed work (e.g., repaired appliances). Table 10.1 illustrates a number of examples.

Type of Business	Inspection Points	Characteristics
Fast food	Cashier	Accuracy
	Counter area	Appearance, productivity
	Eating area	Cleanliness, no loitering
	Building and grounds	Appearance, safety hazards
	Kitchen	Cleanliness, purity of food, food storage, health regulations
	Parking lot	Safety, good lighting
Hotel/motel	Accounting/billing	Accuracy, timeliness
	Building and grounds	Appearance and safety
	Main desk	Appearance, waiting times, accuracy of bills
	Maid service	Completeness, productivity
	Personnel	Appearance, manners, productivity
	Reservations/occupancy	Over/underbooking, percent occupancy
	Restaurants	Kitchen, menus, meals, bills
	Room service	Waiting time, quality of food
Supermarket	Supplies	Ordering, receiving, inventories
	Cashiers	Accuracy, courtesy, productivity
	Deliveries	Quality, quantity
	Produce	Freshness, ample stock
	Aisles and stockrooms	Uncluttered layout
	Inventory control	Stock-outs
	Shelf stock	Ample supply, rotation of perishables
	Shelf displays	Appearance
	Checkouts	Waiting time
	Shopping carts	Good working condition, ample supply, theft/vandalism
	Parking lot	Safety, good lighting
Doctor's office	Personnel	Appearance, productivity
	Waiting room	Appearance, comfortable
	Examination room	Clean, temperature controlled
	Doctor	Neat, friendly, concerned, skillful, knowledgeable
	Doctor's assistant	Neat, friendly, concerned, skillful
	Patient records	Accurate, up-to-date
	Billing	Accurate
Other	Waiting time minimal, adequate time with doctor	

TABLE 10.1

Examples of inspection points in service organizations



FALSIFIED INSPECTION REPORTS CREATE MAJOR RISKS AND JOB LOSSES

Federal authorities accused an employee of an upstate New York firm of forging signatures on inspection reports. The man in question was an employee of PMI, an aerospace precision manufacturer, specializing in high-tolerance machining for mission critical parts used by SpaceX and other contractors to build space flight vehicles. He worked as a quality assurance engineer. He allegedly falsified 38 inspection reports, saying the parts had been inspected when they hadn't. At least 76 parts used to manufacture the Falcon 9 and Falcon Heavy series of space flight vehicles were involved. If some of the uninspected parts were to malfunction, "it could result in catastrophic failure of the mission," according to the complaint. Such an occurrence could jeopardize years of work and result in millions of dollars of losses.

Shortly after federal authorities announced the man's arrest, SpaceX terminated its contract with PMI, and before long, the company ceased operations, leaving 35 workers without jobs.

Based on: Will Cleveland, "Penn Yan man put SpaceX rockets in jeopardy by forging inspection reports, feds allege." *Rochester Democrat and Chronicle*, USA Today Network, pp. 4–5, May 24, 2019.

Questions

1. What steps could a company take to reduce the probability of false inspection reports?
2. Although apparently no issues occurred with the parts that were shipped to SpaceX, if there had been failures, how "catastrophic" might the outcomes have been?

Off-Site versus On-Site Inspection

Some situations require that inspections be performed *on site*. For example, inspecting the hull of a ship for cracks requires inspectors to visit the ship. At other times, specialized tests can best be performed in a lab (e.g., performing medical tests, analyzing food samples, testing metals for hardness, running viscosity tests on lubricants).

The central issue in the decision concerning on-site or lab inspections is whether the advantages of specialized lab tests are worth the time and interruption needed to obtain the results. Reasons favoring on-site inspection include quicker decisions and avoidance of introduction of extraneous factors (e.g., damage or other alteration of samples during transportation to the lab). On the other hand, specialized equipment and a more favorable test environment

A Mattel technician in China does a pulling test with a Dora the Explorer doll in the name of product safety. Mattel has 10 labs in six countries and has set up strict requirements for vendors because of safety recalls.



Chang W. Lee/The New York Times/Redux

(less noise and confusion, lack of vibrations, absence of dust, and no workers “helping” with inspections) offer strong arguments for using a lab.

Some companies rely on self-inspections by operators if errors can be traced back to specific operators. This places responsibility for errors at their source (*quality at the source*).

10.3 STATISTICAL PROCESS CONTROL

Quality control is concerned with the **quality of conformance** of a process: Does the output of a process conform to the intent of design? Variations in characteristics of process output provide the rationale for process control. **Statistical process control (SPC)** is used to evaluate process output to decide if a process is “in control” or if corrective action is needed.

Quality of conformance A product or service conforms to specifications.

Statistical process control (SPC) Statistical evaluation of the output of a process.

Process Variability

All processes generate output that exhibits some degree of variability. The issue is whether the output variations are within an acceptable range. The issue is addressed by answering two basic questions about the process variations:

- *Are the variations random?* If nonrandom variations are present, the process is considered to be unstable. Corrective action will need to be taken to improve the process by eliminating the causes of nonrandomness to achieve a stable process.
- *Given a stable process, is the inherent variability of process output within a range that conforms to performance criteria?* This involves assessment of a process’s capability to meet standards. If a process is not capable, that situation will need to be addressed.

The natural or inherent process variations in process output are referred to as *chance* or **random variations**. Such variations are due to the combined influences of countless minor factors, each one so unimportant that even if it could be eliminated, the impact on process variations would be negligible. In Deming’s terms, this is referred to as *common variability*. The amount of inherent variability differs from process to process. For instance, older machines generally exhibit a higher degree of natural variability than newer machines, partly because of worn parts and partly because new machines may incorporate design improvements that lessen the variability in their output.

Random variation Natural variation in the output of a process, created by countless minor factors.

A second kind of variability in process output is called **assignable variation**, or *non-random variation*. In Deming’s terms, this is referred to as *special variation*. Unlike natural variation, the main sources of assignable variation can usually be identified (assigned to a specific cause) and eliminated. Tool wear, equipment that needs adjustment, defective materials, human factors (carelessness, fatigue, noise and other distractions, failure to follow correct procedures, and so on), and problems with measuring devices are typical sources of assignable variation.

Assignable variation In process output, a variation whose cause can be identified. A nonrandom variation.

Sampling and Sampling Distributions

In statistical process control, periodic samples of process output are taken, and sample statistics, such as sample means or the number of occurrences of a certain type of outcome, are determined. The sample statistics can be used to judge randomness of process variations. The sample statistics exhibit variation, just as processes do. The variability of sample statistics can be described by its **sampling distribution**, a theoretical distribution that describes the *random* variability of sample statistics. For a variety of reasons, the most frequently used distribution is the normal distribution.

Sampling distribution A theoretical distribution of sample statistics.

Figure 10.4A illustrates a sampling distribution and a process distribution (i.e., the distribution of process variations). Note three important things in Figure 10.4A: (1) both distributions have the same mean; (2) the variability of the sampling distribution is less than the variability of the process; and (3) the sampling distribution is normal. This is true even if the process distribution is not normal as long as the sample size isn’t very small.

FIGURE 10.4A The sampling distribution of means is normal, and it has less variability than the process distribution, which might not be normal

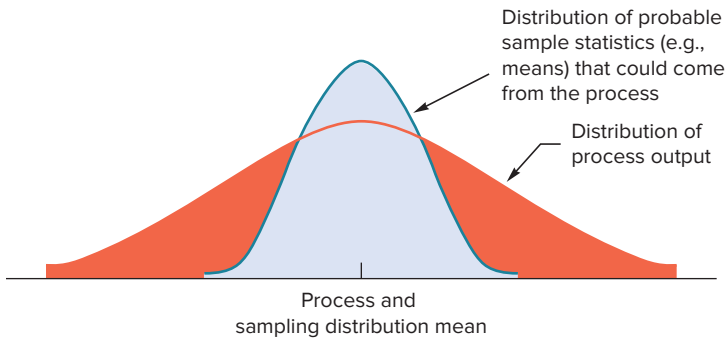
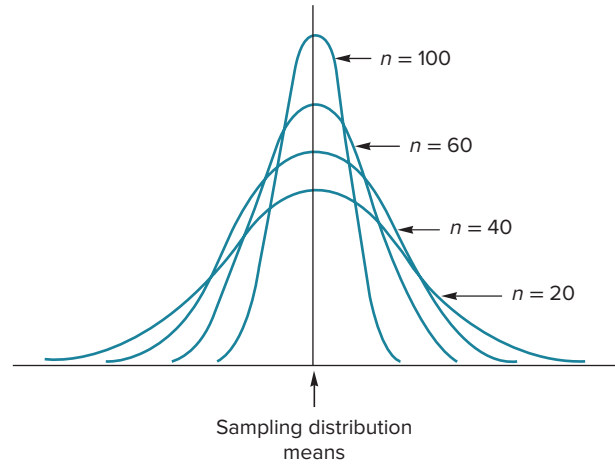

FIGURE 10.4B The larger the sample size, the narrower the sampling distribution



Central limit theorem The distribution of sample averages tends to be normal regardless of the shape of the process distribution.

In the case of sample means, the **central limit theorem** states that as the sample size increases, the distribution of sample averages approaches a normal distribution regardless of the shape of the sampled population. This tends to be the case even for fairly small sample sizes. For other sample statistics, the normal distribution serves as a reasonable approximation to the shape of the actual sampling distribution.

Figure 10.4B illustrates what happens to the shape of the sampling distribution relative to the sample size. The larger the sample size, the narrower the sampling distribution. This means that the likelihood that a sample statistic is close to the true value in the population is higher for large samples than for small samples.

A sampling distribution serves as the theoretical basis for distinguishing between random and nonrandom values of a sampling statistic. Very simply, limits are selected within which most values of a sample statistic should fall if its variations are random. The limits are stated in terms of number of standard deviations from the distribution mean. Typical limits are ± 2 standard deviations or ± 3 standard deviations. Figure 10.5 illustrates these possible limits and the probability that a sample statistic would fall within those limits if only random variations are present. Conversely, if the value of a sample statistic falls outside those limits, there is only a small probability ($1 - 99.74 = .0026$ for ± 3 limits, and $1 - 95.44 = .0456$ for ± 2 limits) that the value reflects randomness. Instead, such a value would suggest nonrandomness.

LO10.3 List and briefly explain the elements of the control process.

The Control Process

Sampling and corrective action are only a part of the control process. Effective control requires the following steps:

Define. The first step is to define in sufficient detail what is to be controlled. It is not enough, for example, to simply refer to a painted surface. The paint can have a number

FIGURE 10.5 Percentage of values within given ranges in a normal distribution

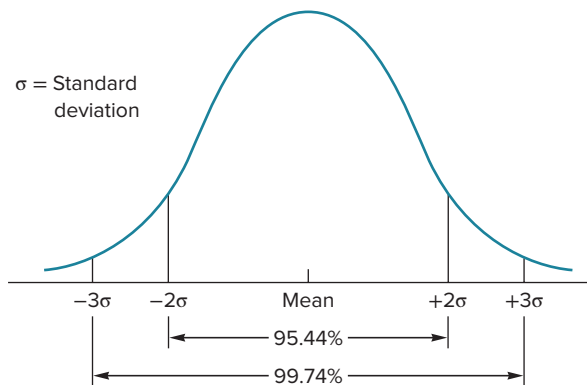

of important characteristics, such as its thickness, hardness, and resistance to fading or chipping. Different characteristics may require different approaches for control purposes.

Measure. Only those characteristics that can be counted or measured are candidates for control. Thus, it is important to consider how measurement will be accomplished.

Compare. There must be a standard of comparison that can be used to evaluate the measurements. This will relate to the level of quality being sought.

Evaluate. Management must establish a definition of *out of control*. Even a process that is functioning as it should will not yield output that conforms exactly to a standard, simply because of the natural (i.e., random) variations inherent in all processes, manual or mechanical—a certain amount of variation is inevitable. The main task of quality control is to distinguish random from *nonrandom* variability, because nonrandom variability means that a process is out of control.

Correct. When a process is judged to be out of control, corrective action must be taken. This involves uncovering the cause of nonrandom variability (e.g., worn equipment, incorrect methods, failure to follow specified procedures) and correcting it.

Monitor results. To ensure that corrective action is effective, the output of a process must be monitored for a sufficient period of time to verify that the problem has been eliminated.

In sum, control is achieved by checking a portion of the goods or services, comparing the results to a predetermined standard, evaluating departures from the standard, taking corrective action when necessary, and following up to ensure that problems have been corrected.



Checking for burned or deformed chips.

Control Charts: The Voice of the Process

Control chart A visual tool for monitoring forecast errors.

LO10.4 Explain how control charts are used to monitor a process and the concepts that underlie their use.

An important tool in statistical process control is the control chart, which was developed by Walter Shewhart. A **control chart** is a *time-ordered* plot of sample statistics (e.g., sample means). It is used to monitor sample statistics (e.g., sample means) to determine if the variability exhibited reflects random variation. It has upper and lower limits, called *control limits*, that define the range of acceptable (i.e., random) variation for the sample statistic. A control chart is illustrated in Figure 10.6. The purpose of a control chart is to determine if there are nonrandom variations in the sample statistics. A necessary (but not sufficient) condition for a process to be deemed “in control,” or stable, is for all the data points to fall between the upper and lower control limits. Conversely, a data point that falls on or outside of either limit would be taken as evidence that the process output may be nonrandom and, therefore, not “in control.” If that happens, the process would be halted to find and correct the cause of the nonrandom variation. The essence of statistical process control is to assure that the output of a process is random so that *future output* will be random.

The basis for the control chart is the sampling distribution, which essentially describes random variability. There is, however, one minor difficulty relating to the use of a normal sampling distribution. The theoretical distribution extends in either direction to *infinity*. Therefore, *any* value is theoretically possible, even one that is a considerable distance from the mean of the distribution. However, as a practical matter, we know that, say, 99.7 percent of the values will be within ± 3 standard deviations of the mean of the distribution. Therefore, we could decide to set the limit, so to speak, at values that represent ± 3 standard deviations from the mean, and conclude that any value that was farther away than these limits was a nonrandom variation.

Control limits The dividing lines between random and nonrandom deviations from the mean of the distribution.

In effect, these limits are **control limits**: the dividing lines between what will be designated as random deviations from the mean of the distribution and what will be designated as nonrandom deviations from the mean of the distribution. Figure 10.7 illustrates how control limits are based on the sampling distribution.

Control charts have two limits that separate random variation and nonrandom variation. The larger value is the *upper control limit* (UCL), and the smaller value is the *lower control limit* (LCL). A sample statistic that falls between these two limits suggests (but does not prove) randomness, while a value outside or on either limit suggests (but does not prove) nonrandomness.

FIGURE 10.6
Example of a control chart

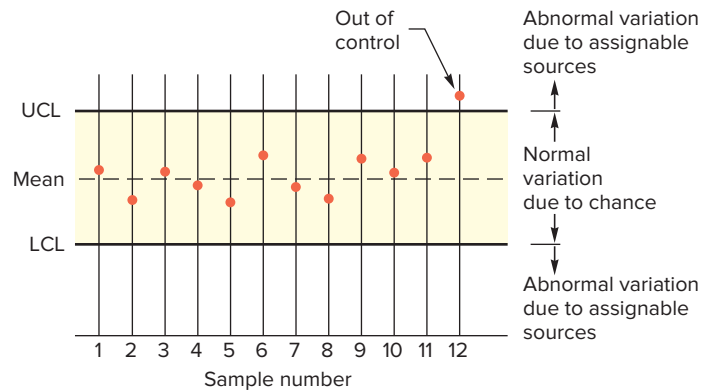
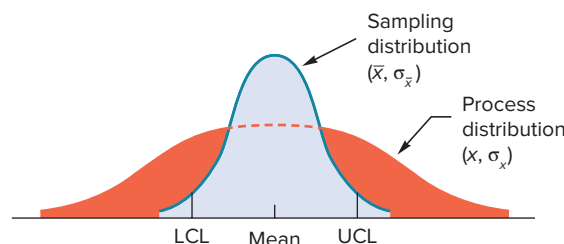

FIGURE 10.7
Control limits are based on the sampling distribution



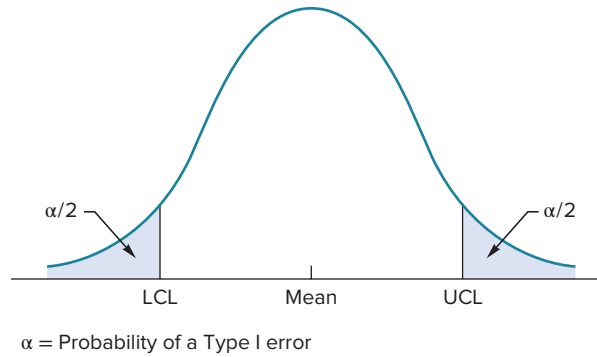

FIGURE 10.8

The probability of a Type I error

It is important to recognize that because any limits will leave some area in the *tails* of the distribution, there is a small probability that a value will fall outside the limits *even though only random variations are present*. For example, if ± 2 sigma (standard deviation) limits are used, they would include 95.5 percent of the values. Consequently, the complement of that number (100 percent = 95.5 percent = 4.5 percent) would not be included. That percentage (or *probability*) is sometimes referred to as the probability of a **Type I error**, where the “error” is concluding that nonrandomness is present when only randomness is present. It is also referred to as an *alpha risk*, where alpha (α) is the sum of the probabilities in the two tails. Figure 10.8 illustrates this concept.

Type I error Concluding a process is not in control when it actually is.

Using wider limits (e.g., ± 3 sigma limits) reduces the probability of a Type I error because it decreases the area in the tails. However, wider limits make it more difficult to detect nonrandom variations *if they are present*. For example, the mean of the process might shift (an assignable cause of variation) enough to be detected by two-sigma limits, but not enough to be readily apparent using three-sigma limits. That could lead to a second kind of error, known as a **Type II error**, which is concluding that a process is in control when it is really out of control (i.e., concluding nonrandom variations are not present, when they are). In theory, the costs of making each error should be balanced by their probabilities. However, in practice, two-sigma limits and three-sigma limits are commonly used without specifically referring to the probability of a Type II error.

Type II error Concluding a process is in control when it is not.

Table 10.2 illustrates how Type I and Type II errors occur.

Each sample is represented by a single value (e.g., the sample mean) on a control chart. Moreover, each value is compared to the extremes of the sampling distribution (the control limits) to judge if it is within the acceptable (random) range. Figure 10.9 illustrates this concept.

		And the conclusion is that it is:	
		In Control	Out of Control
If a process is actually:	In control	No error	Type I error (producer’s risk)
	Out of control	Type II error (consumer’s risk)	No error

TABLE 10.2

Type I and Type II errors

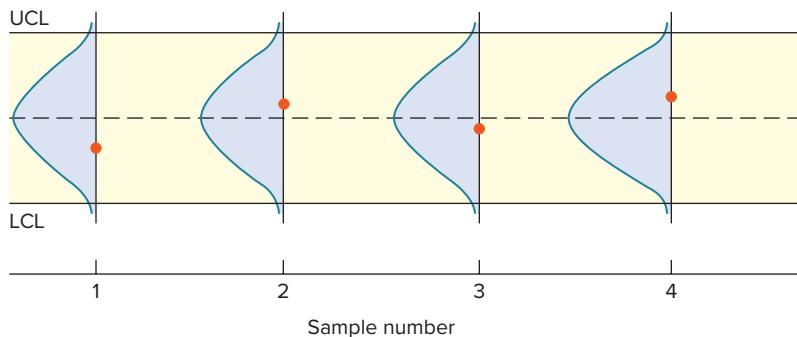

FIGURE 10.9

Each observation is compared to the selected limits of the sampling distribution

Variables Generate data that are *measured*.

Attributes Generate data that are *counted*.

There are four commonly used control charts. Two are used for **variables**, and two are used for **attributes**. Attribute data are *counted* (e.g., the number of defective parts in a sample, the number of calls per day); variables data are *measured*, usually on a continuous scale (e.g., amount of time needed to complete a task, length or width of a part).

The two control charts for variables data are described in the next section, and the two control charts for attribute data are described in the section following that.

Control Charts for Variables

Mean and range charts are used to monitor variables. Control charts for means monitor the *central tendency* of a process, and range charts monitor the *dispersion* of a process.

Mean control chart Control chart used to monitor the central tendency of a process.

Mean Charts. A **mean control chart**, sometimes referred to as an \bar{x} (“x-bar”) chart, is based on a normal distribution. It can be constructed in one of two ways. The choice depends on what information is available. Although the value of the standard deviation of a process, σ , is often unknown, if a reasonable estimate is available, one can compute control limits using these formulas:

$$\begin{aligned}\text{Upper control limit (UCL)} &= \bar{\bar{x}} + z\sigma_{\bar{x}} \\ \text{Lower control limit (LCL)} &= \bar{\bar{x}} - z\sigma_{\bar{x}}\end{aligned}\quad (10-1)$$

where

$$\sigma_{\bar{x}} = \sigma/\sqrt{n}$$

$\sigma_{\bar{x}}$ = Standard deviation of distribution of sample means

σ = Estimate of the process standard deviation

n = Sample size

z = The number of standard deviations that control limits are based on

$\bar{\bar{x}}$ = Average of sample means

The following example illustrates the use of these formulas.

EXAMPLE 1

Excel

mhhe.com/stevenson14e

Determining Control Limits for Means

A quality inspector took five samples ($k = 5$), each with four observations ($n = 4$), of the length of time for glue to dry. The analyst computed the mean of each sample and then computed the grand mean. All values are in minutes. Use this information to obtain three-sigma (i.e., $z = 3$) control limits for means of future times. It is known from previous experience that the standard deviation of the process is .02 minute.

		SAMPLE				
		1	2	3	4	5
Observation	1	12.11	12.15	12.09	12.12	12.09
	2	12.10	12.12	12.09	12.10	12.14
	3	12.11	12.10	12.11	12.08	12.13
	4	12.08	12.11	12.15	12.10	12.12
	\bar{x}	12.10	12.12	12.11	12.10	12.12

SOLUTION

$$\bar{\bar{x}} = \frac{12.10 + 12.12 + 12.11 + 12.10 + 12.12}{5} = 12.11$$

Using Formula 10-1, with $z = 3$, $n = 4$ observations per sample, and $\sigma = .02$, we find

$$\text{UCL: } 12.11 + 3\left(\frac{.02}{\sqrt{4}}\right) = 12.14$$

$$\text{LCL: } 12.11 - 3\left(\frac{.02}{\sqrt{4}}\right) = 12.08$$

Note: If one applied these control limits to the means, one would judge the process to be *in control* because all of the sample means have values that fall within the control limits. The fact that some of the *individual* measurements fall outside of the control limits (e.g., the first observation in Sample 2 and the last observation in Sample 3) is irrelevant. You can see why by referring to Figure 10.7: *Individual* values are represented by the process distribution, a large portion of which lies outside of the control limits for *means*.

This and similar problems can also be solved using the Excel templates available on the book’s website. The solution for Example 1 using Excel is shown next.

Mean Control Chart (σ known)

[<Back](#)

Basic

Clear

Average of sample means		12.11
Process standard deviation	σ =	0.02
Sample size	n =	4
	z =	3
	Δz =	0.1

UCL =	12.14
LCL =	12.08

Calculations:

	Mean
Average	12.11

Sample	Mean
1	12.1
2	12.12
3	12.11
4	12.1
5	12.12
6	

Source: Microsoft

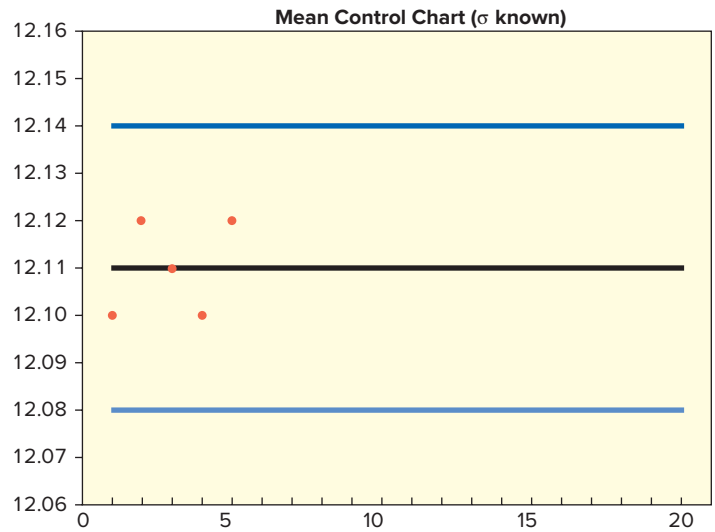

Note: To display more data on the above graph, right-click on the x-axis, select Format Axis, and set Maximum to a higher value. The size of the graph may also be increased.

If an observation on a control chart is on or outside of either control limit, the process is stopped to investigate the cause of that value, such as operator error, machine out of adjustment, or similar assignable cause of variation. If no source of error is found, the value could simply be due to chance, and the process will be restarted. However, the output should then be monitored to see if additional values occur that are beyond the control limits, in which case a more thorough investigation would be needed to uncover the source of the problem so it can be corrected.

If the standard deviation of the process is unknown, another approach is to use the sample *range* as a measure of process variability. The appropriate formulas for control limits are

$$\begin{aligned} \text{UCL} &= \bar{\bar{x}} + A_2\bar{R} \\ \text{LCL} &= \bar{\bar{x}} - A_2\bar{R} \end{aligned} \tag{10-2}$$

where

A_2 = A factor from Table 10.3

\bar{R} = Average of sample ranges

LO10.5 Use and interpret control charts.

Using Table 10.3 to Compute Control Limits for Means

Refer to the data given in Example 1. In order to use Formula 10–2, we need to compute the grand mean for the data and the average sample range. In Example 1, the grand mean is 12.11. The range for each sample is the difference between the largest and smallest sample values. For the first sample, the largest value is 12.11 and the smallest value is 12.08. The range is the difference between these two values, which is $12.11 - 12.08 = .03$. For the second sample, the range is $12.15 - 12.10 = 0.05$. The other ranges can be computed in similar fashion. The average range is:

$$\bar{R} = (.03 + .05 + .06 + .04 + .05)/5 = .046$$

EXAMPLE 2

excel
mhhe.com/stevenson14e

SOLUTION

$\bar{x} = 12.11$, $\bar{R} = .046$, and $A_2 = .73$ for $n = 4$ (from Table 10.3). Using Formula 10–2, we can compute the upper and lower limits for a mean control chart:

$$UCL = 12.11 + .73(.046) = 12.14 \text{ minutes}$$

$$LCL = 12.11 - .73(.046) = 12.08 \text{ minutes}$$

Except for rounding, these results are the same as those computed in Example 1. Usually that will be the case, but not always.

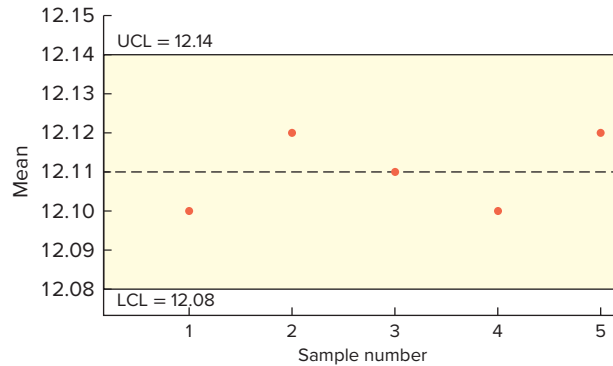

Range control chart Control chart used to monitor process dispersion.

Range Charts. Range control charts (R -charts) are used to monitor process dispersion; they are sensitive to changes in process dispersion. Although the underlying sampling distribution is not normal, the concepts for the use of range charts are much the same as those for the use of mean charts. Control limits for range charts are found using the average sample range in conjunction with these formulas:

$$UCL = D_4 \bar{R}$$

$$LCL = D_3 \bar{R}$$

(10–3)

where values of D_3 and D_4 are obtained from Table 10.3.¹

EXAMPLE 3**Using Table 10.3 to Compute Control Limits for Ranges****eXcel**

mhhe.com/stevenson14e

Using the average range found in Example 2 and Formula 10–3, we can compute the control limits for a range chart.

SOLUTION

From Table 10.3, for $n = 4$, $D_4 = 2.28$, and $D_3 = 0$. Thus,

$$UCL = 2.28(.046) = .105 \text{ minutes}$$

$$LCL = 0(.046) = 0 \text{ minutes}$$

Note that the five sample ranges shown in Example 2 are within these control limits.

Using Mean and Range Charts. Mean control charts and range control charts provide different perspectives on a process. As we have seen, mean charts are sensitive to shifts in the process mean, whereas range charts are sensitive to changes in process dispersion. Because of this difference in perspective, both types of charts might be used to monitor the same process. The logic of using both is readily apparent in Figure 10.10. In Figure 10.10A, the mean chart picks up the shift in the process mean, but because the dispersion is not changing, the range chart fails to indicate a problem. Conversely, in Figure 10.10B, a change in process dispersion is less apt

¹If the process standard deviation is known, control limits for a range chart can be calculated using values from Table 10.3:

$$LCL = \frac{3D_3\sigma}{A_2\sqrt{n}}, \quad UCL = \frac{3D_4\sigma}{A_2\sqrt{n}}$$

Number of Observations in Sample, n	FACTORS FOR R CHARTS		
	Factor for Chart, A_2	Lower Control Limit, D_3	Upper Control Limit, D_4
2	1.88	0	3.27
3	1.02	0	2.57
4	0.73	0	2.28
5	0.58	0	2.11
6	0.48	0	2.00
7	0.42	0.08	1.92
8	0.37	0.14	1.86
9	0.34	0.18	1.82
10	0.31	0.22	1.78
11	0.29	0.26	1.74
12	0.27	0.28	1.72
13	0.25	0.31	1.69
14	0.24	0.33	1.67
15	0.22	0.35	1.65
16	0.21	0.36	1.64
17	0.20	0.38	1.62
18	0.19	0.39	1.61
19	0.19	0.40	1.60
20	0.18	0.41	1.59

TABLE 10.3

Factors for three-sigma control limits for \bar{X} and R charts

Source: Adapted from Eugene Grant and Richard Leavenworth, *Statistical Quality Control*, 5th ed. 1980 McGraw-Hill Education.

to be detected by the mean chart than by the range chart. Thus, use of both charts provides more complete information than either chart alone. Even so, a single chart may suffice in some cases. For example, a process may be more susceptible to changes in the process mean than to changes in dispersion, so it might be unnecessary to monitor dispersion. Because of the time and cost of constructing control charts, gathering the necessary data, and evaluating the results, only those aspects of a process that tend to cause problems should be monitored.

Once control charts have been set up, they can serve as a basis for deciding when to interrupt a process and search for assignable causes of variation. To determine initial control limits, one can use the following procedure:

1. Obtain 20 to 25 samples. Compute the appropriate sample statistic(s) for each sample (e.g., mean).
2. Establish preliminary control limits using the formulas.
3. Determine if any points fall outside the control limits.
4. Plot the data on the control chart and check for patterns.
5. If no out-of-control signs are found, assume that the process is in control. If any out-of-control signals are found, investigate and correct causes of variation. Then, resume the process and collect another set of observations upon which control limits can be based.



Antonio/Perez/Chicago Tribune/MCT/Getty Images

Checking food taste

FIGURE 10.10

Mean and range charts used together complement each other

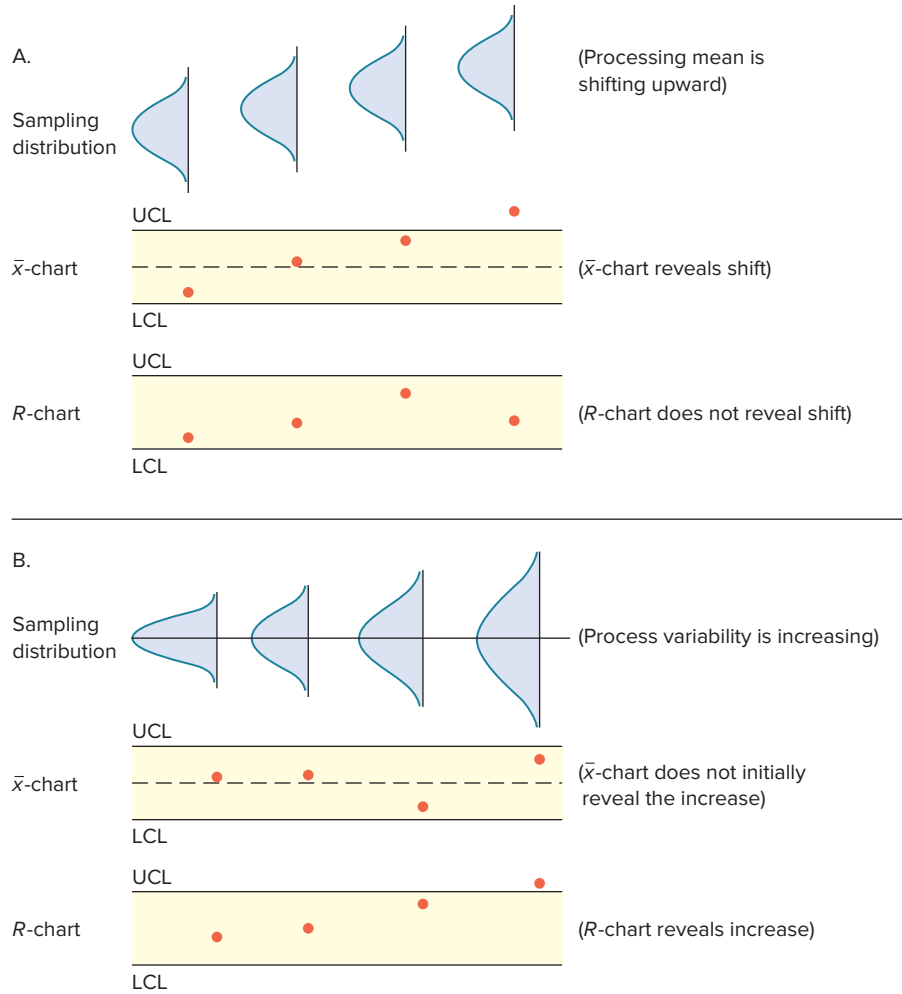

Control Charts for Attributes

Control charts for attributes are used when the process characteristic is *counted* rather than measured. For example, the number of defective items in a sample is counted, whereas the length of each item is measured. There are two types of attribute control charts, one for the fraction of defective items in a sample (a *p*-chart) and one for the number of defects per unit (a *c*-chart). A *p*-chart is appropriate when the data consist of two categories of items. For instance, if glass bottles are inspected for chipping and cracking, both the good bottles and the defective ones can be counted. However, one can count the number of accidents that occur during a given period of time but *not* the number of accidents that did not occur. Similarly, one can count the number of scratches on a polished surface, the number of bacteria present in a water sample, and the number of crimes committed during the month of August, but one cannot count the number of non-occurrences. In such cases, a *c*-chart is appropriate. See Table 10.4.

p-chart Control chart for attributes, used to monitor the proportion of defective items in a process.

p-Chart. A **p-chart** is used to monitor the proportion of defective items generated by a process. The theoretical basis for a *p*-chart is the binomial distribution, although for large sample sizes, the normal distribution provides a good approximation to it. Conceptually, a *p*-chart is constructed and used in much the same way as a mean chart.

The centerline on a *p*-chart is the average fraction defective in the population, *p*. The standard deviation of the sampling distribution when *p* is known is

$$\sigma_p = \sqrt{\frac{p(1-p)}{n}}$$

The following tips should help you select the type of control chart, a p -chart or a c -chart, that is appropriate for a particular application:

Use a p -chart:

1. When observations can be placed into one of *two* categories. Examples include items (observations) that can be classified as
 - a. Good or bad
 - b. Pass or fail
 - c. Operate or don't operate
2. When the data consist of multiple samples of n observations each (e.g., 15 samples of $n = 20$ observations each).

Use a c -chart:

- When only the number of occurrences per unit of measure can be counted; non-occurrences cannot be counted. Examples of occurrences and units of measure include
- a. Scratches, chips, dents, or errors per item
 - b. Cracks or faults per unit of distance (e.g., meters, miles)
 - c. Breaks or tears, per unit of area (e.g., square yard, square meter)
 - d. Bacteria or pollutants per unit of volume (e.g., gallon, cubic foot, cubic yard)
 - e. Calls, complaints, failures, equipment breakdowns, or crimes per unit of time (e.g., hour, day, month, year)

TABLE 10.4
 p -chart or c -chart?

Control limits are computed using the formulas

$$\begin{aligned}
 UCL_p &= p + z\sigma_p \\
 LCL_p &= p - z\sigma_p
 \end{aligned}
 \tag{10-4}$$

If p is unknown, which is generally the case, it can be estimated from samples. That estimate, \bar{p} , replaces p in the preceding formulas, and $\hat{\sigma}_p$ replaces σ_p , as illustrated in Example 4.

Note: Because the formula is an approximation, it sometimes happens that the computed LCL is negative. In those instances, zero is used as the lower limit because the proportion of defective items cannot be less than zero.

Computing Control Limits for the Fraction Defective

An inspector counted the number of defective monthly billing statements of a telephone company in each of 20 samples. Using the following information, construct a control chart that will describe 99.74 percent of the chance variation in the process when the process is in control. Each sample contained 100 statements.

EXAMPLE 4

mhhe.com/stevenson14e

Sample	Number of Defectives	Sample	Number of Defectives	Sample	Number of Defectives	Sample	Number of Defectives
1	7	6	11	11	8	16	10
2	10	7	10	12	12	17	8
3	12	8	18	13	9	18	12
4	4	9	13	14	10	19	10
5	9	10	10	15	16	20	21
							220

To find z , divide .9974 by 2 to obtain .4987, and using that value, refer to Appendix B, Table A to find $z = 3.00$.

SOLUTION

$$\bar{p} = \frac{\text{Total number of defectives}}{\text{Total number of observations}} = \frac{220}{20(100)} = .11$$

$$\hat{\sigma}_p = \sqrt{\frac{.11(1 - .11)}{100}} = 0.0313 \sqrt{\frac{\bar{p}(1 - \bar{p})}{n}}$$

Control limits are

$$UCL_p = \bar{p} + z(\hat{\sigma}_p) = .11 + 3.00(0.0313) = .2039$$

$$LCL_p = \bar{p} - z(\hat{\sigma}_p) = .11 - 3.00(0.0313) = .0161$$

Plotting the control limits and the sample fraction defective, you can see that the last value is above the upper control limit. The process would be stopped at that point to find and correct the possible cause. Then, new data would be collected to establish new control limits. However, if no cause is found, this could be due to chance. The new limits would remain, but future output would be monitored to assure the process remains in control.

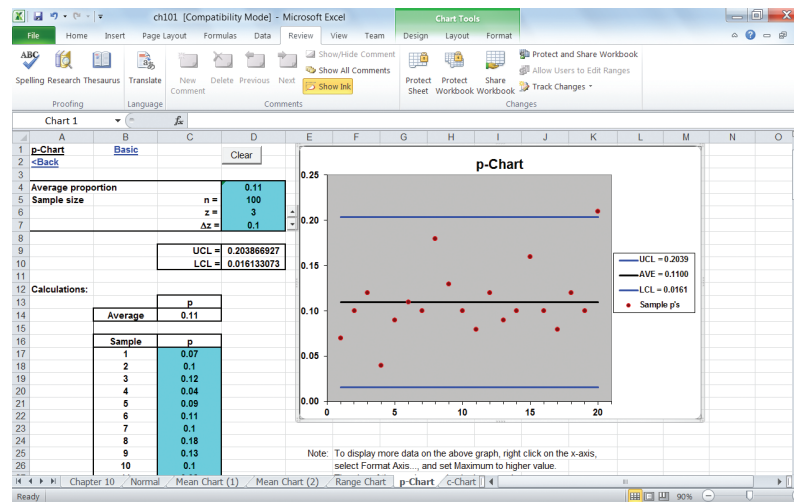
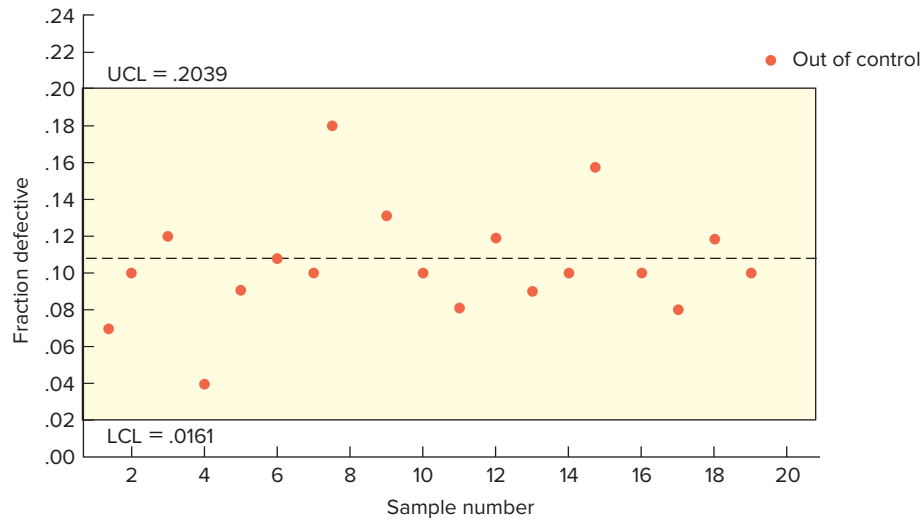

Source: Microsoft

c-chart Control chart for attributes, used to monitor the number of defects per unit.

c-Chart. When the goal is to control the number of *occurrences* (e.g., defects) *per unit*, a **c-chart** is used. Units might be automobiles, hotel rooms, typed pages, or rolls of carpet. The underlying sampling distribution is the Poisson distribution. Use of the Poisson distribution assumes that defects occur over some *continuous* region and that the probability of more than one defect at any particular point is negligible. The mean number of defects per unit is c and the standard deviation is \sqrt{c} . For practical reasons, the normal approximation to the Poisson is used. The control limits are

$$UCL_c = c + z\sqrt{c}$$

$$LCL_c = c - z\sqrt{c} \tag{10-5}$$

If the value of c is unknown, as is generally the case, the sample estimate, \bar{c} , is used in place of c , using $\bar{c} = \text{Number of defects} \div \text{Number of samples}$.

Computing Control Limits for the Number of Defects

Rolls of coiled wire are monitored using a c -chart. Eighteen rolls have been examined, and the number of defects per roll has been recorded in the following table. Is the process in control? Plot the values on a control chart using three standard deviation control limits.

EXAMPLE 5

excel
mhhe.com/stevenson14e

Sample	Number of Defectives	Sample	Number of Defectives	Sample	Number of Defectives
1	3	7	4	13	2
2	2	8	1	14	4
3	4	9	2	15	2
4	5	10	1	16	1
5	1	11	3	17	3
6	2	12	4	18	1
					<u>1</u> 45

$\bar{c} = 45/18 = 2.5 = \text{Average number of defects per coil}$

$$UCL_c = \bar{c} + 3\sqrt{\bar{c}} = 2.5 + 3\sqrt{2.5} = 7.24$$

$$LCL_c = \bar{c} - 3\sqrt{\bar{c}} = 2.5 - 3\sqrt{2.5} = -2.24 \rightarrow 0$$

SOLUTION

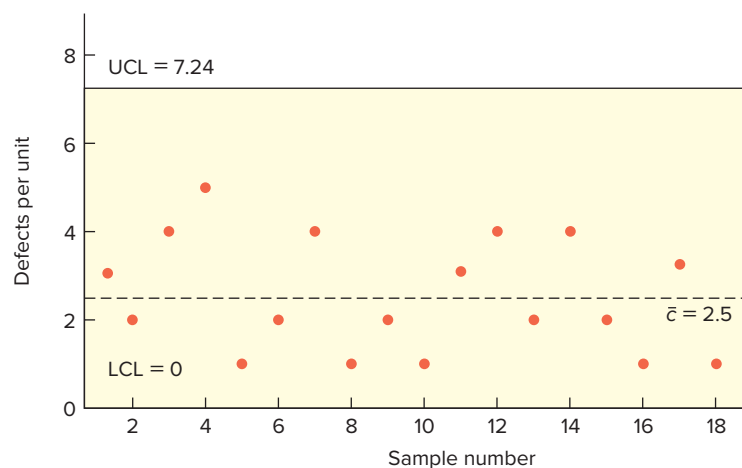

When the computed lower control limit is negative, the effective lower limit is zero. In such cases, if a control chart point is zero, it should not be deemed to be out of control. The calculation sometimes produces a negative lower limit due to the use of the normal distribution to approximate the Poisson distribution: The normal is symmetrical, whereas the Poisson is not symmetrical when c is close to zero.

Note that if an observation falls below the lower control limit on a p -chart or a c -chart, the cause should be investigated, just as it would be for a mean or range chart, even though such a point would imply that the process is exhibiting better-than-expected quality. It may turn out to be the result of an undesirable overuse of resources. On the other hand, it may lead to a discovery that can improve the quality of the process.

Managerial Considerations Concerning Control Charts

Using control charts adds to the cost and time needed to obtain output. Ideally, a process is so good that the desired level of quality could be achieved without the use of any control charts. The best organizations strive to reach this level, but many are not yet there, so they

employ control charts at various points in their processes. In those organizations, managers must make a number of important decisions about the use of control charts:

- At what points in the process to use control charts
- What size samples to take
- What type of control chart to use (i.e., variables or attribute)
- How often should samples be taken

The decision about where to use control charts should focus on those aspects of the process that (1) have a tendency to go out of control and (2) are critical to the successful operation of the product or service (i.e., variables that affect product or service characteristics).

Sample size is important for two reasons. One is that cost and time are functions of sample size; the greater the sample size, the greater the cost to inspect those items (and the greater the lost product if destructive testing is involved) and the longer the process must be held up while waiting for the results of sampling. The second reason is that smaller samples are more likely to reveal a change in the process than larger samples because a change is more likely to take place *within* the large sample than *between* small samples. Consequently, a sample statistic such as the sample mean in the large sample could combine both “before-change” and “after-change” observations, whereas in two smaller samples, the first could contain “before” observations and the second “after” observations, making detection of the change more likely.

In some instances, a manager can choose between using a control chart for variables (a mean chart) and a control chart for attributes (a p -chart). If the manager is monitoring the diameter of a drive shaft, either the diameter could be measured and a mean chart used for control, or the shafts could be inspected using a *go, no-go gauge*—which simply indicates whether a particular shaft is within specification without giving its exact dimensions—and a p -chart could be used. Measuring is more costly and time-consuming per unit than the yes-no inspection using a go, no-go gauge, but because measuring supplies more information than merely counting items as good or bad, one needs a much smaller sample size for a mean chart than a p -chart. Hence, a manager must weigh the time and cost of sampling against the information provided.

Sampling frequency can be a function of the stability of a process and the cost to sample.

Run Tests

Control charts test for points that are too extreme to be considered random (e.g., points that are outside of the control limits). However, even if all points are within the control limits, the data may still not reflect a random process. In fact, any sort of pattern in the data would suggest a nonrandom process. Figure 10.11 illustrates some patterns that might be present.

Run test A test for patterns in a sequence.

LO10.6 Perform run tests to check for nonrandomness in process output.

Analysts often supplement control charts with a **run test**, which checks for patterns in a sequence of observations. This enables an analyst to do a better job of detecting abnormalities in a process and provides insights into correcting a process that is out of control. A variety of run tests are available. This section describes two that are widely used.

When a process is stable or in statistical control, the output it generates will exhibit random variability over a period of time. The presence of patterns, such as trends, cycles, or bias in the output indicates that assignable, or nonrandom, causes of variation exist. Hence, a process that produces output with such patterns is not in a state of statistical control. This is true even though all points on a control chart may be within the control limits. For this reason, it is usually prudent to subject control chart data to run tests to determine whether patterns can be detected.

Run Sequence of observations with a certain characteristic.

A **run** is defined as a sequence of observations with a certain characteristic, followed by one or more observations with a different characteristic. The characteristic can be anything that is observable. For example, in the series A A A B, there are two runs: a run of three A's

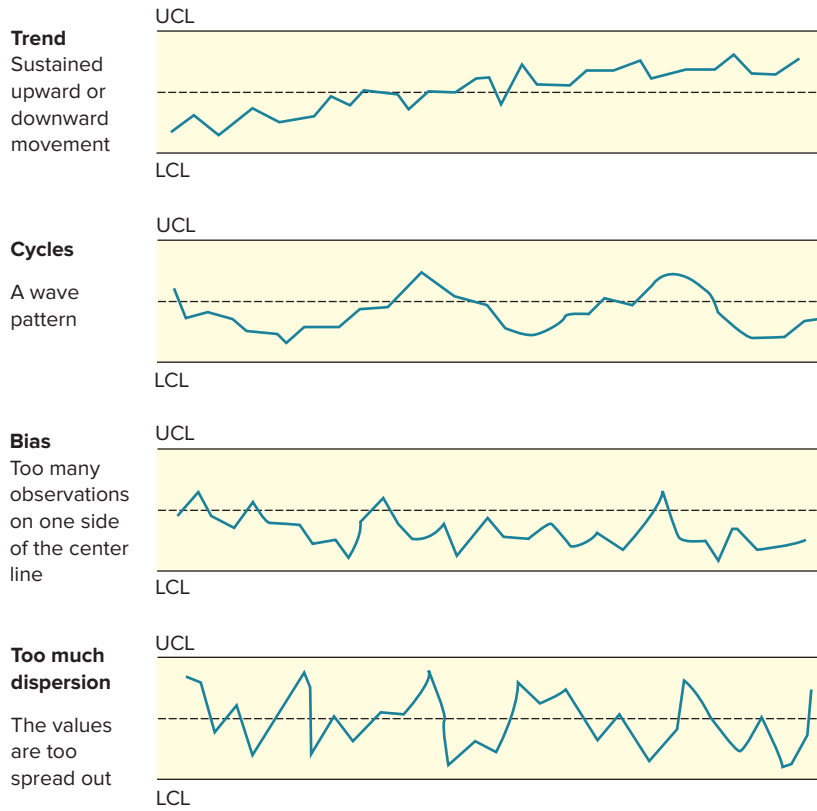

FIGURE 10.11
Some examples of nonrandom patterns in control chart plots

followed by a run of one B. Underlining each run helps in counting them. In the series AA BBB A, the underlining indicates three runs.

Two useful run tests involve examination of the number of runs *up and down* and runs above and below the *median*.² In order to count these runs, the data are transformed into a series of U's and D's (for *up* and *down*) and into a series of A's and B's (for *above* and *below* the median). Consider the following sequence, which has a median of 36.5. The first two values are below the median, the next two are above it, the next to last is below, and the last is above. Thus, there are four runs:

25	29	42	40	35	38
<u>B</u>	<u>B</u>	<u>A</u>	<u>A</u>	<u>B</u>	<u>A</u>

In terms of up and down, there are three runs in the same data. The second value is up from the first value, the third is up from the second, the fourth is down from the third, and so on:

25	29	42	40	35	38
—	<u>U</u>	<u>U</u>	<u>D</u>	<u>D</u>	<u>U</u>

(The first value does not receive either a U or a D because nothing precedes it.)

If a plot is available, the runs can be easily counted directly from the plot, as illustrated in Figures 10.12 and 10.13.

²The median and mean are approximately equal for control charts. The use of the median depends on its ease of determination; use the mean instead of the median if it is given.

FIGURE 10.12
Counting above/below median runs

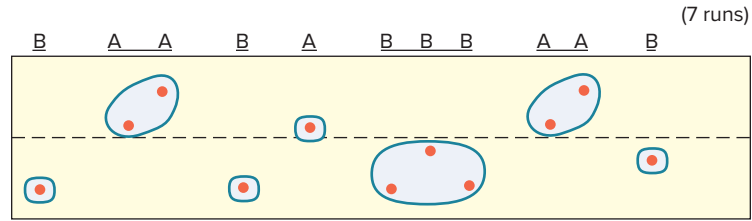
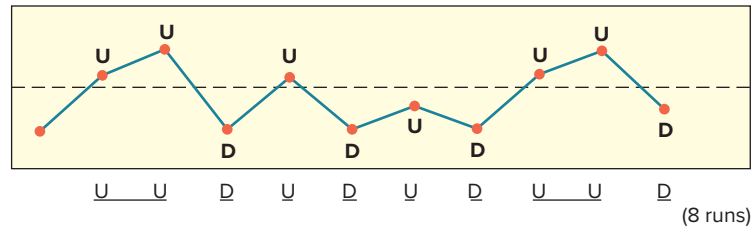

FIGURE 10.13
Counting up/down runs



To determine whether any patterns are present in control chart data, one must transform the data into both A's and B's and U's and D's, and then count the number of runs in each case. These numbers must then be compared with the number of runs that would be expected in a completely random series. For both the median and the up/down run tests, the expected number of runs is a function of the number of observations in the series. The formulas are

$$E(r)_{\text{med}} = \frac{N}{2} + 1 \tag{10-6a}$$

$$E(r)_{\text{u/d}} = \frac{2N - 1}{3} \tag{10-7a}$$

where N is the number of observations or data points, and $E(r)$ is the expected number of runs.

The actual number of runs in any given set of observations will vary from the expected number, due to chance and any patterns that might be present. Chance variability is measured by the standard deviation of runs. The formulas are

$$\sigma_{\text{med}} = \sqrt{\frac{N - 1}{4}} \tag{10-6b}$$

$$\sigma_{\text{u/d}} = \sqrt{\frac{16N - 29}{90}} \tag{10-7b}$$

Distinguishing chance variability from patterns requires use of the sampling distributions for median runs and up/down runs. Both distributions are approximately normal. Thus, for example, 95.5 percent of the time a random process will produce an observed number of runs within two standard deviations of the expected number. If the observed number of runs falls in that range, there are probably no nonrandom patterns; for observed numbers of runs beyond such limits, we begin to suspect that patterns are present. Too few or too many runs can be an indication of nonrandomness.

In practice, it is often easiest to compute the number of standard deviations, z , by which an observed number of runs differs from the expected number. This z value would then be compared to the value ± 2 (z for 95.5 percent) or some other desired value (e.g., ± 1.96 for 95 percent, ± 2.33 for 98 percent). A test z that exceeds the desired limits indicates patterns might be present. (See Figure 10.14.) The computation of z takes the form.

$$z_{\text{test}} = \frac{\text{Observed number of runs} - \text{Expected number of runs}}{\text{Standard deviation of number of runs}}$$

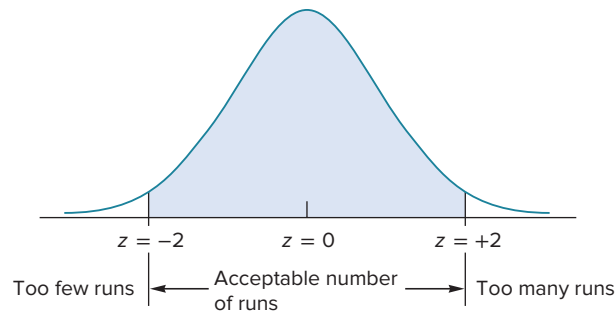
**FIGURE 10.14**

A sampling distribution for runs is used to distinguish chance variation from patterns

For the median and up/down tests, one can find z using these formulas:

$$\text{Median: } z = \frac{r - [(N/2) + 1]}{\sqrt{(N-1)/4}} \quad (10-8)$$

$$\text{Up and down: } z = \frac{r - [(2N-1)/3]}{\sqrt{(16N-29)/90}} \quad (10-9)$$

where

N = Total number of observations

r = Observed number of runs of either A's and B's or U's and D's, depending on which test is involved

It is desirable to apply both run tests to any given set of observations, because each test is different in terms of the types of patterns it can detect. Sometimes both tests will pick up a certain pattern, but sometimes only one will detect nonrandomness. If either does, the implication is that some sort of nonrandomness is present in the data.

Testing for Nonrandomness Using Run Tests

Twenty sample means have been taken from a process. The means are shown in the following table. Use median and up/down run tests with $z = 2$ to determine if assignable causes of variation are present. Assume the median is 11.0.

EXAMPLE 6

excel

mhhe.com/stevenson14e

The means are marked according to above/below the median and up/down. The solid lines represent the runs.

SOLUTION

Sample	A/B	Mean	U/D	Sample	A/B	Mean	U/D
1	B	10.0	—	11	IB	10.7	ID
2	B	10.4	IU	12	IA	11.3	IU
3	B	10.2	ID	13	IB	10.8	ID
4	IA	11.5	IU	14	A	11.8	IU
5	IB	10.8	ID	15	A	11.2	ID
6	A	11.6	IU	16	A	11.6	IU
7	A	11.1	ID	17	A	11.2	ID
8	A	11.2	IU	18	B	10.6	ID
9	B	10.6	ID	19	B	10.7	IU
10	B	10.9	IU	20	IA	11.9	IU

A/B: 10 runs

U/D: 17 runs

The expected number of runs for each test is

$$E(r)_{\text{med}} = \frac{N}{2} + 1 = \frac{20}{2} + 1 = 11$$

$$E(r)_{\text{u/d}} = \frac{2N - 1}{3} = \frac{2(20) - 1}{3} = 13$$

The standard deviations are

$$\sigma_{\text{med}} = \sqrt{\frac{N - 1}{4}} = \sqrt{\frac{20 - 1}{4}} = 2.18$$

$$\sigma_{\text{u/d}} = \sqrt{\frac{16N - 29}{90}} = \sqrt{\frac{16(20) - 29}{90}} = 1.80$$

The z_{test} values are

$$z_{\text{med}} = \frac{10 - 11}{2.18} = -.46$$

$$z_{\text{u/d}} = \frac{17 - 13}{1.80} = +2.22$$

Although the median test does not reveal any pattern, because its z_{test} value is within the range ± 2 , the up/down test does; its value exceeds $+2$. Consequently, nonrandom variations are probably present in the data and, hence, the process is not in control.

If ties occur in either test (e.g., a value equals the median or two values in a row are the same), assign A/B or U/D in such a manner that z_{test} is as large as possible. If z_{test} still does not exceed ± 2 (± 1.96 , etc.), you can be reasonably confident that a conclusion of randomness is justified.

Using Control Charts and Run Tests Together

Although for instructional purposes most of the examples, solved problems, and problems focus on either control charts or run tests, ideally both control charts and run tests should be used to analyze process output, along with a plot of the data. The procedure involves the following three steps:

1. Compute control limits for the process output.
 - a. Determine which type of control chart is appropriate (see Figure 10.18 in the chapter summary).
 - b. Compute control limits using the appropriate formulas. If no probability is given, use a value of $z = 2.00$ to compute the control limits.
 - c. If any sample statistics fall outside of the control limits, the process is not in control. If all values are within the control limits, proceed to Step 2.
2. Conduct median and up/down run tests. Use $z = \pm 2.00$ for comparing the test scores. If either or both test scores are not within $z = \pm 2.00$, the output is probably not random. If both test scores are within $z = \pm 2.00$, proceed to Step 3.
3. *Note:* If you are at this point, there is no indication so far that the process output is nonrandom. Plot the sample data and visually check for patterns (e.g., cycling). If you see a pattern, the output is probably not random. Otherwise, conclude the output is random and that the process is in control.

What Happens When a Process Exhibits Possible Nonrandom Variation?

Nonrandom variation is indicated when a point is observed that is outside the control limits, or a run test produces a large z -value (e.g., greater than ± 1.96). Managers should have response plans in place to investigate the cause. It may be a false alarm (i.e., a Type I error), or it may be a real indication of the presence of an assignable cause of variation. If it appears to be a false alarm, resume the process but monitor it for a while to confirm this. If an assignable cause can be found, it needs to be addressed. If it is a good result (e.g., an observation below the lower control limit of a p -chart, a c -chart, or a range chart would indicate unusually good quality), it may be possible to change the process to achieve similar results on an ongoing basis. The more typical case is that there is a problem that needs to be corrected. Operators can be trained to handle simple problems, while teams may be needed to handle more complex problems. Problem solving often requires the use of various tools, described in Chapter 9, to find the root cause of the problem. Once the cause has been found, changes can be made to reduce the chance of recurrence.

10.4 PROCESS CAPABILITY

Once the stability of a process has been established (i.e., no nonrandom variations are present), it is necessary to determine if the process is capable of producing output that is within an acceptable range. The variability of a process becomes the focal point of the analysis.

Three commonly used terms refer to the variability of process output. Each term relates to a slightly different aspect of that variability, so it is important to differentiate these terms.

Specifications or *tolerances* are established by engineering design or customer requirements. They indicate a range of values in which individual units of output must fall in order to be acceptable.

Control limits are statistical limits that reflect the extent to which *sample statistics* such as means and ranges can vary due to randomness alone.

Process variability reflects the natural or inherent (i.e., random) variability in a process. It is measured in terms of the process standard deviation.

Specifications A range of acceptable values established by engineering design or customer requirements.

Process variability Natural or inherent variability in a process.



Moreno Soppelsa/Shutterstock

To maximize production of a machine run in a paper mill, the machine's alignment must be correct. If not, performance and quality will be affected, which could result in machine downtime and expensive repairs. The on-board processor calculates the position of the paper in relationship to the machine datum. Two points are then measured on the roller. With the simple press of a button, the operator is provided with any deviations on a display panel.

Control limits and process variability are directly related: Control limits are based on sampling variability, and sampling variability is a function of process variability. On the other hand, there is *no* direct link between specifications and either control limits or process variability. They are specified in terms of the output of a product or service, not in terms of the *process* by which the output is generated. Hence, in a given instance, the output of a process may or may not conform to specifications, even though the process may be statistically in control. That is why it is also necessary to take into account the *capability* of a process. The term **process capability** refers to the inherent variability of process output *relative to* the variation allowed by the design specifications. The following section describes capability analysis.

Process capability The inherent variability of process output relative to the variation allowed by the design specification.

Capability Analysis

Capability analysis is performed on a process that is in control (i.e., the process exhibits only random variation) for the purpose of determining if the range of variation is within design specifications that would make the output acceptable for its intended use. If it is within the specifications, the process is said to be “capable.” If it is not, the manager must decide how to correct the situation.

Consider the three cases illustrated in Figure 10.15. In the first case, process capability and output specifications are well matched, so that nearly all of the process output can be expected to meet the specifications. In the second case, the process variability is much less than what is called for, so that virtually 100 percent of the output should be well within tolerance. In the third case, however, the specifications are tighter than what the process is capable of, so that even when the process is functioning as it should, a sizable percentage of the output will fail to meet the specifications. In other words, the process could be in control and still generate unacceptable output. Thus, we cannot automatically assume that a process that is in control will provide the desired output. Instead, we must specifically check whether a process is *capable* of meeting specifications and not simply set up a control chart to monitor it. A process should be both in control and within specifications *before* production begins—in essence, “Set the toaster correctly at the start. Don’t burn the toast and then scrape it!”

In instances such as case C in Figure 10.15, a manager might consider a range of possible solutions: (1) redesign the process so it can achieve the desired output, (2) use an alternative process that can achieve the desired output, (3) retain the current process but attempt to eliminate unacceptable output using 100 percent inspection, and (4) examine the specifications to see whether they are necessary or could be relaxed without adversely affecting customer satisfaction.

It is also worthwhile to note that different categories of customers (e.g., consumer versus industrial) might have different sets of specifications due to differing applications.

Obviously, process variability is the key factor in process capability. It is measured in terms of the process standard deviation. To determine whether the process is capable, compare ± 3 standard deviations (i.e., 6 standard deviations) of the process to the specifications for the process. For example, suppose the ideal length of time to perform a service is 10 minutes, and an acceptable range of variation around this time is ± 1 minute. If the process has a standard deviation of .5 minute, it would not be capable because ± 3 standard deviations would be ± 1.5 minutes, exceeding the specification of ± 1 minute.

FIGURE 10.15 Process capability and specifications may or may not match

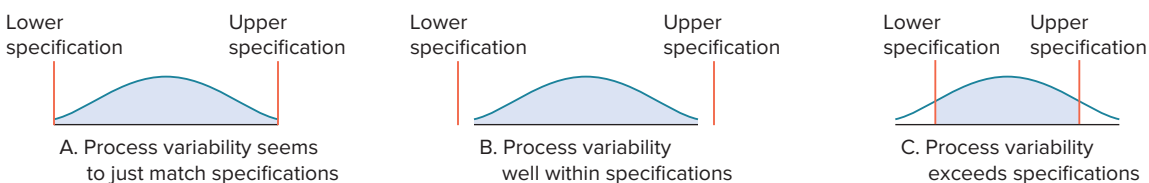

Determining If a Process Is Capable

A manager has the option of using any one of three machines for a job. The processes and their standard deviations are listed as follows. Determine which machines are capable if the specifications are 10.00 mm and 10.80 mm.

Process	Standard Deviation (mm)
A	.13
B	.08
C	.16

EXAMPLE 7

excel
mhhe.com/stevenson14e

Determine the extent of process variability (the process width) of each process (i.e., six standard deviations) and compare that value to the specification *difference* of .80 mm.

SOLUTION

Process	Standard Deviation (mm)	Process Width
A	.13	.78
B	.08	.48
C	.16	.96

C_p

To assess the capability of a machine or process, a **capability index** can be computed using the following formula:

$$\begin{aligned} \text{Process capability index, } C_p &= \frac{\text{Specification width}}{\text{Process width}} \\ &= \frac{\text{Upper specification} - \text{Lower specification}}{6\sigma \text{ of the process}} \end{aligned} \quad (10-10)$$

capability index Used to assess the ability of a process to meet specifications.

LO10.7 Assess process capability.

The widely accepted standard for a process to be deemed to be capable is to have a capability index of at least 1.33. Although an index of 1.00 might seem that the process is just capable, even a slight deviation in the process for any reason would cause the process not to be capable. Using an index of at least 1.33 allows some leeway. Because it is not unusual for some processes to “wobble” a bit from time to time, an index of 1.33 provides a cushion.

An index of 1.00 implies about 2,700 parts per million (ppm) can be expected to not be within the specifications, while an index of 1.33 implies only about 30 ppm won't be within specs. Moreover, the greater the capability index, the greater the probability that the output of a process will fall within design specifications.

Computing a Process Capability Index

EXAMPLE 8

Compute the process capability index for each process in Example 7.

The specification width in Example 7 is .80 mm. Hence, to determine the capability index for each process, divide .80 by the process width (i.e., six standard deviations) of each machine. The results are shown in the following table.

SOLUTION

Process	Standard Deviation (mm)	Process Capability	C_p
A	.13	.78	.80/.78 = 1.03
B	.08	.48	.80/.48 = 1.67
C	.16	.96	.80/.96 = 0.83

We can see that only process B is capable because its index is not less than 1.33. (See Figure 10.15 for a visual portrayal of these results.)

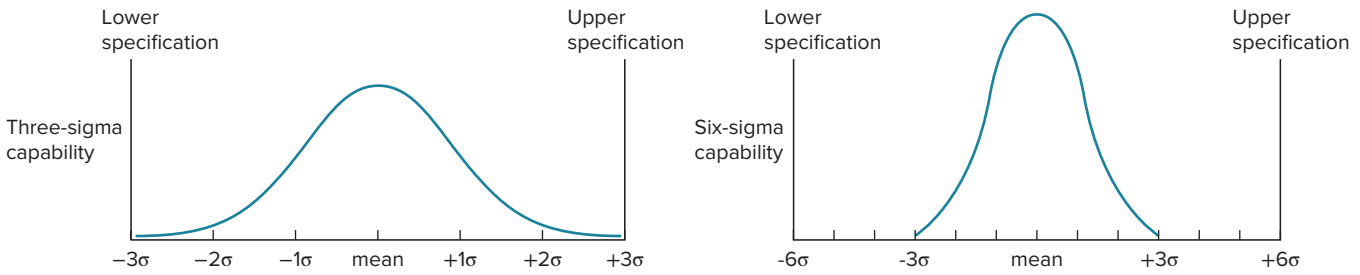
FIGURE 10.16 Three-sigma versus Six-Sigma capability

For processes that are not capable, several options might be considered, such as performing 100 percent inspection to weed out unacceptable items, improving the process to reduce variability, switching to a capable process, outsourcing, and so forth.

The Motorola Corporation is well known for its use of the term *Six Sigma*, which refers to its goal of achieving a process variability so small that the design specifications represent six standard deviations above *and* below the process mean. That means a process capability index equal to 2.00, resulting in an extremely small probability of getting any output not within the design specifications. This is illustrated in Figure 10.16.

To get an idea of how a capability index of 2.00 compares to an index of, say, 1.00, in terms of defective items, consider that if the U.S. Postal Service had a capability index of 1.00 for delivery errors of first-class mail, this would translate into about 10,000 misdelivered pieces per day; if the capability index was 2.00, that number would drop to about 1,000 pieces a day.

Care must be taken when interpreting the C_p index, because its computation does not involve the process mean. Unless the target value (i.e., process mean) is *centered* between the upper and lower specifications, the C_p index can be misleading. For example, suppose the specifications are 10 and 11, and the standard deviation of the process is equal to .10. The C_p would seem to be very favorable:

$$\frac{11 - 10}{6(.10)} = 1.67$$

However, suppose that the process mean is 12, with a standard deviation of .10; ± 3 standard deviations would be 11.70 to 12.30, so it is very unlikely that *any* of the output would be within the specifications of 10 to 11!

There are situations in which the target value is not centered between the specifications, either intentionally or unavoidably. In such instances, a more appropriate measure of process capability is the C_{pk} index, because it does take the process mean into account.

C_{pk}

If a process is not centered, a slightly different measure is used to compute its capability. This index is represented by the symbol C_{pk} . It is computed by finding the difference between each of the specification limits and the mean, identifying the smaller difference, and dividing that difference by three standard deviations of the process. Thus, C_{pk} is equal to the *smaller* of

$$\frac{\text{Upper specification} - \text{Process mean}}{3\sigma} \quad (10-11)$$

and

$$\frac{\text{Process mean} - \text{Lower specification}}{3\sigma}$$

You might be wondering why a process wouldn't be centered as a matter of course. One reason is that only a range of acceptable values, not a target value, may be specified. A more compelling reason is that the cost of nonconformance is greater for one specification limit than it is for nonconformance for the other specification limit. In that case, it would

Computing C_{pk}

A process has a mean of 9.20 grams and a standard deviation of .30 gram. The lower specification limit is 7.50 grams and the upper specification limit is 10.50 grams. Compute C_{pk} .

EXAMPLE 9

excel

mhhe.com/stevenson14e

SOLUTION

1. Compute the index for the lower specification:

$$\frac{\text{Process mean} - \text{Lower specification}}{3\sigma} = \frac{9.20 - 7.50}{3(.30)} = \frac{1.70}{.90} = 1.89$$

2. Compute the index for the upper specification:

$$\frac{\text{Upper specification} - \text{Process mean}}{3\sigma} = \frac{10.50 - 9.20}{3(.30)} = \frac{1.30}{.90} = 1.44$$

The *smaller* of the two indexes is 1.44, so this is the C_{pk} . Because the C_{pk} is more than 1.33, the process is capable.

make sense to have the target value be closer to the spec that has the lower cost of nonconformance. This would result in a noncentered process.

Improving Process Capability

Improving process capability requires reducing the process variability that is inherent in a process. This might involve simplifying, standardizing, making the process mistake-proof, upgrading equipment, or automating. See Table 10.5 for examples.

Improved process capability means less need for inspection, lower warranty costs, fewer complaints about service, and higher productivity. For process control purposes, it means narrower control limits.

Taguchi Loss Function

Genichi Taguchi, a Japanese quality expert, holds a nontraditional view of what constitutes poor quality, and hence the cost of poor quality. The traditional view is that as long as output is within specifications, there is no cost. Taguchi believes that any deviation from the target value represents poor quality, and that the farther away from the target a deviation is, the greater the cost. Figure 10.17 illustrates the two views. The implication for Taguchi is that reducing the variation inherent in a process (i.e., increasing its capability ratio) will result in lowering the cost of poor quality, and consequently, the loss to society.

Limitations of Capability Indexes

There are several risks of using a capability index:

- The process may not be stable, in which case a capability index is meaningless.
- The process output may not be normally distributed, in which case inferences about the fraction of output that isn't acceptable will be incorrect.
- The process is not centered, but the C_p index is used, giving a misleading result.

Method	Examples
Simplify	Eliminate steps, reduce the number of parts, use modular design
Standardize	Use standard parts, standard procedures
Make mistake-proof	Design parts that can only be assembled the correct way; have simple checks to verify a procedure has been performed correctly
Upgrade equipment	Replace worn-out equipment; take advantage of technological improvements
Automate	Substitute automated processing for manual processing

TABLE 10.5

Process capability improvement



RFID CHIPS MIGHT CUT DRUG ERRORS IN HOSPITALS



Fuse/Getty Images

It's estimated that more than 250,000 people in the United States die each year because of drug errors, and many others suffer ill effects from being given the wrong drug or the wrong dosage. Some hospitals are using RFID chips attached to patients' wristbands that allow hospital personnel who administer drugs to patients to electronically check to make sure the drug and dosage are appropriate. Before administering a drug, the doctor or nurse scans the medication to see if it matches the patient's RFID tag to verify that the medication and time are correct.

Questions

1. Why are RFID chips being used in hospitals?
2. Where else in a hospital would these patient RFID tags be useful?

Sources: https://www.hopkinsmedicine.org/news/media/releases/study_suggests_medical_errors_now_third_leading_cause_of_death_in_the_us and <https://hbr.org/2015/12/how-rfid-technology-improves-hospital-care>

FIGURE 10.17
Taguchi and traditional views of the cost of poor quality

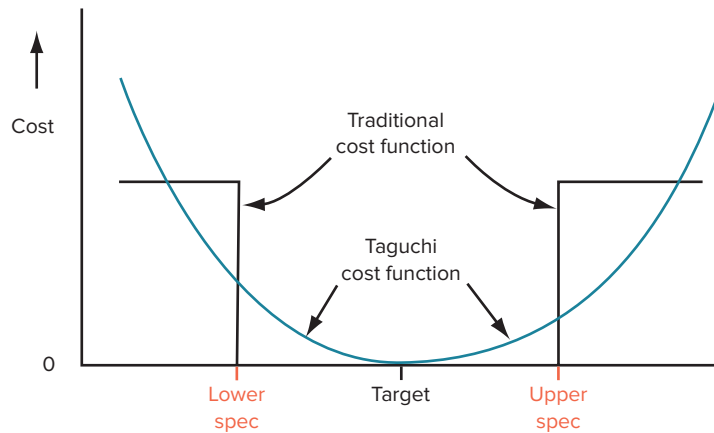

10.5 OPERATIONS STRATEGY

Quality is a major consideration for virtually all customers, so achieving and maintaining quality standards is of strategic importance to all business organizations. Quality assurance and product and service design are two vital links in the process. Organizations should continually seek to increase the capability of the processes they use, so they can move from a position of using inspection or extensive use of control charts to achieve desired levels of quality to one where quality is built into products and processes, so that little or no effort is needed to assure quality. Processes that exhibit evidence of nonrandomness, or processes that are deemed to not be capable, should be viewed as opportunities for continuous process improvement.

This chapter describes inspection and statistical process control. Inspection means examining the output of a process to determine whether it is acceptable. Key issues in inspection include where to inspect in the process, how often to inspect, and whether to inspect on-site or in a laboratory.

Statistical process control focuses on detecting departures from randomness in a process. Two basic tools of process control are control charts and run tests. Figure 10.18 gives an overview of quality control. The general theory of control charts is discussed, and four types of control charts—two for variables and two for attributes—and two types of run tests are described in the chapter. The chapter ends with a discussion of process capability. Process capability studies are used to determine if the output of a process will satisfy specifications. They can provide valuable information for managers in terms of reducing costs and avoiding problems created by generating output that is not within specifications. Table 10.6 provides a summary of formulas.

SUMMARY

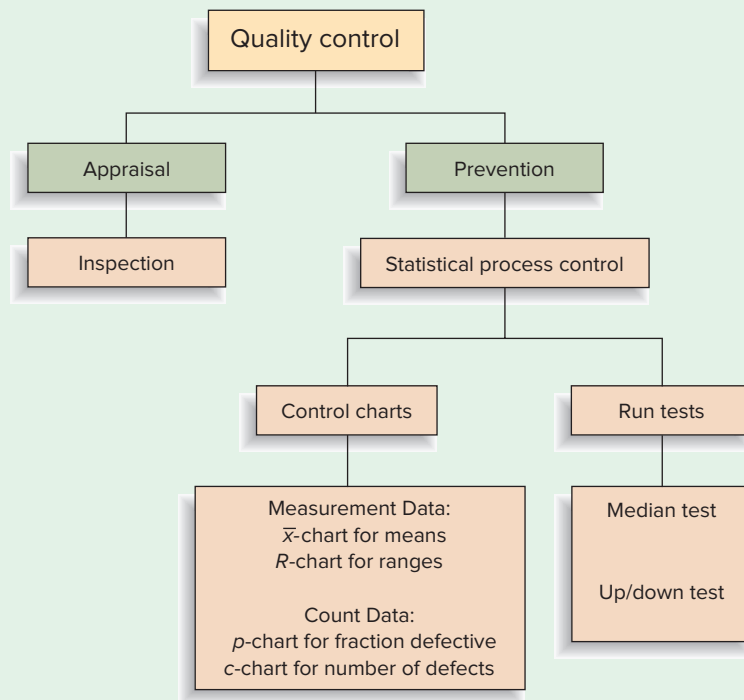

FIGURE 10.18
Overview of quality control

CONTROL CHARTS		
Name	Usage	Control Limits
Mean, \bar{x} -bar chart	Measurement data. Use for average.	$\bar{\bar{x}} \pm z \frac{\sigma}{\sqrt{n}}$ or $\bar{\bar{x}} \pm A_2 \bar{R}$ $n = \text{sample size}$
Range, R chart	Measurement data. Use for range or dispersion.	$UCL = D_4 \bar{R}, LCL = D_3 \bar{R}$
Fraction defective, p -chart	Count data. Use when both the “good” and “bad” can be counted.	$\bar{p} \pm z \sqrt{\frac{\bar{p}(1 - \bar{p})}{n}}$ $n = \text{sample size}$
Number of defects, c -chart	Count data. Use when only the “occurrences” can be counted.	$\bar{c} \pm z \sqrt{\bar{c}}$

(continued)

TABLE 10.6
Summary of formulas

TABLE 10.6
(concluded)

RUN TESTS				
Name	NUMBER OF RUNS		Standard Deviation	Z
	Observed	Expected		
Median	r	$\frac{N}{2} + 1$	$\sqrt{\frac{N-1}{4}}$	$\frac{r - [(N/2) + 1]}{\sqrt{(N-1)/4}}$
Up/down	r	$\frac{2N-1}{3}$	$\sqrt{\frac{16N-29}{90}}$	$\frac{r - [(2N-1)/3]}{\sqrt{(16N-29)/90}}$

N = number of observations

PROCESS CAPABILITY		
Name	Symbol	Formula
Capability index for a centered process	C_p	$\frac{\text{Specification width}}{6\sigma \text{ of process}}$
Capability index for a noncentered process	C_{pk}	Smaller of $\left\{ \begin{array}{l} \frac{\text{Mean} - \text{Lower specification}}{3\sigma} \\ \frac{\text{Upper specification} - \text{Mean}}{3\sigma} \end{array} \right.$

KEY POINTS

1. All processes exhibit random variation. Quality control’s purpose is to identify a process that also exhibits nonrandom (correctable) variation on the basis of sample statistics (e.g., sample means) obtained from the process.
2. Control charts and run tests can be used to detect nonrandom variation in sample statistics. It is also advisable to plot the data to visually check for patterns.
3. If a process does not exhibit nonrandom variation, its capability to produce output that meets specifications can be assessed.

KEY TERMS

- | | | |
|----------------------------|-----------------------------|--|
| assignable variation, 425 | p -chart, 434 | sampling distribution, 425 |
| attributes, 430 | process capability, 444 | specifications, 443 |
| capability index, 445 | process variability, 443 | statistical process control (SPC), 425 |
| c -chart, 436 | quality control, 419 | Type I error, 429 |
| central limit theorem, 426 | quality of conformance, 425 | Type II error, 429 |
| control chart, 428 | random variation, 425 | variables, 430 |
| control limits, 428 | range control chart, 432 | |
| inspection, 420 | run, 438 | |
| mean control chart, 430 | run test, 438 | |

SOLVED PROBLEMS

Problem 1 *Process distribution and sampling distribution.* An industrial process that makes 3-foot sections of plastic pipe produces pipe with an average inside diameter of 1 inch and a standard deviation of .05 inch.

- a. If you randomly select one piece of pipe, what is the probability that its inside diameter will exceed 1.02 inches, assuming the population is normal?
- b. If you select a random sample of 25 pieces of pipe, what is the probability that the sample mean will exceed 1.02 inches?

$\mu = 1.00, \sigma = .05$

a. $z = \frac{x - \mu}{\sigma} = \frac{1.02 - 1.00}{.05} = .40$

Using Appendix B, Table A, $P(z > .4) = .5000 - .1554 = .3446$

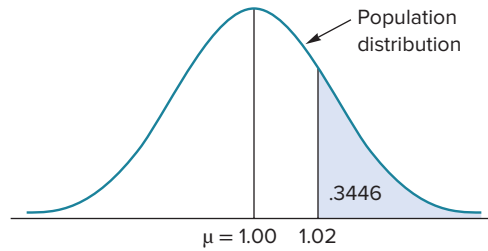

b. $z = \frac{\bar{x} - \mu}{\sigma/\sqrt{n}} = \frac{1.02 - 1.00}{.05/\sqrt{25}} = 2.00$

Using Appendix B, Table A, $P(z > 2.00) = .5000 - .4772 = .0228$

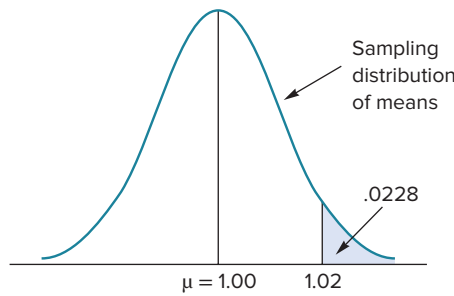

Solution

Control charts for means and ranges. Processing times for new accounts at a bank are shown in the following table. Five samples of four observations each have been taken. Use the sample data in conjunction with Table 10.3 to construct upper and lower control limits for both a mean chart and a range chart. Do the results suggest that the process is in control?

Problem 2

	Sample 1	Sample 2	Sample 3	Sample 4	Sample 5
	10.2	10.3	9.7	9.9	9.8
	9.9	9.8	9.9	10.3	10.2
	9.8	9.9	9.9	10.1	10.3
	<u>10.1</u>	<u>10.4</u>	<u>10.1</u>	<u>10.5</u>	<u>9.7</u>
Totals	40.0	40.4	39.6	40.8	40.0

a. Determine the mean and range of each sample.

Solution

$\bar{x} = \frac{\sum x}{n}$, Range = Largest - Smallest

Sample	Mean	Range
1	$40.0/4 = 10.0$	$10.2 - 9.8 = .4$
2	$40.4/4 = 10.1$	$10.4 - 9.8 = .6$
3	$39.6/4 = 9.9$	$10.1 - 9.7 = .4$
4	$40.8/4 = 10.2$	$10.5 - 9.9 = .6$
5	$40.0/4 = 10.0$	$10.3 - 9.7 = .6$

- b. Compute the average mean and average range:

$$\bar{\bar{x}} = \frac{10.0 + 10.1 + 9.9 + 10.2 + 10.0}{5} = \frac{50.2}{5} = 10.04$$

$$\bar{R} = \frac{.4 + .6 + .4 + .6 + .6}{5} = \frac{2.6}{5} = .52$$

- c. Obtain factors A_2 , D_4 , and D_3 from Table 10.3 for $n = 4$: $A_2 = .73$, $D_4 = 2.28$, $D_3 = 0$.

- d. Compute upper and lower limits:

$$UCL_{\bar{x}} = \bar{\bar{x}} + A_2 \bar{R} = 10.04 + .73(.52) = 10.42$$

$$LCL_{\bar{x}} = \bar{\bar{x}} - A_2 \bar{R} = 10.04 - .73(.52) = 9.66$$

$$UCL_R = D_4 \bar{R} = 2.28(.52) = 1.19$$

$$LCL_R = D_3 \bar{R} = 0(.52) = 0$$

- e. Verify that points are within limits. (If they were not, the process would be investigated to correct assignable causes of variation.)

The smallest sample mean is 9.9, and the largest is 10.2. Both are well within the control limits. Similarly, the largest sample range is .6, which is also within the control limits. Hence, the results suggest that the process is in control. Note, however, that for illustrative purposes, the number of samples is deliberately small; 20 or more samples would give a clearer indication of control limits and whether the process is in control.

Problem 3 *Type I error (alpha risk).* After several investigations of points outside control limits revealed nothing, a manager began to wonder about the probability of a Type I error for the control limits used ($z = 1.90$).

- a. Determine the alpha risk (i.e., P [Type I error]) for this value of z .
 b. What z would provide an alpha risk of about 2 percent?

Solution

- a. Using Appendix B, Table A, find that the area under the curve between $z = 0$ and $z = +1.90$ is .4713. Therefore, the area (probability) of values *within* -1.90 to $+1.90$ is $2(.4713) = .9426$, and the area *beyond* these values is $1 - .9426 = .0574$. Hence, the alpha risk is 5.74 percent.
 b. The alpha risk (Type I error probability) is always specified as an *area* in the tail(s) of a distribution. With control charts, you use two-sided control limits. Consequently, half of the risk lies in each tail. Hence, the area in the right tail is 1 percent, or .0100. This means that .4900 should be the area under the curve between $z = 0$ and the value of z you are looking for. The closest value is .4901 for $z = 2.33$. Thus, control limits based on $z = \pm 2.33$ provide an alpha risk of about 2 percent.

Problem 4 *p-chart and c-chart.* Using the appropriate control chart, determine two-sigma control limits for each case:

- a. An inspector found an average of 3.9 scratches in the exterior paint of each of the automobiles being prepared for shipment to dealers.
 b. Before shipping lawn mowers to dealers, an inspector attempts to start each mower and notes any that do not start on the first try. The lot size is 100 mowers, and an average of 4 did not start (4 percent).

Solution

The choice between these two types of control charts relates to whether *two* types of results can be counted (*p-chart*) or whether *only occurrences* can be counted (*c-chart*).

- a. The inspector can only count the scratches that occurred, not the ones that did not occur. Consequently, a *c-chart* is appropriate. The sample average is 3.9 scratches per car. Two-sigma control limits are found using the following formulas:

$$UCL = \bar{c} + z \sqrt{\bar{c}}$$

$$LCL = \bar{c} - z \sqrt{\bar{c}}$$

where $\bar{c} = 3.9$ and $z = 2$. Thus,

$$UCL = 3.9 + 2 \sqrt{3.9} = 7.85 \text{ scratches}$$

$$LCL = 3.9 - 2 \sqrt{3.9} = -.05, \text{ so the lower limit is 0 scratches}$$

(Note: Round to zero only if the computed lower limit is negative.)

b. The inspector can count both the lawn mowers that started and those that did not start. Consequently, a p -chart is appropriate. Two-sigma control limits can be computed using the following:

$$UCL = \bar{p} + z \sqrt{\frac{\bar{p}(1 - \bar{p})}{n}}$$

$$LCL = \bar{p} - z \sqrt{\frac{\bar{p}(1 - \bar{p})}{n}}$$

where

$$\bar{p} = .04$$

$$n = 100$$

$$z = 2$$

Thus,

$$UCL = .04 + 2 \sqrt{\frac{.04(.96)}{100}} = .079$$

$$LCL = .04 - 2 \sqrt{\frac{.04(.96)}{100}} = .001$$

Run tests. The number of defective items per sample for 11 samples is shown below. Determine if nonrandom patterns are present in the sequence.

Problem 5

	SAMPLE										
	1	2	3	4	5	6	7	8	9	10	11
Number of defectives	22	17	19	25	18	20	21	17	23	23	24

Because the median isn't given, it must be estimated from the sample data. To do this, array the data from low to high; the median is the middle value. (In this case, there is an odd number of values. For an even number of values, average the middle two to obtain the median.) Thus,

Solution

17	17	18	19	20	21	22	23	23	24	25
		(5 below)			↑				(5 above)	
					median					

The median is 21.

Next, code the observations using A/B and U/D:

Sample	A/B	Number of Defectives	U/D
1	A	22	—
2	B	17	D
3	B	19	U
4	A	25	U
5	B	18	D
6	B	20	U
7	tie	21	U
8	B	17	D
9	A	23	U
10	A	23	tie
11	A	24	U

Note that each test has tied values. How these are resolved can affect the number of observed runs. Suppose you adhere to this rule: Assign letter (A or B, U or D) so that the resulting difference between the observed and expected number of runs is as large as possible. To accomplish this, it is necessary to initially ignore ties and count the runs to see whether there are too many or too few.

Then, return to the ties and make the assignments. The rationale for this rule is that it is a conservative method for retaining data. If you conclude that the data are random using this approach, you can be reasonably confident that the method has not “created” randomness. With this in mind, assign a B to sample 7 because the expected number of runs is

$$E(r)_{\text{med}} = N/2 + 1 = 11/2 + 1 = 6.5$$

and the difference between the resulting number of runs, 5, and 6.5 is greater than between 6.5 and 7 (which occurs if A is used instead of B). Similarly, in the up/down test, a U for sample 10 produces six runs, whereas a D produces eight runs. Because the expected number of runs is

$$E(r)_{\text{wd}} = (2N - 1) \div 3 = (22 - 1) \div 3 = 7$$

it makes no difference which one is used: Both yield a difference of 1. For the sake of illustration, a D is assigned.

The computations for the two tests are summarized as follows. Each test has a z -value that is within the range of ± 2.00 . Because neither test reveals nonrandomness, you may conclude that the data are random.

	Runs Observed	Expected	σ_r	z	Conclude
Median	5	6.5	1.58	-.95	Random
Up/down	8	7.0	1.28	.78	Random

Problem 6 Process capability. Determine which of these three processes are capable:

Process	Mean	Standard Deviation	Lower Spec	Upper Spec
1	7.5	.10	7.0	8.0
2	4.6	.12	4.3	4.9
3	6.0	.14	5.5	6.7

Solution Notice that the means of the first two processes are exactly in the center of their upper and lower specs. Hence, the C_p index (Formula 10–10) is appropriate. However, the third process is not centered, so C_{pk} (Formula 10–11) is appropriate.

$$\text{For Processes 1 and 2: } C_p = \frac{\text{Upper spec} - \text{Lower spec}}{6\sigma}$$

In order to be capable, C_p must be at least 1.33.

$$\text{Process 1: } C_p = \frac{8.0 - 7.0}{6(.10)} = 1.67 \text{ (capable)}$$

$$\text{Process 2: } C_p = \frac{4.9 - 4.3}{6(.12)} = .83 \text{ (not capable)}$$

For Process 3, C_{pk} must be at least 1.33. It is the lesser of these two:

$$\frac{\text{Upper spec} - \text{Mean}}{3\sigma} = \frac{6.7 - 6.0}{3(.14)} = 1.67$$

$$\frac{\text{Mean} - \text{Lower spec}}{3\sigma} = \frac{6.0 - 5.5}{3(.14)} = 1.19 \text{ (not capable)}$$

DISCUSSION AND REVIEW QUESTIONS

1. List the steps in the control process.
2. What are the key concepts that underlie the construction and interpretation of control charts?
3. What is the purpose of a control chart?
4. Why is order of observation important in process control?

5. Briefly explain the purpose of each of the following control charts.
 - a. \bar{x} -bar
 - b. Range
 - c. p -chart
 - d. c -chart
 6. What is a run? How are run charts useful in process control?
 7. If all observations are within control limits, does that guarantee that the process is random? Explain.
 8. Why is it usually desirable to use both a median run test and an up/down run test on the same data?
 9. If both run tests are used, and neither reveals nonrandomness, does that prove that the process is random? Explain.
 10. Define and contrast control limits, specifications, and process variability.
 11. A customer has recently tightened the specs for a part your company supplies. The specs are now much tighter than the machine being used for the job is capable of. Briefly identify alternatives you might consider to resolve this problem. (See Figure 10.15C.)
 12. A new order has come into your department. The capability of the process used for this type of work will enable virtually all of the output to be well within the specs. (See Figure 10.15B.)
 - a. What benefits might be derived from this situation?
 - b. What alternatives might be considered by the manager?
 13. Answer these questions about inspection:
 - a. What level of inspection is optimal?
 - b. What factors guide the decision of how much to inspect?
 - c. What are the main considerations in choosing between centralized inspection and on-site inspection?
 - d. What points are potential candidates for inspection?
 14. What two basic assumptions must be satisfied in order to use a process capability index?
 15. How important is it for managers to maintain and promote ethical behavior in dealing with quality issues? Does your answer depend on the product or service involved?
 16. Classify each of the following as either a Type I error or a Type II error.
 - a. Putting an innocent person in jail
 - b. Releasing a guilty person from jail
 - c. Eating (or not eating) a cookie that fell on the floor
 - d. Not seeing a doctor as soon as possible after ingesting poison
-
1. What trade-offs are involved in each of these decisions?
 - a. Deciding whether to use two-sigma or three-sigma control limits.
 - b. Choosing between a large sample size and a smaller sample size.
 - c. Trying to increase the capability of a process that is barely capable.
 2. Who needs to be involved in setting quality standards?
 3. Name several ways that technology has had an impact on quality control.
-
1. Analysis of the output of a process has suggested that the variability is nonrandom on several occasions recently. However, each time an investigation has not revealed any assignable causes. What are some of the possible explanations for not finding any causes? What should the manager do?
 2. Many organizations use the same process capability standard for all their products or services (e.g., 1.33), but some companies use multiple standards: different standards for different products or services (e.g., 1.00, 1.20, 1.33, and 1.40). What reasons might there be for using a single measure, and what reasons might there be for using multiple standards?
 3. Give two examples of unethical behavior for each of these areas: inspection, process control, process capability. For each, name the relevant ethical principle (see Chapter 1).
 4. In repetitive operations, it is often possible to automatically check for quality and then reject parts that are unacceptable. In these situations, does that mean control charts aren't needed? Explain.

TAKING STOCK
CRITICAL THINKING EXERCISES

PROBLEMS

1. Specifications for a part for a 3-D printer state that the part should weigh between 24 and 25 ounces. The process that produces the parts has a mean of 24.5 ounces and a standard deviation of .2 ounce. The distribution of output is normal.
 - a. What percentage of parts will not meet the weight specs?
 - b. Within what values will 95.44 percent of the sample means of this process fall if samples of $n = 16$ are taken and the process is in control (random)?
 - c. Using the control limits from part b, would the following sample means be in control? 24.52, 24.53, 24.44, 24.51, 24.41, 24.39
2. An automatic filling machine is used to fill 1-liter bottles of cola. The machine's output is approximately normal with a mean of 1.0 liter and a standard deviation of .01 liter. Output is monitored using means of samples of 25 observations.
 - a. Determine upper and lower control limits that will include roughly 97 percent of the sample means when the process is in control.
 - b. Given the following sample means—1.005, 1.001, .998, 1.002, .995, and .999—is the process in control?
 - c. Is the process in control given the following sample means—1.003, .999, .997, 1.001, 1.002, .998, and 1.004?
3. The time in minutes to replace vehicle wiper blades at a service center was monitored using a mean and a range chart. Six samples of $n = 20$ observations were obtained and the sample means and ranges were computed:

Sample	Mean	Range	Sample	Mean	Range
1	3.06	.42	4	3.13	.46
2	3.15	.50	5	3.06	.46
3	3.11	.41	6	3.09	.45

- a. Using the factors in Table 10.3, determine upper and lower limits for mean and range charts. Is the process within the control limits?
- b. The time in minutes needed to assemble security cameras at a production facility was recorded for eight samples of 15 observations each, and means and ranges were computed. Using factors from Table 10.3, compute control limits for the means and ranges to determine if the process is in control.

Sample	Mean	Range	Sample	Mean	Range
1	7.10	.52	5	7.21	.46
2	6.92	.48	6	8.01	.55
3	7.25	.50	7	7.80	.53
4	7.54	.51	8	7.63	.49

4. Software upgrade times (in minutes) are being evaluated. Samples of five observations each have been taken, and the results are as listed. Using factors from Table 10.3, determine upper and lower control limits for mean and range charts, and decide if the process is in control.

SAMPLE					
1	2	3	4	5	6
79.2	80.5	79.6	78.9	80.5	79.7
78.8	78.7	79.6	79.4	79.6	80.6
80.0	81.0	80.4	79.7	80.4	80.5
78.4	80.4	80.3	79.4	80.8	80.0
81.0	80.1	80.8	80.6	78.8	81.1

5. Using samples of 200 credit card statements, an auditor found the following:

Sample	1	2	3	4
Number with errors	4	2	5	9

- a. Determine the fraction defective in each sample.
- b. If the true fraction defective for this process is unknown, what is your estimate of it?
- c. What is your estimate of the mean and standard deviation of the sampling distribution of fractions defective for samples of this size?

- d. What control limits would give an alpha risk of .03 for this process?
 - e. What alpha risk would control limits of .047 and .003 provide?
 - f. Using control limits of .047 and .003, is the process in control?
 - g. Suppose that the long-term fraction defective of the process is known to be 2 percent. What are the values of the mean and standard deviation of the sampling distribution?
 - h. Construct a control chart for the process, assuming a fraction defective of 2 percent, using two-sigma control limits. Is the process in control?
6. A medical facility does MRIs for sports injuries. Occasionally, a test yields inconclusive results and must be repeated. Using the following sample data and $n = 200$, determine the upper and lower control limits for the fraction of retests using two-sigma limits. Is the process in control?

SAMPLE													
	1	2	3	4	5	6	7	8	9	10	11	12	13
Number of retests	1	2	2	0	2	1	2	0	2	7	3	2	1

7. The postmaster of a small western town receives a certain number of complaints each day about mail delivery. Determine three-sigma control limits using the following data. Is the process in control?

DAY														
	1	2	3	4	5	6	7	8	9	10	11	12	13	14
Number of complaints	4	10	14	8	9	6	5	12	13	7	6	4	2	10

8. Given the following data for the number of defects per spool of cable, using three-sigma limits, is the process in control?

OBSERVATION														
	1	2	3	4	5	6	7	8	9	10	11	12	13	14
Number of defects	2	3	1	0	1	3	2	0	2	1	3	1	2	0

9. After a number of complaints about its tech assistance, a computer manufacturer examined samples of calls to determine the frequency of wrong advice given to callers. Each sample consisted of 100 calls. Determine 95 percent limits. Is the tech assistance process stable (i.e., in control)? Explain.

SAMPLE																
	1	2	3	4	5	6	7	8	9	10	11	12	13	14	15	16
Number of errors	5	3	5	7	4	6	8	4	5	9	3	4	5	6	6	7

10. Specifications for a metal shaft are much wider than the machine used to make shafts is capable of. Consequently, the decision has been made to allow the cutting tool to wear a certain amount before replacement. The tool wears at the rate of .004 centimeter per piece. The process has a natural variation, σ , of .02 centimeter and is normally distributed. Specifications are 15.0 to 15.2 centimeters. A three-sigma cushion is set at each end to minimize the risk of output outside of the specifications. How many shafts can the process turn out before tool replacement becomes necessary? (See diagram.)

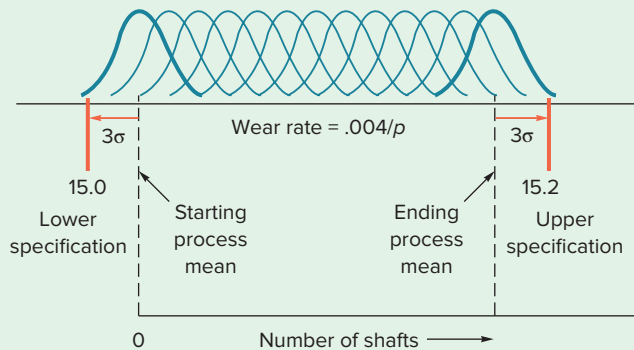

11. The lower and upper specifications for the software upgrades in Problem 4 are 78 minutes and 81 minutes. Estimate the percentage of process output that can be expected to fall within the specifications. As a manager, would you feel that the specifications are being met?
12. The time needed for checking in at a motel is to be investigated. Historically, the process has had a standard deviation equal to .146. The means of 39 samples of $n = 14$ are shown in the following table.

Sample	Mean	Sample	Mean	Sample	Mean	Sample	Mean
1	3.86	11	3.88	21	3.84	31	3.88
2	3.90	12	3.86	22	3.82	32	3.76
3	3.83	13	3.88	23	3.89	33	3.83
4	3.81	14	3.81	24	3.86	34	3.77
5	3.84	15	3.83	25	3.88	35	3.86
6	3.83	16	3.86	26	3.90	36	3.80
7	3.87	17	3.82	27	3.81	37	3.84
8	3.88	18	3.86	28	3.86	38	3.79
9	3.84	19	3.84	29	3.98	39	3.85
10	3.80	20	3.87	30	3.96		

- a. Construct an \bar{x} -chart for this process with three-sigma limits. Is the process in control?
 - b. Analyze the data using a median run test and an up/down run test. What can you conclude?
13. For each of the accompanying control charts, analyze the data using both median and up/down run tests with $z = \pm 1.96$ limits. Are nonrandom variations present? Assume the center line is the long-term median.

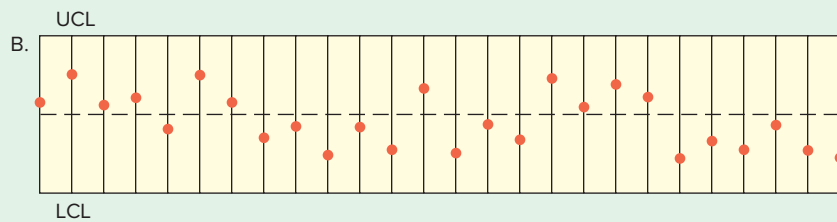
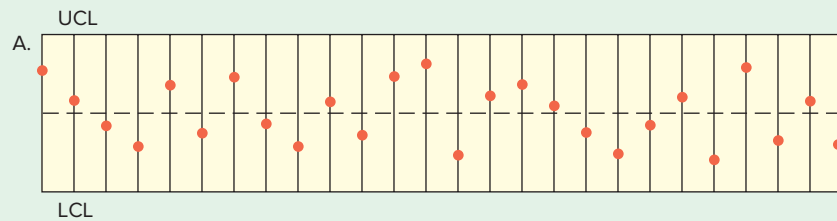

14. Analyze the data in the following problems using median and up/down run tests with $z = \pm 2$.
 - a. Given the following run test results of process output, what do the results of the run tests suggest about the process?

Test	z-score
Median	+1.37
Up/Down	+1.05

- b. Twenty means were plotted on a control chart. An analyst counted 14 runs above/below the median, and 8 up/down runs. What do the results suggest about the process?
- c. Problem 8
- d. Problem 7

15. Use both types of run tests to analyze the daily expense voucher listed. Assume a median of \$31.

Day	Amount	Day	Amount	Day	Amount	Day	Amount
1	\$27.69	16	\$29.65	31	\$40.54	46	\$25.16
2	28.13	17	31.08	32	36.31	47	26.11
3	33.02	18	33.03	33	27.14	48	29.84
4	30.31	19	29.10	34	30.38	49	31.75
5	31.59	20	25.19	35	31.96	50	29.14
6	33.64	21	28.60	36	32.03	51	37.78
7	34.73	22	20.02	37	34.40	52	34.16
8	35.09	23	26.67	38	25.67	53	38.28
9	33.39	24	36.40	39	35.80	54	29.49
10	32.51	25	32.07	40	32.23	55	30.81
11	27.98	26	44.10	41	26.76	56	30.60
12	31.25	27	41.44	42	30.51	57	34.46
13	33.98	28	29.62	43	29.35	58	35.10
14	25.56	29	30.12	44	24.09	59	31.76
15	24.46	30	26.39	45	22.45	60	34.90

16. A company has just negotiated a contract to produce a part for another firm. In the process of manufacturing the part, the inside diameter of successive parts becomes smaller and smaller as the cutting tool wears. However, the specs are so wide relative to machine capabilities that it is possible to set the diameter initially at a large value and let the process run for a while before replacing the cutting tool.

The inside diameter decreases at an average rate of .001 cm per part, and the process has a standard deviation of .05 cm. The variability is approximately normal. Assuming a three-sigma buffer at each end, how frequently must the tool be replaced if the process specifications are 3 cm and 3.5 cm?

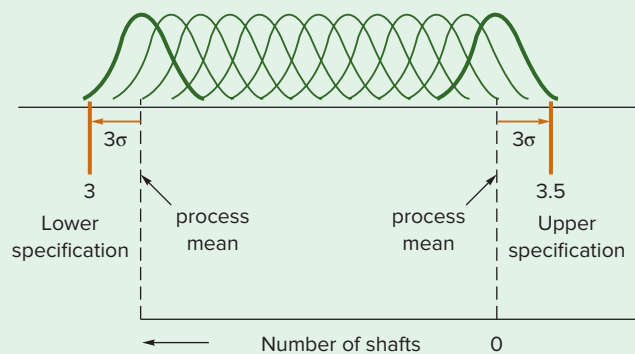

17. (Refer to Solved Problem 2.) Suppose the process specifications are 9.65 and 10.35 minutes. Based on the data given, does it appear that the specifications are being met? If not, what should one look for?
18. A production process consists of a three-step operation. The scrap rate is 10 percent for the first step and 6 percent for the other two steps.
- If the desired daily output is 450 units, how many units must be started to allow for loss due to scrap?
 - If the scrap rate for each step could be cut in half, how many units would this save in terms of the scrap allowance?
 - If the scrap represents a cost of \$10 per unit, how much is it costing the company per day for the original scrap rate?
19. (Refer to the data in Example 5.) Two additional observations have been taken. The first resulted in three defects, and the second had four defects. Using the set of 20 observations, perform run tests on the data. What can you conclude about the data?

20. A teller at a drive-up window at a bank had the following service times (in minutes) for 20 randomly selected customers.

SAMPLE			
1	2	3	4
4.5	4.6	4.5	4.7
4.2	4.5	4.6	4.6
4.2	4.4	4.4	4.8
4.3	4.7	4.4	4.5
4.3	4.3	4.6	4.9

- Determine the mean of each sample.
 - If the process parameters are unknown, estimate its mean and standard deviation.
 - Estimate the mean and standard deviation of the sampling distribution.
 - What would three-sigma control limits for the process be? What alpha risk would they provide?
 - What alpha risk would control limits of 4.14 and 4.86 provide?
 - Using limits of 4.14 and 4.86, are any sample means beyond the control limits? If so, which one(s)?
 - Construct control charts for means and ranges using Table 10.3. Are any samples beyond the control limits? If so, which one(s)?
 - Explain why the control limits are different for means in parts *d* and *g*.
 - If the process has a known mean of 4.4 and a known standard deviation of .18, what would three-sigma control limits be for a mean chart? Are any sample means beyond the control limits? If so, which one(s)?
21. A process that produces computer chips has a mean of .04 defective chip and a standard deviation of .003 chip. The allowable variation is from .03 to .05 defective.
- Compute the capability index for the process.
 - Is the process capable?
22. Given the following list of processes, the standard deviation and job specification for a set of jobs, determine which processes are capable of performing the given jobs.

Process	Standard Deviation (in.)	Job Specification (\pm in.)
001	.02	.05
002	.04	.07
003	.10	.18
004	.05	.15
005	.01	.04

23. Suppose your manager presents you with the following information about machines that could be used for a job, and wants your recommendation on which one to choose. The specification width is .48 mm. In this instance, you can narrow the set of choices, but you probably wouldn't make a recommendation without an additional piece of information. Explain why, and what additional information you would want.

Machine	Cost per Unit (\$)	Standard Deviation (mm)
A	20	.059
B	12	.060
C	11	.063
D	10	.061

24. Each of the processes listed is non-centered with respect to the specifications for that process. Compute the appropriate capability index for each, and decide if the process is capable.

Process	Mean	Standard Deviation	Lower Spec	Upper Spec
H	15.0	0.32	14.1	16.0
K	33.0	1.00	30.0	36.5
T	18.5	0.40	16.5	20.1

25. An appliance manufacturer wants to contract with a repair shop to handle authorized repairs in Indianapolis. The company has set an acceptable range of repair time of 50 minutes to 90 minutes. Two firms have submitted bids for the work. In test trials, one firm had a mean repair time of 74 minutes with a standard deviation of 4.0 minutes and the other firm had a mean repair time of 72 minutes with a standard deviation of 5.1 minutes. Which firm would you choose? Why?
26. As part of an insurance company's training program, participants learn how to conduct an analysis of clients' insurability. The goal is to have participants achieve a time in the range of 30 to 45 minutes. Test results for three participants were the following: Armand, a mean of 38 minutes and a standard deviation of 3 minutes; Jerry, a mean of 37 minutes and a standard deviation of 2.5 minutes; and Melissa, a mean of 37.5 minutes and a standard deviation of 1.8 minutes.
- Which of the participants would you judge to be capable? Explain.
 - Can the value of the C_{pk} exceed the value of C_p for a given participant? Explain.
27. The Healthy Chocolate Company makes a variety of chocolate candies, including a 12-ounce chocolate bar (340 grams) and a box of six 1-ounce chocolate bars (170 grams).
- Specifications for the 12-ounce bar are 330 grams to 350 grams. What is the largest standard deviation (in grams) that the machine that fills the bar molds can have and still be considered capable if the average fill is 340 grams?
 - The machine that fills the bar molds for the 6-ounce bars has a standard deviation of .80 gram. The filling machine is set to deliver an average of 1.01 ounces per bar. Specifications for the six-bar box are 160 to 180 grams. Is the process capable? *Hint:* The *variance* for the box is equal to six times the bar *variance*.
 - What is the *lowest* setting in ounces for the filling machine that will provide capability in terms of the six-bar box?
28. The following is a control chart for the average number of minor errors in 22 service reports. What can you conclude from these data? Explain how you reached your conclusion.

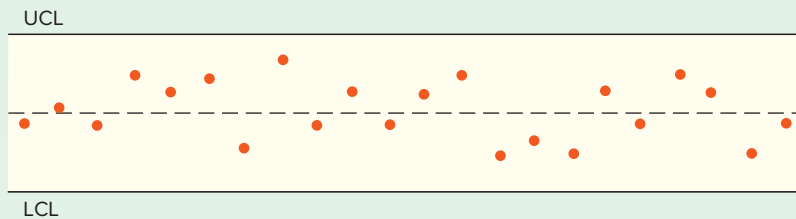

29. Use the three-step process described in the section on Using Control Charts and Runs Tests Together to decide if the following observations represent a process that is in control.

Observation	1	2	3	4	5	6	7	8	9	10	11	12
No. of errors	1	0	3	2	0	1	3	2	1	0	2	3



Toys, Inc., is a 20-year-old company engaged in the manufacture and sale of toys and board games. The company has built a reputation on quality and innovation. Although the company is one of the leaders in its field, sales have leveled off in recent years. For the most recent six-month period, sales actually declined compared with the same period last year. The production manager, Ed Murphy, attributed the lack of sales growth to “the economy.” He was prompted to undertake a number of belt-tightening moves that included cuts in production costs and layoffs in the design and product development departments. Although profits are still flat, he believes that within the next six months, the results of his decisions will be reflected in increased profits.

The vice president of sales, Joe Martin, has been concerned with customer complaints about the company’s realistic line of working-model factories, farms, and service stations. The moving parts on certain models have become disengaged and fail to operate or they operate erratically. His assistant, Keith McNally,

has proposed a trade-in program through which customers can replace malfunctioning models with new ones. McNally believes this will demonstrate goodwill and appease dissatisfied customers. He has also proposed rebuilding the trade-ins and selling them at discounted prices in the company’s retail outlet store. He doesn’t think this will take away from sales of new models. Under McNally’s program, no new staff would be needed. Regular workers would perform needed repairs during periods of seasonal slowdowns, thus keeping production at current levels.

When Steve Bukowski, a production assistant, heard Keith’s proposal, he said that a better option would be to increase inspection of finished models before they were shipped. “With 100 percent inspection, we can weed out any defective models and avoid the problem entirely.”

Take the role of a consultant who has been called in for advice by the company president, Marybeth Corbella. What do you recommend?



Tiger Tools, a division of Drillmore Industries, was about to launch a new product. Production Manager Michelle York asked her assistant, Jim Peterson, to check the capability of the oven used in the process. Jim obtained 18 random samples of 20 pieces each. The results of those samples are shown in the following table. After he analyzed the data, he concluded that the process was not capable based on a specification width of 1.44 cm.

Michelle was quite disappointed when she heard this. She had hoped that, with the introduction of the new product, her operation could run close to full capacity and regain some of its lost luster. The company had a freeze on capital expenditures of more than \$10,000, and a replacement oven would cost many times that amount. Jim Peterson worked with the oven crew to see if

perhaps different settings could produce the desired results, but they were unable to achieve any meaningful improvements.

Still not ready to concede, Michelle contacted one of her former professors and explained the problem. The professor suggested obtaining another set of samples, this time using a smaller sample size and taking more samples. Michelle then conferred with Jim, and they agreed that he should take 27 samples of five observations each. The results are shown in the following table.

Sample	Mean	Range	Sample	Mean	Range
1	45.01	.85	10	44.97	.91
2	44.99	.89	11	45.11	.84
3	45.02	.86	12	44.96	.87
4	45.00	.91	13	45.00	.86
5	45.04	.87	14	44.92	.89
6	44.98	.90	15	45.06	.87
7	44.91	.86	16	44.94	.86
8	45.04	.89	17	45.00	.85
9	45.00	.85	18	45.03	.88

Sample	Mean	Range	Sample	Mean	Range
15	45.00	.39			
16	44.95	.41			
17	44.94	.43			
18	44.94	.40			
19	44.87	.38			
20	44.95	.41			
21	44.93	.39			
22	44.96	.41			
23	44.99	.40			
24	45.00	.44			
25	45.03	.42			
26	45.04	.38			
27	45.03	.40			
1	44.96	.42			
2	44.98	.39			
3	44.96	.41			
4	44.97	.37			
5	45.02	.39			
6	45.03	.40			
7	45.04	.39			
8	45.02	.42			
9	45.08	.38			
10	45.12	.40			
11	45.07	.41			
12	45.02	.38			
13	45.01	.41			
14	44.98	.40			

Questions

Consider the following questions, and then write a brief report to Michelle summarizing your findings.

1. How did Jim conclude that the process was not capable based on his first set of samples? (*Hint:* Estimate the process standard deviation, σ , using $A_2\bar{R} \approx 3\frac{\sigma}{\sqrt{n}}$.)
2. Does the second set of samples show anything that the first set did not? Explain what and why.
3. Assuming the problem can be found and corrected, what impact do you think this would have on the capability of the process? Compute the potential process capability using the second data set.
4. If small samples can reveal something that large samples might not, why not just take small samples in every situation?

Besterfield, Dale H. *Quality Improvement*. Upper Saddle River, NJ: Pearson, 2013.

Mitra, Amitava. *Fundamentals of Quality Control and Improvement*, 4th ed. Hoboken, NJ: John Wiley & Sons, 2017.

Montgomery, Douglas C. *Introduction to Statistical Quality Control*, 7th ed. New York: John Wiley and Sons, 2013.

Quality Management Journal. ASQ. asq.org

Quality Progress. QP. www.qualityprogress.com

Summers, Donna. *Quality*, 5th ed. Upper Saddle River, NJ: Prentice Hall, 2009.

**SELECTED
BIBLIOGRAPHY AND
FURTHER READINGS**

11

CHAPTER

Aggregate Planning and Master Scheduling

LEARNING OBJECTIVES

After completing this chapter, you should be able to:

- LO11.1** Explain what aggregate planning is and how it is useful.
- LO11.2** Identify the variables decision makers have to work with in aggregate planning.
- LO11.3** Describe some of the strategies that can be used for meeting uneven demand.
- LO11.4** Describe some of the graphical and quantitative techniques planners use.
- LO11.5** Prepare aggregate plans and compute their costs.
- LO11.6** Discuss aggregate planning in services.
- LO11.7** Disaggregate an aggregate plan.
- LO11.8** Describe the master scheduling process and explain its importance.

CHAPTER OUTLINE

- | | | |
|--|---|--|
| 11.1 Introduction 466
Intermediate Planning in Perspective 466
The Concept of Aggregation 468
Dealing with Variations 468
An Overview of Aggregate Planning 469
Aggregate Planning and the Supply Chain 470
Demand and Supply Options 470 | 11.2 Basic Strategies for Meeting Uneven Demand 473
Choosing a Strategy 474 | 11.5 Disaggregating the Aggregate Plan 485 |
| 11.3 Techniques for Aggregate Planning 476
Trial-and-Error Techniques Using Graphs and Spreadsheets 476
Mathematical Techniques 480 | 11.4 Aggregate Planning in Services 484 | 11.6 Master Scheduling 486
The Master Scheduler 487 |
| | | 11.7 The Master Scheduling Process 487
Time Fences 487
Inputs 488
Outputs 488
CASE: Eight Glasses a Day (EGAD) 501 |



Afio/Shutterstock

Aggregate planning is intermediate-range capacity planning that typically covers a time horizon of 2 to 12 months, although in some companies it may extend to as much as 18 months. It is particularly useful for organizations that experience seasonal or other fluctuations in demand or capacity. The goal of aggregate planning is to achieve a production plan that will effectively utilize the organization's resources to match expected demand. Planners must make decisions on output rates, employment levels and changes, inventory levels and changes, back orders, and subcontracting in or out. They do this for products that are grouped (i.e., aggregated) into categories rather than for individual products. For instance, a company that makes lawn mowers might have multiple models of push mowers, self-propelled mowers, and riding mowers. The company would aggregate along those three lines. For example,

Category	Models
Push	2
Self-propelled	6
Riding	3

Seasonal variations in demand are quite common in many industries and public services, such as air-conditioning, fuel, public utilities, police and fire protection, and travel. These are just a few examples of industries and public services that have to deal with uneven demands. Generally speaking, organizations cannot predict exactly the quantity and timing of

LO11.1 Explain what aggregate planning is and how it is useful.

Aggregate planning
Intermediate-range capacity planning, usually covering 2 to 12 months.

continued

demands for specific products or services months in advance under these conditions. Even so, they typically must assess their capacity needs (e.g., labor, inventories) and costs months in advance in order to be able to handle demand.

Sales and operations planning

Intermediate-range decisions to balance supply and demand, integrating financial and operations planning.

Some organizations use the term “sales and operations planning” instead of aggregate planning for intermediate-range planning. Similarly, **sales and operations planning** is defined as making intermediate-range decisions to balance supply and demand, integrating financial and operations planning. Because the plan affects functions throughout the organization, it is typically prepared with inputs from sales (demand forecasts), finance (financial constraints), and operations (capacity constraints). Note

that the sales and operations plan is important planning information that will have impacts throughout the supply chain, and it should be shared with supply chain partners, who might also have valuable inputs.

11.1 INTRODUCTION

Intermediate Planning in Perspective

Organizations make capacity decisions on three levels: long term, intermediate term, and short term. Long-term decisions relate to product and service selection (i.e., determining which products or services to offer), facility size and location, equipment decisions, and layout of facilities. These long-term decisions essentially establish the capacity constraints within which intermediate planning must function. Intermediate decisions, as noted previously, relate to general levels of employment, output, and inventories, which in turn establish boundaries within which short-range capacity decisions must be made. Thus, short-term decisions essentially consist of deciding the best way to achieve desired results within the constraints resulting from long-term and intermediate-term decisions. Short-term decisions involve scheduling jobs, workers and equipment, and the like. The three levels of capacity decisions are depicted in Table 11.1. Long-term capacity decisions were covered in Chapter 5, and scheduling and related matters are covered in Chapter 16. This chapter covers intermediate capacity decisions.

Even though Toyota and Lexus cars have a variety of makes and models, they often share the same chassis and the same parts. How does this add to the company's efficiencies as a top automaker?



SPUTNIK/Alamy Stock Photo

Long-Range Plans	Intermediate Plans	Short-Range Plans
Long-term capacity }5 Location }8 Layout }6 Product design }4 Work system design }7	(This chapter) General levels of: Employment Output Finished-goods inventories Subcontracting Back orders	Detailed plans: Production lot size }13 Order quantities } Machine loading } Job assignments }16 Job sequencing } Work schedules }16

TABLE 11.1
Overview of planning levels (chapter numbers are shown)

Many business organizations develop a *business plan* that encompasses both long-term and intermediate-term planning. The business plan establishes guidelines for the organization, taking into account the organization’s strategies and policies; forecasts of overall demand for the organization’s products or services; and economic, competitive, and political conditions. A key objective in business planning is to coordinate the intermediate plans of various organization functions, such as marketing, operations, and finance. In manufacturing companies, coordination also includes engineering and materials management. Consequently, all of these functional areas must work together to formulate the aggregate plan. Aggregate planning decisions are strategic decisions that define the framework within which operating decisions will be made. They are the starting point for scheduling and production control systems. They provide input for financial plans; they involve forecasting input and demand management, and they may require changes in employment levels. If the organization is involved in *time-based competition*, it is important to incorporate some flexibility in the aggregate plan to be able to handle changing requirements promptly. As noted, the plans must fit into the framework established by the organization’s long-term goals and strategies, and the limitations established by long-term facility and capital budget decisions. The aggregate plan will guide the more detailed planning that eventually leads to a *master schedule*. Figure 11.1 illustrates the planning sequence.

Aggregate planning also can serve as an important input to other strategic decisions; for example, management may decide to add capacity when aggregate planning alternatives for temporarily increasing capacity, such as working overtime and subcontracting, are too costly.

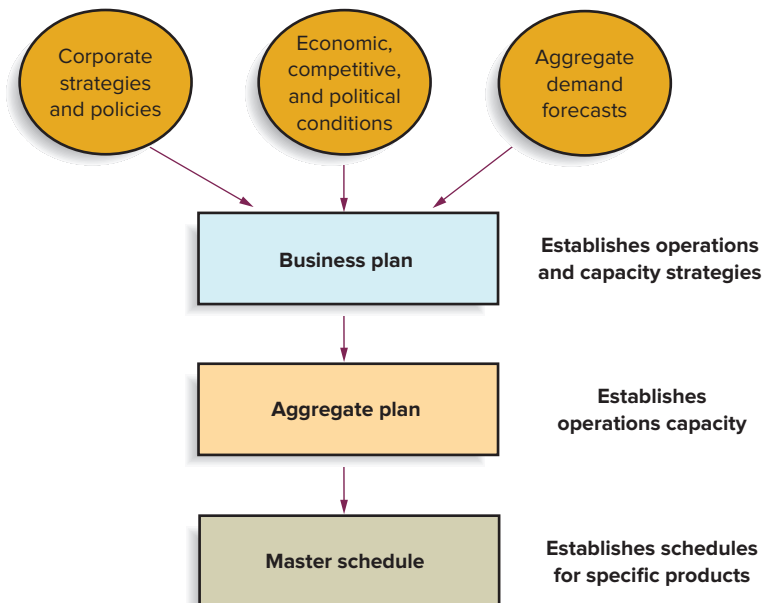

FIGURE 11.1
Planning sequence

The Concept of Aggregation

Aggregate planning is essentially a “big-picture” approach to planning. Planners usually try to avoid focusing on individual products or services—unless the organization has only one major product or service. Instead, they focus on a group of similar products or services, or sometimes an entire product or service line. For example, planners in a company producing ultra high-definition televisions would not concern themselves with the different size televisions the company offers. Instead, planners would lump all models together and deal with them as though they were a single product, hence the term *aggregate* planning. Thus, when fast-food companies such as McDonald’s, Burger King, or Wendy’s plan employment and output levels, they don’t try to determine how demand will be broken down into the various menu options they offer; they focus on overall demand and the overall capacity they want to provide. Aggregating generally provides a more accurate forecast than what would be achieved by focusing on individual items.

Now consider how aggregate planning might work in a large department store. Space allocation is often an aggregate decision. That is, a manager might decide to allocate 20 percent of the available space in the clothing department to women’s sportswear, 30 percent to juniors, and so on, without regard for what brand names will be offered or how much of juniors will be jeans. The aggregate measure might be square feet of space or racks of clothing.

For purposes of aggregate planning, it is often convenient to think of capacity in terms of labor hours or machine hours per period, or output rates (barrels per period, units per period), without worrying about how much of a particular item will actually be involved. This approach frees planners to make general decisions about the use of resources without having to get into the complexities of individual product or service requirements. Product groupings make the problem of obtaining an acceptable unit of aggregation easier because product groupings may lend themselves to the same aggregate measures.

Why do organizations need to do aggregate planning? The answer is twofold. One part is related to *planning*: It takes time to implement plans. For instance, if plans call for hiring (and training) new workers, that will take time. The second part is strategic: *Aggregation* is important because it is not possible to predict with any degree of accuracy the timing and volume of demand for individual items. So if an organization were to “lock in” on individual items, it would lose the flexibility to respond to the market.

Generally speaking, aggregate planning is connected to the budgeting process. Most organizations plan their financial requirements annually on a department-by-department basis.

Finally, aggregate planning is important because it can help synchronize flow throughout the supply chain. It affects costs, equipment utilization, employment levels, and customer satisfaction.

A key issue in aggregate planning is how to handle variations.

Dealing with Variations

As in other areas of business management, variations in either supply or demand can occur. Minor variations are usually not a problem, but large variations generally have a major impact on the ability to match supply and demand, so they must be dealt with. Most organizations use rolling 3-, 6-, 9-, and 12-month forecasts—forecasts that are updated periodically—rather than relying on a once-a-year forecast. This allows planners to take into account any changes in either expected demand or expected supply and to develop revised plans.

Some businesses tend to exhibit a fair degree of stability, whereas in others, variations are more the norm. In those instances, a number of strategies are used to counter variations. One is to maintain a certain amount of excess capacity to handle increases in demand. This strategy makes sense when the opportunity cost of lost revenue greatly exceeds the cost of maintaining excess capacity. Another strategy is to maintain a degree of flexibility in dealing with changes. That might involve hiring temporary workers and/or working overtime when needed. Organizations that experience seasonal demands typically use this approach. Some of the design strategies mentioned in Chapter 4, such as delayed differentiation and modular design, may also be options. Still another strategy is to wait as long as possible before committing to a certain level of supply capability. This might involve scheduling products or services

with known demands first, which allows some time to pass, shortening the time horizon, and perhaps enabling demands for the remaining products or services to become less uncertain.

An Overview of Aggregate Planning

Aggregate planning begins with a forecast of aggregate demand for the intermediate range. This is followed by a general plan to meet demand requirements by setting output, employment, and finished-goods inventory levels or service capacities. Managers might consider a number of plans, each of which must be examined in light of feasibility and cost. If a plan is reasonably good but has minor difficulties, it may be reworked. Conversely, a poor plan should be discarded, and alternative plans considered until an acceptable one is uncovered. An aggregate production plan is essentially the output of aggregate planning.

Aggregate plans are updated periodically, often monthly, to take into account updated forecasts and other changes. This results in a *rolling planning horizon* (i.e., the aggregate plan always covers the next 12 to 18 months).

Demand and Supply. Aggregate planners are concerned with the *quantity* and the *timing* of expected demand. If total expected demand for the planning period is much different from available capacity over that same period, the major approach of planners will be to try to achieve a balance by altering capacity, demand, or both. On the other hand, even if capacity and demand are approximately equal for the planning horizon as a whole, planners may still be faced with the problem of dealing with uneven demand *within* the planning interval. In some periods, expected demand may exceed projected capacity; in others, expected demand may be less than projected capacity, and in some periods the two may be equal. The task of aggregate planners is to achieve rough equality of demand and capacity over the entire planning horizon. Moreover, planners are usually concerned with minimizing the cost of the aggregate plan, although cost is not the only consideration.

Inputs to Aggregate Planning. Effective aggregate planning requires good *information*. First, the available resources over the planning period must be known. Then, a forecast of expected demand must be available. Finally, planners must take into account any policies regarding changes in employment levels (e.g., some organizations view layoffs as extremely undesirable, so they would use that only as a last resort).

Table 11.2 lists the major inputs to aggregate planning.

Companies in the travel industry and some other industries often experience duplicate orders from customers who make multiple reservations but only intend to keep at most one of them. This makes capacity planning all the more difficult.

Inputs	Outputs
Resources	Total cost of a plan
Workforce/production rates	Projected levels of
Facilities and equipment	Inventory
Demand forecast	Output
Policies on workforce changes	Employment
Subcontracting	Subcontracting
Overtime	Backordering
Inventory levels/changes	
Back orders	
Costs	
Inventory carrying cost	
Back orders	
Hiring/firing	
Overtime	
Inventory changes	
Subcontracting	

TABLE 11.2
Aggregate planning inputs and outputs



We've all heard about someone who booked seats on two airlines, or reserved two hotel rooms, usually because travel plans weren't firmed up, but the person didn't want to miss out on the trip. Later, the person canceled one set of reservations. This sort of duplicate ordering isn't just limited to the travel industry. Restaurants, theaters, and some sports events sometimes encounter this problem. The trouble is, companies base their capacity planning on demand estimates, and when there are numerous duplicate orders, it is easy to overestimate demand and end up with excess capacity. In some instances, this has led companies to expand at a time when demand was actually leveling off or even decreasing! The problem is further compounded if companies conclude that canceled orders reflect customers' reluctance to wait, and respond by *adding* capacity when, in fact, order cancellation may actually reflect duplicate ordering.

Some semiconductor companies downplay data on bookings because it is too difficult to distinguish between duplicate orders and actual demand.

Yet it is important to account for double orders. Otherwise, by counting duplicate orders as true demand, you overestimate the demand rate, and by counting the cancellations of duplicate orders as lost sales, you overestimate customers' sensitivity to delay, and then you wind up with excess capacity.

"The optimal level of capacity increases with customers' sensitivity to delay, so estimating customers' sensitivity to delay is a very important part of the puzzle."

Duplicate orders can make capacity planning very difficult. The key is to carefully estimate both the rate of duplicate ordering and the degree of order cancellation that can be attributed to duplicate ordering.

Source: Based on Mor Armony and Erica L. Plambeck, "The Impact of Duplicate Orders on Demand Estimation and Capacity Investment." GSB Research Paper #1740, Graduate School of Business, Stanford University, June 2002.

Aggregate Planning and the Supply Chain

It is essential to take supply chain capabilities into account when doing aggregate planning, to assure that there are no quantity or timing issues that need to be resolved. While this is particularly true if new or changed goods or services are involved, it is also true even when no changes are planned. Supply chain partners should be consulted during the planning stage so that any issues or advice they may have can be taken into account, and they should be informed when plans have been finalized.

Demand and Supply Options

Aggregate planning strategies can pertain to demand, capacity, or both. Demand strategies are intended to alter demand so that it matches capacity. Capacity strategies involve altering capacity so it matches demand. *Mixed* strategies involve both of these approaches.

LO11.2 Identify the variables decision makers have to work with in aggregate planning.

Demand Options. Demand options include pricing, promotions, using back orders (delaying order filling), and creating new demand.

1. **Pricing.** Pricing differentials are commonly used to shift demand from peak periods to off-peak periods. Some hotels, for example, offer lower rates for weekend stays, and some airlines offer lower fares for night travel. Movie theaters may offer reduced rates for matinees, and some restaurants offer "early bird specials" in an attempt to shift some of the heavier dinner demand to an earlier time that traditionally has less traffic. Some restaurants also offer smaller portions at reduced rates, and most have smaller portions and prices for children. To the extent that pricing is effective, demand will be shifted so it corresponds more closely to capacity, albeit for an *opportunity cost* that represents the lost profit stemming from capacity insufficient to meet demand during certain periods.

An important factor to consider is the *degree* of price elasticity for the product or service: The more the elasticity, the more effective pricing will be in influencing demand patterns.

2. **Promotion.** Advertising and other forms of promotion, such as displays and direct marketing, can sometimes be very effective in shifting demand so it conforms more closely to capacity. Obviously, timing of these efforts and knowledge of response rates

and response patterns will be needed to achieve the desired results. Unlike pricing policy, there is much less control over the timing of demand, so there is the risk that promotion can worsen the condition it was intended to improve, by bringing in demand at the wrong time, further stressing capacity.

3. **Back orders.** An organization can shift demand fulfillment to other periods by allowing back orders. That is, orders are taken in one period and deliveries promised for a later period. The success of this approach depends on how willing customers are to wait for delivery. Moreover, the costs associated with back orders can be difficult to pin down because they would include lost sales, annoyed or disappointed customers, and perhaps additional paperwork.
4. **New demand.** Many organizations are faced with the problem of having to provide products or services for peak demand in situations where demand is very uneven. For instance, demand for bus transportation tends to be more intense during the morning and late afternoon rush hours but much lighter at other times. Creating new demand for buses at other times (e.g., trips by schools, clubs, and senior citizen groups) would make use of the excess capacity during those slack times. Similarly, many fast-food restaurants are open for breakfast to use their capacities more fully, and some landscaping firms in northern climates use their equipment during the winter months for snow removal. Manufacturing firms that experience seasonal demands for certain products (e.g., snowblowers) are sometimes able to develop a demand for a complementary product (e.g., lawn mowers, garden equipment) that makes use of the same production processes. They thereby achieve a more consistent use of labor, equipment, and facilities. Another option may be “insourcing” work from another organization.

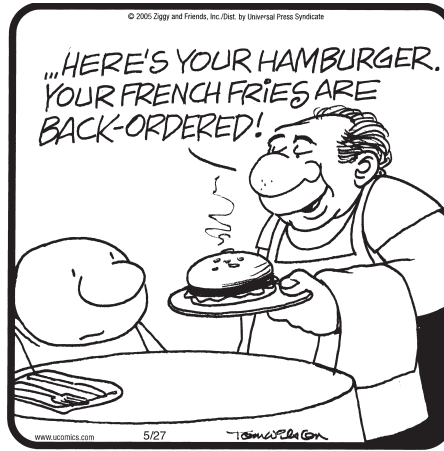

ZIGGY ©2000 ZIGGY AND FRIENDS, INC.
Reprinted with permission of UNIVERSAL UCLICK. All rights reserved.

Supply Options. Supply options include hiring/laying off workers, overtime/slack time, part-time or temporary workers, inventories, and subcontractors.

1. **Hire and lay off workers.** The extent to which operations are labor intensive determines the impact that changes in the workforce level will have on capacity. The resource requirements of each worker also can be a factor. For instance, if a supermarket usually has 10 of 14 checkout lines operating, an additional four checkout workers could be added. Hence, the ability to add workers is constrained at some point by other resources needed to support the workers. Conversely, there may be a lower limit on the number of workers needed to maintain a viable operation (e.g., a skeleton crew).

Union contracts may restrict the amount of hiring and laying off a company can do. Moreover, because laying off can present serious problems for workers, some firms have policies that either prohibit or limit downward adjustments to a workforce. On the other hand, hiring presumes an available supply of workers. This may change from time to time and, at times of low supply, have an impact on the ability of an organization to pursue this approach.

Another consideration is the skill level of workers. Highly skilled workers are generally more difficult to find than lower-skilled workers, and recruiting them involves greater costs. So the usefulness of this option may be limited by the need for highly skilled workers.

The use of hiring and laying off entails certain costs. Hiring costs include recruitment, screening, and training to bring new workers “up to speed.” And quality may suffer. Some savings may occur if workers who have recently been laid off are rehired. Layoff costs include severance pay, unemployment costs, the cost of realigning the

remaining workforce, potential bad feelings toward the firm on the part of workers who have been laid off, and some loss of morale for workers who are retained (i.e., despite company assurances, some workers will believe that in time they too will be laid off).

An increasing number of organizations view workers as assets rather than as variable costs, and would not consider this approach. Instead, they might use slack time for other purposes.

2. **Overtime/slack time.** Use of overtime or slack time is a less severe method for changing capacity than hiring and laying off workers, and it can be used across the board or selectively as needed. It also can be implemented more quickly than hiring and laying off and allows the firm to maintain a steady base of employees. The use of overtime can be especially attractive in dealing with seasonal demand peaks by reducing the need to hire and train people who will have to be laid off during the off-season. Overtime also permits the company to maintain a skilled workforce and employees to increase earnings, and companies may save money because fringe and other benefits are generally fixed. Moreover, in situations with crews, it is often necessary to use a full crew rather than to hire one or two additional people. Thus, having the entire crew work overtime would be preferable to hiring extra people.

It should be noted that some union contracts allow workers to refuse overtime. In those cases, it may be difficult to muster a full crew to work overtime or to get an entire production line into operation after regular hours. Although workers often like the additional income overtime can generate, they may not appreciate having to work on short notice or the fluctuations in income that result. Still other considerations relate to the fact that overtime often results in lower productivity, poorer quality, more accidents, and increased payroll costs, whereas idle time results in less efficient use of machines and other fixed assets.

The use of slack when demand is less than capacity can be an important consideration. Some organizations use this time for training. It also can give workers time for problem solving and process improvement, while retraining skilled workers.

3. **Part-time workers.** In certain instances, the use of part-time workers is a viable option—much depends on the nature of the work, the training and skills needed, and union agreements. Seasonal work requiring low-to-moderate job skills lends itself to part-time workers, who generally cost less than regular workers in hourly wages and fringe benefits. However, unions may regard such workers unfavorably because they typically do not pay union dues and may lessen the power of unions. Department stores, restaurants, and supermarkets make use of part-time workers. So do parks and recreation departments, resorts, travel agencies, hotels, and other service organizations with seasonal demands. In order to be successful, these organizations must be able to hire part-time employees when they are needed.

Some companies use contract workers, also called *independent contractors*, or “gig” workers, to fill certain needs. Although they are not regular employees, often they work alongside regular workers. In addition to having different pay scales and no benefits, they can be added or subtracted from the workforce with greater ease than regular workers, giving companies great flexibility in adjusting the size of the workforce.

4. **Inventories.** The use of finished-goods inventories allows firms to produce goods in one period and sell or ship them in another period, although this involves holding or carrying those goods as inventory until they are needed. The cost includes not only storage costs and the cost of money tied up that could be invested elsewhere, but also the cost of insurance, obsolescence, deterioration, spoilage, breakage, and so on. In essence, inventories can be built up during periods when production capacity exceeds demand and drawn down in periods when demand exceeds production capacity.

This method is more amenable to manufacturing than to service industries because manufactured goods can be stored, whereas services generally cannot. However, an analogous approach used by services is to make efforts to streamline services (e.g., standard forms) or otherwise do a portion of the service during slack periods (e.g., organize



Geoff Robinson Photography/Shutterstock

Amazon is very aggressive about managing its inventory levels. This may mean that rarely ordered items are not kept in inventory and may require time to source from a supplier. It also means that Amazon tries to move inventory out to customers as quickly as possible.

the workplace). In spite of these possibilities, services tend not to make much use of inventories to alter capacity requirements.

5. **Subcontracting.** Subcontracting enables planners to acquire temporary capacity, although it affords less control over the output and may lead to higher costs and quality problems. The question of whether to make or buy (i.e., in manufacturing) or to perform a service or hire someone else to do the work generally depends on factors such as available capacity, relative expertise, quality considerations, cost, and the amount and stability of demand.

Conversely, in periods of excess capacity, an organization may subcontract *in*—that is, conduct work for another organization. As an alternative to subcontracting, an organization might consider *outsourcing*: contracting with another organization to supply some portion of the goods or services on a regular basis.

11.2 BASIC STRATEGIES FOR MEETING UNEVEN DEMAND

As you see, managers have a wide range of decision options they can consider for achieving a balance of demand and capacity in aggregate planning. Because the options most suited to influencing demand fall more in the realm of marketing than in operations (with the exception of backlogging), we shall concentrate on the capacity options, which are in the realm of operations but include the use of back orders.

Aggregate planners might adopt a number of strategies. Some of the more prominent ones are the following:

- Maintain a level workforce (level capacity)
- Maintain a steady output rate (level capacity)
- Match demand period by period (chase demand)
- Use a combination of decision variables

While other strategies might be considered, these will suffice to give you a sense of how aggregate planning operates in a vast number of organizations. The first three strategies are “pure” strategies because each has a single focal point; the last strategy is “mixed” because

LO11.3 Describe some of the strategies that can be used for meeting uneven demand.

Level capacity strategy

Maintaining a steady rate of regular-time output while meeting variations in demand by a combination of options.

Chase demand strategy

Matching capacity to demand; the planned output for a period is set at the expected demand for that period.

it lacks the single focus. Under a **level capacity strategy**, variations in demand are met by using some combination of inventories, overtime, part-time workers, subcontracting, and back orders, while maintaining a steady rate of output. Matching capacity to demand implies a **chase demand strategy**; the planned output for any period would be equal to the expected demand for that period.

Many organizations regard a level workforce as very appealing. Because workforce changes through hiring and laying off can have a major impact on the lives and morale of employees and can be disruptive for managers, organizations often prefer to handle uneven demand in other ways. Moreover, changes in workforce size can be very costly, and there is always the risk that there will not be a sufficient pool of workers with the appropriate skills when needed. Aside from these considerations, such changes can involve a significant amount of paperwork. Unions tend to favor a level workforce because the freedom to hire and lay off workers diminishes union strengths.

To maintain a constant level of output and still satisfy varying demand, an organization must resort to some combination of subcontracting, backlogging, and use of inventories to absorb fluctuations. Subcontracting requires an investment in evaluating sources of supply, as well as possible increased costs, less control over output, and perhaps quality considerations. Backlogs can lead to lost sales, increased record keeping, and lower levels of customer service. Allowing inventories to absorb fluctuations can entail substantial costs by having money tied up in inventories, having to maintain relatively large storage facilities, and incurring other costs related to inventories. Furthermore, inventories are not usually an alternative for service-oriented organizations. However, there are certain advantages, such as minimum costs of recruitment and training, minimum overtime and idle-time costs, fewer morale problems, and stable use of equipment and facilities.

A chase demand strategy presupposes a great deal of ability and willingness on the part of managers to be flexible in adjusting to demand. A major advantage of this approach is that inventories can be kept relatively low, which can yield substantial savings for an organization. A major disadvantage is the lack of stability in operations—the atmosphere is one of dancing to demand's tune. Also, when forecast and reality differ, morale can suffer, because it quickly becomes obvious to workers and managers that efforts have been wasted. Figure 11.2 provides a comparison of the two strategies, using a varying demand pattern to highlight the differences in the two approaches. The same demand pattern is used for each approach. In the upper portion of the figure the pattern is shown. Notice that there are three situations: (1) demand and capacity are equal; (2) demand is less than capacity; and (3) demand exceeds capacity.

The middle portion of the figure illustrates what happens with a chase approach. When normal capacity would exceed demand, capacity is cut back to match demand. Then, when demand exceeds normal capacity, the chase approach is to temporarily increase capacity to match demand.

The bottom portion of the figure illustrates the level-output strategy. When demand is less than capacity, output continues at normal capacity, and the excess output is put into inventory in anticipation of the time when demand exceeds capacity. When demand exceeds capacity, inventory is used to offset the shortfall in output.

Organizations may opt for a strategy that involves some combination of the pure strategies. This allows managers greater flexibility in dealing with uneven demand and perhaps in experimenting with a wide variety of approaches. However, the absence of a clear focus may lead to an erratic approach and confusion on the part of employees.

Choosing a Strategy

Whatever strategy an organization is considering, factors such as *company policy*, *flexibility*, and *costs* are important. Company policy may set constraints on the available options or the extent to which they can be used. For instance, company policy may discourage layoffs except under extreme conditions. Subcontracting may not be a viable alternative due to the desire to maintain secrecy about some aspect of the manufacturing of the product (e.g., a secret formula or blending process). Union agreements often impose restrictions. For example, a union contract may specify both minimum and maximum numbers of hours part-time workers can

FIGURE 11.2 A varying demand pattern and a comparison of a chase demand strategy versus a level strategy

A. A possible uneven demand pattern

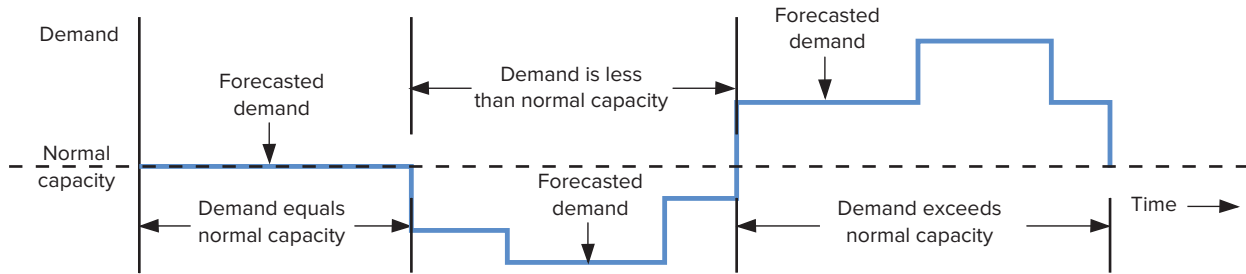

B. Two strategies

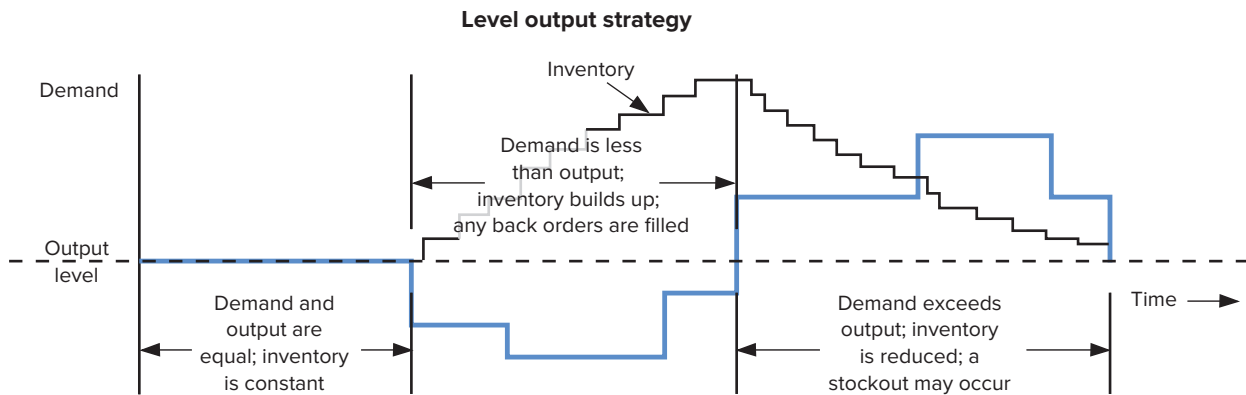
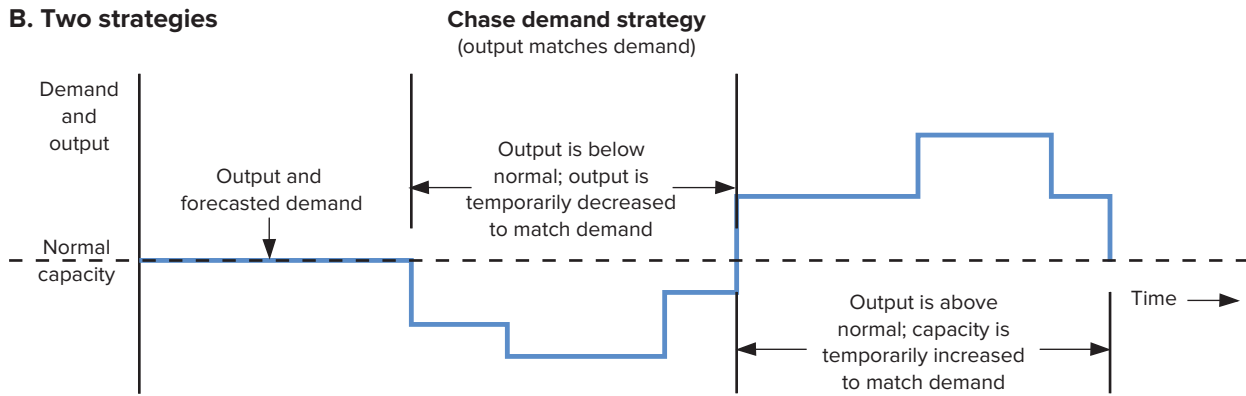

be used. The degree of flexibility needed to use the chase approach may not be present for companies designed for high, steady output, such as refineries and auto assembly plants.

It is important to align plans with an organization’s strategies. For example, if an organization’s strategy includes excellent customer service, having a backlog of orders that results in making customers wait would not be good. Or, if an organization prides itself on how it treats employees, hiring/firing would not be high on its lists of options. And the option of building inventories during slow times must involve taking into account available storage space, as well as the costs related to having inventory on hand (heat, light, security, theft, product deterioration, and the opportunity costs associated with the money tied up in inventory), money that could be used for other purposes.

As a rule, aggregate planners seek to match supply and demand within the constraints imposed on them by policies or agreements and at minimum cost. They usually evaluate alternatives in terms of their overall costs. Table 11.3 compares reactive strategies. In the next section, a number of techniques for aggregate planning are described and presented with some examples of cost evaluation of alternative plans.

TABLE 11.3

Comparison of reactive strategies

Chase approach

Capacities (workforce levels, output rates, etc.) are adjusted to match demand requirements over the planning horizon. A chase strategy works best when inventory carrying costs are high and costs of changing capacity are low.

Advantages:

Investment in inventory is low.

Labor utilization is kept high.

Disadvantage:

The cost of adjusting output rates and/or workforce levels.

Level approach

Capacities (workforce levels, output rates, etc.) are kept constant over the planning horizon. A level strategy works best when inventory carrying costs and backlog costs are relatively low.

Advantage:

Stable output rates and workforce levels.

Disadvantages:

Greater inventory costs.

Increased overtime and idle time.

Resource utilizations that vary over time.

11.3 TECHNIQUES FOR AGGREGATE PLANNING

LO11.4 Describe some of the graphical and quantitative techniques planners use.

Numerous techniques are available to help with the task of aggregate planning. Generally, they fall into one of two categories: informal trial-and-error techniques and mathematical techniques. In practice, informal techniques are more frequently used. However, a considerable amount of research has been devoted to mathematical techniques, and even though they are not as widely used, they often serve as a basis for comparing the effectiveness of alternative techniques for aggregate planning. Thus, it will be instructive to briefly examine them as well as the informal techniques.

A general procedure for aggregate planning consists of the following steps:

1. Determine demand for each period.
2. Determine capacities (regular time, overtime, subcontracting) for each period.
3. Identify company or departmental policies that are pertinent (e.g., maintain a safety stock of 5 percent of demand, maintain a reasonably stable workforce).
4. Determine unit costs for regular time, overtime, subcontracting, holding inventories, back orders, layoffs, and other relevant costs.
5. Develop alternative plans and compute the cost for each.
6. If satisfactory plans emerge, select the one that best satisfies objectives. Otherwise, return to step 5.

It can be helpful to use a worksheet or spreadsheet, such as the one illustrated in Table 11.4, to summarize demand, capacity, and cost for each plan. In addition, graphs can be used to guide the development of alternatives.

Trial-and-Error Techniques Using Graphs and Spreadsheets

Trial-and-error approaches consist of developing simple tables or graphs that enable planners to visually compare projected demand requirements with existing capacity. Alternatives are usually evaluated in terms of their overall costs. The chief disadvantage of such techniques is that they do not necessarily result in the optimal aggregate plan.

Two examples illustrate the development and comparison of aggregate plans. In the first example, regular output is held steady, with inventory absorbing demand variations.

TABLE 11.4
Worksheet/spreadsheet

Period	1	2	3	4	5	Total
Forecast						
Output						
Regular time						
Overtime						
Subcontract						
Output – Forecast						
Inventory						
Beginning						
Ending						
Average						
Backlog						
Costs						
Output						
Regular						
Overtime						
Subcontract						
Hire/Lay off						
Inventory						
Back orders						
Total						

In the second example, a lower rate of regular output is used, supplemented by the use of overtime. In both examples, some backlogs are allowed to build up.

These examples and other examples and problems in this chapter are based on the following assumptions:

- The regular output capacity is the same in all periods. No allowance is made for holidays, different numbers of workdays in different months, and so on. This assumption simplifies computations.
- Cost (back order, inventory, subcontracting, etc.) is a linear function composed of unit cost and number of units. This often has a reasonable approximation to reality, although there may be only narrow ranges over which this is true. Cost is sometimes more of a step function.
- Plans are feasible; that is, sufficient inventory capacity exists to accommodate a plan, subcontractors with appropriate quality and capacity are standing by, and changes in output can be made as needed.
- All costs associated with a decision option can be represented by a lump sum or by unit costs that are independent of the quantity involved. Again, a step function may be more realistic; but for purposes of illustration and simplicity, this assumption is appropriate.
- Cost figures can be reasonably estimated and are constant for the planning horizon.
- Inventories are built up and drawn down at a uniform rate, and output occurs at a uniform rate throughout each period. However, backlogs are treated as if they exist for an entire period, even though in periods where they initially appear, they would tend to build up toward the end of the period. Hence, this assumption is a bit unrealistic for some periods, but it simplifies computations.

In the examples and problems in this chapter, we use the following relationships to determine the number of workers, the amount of inventory, and the cost of a particular plan.

The number of workers available in any period is calculated as follows:

$$\begin{matrix} \text{Number of} & \text{Number of} & \text{Number of new} & \text{Number of laid-off} \\ \text{workers in} & \text{workers at end of} & \text{workers at start of} & \text{workers at start of} \\ \text{a period} & \text{the previous period} & \text{the period} & \text{the period} \end{matrix} \begin{matrix} = \\ + \\ - \end{matrix}$$

Note: An organization would not hire and lay off simultaneously, so at least one of the last two terms will equal zero.

The amount of inventory at the end of a given period is calculated as follows:

$$\begin{matrix} \text{Inventory} & \text{Inventory} & \text{Production} & \text{Amount used to} \\ \text{at the end of} & \text{at end of the} & \text{in the} & \text{satisfy demand in the} \\ \text{a period} & \text{previous period} & \text{current period} & \text{current period} \end{matrix} \begin{matrix} = \\ + \\ - \end{matrix}$$

The average inventory for a period is equal to

$$\frac{\text{Beginning inventory} + \text{Ending inventory}}{2}$$

The cost of a particular plan for a given period can be determined by summing the appropriate costs:

$$\text{Cost for a period} = \text{Output cost (Reg + OT + Subcontract)} = \text{Hire/lay-off cost} + \text{Inventory cost} + \text{Backorder cost}$$

LO11.5 Prepare aggregate plans and compute their costs.

The appropriate costs are calculated as follows:

Type of Cost	How to Calculate
Output	
Regular	Regular cost per unit × Quantity of regular output
Overtime	Overtime cost per unit × Overtime quantity
Subcontract	Subcontract cost per unit × Subcontract quantity
Hire/layoff	
Hire	Cost per hire × Number hired
Layoff	Cost per layoff × Number laid off
Inventory	Carrying cost per unit × Average inventory
Back order	Backorder cost per unit × Number of backorder units

The following examples are only two of many possible options that could be tried. Perhaps some of the others would result in a lower cost. With trial and error, you can never be completely sure you have identified the lowest-cost alternative unless every possible alternative is evaluated. Of course, the purpose of these examples is to illustrate the process of developing and evaluating an aggregate plan rather than to find the lowest-cost plan. Problems at the end of the chapter cover still other alternatives.

In practice, successful achievement of a good plan depends on the resourcefulness and persistence of the planner. Computer software such as the Excel templates that accompany this book can eliminate the computational burden of trial-and-error techniques.

EXAMPLE 1

Preparing an Aggregate Plan



mhhe.com/stevenson14e

Planners for a company that makes several models of skateboards are about to prepare the aggregate plan that will cover six periods. They have assembled the following information:

Period	1	2	3	4	5	6	Total
Forecast	200	200	300	400	500	200	1,800
Costs							
Output							
Regular time	= \$20 per skateboard						
Overtime	= \$30 per skateboard						
Subcontract	= \$60 per skateboard						
Inventory	= \$1 per skateboard per period on average inventory						
Back orders	= \$5 per skateboard per period						

They now want to evaluate a plan that calls for a steady rate of regular-time output, mainly using inventory to absorb the uneven demand but allowing some backlog. Overtime and subcontracting are not used because they want steady output. They intend to start with zero inventory on hand in the first period. Prepare an aggregate plan and determine its cost using the preceding information. Assume a level output rate of 300 units (skateboards) per period with regular time (i.e., $1,800/6 = 300$). Note that the planned ending inventory is zero. There are two workers, and each can produce 150 skateboards per period.

Period	1	2	3	4	5	6	Total
Forecast	200	200	300	400	500	200	1,800
Output							
Regular	300	300	300	300	300	300	1,800
Overtime	—	—	—	—	—	—	
Subcontract	—	—	—	—	—	—	
Output 2 Forecast	100	100	0	(100)	(200)	100	0
Inventory							
Beginning	0	100	200	200	100	0	
Ending	100	200	200	100	0	0	
Average	50	150	200	150	50	0	600
Backlog	0	0	0	0	100	0	100
Costs							
Output							
Regular	\$6,000	6,000	6,000	6,000	6,000	6,000	\$36,000
Overtime	—	—	—	—	—	—	
Subcontract	—	—	—	—	—	—	
Hire/Lay off	—	—	—	—	—	—	
Inventory	\$ 50	150	200	150	50	0	\$ 600
Back orders	\$ 0	0	0	0	500	0	\$ 500
Total	\$6,050	6,150	6,200	6,150	6,550	6,000	\$37,100

SOLUTION

Note that the total regular-time output of 1,800 units equals the total expected demand. Ending inventory equals beginning inventory plus or minus the quantity Output – Forecast. If Output – Forecast is negative, inventory is decreased in that period by that amount. If insufficient inventory exists, a backlog equal to the shortage amount appears, as in period 5. This is taken care of using the excess output in period 6.

The costs were computed as follows: Regular cost in each period equals 300 units \times \$20 per unit or \$6,000. Inventory cost equals average inventory \times \$1 per unit. Backorder cost is \$5 per unit. The total cost for this plan is \$37,100.

Note that the first two quantities in each column are givens. The remaining quantities in the upper portion of the table were determined working down each column, beginning with the first column. The costs were then computed based on the quantities in the upper part of the table.

Very often, graphs can be used to guide the development of alternatives. Some planners prefer cumulative graphs, while others prefer to see a period-by-period breakdown of a plan. For instance, Figure 11.3 shows a cumulative graph for a plan with steady output (the slope of the dashed line represents the production rate) and inventory absorption of demand variations. Figure 11.2 is an example of a period-by-period graph. The obvious advantage of a graph is that it provides a visual portrayal of a plan. The preference of the planner determines which of these two types of graphs is chosen.

Developing and Comparing Aggregate Plans

After reviewing the plan developed in the preceding example, planners have decided to develop an alternative plan. They have learned that one person is about to retire from the company. Rather than replace that person, they would like to stay with the smaller

EXAMPLE 2

mhhe.com/stevenson14e

workforce and use overtime to make up for the lost output. The reduced regular-time output is 280 units per period. The maximum amount of overtime output per period is 40 units. Develop a plan and compare it to the previous one.

FIGURE 11.3
A cumulative graph

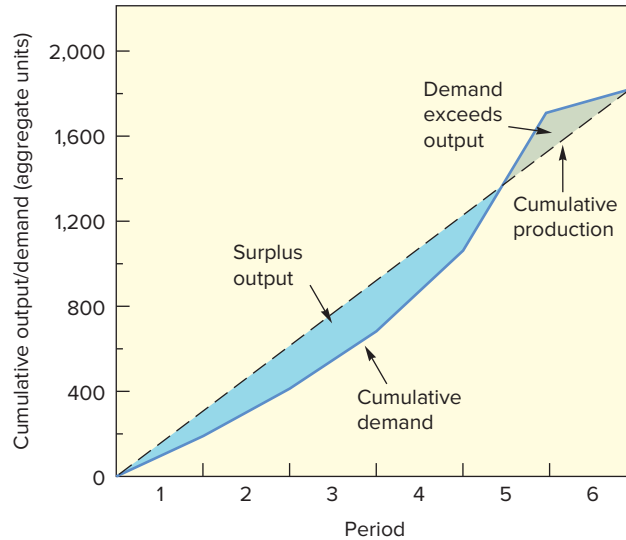

SOLUTION

Period	1	2	3	4	5	6	Total
Forecast	200	200	300	400	500	200	1,800
Output							
Regular	280	280	280	280	280	280	1,680
Overtime	0	0	40	40	40	0	120
Subcontract	—	—	—	—	—	—	—
Output – Forecast	80	80	20	(80)	(180)	80	0
Inventory							
Beginning	0	80	160	180	100	0	
Ending	80	160	180	100	0	0	
Average	40	120	170	140	50	0	520
Backlog	0	0	0	0	80	0	80
Costs							
Output							
Regular	\$560	560	560	560	560	560	\$3,360
Overtime	0	0	120	120	120	0	\$ 360
Subcontract	—	—	—	—	—	—	—
Hire/Lay off	—	—	—	—	—	—	—
Inventory	40	120	170	140	50	0	\$ 520
Back orders	\$ 0	0	0	0	400	0	\$ 400
Total	\$600	680	850	820	1,130	560	\$4,640

The amount of overtime that must be scheduled has to make up for a lost output of 20 units per period for six periods, which is 120. This is scheduled toward the center of the planning horizon because that is where the bulk of demand occurs. Although other amounts and time periods could be used as long as the total equals 120, scheduling it earlier would increase inventory carrying costs; scheduling it later would increase the backlog cost.

Overall, the total cost for this plan is \$4,640, which is \$60 less than the previous plan. Regular-time production cost and inventory cost are down, but there is overtime cost. However, this plan achieves savings in backorder cost, making it somewhat less costly overall than the plan in Example 1.

Mathematical Techniques

A number of mathematical techniques have been developed to handle aggregate planning. They range from mathematical programming models to heuristic and computer search models. This section briefly describes some of the better-known techniques.

Linear Programming. Linear programming (LP) models are methods for obtaining optimal solutions to problems involving the allocation of scarce resources in terms of cost minimization or profit maximization. With aggregate planning, the goal is usually to minimize the sum of costs related to regular labor time, overtime, subcontracting, carrying inventory, and costs associated with changing the size of the workforce. Constraints involve the capacities of the workforce, inventories, and subcontracting.

The problem can be formulated as a transportation-type programming model so as to obtain aggregate plans that would match capacities with demand requirements and minimize costs. In order to use this approach, planners must identify capacity (supply) of regular time, overtime, subcontracting, and inventory on a period-by-period basis, as well as related costs of each variable.

Table 11.5 shows the notation and setup of a transportation table. Note the systematic way that costs change as you move across a row from left to right. Regular cost, overtime cost, and subcontracting cost are at their lowest when the output is consumed (i.e., delivered, etc.) in the same period it is produced (at the intersection of the period 1 row and the column for regular cost, at the intersection of the period 2 row and the column for regular cost, and so on). If goods are made available in one period but then carried over to later periods (i.e., moving across a row), holding costs are incurred at the rate of h per period. Thus, holding goods for two periods results in a unit cost of $2h$, whether or not the goods came from regular production, overtime, or subcontracting. Conversely, with back orders, the unit cost increases as you move across a row from right to left, beginning at the intersection of a row and column for the same period (e.g., period 3). For instance, if some goods are produced in period 3 to satisfy back orders from period 2, a unit backorder cost of b is incurred. And if goods in period 3 are used to satisfy back orders two periods earlier (e.g., from period 1), a unit cost of $2b$ is incurred. Unused capacity is generally given a unit cost of 0, although it is certainly possible to insert an actual cost if that is relevant. Finally, beginning inventory is

TABLE 11.5 Transportation notation for aggregate planning

		Period 1	Period 2	Period 3	...	Ending inventory period n	Unused capacity	Capacity
Period 1	Beginning inventory	0	h	$2h$...	$(n-1)h$	0	I_0
	Regular time	r	$r+h$	$r+2h$...	$r+(n-1)h$	0	R_1
	Overtime	t	$t+h$	$t+2h$...	$t+(n-1)h$	0	O_1
	Subcontract	s	$s+h$	$s+2h$...	$s+(n-1)h$	0	S_1
Period 2	Regular time	$r+b$	r	$r+h$...	$r+(n-2)h$	0	R_2
	Overtime	$t+b$	t	$t+h$...	$t+(n-2)h$	0	O_2
	Subcontract	$s+b$	s	$s+h$...	$s+(n-2)h$	0	S_2
Period 3	Regular time	$r+2b$	$r+b$	r	...	$r+(n-3)h$	0	R_3
	Overtime	$t+2b$	$t+b$	t	...	$t+(n-3)h$	0	O_3
	Subcontract	$s+2b$	$s+b$	s	...	$s+(n-3)h$	0	S_3
Demand					...			Total

r = Regular production cost per unit
 f = Overtime cost per unit
 s = Subcontracting cost per unit
 h = Holding cost per unit period
 b = Backorder cost per unit per period
 n = Number of periods in planning horizon

given a unit cost of 0 if it is used to satisfy demand in period 1. However, if it is held over for use in later periods, a holding cost of h per unit is added for each period. If the inventory is to be held for the entire planning horizon, a total unit cost of h times the number of periods, n , will be incurred.

Example 3 illustrates the setup and final solution of a transportation model of an aggregate planning problem.

EXAMPLE 3

eXcel

mhhe.com/stevenson14e

Setting Up and Solving a Transportation Table

Given the following information, set up the problem in a transportation table (see Table 11.6) and solve for the minimum-cost plan.

	PERIOD		
	1	2	3
Demand	550	700	750
Capacity			
Regular	500	500	500
Overtime	50	50	50
Subcontract	120	120	100
Beginning inventory	100		
Costs			
Regular time	\$60 per unit		
Overtime	\$80 per unit		
Subcontract	\$90 per unit		
Inventory carrying cost	\$1 per unit per month		
Backorder cost	\$3 per unit per month		

SOLUTION

The transportation table and solution are shown in Table 11.6. Some of the entries require additional explanation:

- In this example, inventory carrying costs are \$1 per unit per period (costs are shown in the upper right-hand corner of each cell in the table). Hence, units produced in one period and carried over to a later period will incur a holding cost that is a linear function of the length of time held.
- Linear programming models of this type require that supply (capacity) and demand be equal. A dummy column has been added (nonexistent capacity) to satisfy that requirement. Because it does not “cost” anything extra to not use capacity that doesn’t actually exist, cell costs of \$0 have been assigned.
- No backlogs were needed in this example.
- The quantities (e.g., 100 and 450 in column 1) are the amounts of output or inventory that will be used to meet demand requirements. Thus, the demand of 550 units in period 1 will be met using 100 units from inventory and 450 obtained from regular-time output.

Where backlogs are not permitted, the cell costs for the backlog positions can be made prohibitively high so that no backlogs will appear in the solution.

The main limitations of LP models are the assumptions of linear relationships among variables, the inability to continuously adjust output rates, and the need to specify a single objective (e.g., minimize costs) instead of using multiple objectives (e.g., minimize cost while stabilizing the workforce).

Simulation models Computerized models that can be tested under different scenarios to identify acceptable solutions to problems.

Simulation Models. A number of **simulation models** have been developed for aggregate planning. (An introduction to simulation is available on the textbook website.) The essence of simulation is the development of computerized models that can be tested under a variety

Supply from		Demand for				Total capacity available (supply)
		Period 1	Period 2	Period 3	Unused capacity (dummy)	
Period 1	Beginning inventory	0 100	1	2	0	100
	Regular time	60 450	61 50	62	0	500
	Overtime	80	81 50	82	0	50
	Subcontract	90	91 30	92	90	120
Period 2	Regular time	63	60 500	61	0	500
	Overtime	83	80 50	81	0	50
	Subcontract	93	90 20	91 100	0	120
Period 3	Regular time	66	63	60 500	0	500
	Overtime	86	83	80 50	0	50
	Subcontract	96	93	90 100	0	100
Demand		550	700	750	90	2,090

TABLE 11.6
Transportation solution

of conditions in an attempt to identify reasonably acceptable (although not always optimal) solutions to problems.

Table 11.7 summarizes planning techniques.

Aggregate planning techniques other than trial and error do not appear to be widely used. Instead, in the majority of organizations, aggregate planning seems to be accomplished more on the basis of experience along with trial-and-error methods. It is difficult to say exactly why some of the mathematical techniques mentioned are not used to any great extent. Perhaps the level of mathematical sophistication discourages greater use, or the assumptions required in certain models appear unrealistic, or the models may be too narrow in scope. Whatever the reasons, none of the techniques to date have captured the attention of aggregate planners on a broad scale. Simulation is one technique that seems to be gaining favor. Research on improved approaches to aggregate planning is continuing.

Technique	Solution Approach	Characteristics
Spreadsheet	Heuristic (trial and error)	Intuitively appealing, easy to understand; solution not necessarily optimal
Linear programming	Optimizing	Computerized; linear assumptions not always valid
Simulation	Heuristic (trial and error)	Computerized models can be examined under a variety of conditions

TABLE 11.7
Summary of planning techniques

11.4 AGGREGATE PLANNING IN SERVICES

LO11.6 Discuss aggregate planning in services.

Aggregate planning for services takes into account projected customer demands, equipment capacities, and labor capabilities. The resulting plan is a time-phased projection of service staff requirements.

The following are examples of service organizations that use aggregate planning.

Hospitals: Hospitals use aggregate planning to allocate funds, staff, and supplies to meet the demands of patients for their medical services. For example, plans for bed capacity, medications, surgical supplies, and personnel needs are based on patient load forecasts.

Airlines: Aggregate planning in the airline industry is fairly complex due to the need to take into account a wide range of factors (planes, flight personnel, ground personnel) and multiple routes and landing/departure sites. Also, capacity decisions must take into account the percentage of seats to be allocated to various fare classes in order to maximize profit or yield.

Restaurants: Aggregate planning in the case of a high-volume product output business such as a restaurant is directed toward smoothing the service rate, determining the size of the workforce, and managing demand to match a fixed kitchen and eating capacity. The general approach usually involves adjusting the number of staff according to the time of day and the day of the week.

Other services: Financial, hospitality, transportation, and recreation services provide a high-volume, intangible output. Aggregate planning for these and similar services involves managing demand and planning for human resource requirements. The main goals are to accommodate peak demand and to find ways to effectively use labor resources during periods of low demand.

Aggregate planning for manufacturing and aggregate planning for services share similarities in some respects, but there are some important differences—related in general to the differences between manufacturing and services:

1. **Demand for service can be difficult to predict.** The volume of demand for services is often quite variable. In some situations, customers may *need* prompt service (e.g., police, fire, medical emergency), while in others, they simply *want* prompt service and

Lunchtime line of people at Chacarero, a popular fast-food Chilean restaurant at Downtown Crossing, Boston, Massachusetts. Predicting steady demand from nearby office workers makes it much easier to provide staffing and prompt food service.



Chuck Pefley/Alamy Stock Photo

may be willing to go elsewhere if their wants are not met. These factors place a greater burden on service providers to anticipate demand. Consequently, service providers must pay careful attention to planned capacity levels.

2. **Capacity availability can be difficult to predict.** Processing requirements for services can sometimes be quite variable, similar to the variability of work in a job shop setting. Moreover, the variety of tasks required of servers can be great, again similar to the variety of tasks in a job shop. However, in services, the types of variety are more pervasive than they are in manufacturing. This makes it more difficult to establish simple measures of capacity. For example, what would be the capacity of a person who paints interiors of houses? The number of rooms per day or the number of square feet per hour are possible measures, but rooms come in many different sizes, and because the level of detail (and, thus, the painting implements that can be used) vary tremendously, a suitable measure for planning purposes can be quite difficult to arrive at. Similarly, bank tellers are called upon to handle a wide variety of transactions and requests for information, again making it difficult to establish a suitable measure of their capacity.
3. **Labor flexibility can be an advantage in services.** Labor often comprises a significant portion of service compared to manufacturing. That, coupled with the fact that service providers are often able to handle a fairly wide variety of service requirements, means that to some extent, planning is easier than it is in manufacturing. Of course, manufacturers recognize this advantage, and many are cross-training their employees to achieve the same flexibility. Moreover, in both manufacturing and service systems, the use of part-time workers can be an important option (e.g., Uber eats). Note that in self-service systems, the (customer) labor automatically adjusts to changes in demand!
4. **Services occur when they are rendered.** Unlike manufacturing output, most services can't be inventoried. Services such as financial planning, tax counseling, and oil changes can't be stockpiled. This removes the option of building up inventories during a slow period in anticipation of future demand. Moreover, service capacity that goes unused is essentially wasted. Consequently, it becomes even more important to be able to match capacity and demand.

Because service capacity is perishable (e.g., an empty seat on an airplane flight can't be saved for use on another flight), aggregate planners need to take that into account when deciding how to match supply and demand. **Yield management** is an approach that seeks to maximize revenue by using a strategy of variable pricing; prices are set relative to capacity availability. Thus, during periods of low demand, price discounts are offered to attract a wider population. Conversely, during peak periods, higher prices are posted to take advantage of limited supply relative to demand. Uber refers to it as surge pricing. Users of yield management include airlines, restaurants, theaters, hotels, resorts, cruise lines, and parking lots.

Yield management The application of pricing strategies to allocate capacity among various categories of demand.

11.5 DISAGGREGATING THE AGGREGATE PLAN

For the production plan to be translated into meaningful terms for production, it is necessary to *disaggregate* the aggregate plan. This means breaking down the aggregate plan into specific product requirements in order to determine labor requirements (skills, size of workforce), materials, and inventory requirements.

Working with aggregate units facilitates intermediate planning. However, to put the production plan into operation, one must convert, or disaggregate, those aggregate units into units of actual products or services to be produced or offered. For example, an appliance manufacturer might produce refrigerators, freezers, clothes washers, clothes dryers, and dishwashers. The aggregate plans would have to be broken down into quantities of each of these products. Similarly, a lawn mower manufacturer may have an aggregate plan that calls for 200 riding mowers in January, 300 in February, and 400 in March. That company may

LO11.7 Disaggregate an aggregate plan.

Master production schedule (MPS) This schedule indicates the quantity and timing of planned completed production.

FIGURE 11.4
Moving from the aggregate plan to a master schedule

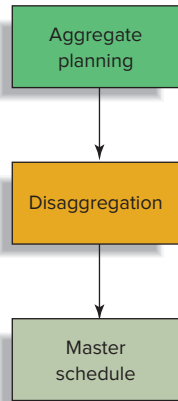

produce three different models of riding mowers. Although all the mowers probably contain some of the same parts and involve some similar or identical operations for fabrication and assembly, there would be some differences in the materials, parts, and operations that each type requires. Hence, the 200, 300, and 400 aggregate lawn mowers to be produced during those three months must be translated into specific numbers of mowers of each model prior to actually purchasing the appropriate materials and parts, scheduling operations, and planning inventory requirements.

The result of disaggregating the aggregate plan is a **master production schedule (MPS)**, or simply master schedule, showing the quantity and timing of *specific* end items for a scheduled horizon, which often covers about six to eight weeks ahead. A master schedule shows the planned output for individual products rather than an entire product group, along with the timing of production. The master schedule contains important information for marketing as well as for production. It reveals when orders are scheduled for production and when completed orders are to be shipped.

Figure 11.4 shows an overview of the context of disaggregation.

Figure 11.5 illustrates disaggregating the aggregate plan. The illustration makes a simple assumption in order to clearly show the concept of disaggregation: The totals of the aggregate and the disaggregated units are equal. In reality, that is not always true. As a consequence, disaggregating the aggregate plan may require considerable effort.

Figure 11.5 shows the aggregate plan broken down by units. However, it also can be useful to show the breakdown in *percentages* for different products or product families.

11.6 MASTER SCHEDULING

The master schedule is the heart of production planning and control. It determines the quantities needed to meet demand from all sources, and governs key decisions and activities throughout the organization.

The master schedule interfaces with marketing, capacity planning, production planning, and distribution planning: It enables marketing to make valid delivery commitments to warehouses and final customers; it enables production to evaluate capacity requirements; it provides the necessary information for production and marketing to negotiate when customer requests cannot be met by normal capacity; and it provides senior management with the opportunity to determine whether the business plan and its strategic objectives will be achieved. The master schedule also drives the material requirements planning (MRP) system that will be discussed in the next chapter.

The capacities used for master scheduling are based on decisions made during aggregate planning. Note that there is a time lapse between the time the aggregate plan is made and the development of a master schedule. Consequently, the outputs shown in a master schedule will not necessarily be identical to those of the aggregate plan, for the simple reason that more up-to-date demand information might be available, which the master schedule would take into account.

The central person in the master scheduling process is the master scheduler.

FIGURE 11.5
Disaggregating the aggregate plan

<i>Aggregate plan</i>	<i>Month Planned output*</i>	<i>Jan.</i>	<i>Feb.</i>	<i>Mar.</i>
		200	300	400

*Aggregate units

<i>Master schedule</i>	<i>Month Planned output*</i>	<i>Jan.</i>	<i>Feb.</i>	<i>Mar.</i>
RMa		100	100	100
RMb		75	150	200
RMc		25	50	100
Total		200	300	400

*Actual units

The Master Scheduler

Most manufacturing organizations have (or should have) a master scheduler. The duties of the master scheduler generally include:

1. Evaluating the impact of new orders
2. Providing delivery dates for orders
3. Dealing with problems:
 - a. Evaluating the impact of production delays or late deliveries of purchased goods
 - b. Revising the master schedule when necessary because of insufficient supplies or capacity
 - c. Bringing instances of insufficient capacity to the attention of production and marketing personnel so they can participate in resolving conflicts

11.7 THE MASTER SCHEDULING PROCESS

A master schedule indicates the quantity and timing (i.e., delivery times) for a product, or a group of products, but it does not show planned *production*. For instance, a master schedule may call for delivery of 50 cases of cranberry-apple juice to be delivered on May 1. But this may not require any production; there may be 200 cases in inventory. Or it may require *some* production: If there were 40 cases in inventory, an additional 10 cases would be needed to achieve the specified delivery amount. Or it may involve production of 50 or more cases: In some instances, it is more economical to produce large amounts rather than small amounts, with the excess temporarily placed in inventory until needed. Thus, the *production lot size* might be 70 cases, so if additional cases were needed (e.g., 50 cases), a run of 70 cases would be made.

The master production schedule is one of the primary outputs of the master scheduling process, as illustrated in Figure 11.6.

Once a *tentative* master schedule has been developed, it must be validated. This is an extremely important step. Validation is referred to as **rough-cut capacity planning (RCCP)**. It involves testing the feasibility of a proposed master schedule relative to available capacities, to assure that no obvious capacity constraints exist. This means checking capacities of production and warehouse facilities, labor, and vendors to ensure no gross deficiencies exist that will render the master schedule unworkable. The master production schedule then serves as the basis for *short-range* planning. It should be noted that, whereas the aggregate plan covers an interval of, say, 12 months, the master schedule covers only a portion of this. In other words, the aggregate plan is disaggregated in stages, or phases, that may cover a few weeks to two or three months. Moreover, the master schedule may be updated monthly, even though it covers two or three months. For instance, the lawn mower master schedule would probably be updated at the end of January to include any revisions in planned output for February and March, as well as new information on planned output for April.

LO11.8 Describe the master scheduling process and explain its importance.

Rough-cut capacity planning (RCCP) Approximate balancing of capacity and demand to test the feasibility of a master schedule.

Time Fences

Changes to a master schedule can be disruptive, particularly changes to the early, or near, portions of the schedule. Typically, the further out in the future a change is, the less the tendency to cause problems.

High-performance organizations have an effective master scheduling process. A key component of effective scheduling is the use of *time fences* to facilitate order promising and the

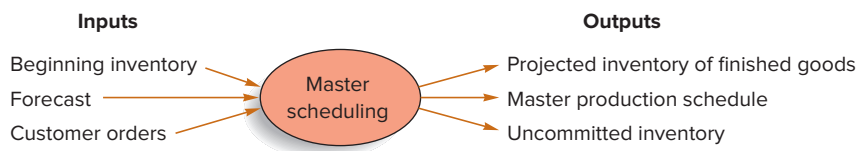
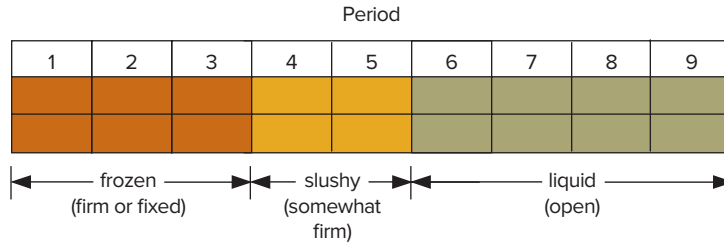

FIGURE 11.6
The master scheduling process

FIGURE 11.7

Time fences in an MPS



Time fences Points in time that separate phases of a master schedule planning horizon.

entry of orders into the system. **Time fences** divide a scheduling time horizon into three sections or phases, sometimes referred to as *frozen*, *slushy*, and *liquid*, in reference to the firmness of the schedule (see Figure 11.7).

Frozen is the near-term phase that is so soon that delivery of a new order would be impossible, or only possible using very costly or extraordinary options such as delaying another order. Authority for new-order entry in this phase usually lies with the VP of manufacturing. The length of the frozen phase is often a function of the total time needed to produce a product, from procuring materials to shipping the order. There is a high degree of confidence in order-promise dates.

Slushy is the next phase, and its time fence is usually a few periods beyond the frozen phase. Order entry in this phase necessitates trade-offs, but is less costly or disruptive than in the frozen phase. Authority for order entry usually lies with the master scheduler. There is relative confidence in order-promise dates, and capacity planning becomes very specific.

Liquid is the farthest out on the time horizon. New orders or cancellations can be entered with ease. Order promise dates are tentative, and will be firmed up with the passage of time when orders are in the firm phase of the schedule horizon.

A key element in the success of the master scheduling process is strict adherence to time fence policies and rules. It is essential that they be adhered to and communicated throughout the organization.

Inputs

The master schedule has three inputs: the beginning inventory, which is the actual quantity on hand from the preceding period; actual forecasts for each period of the schedule; and customer orders, which are quantities already *committed* to customers. Other factors that might need to be taken into consideration include any hiring or firing restrictions imposed by HR, skill levels, limits on inventory such as available space, whether items are perishable, and whether there are some market lifetime (e.g., seasonal or obsolescence) considerations.

Outputs

The master scheduling process uses this information on a period-by-period basis to determine the projected inventory, production requirements, and the resulting uncommitted inventory, which is referred to as **available-to-promise (ATP) inventory**. Knowledge of the uncommitted inventory can enable marketing to make realistic promises to customers about deliveries of new orders.

The master scheduling process begins with a preliminary calculation of projected on-hand inventory. This reveals when additional inventory (i.e., production) will be needed. Consider the following example. A company that makes industrial pumps wants to prepare a master production schedule for June and July. Marketing has forecasted demand of 120 pumps for June and 160 pumps for July. These have been evenly distributed over the four weeks in each month: 30 per week in June and 40 per week in July, as illustrated in Figure 11.8A.

Now, suppose there are currently 64 pumps in inventory (i.e., beginning inventory is 64 pumps), and there are customer orders that have been committed (booked) and must be filled (see Figure 11.8B).

Figure 11.8B contains the three primary inputs to the master scheduling process: the beginning inventory, the forecast, and the customer orders that have been booked or committed. This information is necessary to determine three quantities: the projected on-hand inventory, the master production schedule, and the uncommitted (ATP) inventory. The first

Available-to-promise (ATP) inventory Uncommitted inventory.

	June				July			
	1	2	3	4	5	6	7	8
Forecast	30	30	30	30	40	40	40	40

FIGURE 11.8A
Weekly forecast requirements for industrial pumps

Beginning inventory 64	June				July			
	1	2	3	4	5	6	7	8
Forecast	30	30	30	30	40	40	40	40
Customer orders (committed)	33	20	10	4	2			

FIGURE 11.8B
Eight-week schedule showing forecasts, customer orders, and beginning inventory

step is to calculate the projected on-hand inventory, one week at a time, until it falls below a specified limit. In this example, the specified limit will be zero. Hence, we will continue until the projected on-hand ending inventory becomes negative.

The projected on-hand inventory is calculated as follows:

$$\text{Projected on-hand inventory} = \text{Inventory from previous week} - \text{Current week's requirements} \tag{11-1}$$

where the current week's requirements are the *larger* of forecast and customer orders (committed).

For the first week, projected on-hand inventory equals beginning inventory minus the larger of forecast and customer orders. Because customer orders (33) are larger than the forecast (30), the customer orders amount is used. Thus, for the first week, we obtain

$$\text{Projected on-hand inventory} = 64 - 33 = 31$$

Projected on-hand inventories are shown in Figure 11.9 for the first three weeks (i.e., until the projected on-hand amount becomes negative).

Beginning inventory 64	June				July			
	1	2	3	4	5	6	7	8
Forecast	30	30	30	30	40	40	40	40
Customer orders (committed)	33	20	10	4	2			
Projected on-hand inventory	31	1	-29					

FIGURE 11.9
Projected on-hand inventory is computed week by week until it becomes negative

Customer orders are larger than forecast in week 1; projected on-hand inventory is $64 - 33 = 31$

Forecast is larger than customer orders in week 2; projected on-hand inventory is $31 - 30 = 1$

Forecast is larger than customer orders in week 3; projected on-hand inventory is $1 - 30 = -29$

	June				July			
	1	2	3	4	5	6	7	8
Forecast	30	30	30	30	40	40	40	40
Customer orders (committed)	33	20	10	4	2			
Projected on-hand inventory	31	1	41	11	41	1	31	61
MPS			70		70		70	70
Available-to-promise inventory (uncommitted)	11		56		68		70	70

FIGURE 11.12

The available-to-promise inventory quantities have been added to the master schedule

first week and for other weeks in which there is an MPS quantity. Hence, it is calculated for weeks 1, 3, 5, 7, 8.) See Figure 11.12.

For weeks other than the first week, the beginning inventory drops out of the computation, and ATP is the look-ahead quantity subtracted from the MPS quantity.

Thus, for week 3, the promised amounts are $10 + 4 = 14$, and the ATP is $70 - 14 = 56$.

For week 5, customer orders are 2 (future orders have not yet been booked). The ATP is $70 - 2 = 68$.

For weeks 7 and 8, there are no customer orders, so for the present, all of the MPS amount is available to promise.

As additional orders are booked, these would be entered in the schedule, and the ATP amounts would be updated to reflect those orders. Marketing can use the ATP amounts to provide realistic delivery dates to customers.

Aggregate planning establishes general levels of employment, output, and inventories for periods of 2 to 12 months. In the spectrum of planning, it falls between the broad decisions of long-range planning and the very specific and detailed short-range planning decisions. It begins with an overall forecast for the planning horizon and ends with preparations for applying the plans to specific products and services.

The essence of aggregate planning is the aggregation of products or services into one “product” or “service.” This permits planners to consider overall levels of employment and inventories without having to become involved with specific details that are better left to short-range planning. Planners often use informal graphic and charting techniques to develop plans, although various mathematical techniques have been suggested. It appears that the complexity and the restrictive assumptions of these techniques limit their widespread use in practice.

After the aggregate plan has been developed, it is disaggregated or broken down into specific product requirements. This leads to a master schedule, which indicates the planned quantities and timing of specific outputs. Inputs to the master schedule are on-hand inventory amounts, forecasts of demand, and customer orders. The outputs are projected production and inventory requirements, and the projected uncommitted inventory, which is referred to as available-to-promise (ATP) inventory.

1. An aggregate plan is an intermediate-range plan for a collection of similar products or services that sets the stage for shorter-range plans. See Table 11.8 for a convenient summary of aggregate planning.
2. Master scheduling breaks an aggregate plan into specific shorter-range output quantity and timing requirements.
 - a. Rough-cut capacity planning tests the feasibility of a tentative master plan in terms of capacity.

SUMMARY

KEY POINTS

TABLE 11.8

Summary of aggregate planning

Purpose

Decide on the combination of
 Output rates
 Employment levels
 On-hand inventory levels

Objectives

Minimize cost
 Others, may include
 Maintain a desirable level of customer service
 Minimize workforce fluctuations

Possible Strategies**A. Supply Management (reactive)****Level Production**

Allow inventory to absorb variations in demand
 Use back ordering during periods of high demand

Chase Production

Vary output by varying the number of workers by hiring or layoffs to track demand
 Vary output throughout the use of overtime or idle time
 Vary output using part-time workers
 Use subcontracting to supplement output

Mixed Strategy

Use a combination of level and chase approaches

B. Demand Management (proactive)

Influence demand through promotion, pricing, etc.
 Produce goods or services that have complementary demand patterns

Managerial Importance of Aggregate Planning

Has an effect on
 Costs
 Equipment utilization
 Customer satisfaction
 Employment levels
 Synchronization of flow throughout the supply chain

- b. Time fences describe the various time periods in terms of the degree to which the master schedule is firm or flexible. Early periods do not generally allow changes, while later periods have more flexibility.
3. It is essential to include the entire supply chain when developing the aggregate plan.

KEY TERMS

aggregate planning, 465	level capacity strategy, 474	sales and operations
available-to-promise (ATP)	master production schedule	planning, 466
inventory, 488	(MPS), 486	simulation models, 482
chase demand	rough-cut capacity planning	time fences, 488
strategy, 474	(RCCP), 487	yield management, 485

SOLVED PROBLEMS

A manager is attempting to put together an aggregate plan for the coming nine months. She has obtained a forecast of expected demand for the planning horizon. The plan must deal with highly seasonal demand; demand is relatively high in periods 3 and 4, and again in period 8, as can be seen from the following forecasts.

Period	1	2	3	4	5	6	7	8	9	Total
Forecast	190	230	260	280	210	170	160	260	180	1,940

The department now has 20 full-time employees, each of whom produces 10 units of output per period at a cost of \$6 per unit. Beginning inventory for period 1 is zero. Inventory carrying cost is \$5 per unit per period, and backlog cost is \$10 per unit per period.

- Will the current workforce be able to handle the forecast demand?
- Determine the total cost of the plan, including production, inventory, and backorder costs.

- With the current workforce of 20 people, each producing 10 units per period, regular capacity is 1,800 units for the nine-month period. That is 140 units less than expected demand. So there will be a backlog of unfilled demand if actual demand equals the forecast.
- The production plan is:

Period	1	2	3	4	5	6	7	8	9	Total
Forecast	190	230	260	280	210	170	160	260	180	1,940
Output										
Regular	200	200	200	200	200	200	200	200	200	1,800
Overtime	—	—	—	—	—	—	—	—	—	—
Subcontract	—	—	—	—	—	—	—	—	—	—
Output — Forecast	10	(30)	(60)	(80)	(10)	30	40	(60)	20	(140)
Inventory										
Beginning	0	10	0	0	0	0	0	20	0	
Ending	10	0	0	0	0	0	20	0	0	
Average	5	5	10	0	0	0	10	10	0	10
Backlog	0	20	80	160	170	140	100	160	140	970
Costs										
Output										
Regular @ \$6	1,200	1,200	1,200	1,200	1,200	1,200	1,200	1,200	1,200	\$10,800
Overtime										
Subcontract										
Inventory @ \$5	\$ 25	\$ 25	0	0	0	0	0	0	0	\$ 50
Back order @ \$10	0	\$ 200	800	1,600	1,700	1,400	1,000	1,600	1,400	\$ 9,700
Total	\$ 1,225	1,425	2,000	2,800	2,900	2,600	2,200	2,800	2,600	\$20,550

The total cost for this plan is \$20,550. This plan may or may not be good. The manager would need information on other costs and options before settling on one plan.

Problem 1

Solution

Although the calculations are relatively straightforward, the backlogs can sometimes seem difficult to obtain. Consider these rules for computing the backlog:

1. Start with the Output–Forecast value. If this is positive and there was a backlog in the preceding period, reduce the backlog by this amount. If the amount exceeds the backlog, the difference becomes the ending inventory for the period. If they are exactly equal, the backlog and the ending inventory will both be equal to zero.
2. If Output–Forecast is negative, subtract it from the beginning inventory. If this produces a negative value, that value becomes the backlog for that period.

You also can use the Excel template Aggregate Planning (B) to obtain the solution:

Period	1	2	3	4	5	6	7	8	9	Total
Forecast	190	230	260	280	210	170	160	260	180	1,940
Output										
Regular Part	200	200	200	200	200	200	200	200	200	1,800
Time										0
Overtime										0
Subcontract										0
Output–Forecast	10	–30	–60	–80	–10	30	40	–60	20	–140
Inventory										
Beginning	0	10	0	0	0	0	0	0	0	10
Ending	10	0	0	0	0	0	0	0	0	
Average	5	5	0	0	0	0	0.0	0.0	0.0	
Backlog	0	20	80	160	170	140	100	160	140	970
Costs										
Regular @ 6	\$1,200	\$1,200	\$1,200	\$1,200	\$1,200	\$1,200	\$1,200	\$1,200	\$1,200	\$10,800
Part Time @	\$ 0	\$ 0	\$ 0	\$ 0	\$ 0	\$ 0	\$ 0	\$ 0	\$ 0	\$ 0
Overtime @	\$ 0	\$ 0	\$ 0	\$ 0	\$ 0	\$ 0	\$ 0	\$ 0	\$ 0	\$ 0
Subcontract @	\$ 0	\$ 0	\$ 0	\$ 0	\$ 0	\$ 0	\$ 0	\$ 0	\$ 0	\$ 0
Hire/Layoff										\$ 0
Inventory @ 5	\$ 25	\$ 25	\$ 0	\$ 0	\$ 0	\$ 0	\$ 0	\$ 0	\$ 0	\$ 50
Back orders @ 10	\$ 0	\$ 200	\$ 800	\$1,600	\$1,700	\$1,400	\$1,000	\$1,600	\$1,400	\$ 9,700
Total	\$1,225	\$1,425	\$2,000	\$2,800	\$2,900	\$2,600	\$2,200	\$2,800	\$2,600	\$20,550

Problem 2 Spring and Summer Fashions, a clothing producer, has generated a forecast for the next eight weeks. Demand is expected to be fairly steady, except for periods 3 and 4, which have higher demands.

Period	1	2	3	4	5	6	7	8	Total
Forecast	1,200	1,200	1,400	3,000	1,200	1,200	1,200	1,200	11,600

The company typically hires seasonal workers to handle the extra workload in periods 3 and 4. The cost for hiring and training a seasonal worker is \$50 per worker, and the company plans to hire two additional workers and train them in period 3, for work in period 4, and then lay them off (no cost for layoff). Develop an aggregate plan that uses steady output from regular workers with added output from the two seasonal workers in period 4. The output rate for the seasonal workers is slightly less than that of regular workers, so their cost per unit is higher. The cost per unit for regular workers is \$4 per unit, while cost per unit for the seasonal workers is \$5 per unit. Backlog cost is \$1 per unit per period.

Solution

Period			1	2	3	4	5	6	7	8	Total
Forecast			1,200	1,200	1,400	3,000	1,200	1,200	1,200	1,200	11,600
Output											
Regular			1,200	1,200	1,200	1,200	1,200	1,200	1,200	1,200	9,600
Part Time						2,000					2,000
Overtime											0
Subcontract											0
Output – Forecast			0	0	-200	200	0	0	0	0	0
Inventory											
Beginning			0	0	0	0	0	0	0	0	
Ending			0	0	0	0	0	0	0	0	
Average			0.0	0.0	0.0	0.0	0.0	0.0	0.0	0.0	0
Backlog			0	0	200	0	0	0	0	0	200
Costs :											
Regular	@	4	4,800	4,800	4,800	4,800	4,800	4,800	4,800	4,800	38,400
Part Time	@	5	0	0	0	10,000	0	0	0	0	10,000
OverTime	@		0	0	0	0	0	0	0	0	0
Subcontract	@		0	0	0	0	0	0	0	0	0
Hire/Layoff		50			100						100
Inventory	@		0.0	0.0	0.0	0.0	0.0	0.0	0.0	0.0	0.0
Back orders	@	1	0	0	200	0	0	0	0	0	200
Total			4,800	4,800	5,100	14,800	4,800	4,800	4,800	4,800	48,700

Prepare a schedule like that shown in Figure 11.12 for the following situation: The forecast for each period is 70 units. The starting inventory is zero. The MPS rule is to schedule production if the projected inventory on hand is negative. The production lot size is 100 units. The following table shows committed orders.

Problem 3

Period	Customer Orders
1	80
2	50
3	30
4	10

Solution

Period	(A) Projected Inventory from Previous Period	(B) Requirements*	(C = A – B) Net Inventory Before MPS	MPS	(MPS + C) Projected On-Hand Inventory
1	0	80	(80)	100	20
2	20	70	(50)	100	50
3	50	70	(20)	100	80
4	80	70	10	0	10

*Requirements equal the larger of forecast and customer orders in each period.

Starting Inv. = 0	1	2	3	4
Forecast	70	70	70	70
Customer orders	80	50	30	10
Projected on-hand inventory	20	50	80	10
MPS	100	100	100	0
ATP	20	50	60	0

You could also obtain the same solution using the Excel template for master scheduling.

Week	0	1	2	3	4	5	6	7	8
Forecast		70	70	70	70				
Customer orders (committed)		80	50	30	10				
Projected on-hand inventory		20	50	80	10	10	10	10	10
MPS		100	100	100					
ATP		20	50	60					

DISCUSSION AND REVIEW QUESTIONS

1. What three levels of planning involve operations managers? What kinds of decisions are made at the various levels?
2. What are the three phases of intermediate planning?
3. What is aggregate planning? What is its purpose?
4. Why is there a need for aggregate planning?
5. What are the most common decision variables for aggregate planning in a manufacturing setting? In a service setting?
6. What aggregate planning difficulty that might confront an organization offering a variety of products and/or services would not confront an organization that offers one or a few similar products or services?
7. Briefly discuss the advantages and disadvantages of each of these planning strategies:
 - a. Maintain a level rate of output and let inventories absorb fluctuations in demand.
 - b. Vary the size of the workforce to correspond to predicted changes in demand requirements.
 - c. Maintain a constant workforce size, but vary hours worked to correspond to predicted demand requirements.
8. What are the primary advantages and limitations of informal graphic and charting techniques for aggregate planning?
9. Briefly describe the following planning techniques and give an advantage and disadvantage for each.
 - a. Spreadsheet
 - b. Linear programming
 - c. Simulation
10. What are the inputs to master scheduling? What are the outputs?
11. Explain the managerial significance of aggregate planning.

TAKING STOCK

1. What general trade-offs are involved in master scheduling in terms of the frozen portion of the schedule?
2. Who needs to interface with the master schedule and why?
3. How has technology had an impact on master scheduling?

CRITICAL THINKING EXERCISES

1. Service operations often face more difficulty in planning than their manufacturing counterparts. However, service does have certain advantages that manufacturing often does not. Explain service planning difficulty, and its advantages and disadvantages.
2. Name several behaviors related to aggregate planning or master scheduling that you believe would be unethical, and the ethical principle that would be violated for each.

PROBLEMS

1. Compute the total cost for each aggregate plan using these unit costs:

Regular output = \$40

Overtime = \$50

Subcontract = \$60

Average Balance Inventory = \$10

a. Month	Jan	Feb	Mar	Apr	May	Jun
Forecast Output	300	320	320	340	320	320
Regular	300	300	300	300	300	300
Overtime	20	20	20	20	20	20
Subcontract	0	0	0	0	0	0
Output—Forecast						
Inventory						
Beginning						
Ending						
Average						

b. Month	Jul	Aug	Sep	Oct	Nov	Dec
Forecast	320	340	360	380	400	400
Output						
Regular	300	300	300	300	300	300
Overtime	20	20	20	20	30	30
Subcontract	20	30	40	40	60	70
Output—Forecast						
Inventory						
Beginning						
Ending						
Average						

c. (Refer to part *b*) After complaints from some workers about working overtime every month during the first half of the year, the manager is now considering adding some temporary workers for the second half of the year, which would increase regular output to a steady 350 units a month, not using any overtime, and using subcontracting to make up needed output. Determine the total cost of that plan.

2. A manager would like to know the total cost of a chase strategy that matches the forecast below using a steady regular production rate of 200 units a month, a maximum of 20 units per month of overtime, and subcontracting as needed to make up any shortages. The unit costs are:

- Regular production = \$35
- Overtime = \$70
- Subcontracting = \$80

Month	1	2	3	4	5	6
Forecast	230	200	240	240	250	240

3. Determine the total cost for this plan given the following forecast:

Month	1	2	3	4	5	6
Forecast	380	400	420	440	460	480

Use steady regular output of 400 units per month, use overtime as needed for up to 40 units per month, and use subcontracting to make up any needed output to match the forecast. Unit costs are:

- Regular output = \$25
- Overtime = \$40
- Subcontract = \$60
- Average Balance Inventory = \$15

4. a. Given the following forecast and steady regular output of 550 every month, what total cost would result if overtime is limited to a maximum of 40 units a month, and subcontracting is limited to a maximum of 10 units a month? Unit costs are:

- Regular output = \$20
- Overtime = \$30
- Subcontract = \$25
- Average Inventory = \$10
- Backlog = \$18

Month	1	2	3	4	5	6
Forecast	540	540	570	590	600	580

b. Suppose now that backlogs are not allowed. Modify your plan from part *a* to accommodate that new condition as economically as possible. The limits on overtime and subcontracting remain the same.

5. Manager T. C. Downs of Plum Engines, a producer of lawn mowers and leaf blowers, must develop an aggregate plan given the forecast for engine demand shown in the table. The department has a regular output capacity of 130 engines per month. Regular output has a cost of \$60 per engine. The beginning inventory is zero engines. Overtime has a cost of \$90 per engine.

a. Develop a chase plan that matches the forecast and compute the total cost of your plan. Regular production can be less than regular capacity.

- b. Compare the costs to a level plan that uses inventory to absorb fluctuations. Inventory carrying cost is \$2 per engine per month. Backlog cost is \$90 per engine per month. There should not be a backlog in the last month. Assume that using overtime is not an option.

	MONTH								Total
	1	2	3	4	5	6	7	8	
Forecast	120	135	140	120	125	125	140	135	1,040

- 6. Manager Chris Channing of Fabric Mills, Inc., has developed the forecast shown in the table for bolts of cloth. The figures are in hundreds of bolts. The department has a regular output capacity of 275(00) bolts per month, except for the seventh month, when capacity will be 250(00) bolts. Regular output has a cost of \$40 per hundred bolts. Workers can be assigned to other jobs if production is less than regular. The beginning inventory is zero bolts.

- a. Develop a chase plan that matches the forecast and compute the total cost of your plan. Overtime is \$60 per hundred bolts. Regular production can be less than regular capacity.
- b. Would the total cost be less with regular production with no overtime, but using a subcontractor to handle the excess above regular capacity at a cost of \$50 per hundred bolts? Backlogs are not allowed. The inventory carrying cost is \$2 per hundred bolts.

Month	1	2	3	4	5	6	7	Total
Forecast	250	300	250	300	280	275	270	1,925

- 7. SummerFun, Inc., produces a variety of recreation and leisure products. The production manager has developed an aggregate forecast:

Month	Mar	Apr	May	Jun	Jul	Aug	Sep	Total
Forecast	50	44	55	60	50	40	51	350

Use the following information to develop aggregate plans.

Regular production cost	\$80 per unit	Backorder cost	\$20 per unit
Overtime production cost	\$120 per unit	Beginning inventory	0 units
Regular capacity	40 units per month		
Overtime capacity	8 units per month		
Subcontracting cost	\$140 per unit		
Subcontracting capacity	12 units per month		
Holding cost	\$10 per unit per month		

Develop an aggregate plan using each of the following guidelines and compute the total cost for each plan. *Hint:* You will need extra output in April and August to accommodate demand in the following months.

- a. Use regular production. Supplement using inventory, overtime, and subcontracting as needed. No backlogs allowed.
 - b. Use a level strategy. Use a combination of backlogs, subcontracting, and inventory to handle variations in demand. There should not be a backlog in the final period.
- 8. Nowjuice, Inc., produces Shakewell® fruit juice. A planner has developed an aggregate forecast for demand (in cases) for the next six months.

Month	May	Jun	Jul	Aug	Sep	Oct
Forecast	4,000	4,800	5,600	7,200	6,400	5,000

Use the following information to develop aggregate plans.

Regular production cost	\$10 per case
Regular production capacity	5,000 cases
Overtime production cost	\$16 per case
Subcontracting cost	\$20 per case
Holding cost	\$1 per case per month
Beginning inventory	0

Develop an aggregate plan using each of the following guidelines and compute the total cost for each plan. Which plan has the lowest total cost? *Note:* Backlogs are not allowed.

- a. Use level production. Supplement using overtime as needed.
 - b. Use a combination of overtime (500 cases per period maximum), inventory, and subcontracting (500 cases per period maximum) to handle variations in demand.
 - c. Use overtime up to 750 cases per period and inventory to handle variations in demand.
9. Wormwood, Ltd., produces a variety of furniture products. The planning committee wants to prepare an aggregate plan for the next six months using the following information.

	Month						Cost Per Unit	
	1	2	3	4	5	6		
Demand	160	150	160	180	170	140	Regular time	\$50
Capacity							Overtime	75
Regular	150	150	150	150	160	160	Subcontract	80
Overtime	10	10	0	10	10	10	Inventory holding, per month	4

Subcontracting can handle a maximum of 10 units per month. Beginning inventory is zero.

Develop a plan that minimizes total cost. No back orders are allowed. Regular capacity = Regular production.

10. Refer to Solved Problem 1. Prepare two additional aggregate plans. Call the one in the solved problem plan A. For plan B, hire one more worker at a cost of \$200. Make up any shortfall using subcontracting at \$8 per unit, with a maximum of 20 units per period (i.e., use subcontracting to reduce back orders when the forecast exceeds regular output). Note that the ending inventory in period 9 should be zero. Therefore, Total forecast – Total output = Quantity subcontracted. An additional constraint is that back orders cannot exceed 80 units in any period. For plan C, assume no workers are hired (so regular output is 200 units per period instead of 210 as in plan B). Use subcontracting as needed, but no more than 20 units per period. Compute the total cost of each plan. Which plan has the lowest cost? Assume regular monthly production = regular capacity.
11. Refer to Solved Problem 1. Suppose another option is to use part-time workers to assist during seasonal peaks. The cost per unit, including hiring and training, is \$11. The output rate is 10 units per worker per period for all workers. A maximum of 10 part-time workers can be used, and the same number of part-time workers must be used in all periods that have part-time workers. The ending inventory in period 9 should be 10 units. The limit on backlogs is 20 units per period. Try to make up backlogs as soon as possible. Compute the total cost for this plan, and compare it to the cost of the plan used in the solved problem. Assume 20 full-time workers and regular monthly production = regular capacity.
12. Refer to Solved Problem 1. Prepare an aggregate plan that uses overtime (\$9 per unit, maximum output 25 units per period) and inventory variation. Try to minimize backlogs. The ending inventory in period 9 should be zero, and the limit on backlogs is 60 units per period. Compute the total cost of your plan, and compare it to the total cost of the plan used in the solved problem. Assume 20 full-time workers.
13. Refer to Example 2. Determine if a plan to use subcontracting at a maximum rate of 50 units per period as needed with no overtime would achieve a lower total cost than the plan shown in Example 2. Again, plan for a zero inventory balance at the end of period 6. Regular production can be less than regular capacity.
14. Verify the transportation solution shown in Example 3.
15. Refer to Example 3. Suppose that an increase in warehousing costs and other costs brings inventory carrying costs to \$2 per unit per month. All other costs and quantities remain the same. Determine a revised solution to this transportation problem. Solve by modifying Table 11.6.
16. Refer to Example 3. Suppose that regular-time capacity will be reduced to 440 units in period 3 to accommodate a companywide safety inspection of equipment. What will the additional cost of the optimal plan be as compared to the one shown in Example 3? Assume all costs and quantities are the same as given in Example 3 except for the regular-time output in period 3. Solve by modifying Table 11.6.
17. Solve Problem 16 using an inventory carrying cost of \$2 per unit per period.

18. Dundas Bike Components Inc. of Wheelville, Illinois, manufactures bicycle wheels in two different sizes for the Big Bike Co. assembly plant located across town. David Dundas, the firm's owner-manager, has just received Big Bike's order for the next six months.

	Nov	Dec	Jan	Feb	Mar	Apr
20-Inch Wheels	1,000 units	900	600	700	1,100	1,100
24-Inch Wheels	500 units	500	300	500	400	600

- Under what circumstances will it be possible to develop just one aggregate plan rather than two (one for each size wheel)? Explain in two to three sentences without calculations.
 - Currently, Dundas employs 28 full-time employees, each of whom can produce 50 wheels per month in addition to their other tasks. Because labor is in short supply in the Wheelville area, David would like to develop one pure level-output plan. There is no inventory of finished wheels on hand at present, but David would like to have 300 on hand at the end of April. Big Bike will tolerate back orders of up to 200 units per month. Show your level plan in tabular form. The amount produced using overtime should be the same except for the last month.
 - Calculate the total annual cost of your plan using these costs:

Regular	\$50	Hiring	\$300
Overtime	\$75	Layoff	\$400
Part-time	NA	Inventory	\$1.00
Subcontract	NA	Back order	\$6.00
19. Prepare a master production schedule for industrial pumps in the manner of Figure 11.11 in the chapter. Use the same inputs as the example, and lot sizes of 70, but change the MPS rule from "schedule production when the projected on-hand inventory would be negative without production" to "schedule production when the projected on-hand inventory would be less than 10 without production."
20. Update the master schedule shown in Figure 11.11 given these updated inputs: It is now the end of week 1; customer orders are 25 for week 2, 16 for week 3, 11 for week 4, 8 for week 5, and 3 for week 6. Use the MPS rule of ordering production when projected on-hand inventory would be negative without production. Prepare the master schedule for weeks 2 through 8.
21. Prepare a master schedule like that shown in Figure 11.11 given this information: The forecast for each week of an eight-week schedule is 50 units. The MPS rule is to schedule production if the projected on-hand inventory would be negative without it. Customer orders (committed) are as follows.

Week	Customer Orders
1	52
2	35
3	20
4	12

Use a production lot size of 75 units and no beginning inventory.

22. Determine the available-to-promise (ATP) quantities for each period for Problem 21.
23. Prepare a schedule like that shown in Figure 11.12 for the following situation: The forecast is 80 units for each of the first two periods and 60 units for each of the next three periods. The starting inventory is 20 units. The company uses a chase strategy for determining the production lot size, except there is an upper limit on the lot size of 70 units. Also, the desired safety stock is 10 units.

Note: The ATP quantities are based on maximum allowable production.

Note: A negative projected on-hand can occur.

Committed orders are as follows.

Period	Customer Orders
1	82
2	80
3	60
4	40
5	20



EIGHT GLASSES A DAY (EGAD)

The EGAD Bottling Company has decided to introduce a new line of premium bottled water that will include several “designer” flavors. Marketing manager Georgianna Mercer is predicting an upturn in demand based on the new offerings and the increased public awareness of the health benefits of drinking more water. She has prepared aggregate forecasts for the next six months, as shown in the following table (quantities are in tankloads).

Month	May	Jun	Jul	Aug	Sept	Oct	Total
Forecast	50	60	70	90	80	70	420

Production manager Mark Mercer (no relation to Georgianna) has developed the following information. (Costs are in thousands of dollars.)

Regular production cost	\$1 per tankload
Regular production capacity	60 tankloads
Overtime production cost	\$1.6 per tankload
Subcontracting cost	\$1.8 per tankload
Holding cost	\$2 per tankload per month

Backordering cost

Backlogs are not allowed

Beginning inventory

0 tankloads

Among the strategies being considered are the following:

- Level production supplemented by up to 10 tankloads a month from overtime.
- A combination of overtime, inventory, and subcontracting. Regular production should be the same each month.
- Using overtime for up to 15 tankloads a month, along with inventory to handle variations. Regular production should be the same each month.

Question

1. The objective is to choose the plan that has the lowest cost. Which plan would you recommend?
2. Presumably, information about the new line has been shared with supply chain partners. Explain what information should be shared with various partners, and why sharing that information is important.

Burrows, Robert P., Lora Cecere, and Gregory P. Hackett. *The Market-Driven Supply Chain: A Revolutionary Model for Sales and Operations Planning in the New On-Demand Economy*. Miami, FL: The Hackett Group, 2012.

Jacobs, F. Robert, William L. Berry, D. Clay Whybark, and Thomas Vollman. *Manufacturing Planning and Control for Supply Chain Management*;

The CPIM Reference, 2nd ed. New York: McGraw-Hill, 2018.

Wallace, Thomas F., and Robert A. Stahl. *Sales and Operations Planning: The How-to Handbook*, 3rd ed. T. F. Wallace and Company, 2008.

Wallace, Thomas F., and Robert A. Stahl. *Sales and Operations Planning: The Executive's Guide*. T. F. Wallace and Company, 2014.

**SELECTED
BIBLIOGRAPHY AND
FURTHER READINGS**

12

CHAPTER

Inventory Management

LEARNING OBJECTIVES

After completing this chapter, you should be able to:

- LO12.1** Define the term *inventory*.
- LO12.2** List the different types of inventory.
- LO12.3** Describe the main functions of inventories.
- LO12.4** Discuss the main requirements for effective management.
- LO12.5** Explain periodic and perpetual review systems.
- LO12.6** Describe the costs that are relevant for inventory management.
- LO12.7** Describe the A-B-C approach and explain how it is useful.
- LO12.8** Describe the basic EOQ model and its assumptions and solve typical problems.
- LO12.9** Describe the economic production quantity model and solve typical problems.
- LO12.10** Describe the quantity discount model and solve typical problems.
- LO12.11** Describe reorder point models and solve typical problems.
- LO12.12** Describe situations in which the fixed-order-interval model is appropriate, and solve typical problems.
- LO12.13** Describe situations in which the single-period model is appropriate and solve typical problems.

CHAPTER OUTLINE

- 12.1 Introduction** 503
- 12.2 The Nature and Importance of Inventories** 504
 - Functions of Inventory 505
 - Objective of Inventory Management 506
- 12.3 Requirements for Effective Inventory Management** 507
 - Inventory Counting Systems 507
 - Demand Forecasts and Lead-Time Information 509
 - Inventory Costs 509
 - Classification System 510
- 12.4 Inventory Ordering Policies** 513
- 12.5 How Much to Order: Economic Order Quantity Models** 514
 - Basic Economic Order Quantity (EOQ) Model 514
 - Economic Production Quantity (EPQ) 518
 - Quantity Discounts 520
- 12.6 Reorder Point Ordering** 525
- 12.7 How Much to Order: Fixed-Order-Interval Model** 530
 - Reasons for Using the Fixed-Order-Interval Model 530
 - Determining the Amount to Order 530
 - Benefits and Disadvantages 533
- 12.8 The Single-Period Model** 533
 - Continuous Stocking Levels 534
 - Discrete Stocking Levels 535
- 12.9 Operations Strategy** 538
 - Cases:** UPD Manufacturing 553
 - Grill Rite 554
 - Farmers Restaurant 554
 - Operations Tours:** Bruegger's Bagel Bakery 556
 - PSC, Inc. 557



Kris Tripplaar/Sipa USA/Newscom

Inventory management is a core operations management activity. Effective inventory management is important for the successful operation of most businesses and their supply chains, and impacts operations, marketing, and finance. Poor inventory management, however, hampers operations, diminishes customer satisfaction, and increases operating costs.

Some organizations have excellent inventory management, and many have satisfactory inventory management. Too many, however, have unsatisfactory inventory management. They either have too little or too much inventory, inaccurate inventory tracking, or incorrect priorities. What is lacking is an understanding of what needs to be done and how to do it. This chapter presents the concepts and knowledge base for effective inventory management.

12.1 INTRODUCTION

An **inventory** is a stock or store of goods. Firms typically stock hundreds or even thousands of items in inventory, ranging from small things such as pencils, paper clips, screws, nuts, and bolts to large items such as machines, trucks, construction equipment, and airplanes. Naturally, many of the items a firm carries in inventory relate to the kind of business it engages in. Thus, manufacturing firms carry supplies of raw materials, purchased parts, partially finished items, and finished goods, as well as spare parts for machines, tools, and other supplies. Department stores carry clothing, furniture, carpeting, stationery, cosmetics, gifts, cards, and toys. Some also stock sporting goods, paints, and tools. Hospitals stock drugs, surgical supplies, life-monitoring equipment, sheets and pillow cases, and more. Supermarkets stock fresh and canned foods, packaged and frozen foods, household supplies, magazines, baked goods, dairy products, produce, and other items.

Inventory A stock or store of goods.

LO12.1 Define the term *inventory*.



A local factory was having difficulties with managing its inventory, so they asked Bill, a consultant, for his help. Here is what he found: In a recent round of layoffs, a number of older supervisors who had managed ordering had been let go. A newly hired production manager decided to allow newly hired supervisors more freedom in how ordering was accomplished. The new hires eschewed the inventory models that had been used, referring to them as “old school” because they didn’t allow for “intuitive input” from supervisors. As Bill toured the facility, in some areas he found excessive inventories of parts and raw materials (costing \$\$\$), while in others, he heard complaints about shortages

that were severely hampering operations (costing more \$\$\$). When he presented his findings to the production manager and revealed how much the “intuitive approach” was costing the company, the astounded production manager immediately scrapped the “intuitive approach” and replaced it with more appropriate “real world” models. The new supervisors were treated to educational sessions that helped them understand how to use the inventory ordering models. Before long, the problems of inventory excesses and shortages were a thing of the past. Costs decreased substantially, and profits, customer satisfaction, and employee morale all increased.

The inventory models described in this chapter relate primarily to what are referred to as *independent-demand* items—that is, items that are ready to be sold or used. Thus, a computer would be an independent-demand item, whereas the components used to assemble a computer would be dependent-demand items.

12.2 THE NATURE AND IMPORTANCE OF INVENTORIES

LO12.2 List the different types of inventory.

Inventories are a vital part of business. Not only are they necessary for operations, but they also contribute to customer satisfaction. To get a sense of the significance of inventories, consider the following: Some very large firms have tremendous amounts of inventory. For example, General Motors was at one point reported to have as much as \$40 billion worth of materials, parts, and components such as engines in its supply chain! Although the amounts and dollar values of inventories carried by different types of firms vary widely, a typical firm probably has about 30 percent of its current assets and perhaps as much as 90 percent of its working capital invested in inventory. One widely used measure of managerial performance relates to *return on investment (ROI)*, which is profit after taxes divided by total assets. Because inventories may represent a significant portion of total assets, a reduction of inventories can result in a significant increase in ROI, although that benefit has to be weighed against a possible risk of a decrease in customer service. It is interesting to note that the ratio of inventories to sales in the manufacturing, wholesale, and retail sectors is one measure that is used to gauge the health of the U.S. economy.

Inventory decisions in service organizations can range from annoying to critical. Hospitals, for example, carry an array of drugs and blood supplies that might be needed on short notice. Being out of stock on some of these could imperil the well-being of a patient. However, many of these items have a limited shelf life, so carrying large quantities would mean having to dispose of unused, costly supplies. On-site repair services for computers, printers, copiers, and fax machines also have to carefully consider which parts to bring to the site to avoid having to make an extra trip to obtain parts. The same goes for home repair services such as electricians, appliance repairers, and plumbers.

The major source of revenues for retail and wholesale businesses is the sale of merchandise (i.e., inventory). In fact, in terms of dollars, the inventory of goods held for sale is one of the largest assets of a merchandising business. Retail stores that sell clothing wrestle with decisions about which styles to carry, and how much of each to carry, knowing full well that fast-selling items will mean greater profits than having to heavily discount goods that didn’t sell.



stevecoleimages/Getty Images

By initiating a program that utilizes bar codes or RFID tags and scanners, hospitals can control inventory supply areas, as well as keep track of all equipment in use across the enterprise. Stockroom inventory applications track consumable items such as medication and supplies, while check in/out applications track shared or reusable items such as X-rays, lab results, diagnostic tools, and other medical equipment.

Types of inventories include the following:

- Raw materials and purchased parts
- Partially completed goods, called *work-in-process (WIP)*
- Finished-goods inventories (manufacturing firms) or merchandise (retail stores)
- Tools and supplies
- Maintenance and repairs (MRO) inventory
- Goods-in-transit to warehouses, distributors, or customers (pipeline inventory)

Both manufacturing and service organizations have to take into consideration the space requirements of inventory. In some cases, space limitations may pose restrictions on inventory storage capability, thereby adding another dimension to inventory decisions.

To understand why firms have inventories at all, you need to be aware of the various functions of inventory.

Functions of Inventory

Inventories serve a number of functions. Among the most important are the following.

- **To meet anticipated customer demand.** A customer can be a person who walks in off the street to buy a new smartphone, a mechanic who requests a tool at a tool crib, or a coffee shop that stocks coffee for expected demand. These inventories are referred to as *anticipation stocks* because they are held to satisfy expected (i.e., *average*) demand.
- **To smooth production requirements.** Firms that experience variation in product demand often use inventory to achieve constant output during times of demand increases, and use inventory to “soak up” output that exceeds demand. Analogously, firms that experience seasonal patterns in demand often build up inventories during pre-season periods to meet overly high requirements during seasonal periods. These inventories are aptly named *seasonal inventories*. Stores that sell greeting cards, or winter or summer recreational equipment, have seasonal inventories.

LO12.3 Describe the main functions of inventories.

- **To decouple operations.** Companies can use inventories as buffers between successive operations to maintain continuity of production that would otherwise be disrupted by events such as breakdowns of equipment and accidents that cause a portion of the operation to shut down temporarily. The buffers permit other operations to continue temporarily while the problem is resolved. Similarly, firms have used buffers of raw materials to insulate production from disruptions in deliveries from suppliers, and finished goods inventory to buffer sales operations from manufacturing disruptions. More recently, companies have taken a closer look at buffer inventories, recognizing the cost and space they require, and realizing that finding and eliminating sources of disruptions can greatly decrease the need for decoupling operations.

Inventory buffers are also important in *supply chains*. Careful analysis can reveal points where buffers would be most useful, as well as points where they would merely increase costs without adding value.

- **To reduce the risk of stockouts.** Delayed deliveries and unexpected increases in demand increase the risk of shortages. Delays can occur because of weather conditions, supplier stockouts, deliveries of wrong materials, quality problems, and so on. The risk of shortages can be reduced by holding *safety stocks*, which are stocks in excess of expected demand to compensate for *variabilities* in demand and lead time.
- **To take advantage of order cycles.** To minimize purchasing and inventory costs, a firm often buys in quantities that exceed immediate requirements. This necessitates storing some or all of the purchased amount for later use. Similarly, it is usually economical to produce in large rather than small quantities. Again, the excess output must be stored for later use. Thus, inventory storage enables a firm to buy and produce in *economic lot sizes* without having to try to match purchases or production with demand requirements in the short run. This results in *periodic* orders or *order cycles*.
- **To hedge against price increases.** If a firm anticipates a substantial price increase is about to occur, it might decide to purchase a larger-than-normal amount to beat the increase.
- **To permit operations.** The fact that production operations take a certain amount of time (i.e., they are not instantaneous) means there will generally be some work-in-process inventory. In addition, intermediate stocking of goods—including raw materials, semifinished items, and finished goods at production sites, as well as goods stored in warehouses—leads to *pipeline* inventories throughout a production-distribution system. **Little's Law** can be useful in quantifying pipeline inventory. It states that the average amount of inventory in a system is equal to the product of the average rate at which inventory units leave the system (i.e., the average demand rate) and the average time a unit is in the system. Thus, if units are in the system for an average of 10 days, and the demand rate is 5 units per day, the average inventory is 50 units: $5 \text{ units/day} \times 10 \text{ days} = 50 \text{ units}$.
- **To take advantage of quantity discounts.** Suppliers may give discounts on large orders, opening the possibility of saving money by purchasing goods in large quantities.

Little's Law The average amount of inventory in a system is equal to the product of the average demand rate and the average time a unit is in the system.

Objective of Inventory Management

Inadequate control of inventories can result in both under- and overstocking of items. Understocking results in missed deliveries, lost sales, dissatisfied customers, and production bottlenecks; overstocking unnecessarily takes up space and ties up funds that might be more productive elsewhere. Although overstocking may appear to be the lesser of the two evils, the price tag for excessive overstocking can be staggering when inventory holding costs are high, and matters can easily get out of hand.

The overall objective of inventory management is to achieve satisfactory levels of *customer service*, while keeping inventory *costs* within reasonable bounds. The two basic issues (decisions) for inventory management are *when to order* and *how much to order*. The greater part of this chapter is devoted to models that can be applied to assist in making those decisions.

Managers have a number of performance measures they can use to judge the effectiveness of inventory management. The most obvious, of course, are costs and customer satisfaction, which they might measure by the number and quantity of backorders and/or customer complaints. A widely used measure is inventory turns, or **inventory turnover**, which is the ratio of annual cost of goods sold to average inventory investment. The turnover ratio indicates how many times a year the inventory is sold. Generally, the higher the ratio, the better, because that implies more efficient use of inventories. However, the desirable number of turns depends on the industry and what the profit margins are. The higher the profit margins, the lower the acceptable number of inventory turns, and vice versa. Also, a product that takes a long time to manufacture, or a long time to sell, will have a low turnover rate. This is often the case with high-end retailers (high profit margins). Conversely, supermarkets (low profit margins) have a fairly high turnover rate. Note, though, that there should be a balance between inventory investment and maintaining good customer service. Managers often use inventory turnover to evaluate inventory management performance. Monitoring this metric over time can yield insights into changes in performance.

Another useful measure is days of inventory on hand, a number that indicates the expected number of days of sales that can be supplied from existing inventory. Here, a balance is desirable: A high number of days might imply excess inventory, while a low number might imply a risk of running out of stock.

Inventory turnover Ratio of annual cost of goods sold to average inventory investment.

12.3 REQUIREMENTS FOR EFFECTIVE INVENTORY MANAGEMENT

Management has two basic functions concerning inventory. One is to establish a system to keep track of items in inventory, and the other is to make decisions about how much and when to order. To be effective, management must have the following:

1. A system to **keep track of the inventory** on hand and on order.
2. A reliable **forecast of demand** that includes an indication of possible *forecast error*.
3. Knowledge of **lead times** and **lead time variability**.
4. Reasonable estimates of inventory **holding costs**, **ordering costs**, and **shortage costs**.
5. A **classification system** for inventory items.

Let's take a closer look at each of these requirements.

Inventory Counting Systems

Inventory counting systems can be periodic or perpetual. Under a **periodic system**, a physical count of items in inventory is made at periodic, fixed intervals (e.g., weekly, monthly) in order to decide how much to order of each item. Then, the manager estimates how much will be demanded prior to the next delivery period and bases the order quantity on that information. An advantage of this type of system is that orders for many items occur at the same time, which can result in economies in processing and shipping orders. There are also several disadvantages of periodic reviews. One is a lack of control between reviews. Another is the need to protect against shortages between review periods by carrying extra stock.

A **perpetual inventory system** (also known as a *continuous review* system) keeps track of removals from inventory on a continuous basis, so the system can provide information on the current level of inventory for each item. When the amount on hand reaches a predetermined minimum, a fixed quantity, Q , is ordered. An obvious advantage of this system is the control provided by the continuous monitoring of inventory withdrawals. Another advantage is the fixed-order quantity; management can determine an optimal order quantity. One disadvantage of this approach is the added cost of record keeping. Moreover, a physical count of inventories must still be performed periodically to verify records because of possible errors, pilferage, spoilage, and other factors that can reduce the effective amount of inventory. Bank transactions such as customer deposits and withdrawals are examples of continuous recording of inventory changes.

LO12.4 Discuss the main requirements for effective management.

Periodic system Physical count of items in inventory made at periodic intervals (weekly, monthly).

LO12.5 Explain periodic and perpetual review systems.

Perpetual inventory system System that keeps track of removals from inventory continuously, thus monitoring current levels of each item.

Two-bin system Two containers of inventory; reorder when the first is empty.

Universal product code (UPC) Bar code printed on a label that has information about the item to which it is attached.

Point-of-sale (POS) system
Record items at time of sale.

Poor inventory accuracy leads to too much inventory or shortages. Software systems maintain enormous amounts of data and have a great amount of functionality. Systems can analyze inventory levels, allocate stock plan purchases, and allocate deliveries accordingly. They can identify key suppliers of each stocked item and can give lead times and dock-to-stock times for realistic time-phasing.

Perpetual systems range from very simple to very sophisticated. A **two-bin system**, a very elementary system, uses two containers for inventory. Items are withdrawn from the first bin until its contents are exhausted. It is then time to reorder. Sometimes an order card is placed at the bottom of the first bin. The second bin contains enough stock to satisfy expected demand until the order is filled, plus an extra cushion of stock that will reduce the chance of a stockout if the order is late or if usage is greater than expected. The advantage of this system is that there is no need to record each withdrawal from inventory; the disadvantage is that the reorder card may not be turned in for a variety of reasons (e.g., misplaced, the person responsible forgets to turn it in).

Supermarkets, discount stores, and department stores have always been major users of periodic counting systems. Today, most have switched to computerized checkout systems using a laser scanning device that reads a **universal product code (UPC)**, or *bar code*, printed on an item tag or on packaging. A typical grocery product code is illustrated here:



The zero on the left of the bar code identifies this as a grocery item, the first five numbers (14800) indicate the manufacturer (Mott's), and the last five numbers (23208) indicate the specific item (natural-style applesauce). Items in small packages, such as candy and gum, use a six-digit number.

Point-of-sale (POS) systems electronically record actual sales. Knowledge of actual sales can greatly enhance forecasting and inventory management: By relaying information about actual demand in real time, these systems enable management to make any necessary changes to restocking decisions. These systems are being increasingly emphasized as an important input to effective supply chain management by making this information available to suppliers.

UPC scanners represent major benefits to supermarkets. In addition to their increase in speed and accuracy, these systems give managers continuous information on inventories, reduce the need for periodic review and order-size determinations, and improve the level of customer service by indicating the price and quantity of each item on the customer's receipt.



DreamPictures/Shannon Faulk/Getty Images



Keeping track of inventories in-house and throughout a supply chain is vitally important for manufacturing, service, and retail operations. Bar codes have long been used for that purpose, but they carry only a limited amount of information and require direct line-of-sight to be scanned. Radio frequency identification (RFID) tags are a technological breakthrough in inventory management, providing real-time information that increases the ability to track and process shipping containers, parts in warehouses, items on supermarket shelves, and a whole lot more. They carry much more information than bar codes, and they don't require line-of-sight to be scanned.

RFID tags transmit product information or other data to network-connected RFID readers via radio waves. Tags attached to pallets, boxes, or individual items can enable a business to identify, track, monitor, or locate any object that is within range of a reader. For example, the tags are used in "speed passes" for toll roads.

In agriculture, fruit growers might use RFID tags to constantly monitor temperatures around fruit during shipping. This ensures that the fruit is kept at the appropriate temperature. The tags can be used for a wide range of agricultural products, containing information such as cultivation history, as well as whether the fruit is organically grown and what fertilizers or chemicals have been used.

Because major retail chains, such as Walmart and Target, and governmental agencies now require their suppliers to use RFID tags, many companies have already made RFID a priority in their business strategies.

Although RFID technology holds the potential for improved safety, convenience, and inventory management, widespread adoption, particularly in retail operations, could take several years. Until a global standard is established and cheap disposable tags are developed, the main areas of growth continue to be in nonretail operations.

Bar coding is important for other sectors of business besides retailing. Manufacturing and service industries benefit from the simplified production and inventory control it provides. In manufacturing, bar codes attached to parts, subassemblies, and finished goods greatly facilitate counting and monitoring activities. Automatic routing, scheduling, sorting, and packaging can also be done using bar codes. In health care, the use of bar codes can help to reduce drug-dispensing errors.

Stock keeping units (SKUs) are particularly helpful in retail businesses to track inventory items and sales. Unlike UPC codes, which are universal, SKUs are alphanumeric codes unique to each business. They can be used to identify a product's traits such as brand, size, color, price, and customer type (e.g., adult, child, gender). Each symbol in the code represents a product characteristic. Typically, the symbols are arranged from highest priority to lowest, relative to what customers want. So if brand is most important, the symbol representing that would appear first in the sequence.

Radio frequency identification (RFID) tags are also used to keep track of inventory in certain applications.

Demand Forecasts and Lead-Time Information

Inventories are used to satisfy demand requirements, so it is essential to have reliable estimates of the amount and timing of demand. Similarly, it is essential to know how long it will take for orders to be delivered. In addition, managers need to know the extent to which demand and **lead time** (the time between submitting an order and receiving it) might vary; the greater the potential variability, the greater the need for additional stock to reduce the risk of a shortage between deliveries. Thus, there is a crucial link between forecasting and inventory management.

Inventory Costs

Four basic costs are associated with inventories: purchase, holding, ordering, and shortage costs.

Purchase cost is the amount paid to a vendor or supplier to buy the inventory. It can include shipping cost. Purchase cost is typically the largest of all inventory costs.

Holding, or carrying, costs relate to physically having items in storage. Costs include interest, insurance, taxes (in some states), depreciation, obsolescence, deterioration, spoilage, pilferage, breakage, tracking, picking items from inventory, and warehousing costs (heat, light, rent, workers, equipment, security). They also include opportunity costs associated with having funds that could be used elsewhere tied up in inventory. Note that it is the *variable* portion of these costs that is pertinent.

Lead time Time interval between ordering and receiving the order.

Purchase cost The amount paid to buy the inventory.

Holding (carrying) cost Cost to carry an item in inventory for a length of time, usually a year.

LO12.6 Describe the costs that are relevant for inventory management.



CATCH THEM BEFORE THEY STEAL! REDUCING INVENTORY LOSS WITH AN ASSIST FROM AI

BY LISA SPENCER

In retail, shoplifting is the leading cause of inventory shrinkage. Typically, \$34 billion of inventory disappears from global retailers' shelves due to pilferage, equal to about 2 percent of sales. Now, startups like Japan's Vaak and the UK's Third Eye offer a new solution to avert pilferage. First, use existing security cameras to capture footage of shoppers. Next, add artificial intelligence software to run algorithms that detect unusual body language, like fidgeting or restlessness, which are often precursors to theft. Then, alert security staff via a smartphone app so they can intervene before the crime happens. Prevention is the goal, and usually, if

the shopper is intercepted and asked if they need assistance, they don't carry out the crime.

Several dozen stores in Tokyo are testing Vaak's software, and the company hopes to be in 100,000 Japanese stores in the next three years. Meanwhile, Third Eye's software is helping a major UK grocery chain with a similar system that it hopes to roll out elsewhere in Europe soon.

Based on: Lisa Du and Ayaka Maki, "These Cameras Can Spot Shoplifters Even Before They Steal." Bloomberg, March 4, 2019. <https://www.bloomberg.com/news/articles/2019-03-04/the-ai-cameras-that-can-spot-shoplifters-even-before-they-steal>

The significance of the various components of holding cost depends on the type of item involved, although taxes, interest, and insurance are generally based on the dollar value of an inventory. Items that are easily concealed (e.g., smartphones, calculators) or fairly expensive (cars, TVs) are prone to theft. Fresh seafood, meats and poultry, produce, and baked goods are subject to rapid deterioration and spoilage. Dairy products, salad dressings, medicines, and batteries also have limited shelf lives.

Holding costs are stated in either of two ways: as a percentage of unit price or as a dollar amount per unit. Typical annual holding costs range from 20 to 40 percent or more of the value of an item. In other words, to hold a \$100 item in inventory for one year could cost from \$20 to \$40.

Ordering costs are the costs of ordering and receiving inventory. They are the costs that occur with the actual placement of an order. They include determining how much is needed, preparing invoices, inspecting goods upon arrival for quality and quantity, and moving the goods to temporary storage. Ordering costs are generally expressed as a fixed dollar amount per order, regardless of order size.

When a firm produces its own inventory instead of ordering it from a supplier, machine **setup costs** (e.g., preparing equipment for the job by adjusting the machine, changing cutting tools) are analogous to ordering costs; that is, they are expressed as a fixed charge per production run, regardless of the size of the run.

Shortage costs result when demand exceeds the supply of inventory on hand. These costs can include the opportunity cost of not making a sale, loss of customer goodwill, late charges, backorder costs, and similar costs. Furthermore, if the shortage occurs in an item carried for internal use (e.g., to supply an assembly line), the cost of lost production or downtime is considered a shortage cost. Such costs can easily run into hundreds of dollars a minute or more. Shortage costs are sometimes difficult to measure, and they may be subjectively estimated.

Classification System

An important aspect of inventory management is that items held in inventory are not of equal importance in terms of dollars invested, profit potential, sales or usage volume, or stockout penalties. Therefore, it would be unrealistic to devote equal attention to each of these items. Instead, a more reasonable approach would be to allocate control efforts according to the *relative importance* of various items in inventory.

The **A-B-C approach** classifies inventory items according to some measure of importance, usually annual dollar value (i.e., dollar value per unit multiplied by annual usage rate), and then allocates control efforts accordingly. Typically, three classes of items are used: A (very important), B (moderately important), and C (least important). However, the actual number of categories may vary from organization to organization, depending on the extent to which a firm wants to differentiate control efforts. With three classes of items, A items generally only account for about 10 to 20 percent of the *number* of items in inventory, but about 60 to 70 percent of the *annual dollar value*. At the other end of the scale, C items might account for about 50 to 60 percent of the number of items but only about 10 to 15 percent of the dollar value of an inventory. These percentages vary from firm to firm, but in most instances a

Ordering costs Costs of ordering and receiving inventory.

Setup costs The costs involved in preparing equipment for a job.

Shortage costs Costs resulting when demand exceeds the supply of inventory; often unrealized profit per unit.

LO12.7 Describe the A-B-C approach and explain how it is useful.

A-B-C approach Classifying inventory according to some measure of importance, and allocating control efforts accordingly.



Digital Vision/Getty Images

A warehouse worker is retrieving (picking) items from inventory storage.

relatively small number of items will account for a large share of the value or cost associated with an inventory, and these items should receive a relatively greater share of control efforts. For instance, A items should receive close attention through frequent reviews of amounts on hand and control over withdrawals, where possible, to make sure that customer service levels are attained. The C items should receive only loose control (two-bin system, bulk orders), and the B items should have controls that lie between the two extremes.

Note that C items are not necessarily *unimportant*; incurring a stockout of C items such as the nuts and bolts used to assemble manufactured goods can result in a costly shutdown of an assembly line. However, due to the low annual dollar value of C items, there may not be much additional cost incurred by ordering larger quantities of some items, or ordering them a bit earlier.

Figure 12.1 illustrates the A-B-C concept.

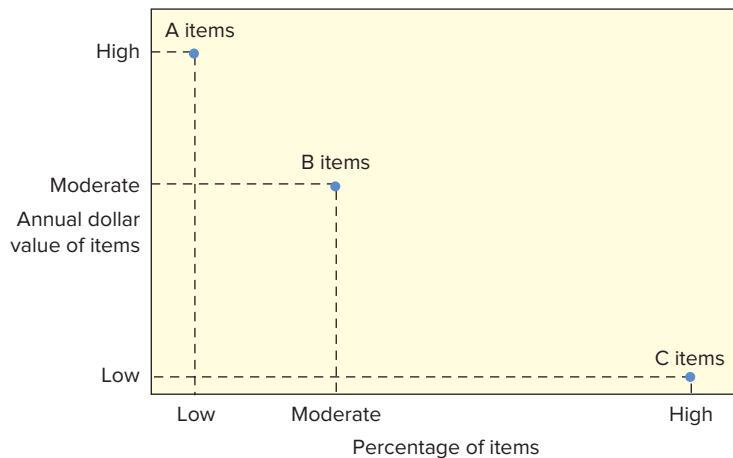

FIGURE 12.1
A typical A-B-C breakdown in relative annual dollar value of items and number of items by category

To conduct an A-B-C analysis, follow these steps:

1. For each item, multiply annual volume by unit price to get the annual dollar value.
2. Arrange annual dollar values in descending order.
3. The few (10 to 15 percent) with the highest annual dollar value are A items. The most (about 50 percent) with the lowest annual dollar value are C items. Those in between (about 35 percent) are B items.

EXAMPLE 1

Determining A, B, and C Designations

excel

mhhe.com/stevenson14e

A manager has obtained a list of unit costs and estimated annual demands for 10 inventory items and now wants to categorize the items on an A-B-C basis. Multiplying each item's annual demand by its unit cost yields its annual dollar value:

Item Number	Annual Demand (00)	×	Unit Cost	=	Annual Dollar Value (00)
1	25		\$ 360		\$ 9,000
2	10		70		700
3	24		500		12,000
4	15		100		1,500
5	7		70		490
6	10		1,000		10,000
7	2		210		420
8	10		4,000		40,000
9	80		10		800
10	5		200		1,000
					<u>75,910</u>

SOLUTION

Arranging the annual dollar values in descending order can facilitate assigning items to categories:

Item Number	Annual Dollar Value	Classification	Percentage of Items	Percentage of Annual Dollar Value
8	\$40,000	A	10	52.7
3	12,000	B	30	40.8
6	10,000	B		
1	9,000	B		
4	1,500	C	60	6.5
10	1,000	C		
9	800	C		
2	700	C		
5	490	C		
7	420	C		
	<u>75,910</u>		<u>100</u>	<u>100</u>

Note that category A has the fewest number of items but the highest percentage of annual dollar value, while category C has the most items but only a small percentage of the annual dollar value.

Although annual dollar value may be the primary factor in classifying inventory items, a manager may take other factors into account in making exceptions for certain items (e.g., changing the classification of a B item to an A item). Factors may include the risk of obsolescence, the risk of a stockout, the distance of a supplier, and so on.



DRONES CAN HELP WITH INVENTORY MANAGEMENT IN WAREHOUSES

BY LISA SPENCER

Ryder, well known for its fleet of rental trucks as well as its supply chain management products, uses drones to scan pallets at some customers' warehouses. In one instance, the process took 20 minutes instead of the 90 minutes required for a manual scan. The drone also did a cycle count of the whole warehouse in three hours instead of the two days required for human workers. Drones are also used to find pallet locations for product placement and to verify that placements are correct.

Question

What other applications of drones have you heard or read about?

Based on: "Ryder redefines the smart warehouse," Fleet Owner, January 18, 2019, <https://www.fleetowner.com/technology/ryder-redefines-smart-warehouse>

Managers use the A-B-C concept in many different settings to improve operations. One key use occurs in customer service, where a manager can focus attention on the most important aspects of customer service by categorizing different aspects as very important, important, or of only minor importance. The point is to not overemphasize minor aspects of customer service at the expense of major aspects.

Another application of the A-B-C concept is as a guide to **cycle counting**, which is a physical count of items in inventory. One purpose of cycle counting is to reduce discrepancies between the amounts indicated by inventory records and the actual quantities of inventory on hand. Accuracy is important because inaccurate records can lead to disruptions in operations, poor customer service, and unnecessarily high inventory carrying costs. Another purpose of cycle counting is to uncover and correct the causes of inventory discrepancies. Counts conducted more frequently than once a year can reduce the costs of inaccuracies compared to only doing an annual count, by allowing for investigation and correction of the causes of inaccuracies. Causes might involve theft (customers and employees), poor record keeping, or failure to note discrepancies in supplier deliveries.

Cycle counting A physical count of items in inventory.

The key questions concerning cycle counting for management are the following:

- How much accuracy is needed?
- When should cycle counting be performed?
- Who should do it?

APICS recommends the following guidelines for inventory record accuracy: within ± 0.2 percent for A items, ± 1.0 percent for B items, and ± 5.0 percent for C items. A items are counted frequently, B items are counted less frequently, and C items are counted the least frequently.

Some companies use certain events to trigger cycle counting, whereas others do it on a periodic (scheduled) basis. Events that can trigger a physical count of inventory include an out-of-stock report written on an item indicated by inventory records to be in stock, an inventory report that indicates a low or zero balance of an item, and a specified level of activity (e.g., every 2,000 units sold).

Some companies use regular stockroom personnel to do cycle counting during periods of slow activity, while others contract with outside firms to do it on a periodic basis. Use of an outside firm provides an independent check on inventory and may reduce the risk of problems created by dishonest employees. Still other firms maintain full-time personnel to do cycle counting.

12.4 INVENTORY ORDERING POLICIES

Inventory ordering policies address the two basic issues of inventory management:

- How much to order
- When to order

In the following sections, a number of models are described that are used for these issues. The discussion begins with the issue of how much to order.

12.5 HOW MUCH TO ORDER: ECONOMIC ORDER QUANTITY MODELS

Economic order quantity (EOQ) The order size that minimizes total annual cost.

LO12.8 Describe the basic EOQ model and its assumptions and solve typical problems.

The question of how much to order can be determined by using an **economic order quantity (EOQ)** model. EOQ models identify the optimal order quantity by minimizing the sum of certain annual costs that vary with order size and order frequency. Three order-size models are described here:

- The basic economic order quantity model
- The economic production quantity model
- The quantity discount model

Basic Economic Order Quantity (EOQ) Model

The basic EOQ model is the simplest of the three models. It is used to identify a *fixed* order size that will minimize the sum of the annual costs of holding inventory and ordering inventory. The unit purchase price of items in inventory is not generally included in the total cost because the unit cost is unaffected by the order size unless quantity discounts are a factor. If holding costs are specified as a percentage of unit cost, then unit cost is indirectly included in the total cost as a part of holding costs.

The basic model involves a number of assumptions. They are listed in Table 12.1.

Inventory ordering and usage occur in cycles. Figure 12.2 illustrates several inventory cycles. A cycle begins with receipt of an order of Q units, which are withdrawn at a constant rate over time. When the quantity on hand is just sufficient to satisfy demand during lead time, an order for Q units is submitted to the supplier. Because it is assumed that both the usage rate and the lead time do not vary, the order will be received at the precise instant that the inventory on hand falls to zero. Thus, orders are timed to avoid both excess stock and stockouts.

The optimal order quantity reflects a balance between carrying costs and ordering costs: As order size varies, one type of cost will increase while the other decreases. For example, if the order size is relatively small, the average inventory will be low, resulting in low carrying costs. However, a small order size will necessitate frequent orders, which will drive up annual ordering costs. Conversely, ordering large quantities at infrequent intervals can hold down annual ordering costs, but that would result in higher average inventory levels and therefore increased carrying costs. Figure 12.3 illustrates these two extremes.

Thus, the ideal solution is an order size that causes neither a few very large orders nor many small orders, but one that lies somewhere between. The exact amount to order will depend on the relative magnitudes of carrying and ordering costs.

Annual carrying cost is computed by multiplying the average amount of inventory on hand by the cost to carry one unit for one year, even though any given unit would not necessarily be held for a year. The average inventory is simply half of the order quantity: The amount on hand decreases steadily from Q units to 0, for an average of $(Q + 0)/2$, or $Q/2$. Using the symbol H to represent the average annual carrying cost per unit, the *total annual carrying cost* is

$$\text{Annual carrying cost} = \frac{Q}{2}H$$

where

Q = Order quantity in units

H = Holding (carrying) cost per unit per year

TABLE 12.1

Assumptions of the basic EOQ model

- Only one product is involved.
- Annual demand requirements are known.
- Demand is spread evenly throughout the year so that the demand rate is reasonably constant.
- Lead time is known and constant.
- Each order is received in a single delivery.
- There are no quantity discounts.

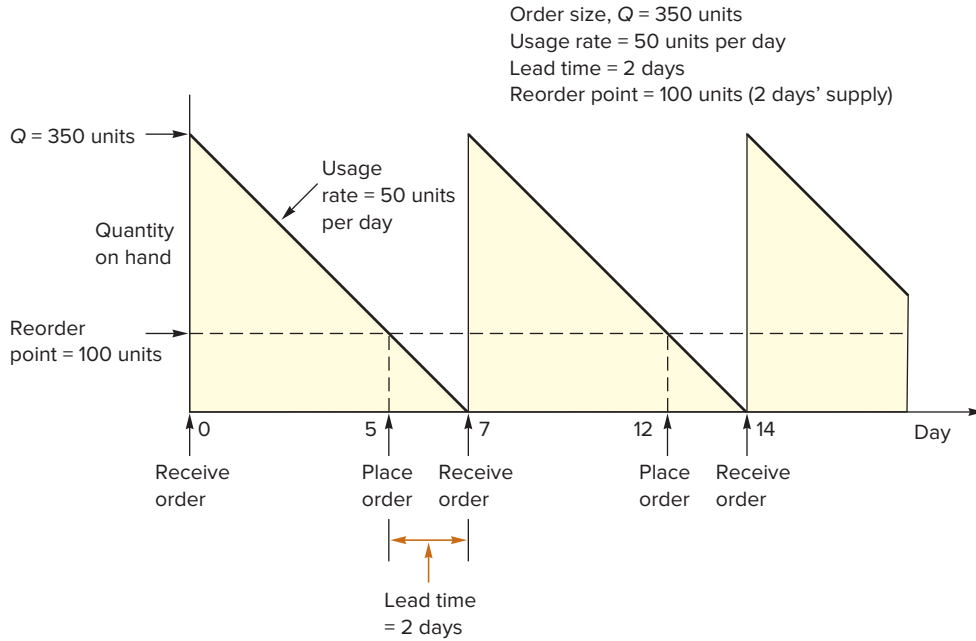

FIGURE 12.2
 The inventory cycle:
 profile of inventory level
 over time

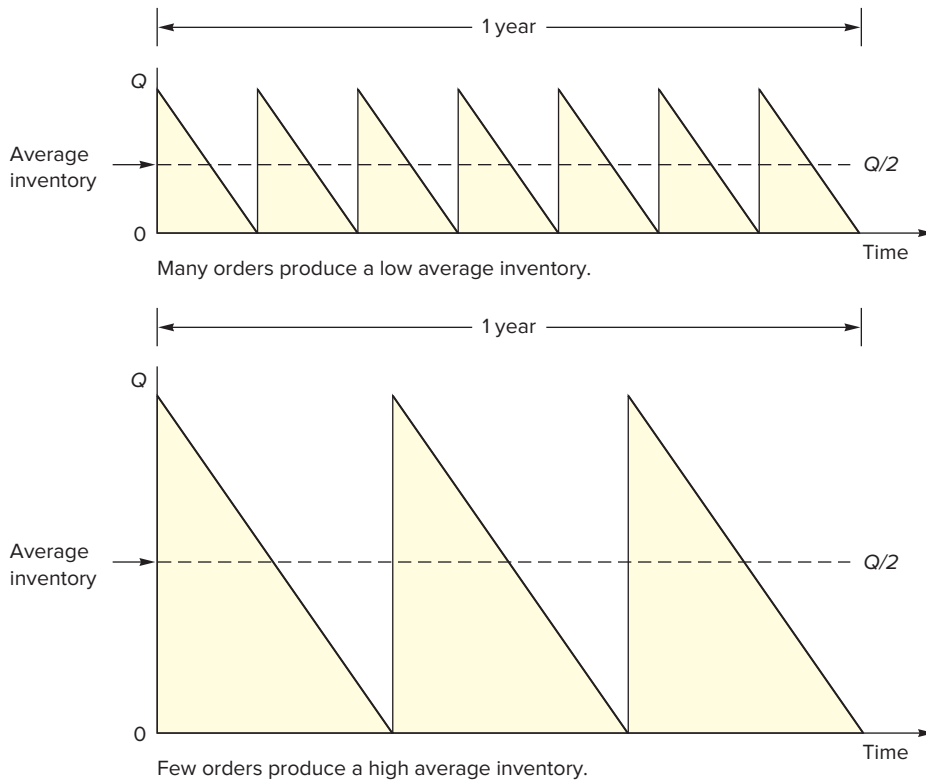
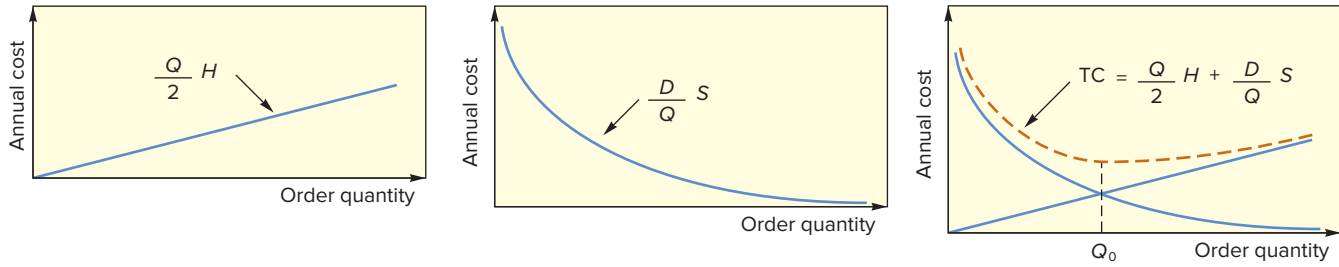

FIGURE 12.3
 Average inventory level
 and number of orders per
 year are inversely related:
 As one increases, the
 other decreases.

Carrying cost is thus a linear function of Q : Carrying costs increase or decrease in direct proportion to changes in the order quantity Q , as Figure 12.4A illustrates.

On the other hand, annual ordering cost will decrease as order size increases because, for a given annual demand, the larger the order size, the fewer the number of orders needed. For instance, if annual demand is 12,000 units and the order size is 1,000 units per order, there must be 12 orders over the year. But if $Q = 2,000$ units, only six orders will be needed; if $Q = 3,000$ units, only four orders will be needed. In general, the number of orders per year will be D/Q ,

FIGURE 12.4 Carrying cost, ordering cost, and total cost curve



A. Carrying costs are linearly related to order size.

B. Ordering costs are inversely and nonlinearly related to order size.

C. The total-cost curve is U-shaped.

where D = Annual demand and Q = Order size. Unlike carrying costs, ordering costs are relatively insensitive to order size; regardless of the amount of an order, certain activities must be done, such as determining how much is needed, periodically evaluating sources of supply, and preparing the invoice. Even inspection of the shipment to verify quality and quantity characteristics is not strongly influenced by order size because large shipments are sampled rather than completely inspected. Hence, ordering cost is treated as a constant. *Annual ordering cost* is a function of the number of orders per year and the ordering cost per order:

$$\text{Annual ordering cost} = S \frac{D}{Q}$$

where

D = Demand, usually in units per year

S = Ordering cost per order

Because the number of orders per year, D/Q , decreases as Q increases, annual ordering cost is inversely related to order size, as Figure 12.4B illustrates.

The total annual cost (TC) associated with carrying and ordering inventory when Q units are ordered each time is

$$\text{TC} = \underbrace{\text{Annual carrying cost}}_{\frac{Q}{2}H} + \underbrace{\text{Annual ordering cost}}_{\frac{D}{Q}S} = \frac{Q}{2}H + \frac{D}{Q}S \tag{12-1}$$

(Note that D and H must be in the same units, e.g., months, years.) Figure 12.4C reveals that the total-cost curve is U-shaped (i.e., convex, with one minimum) and that *it reaches its minimum at the quantity where carrying and ordering costs are equal*. An expression for the optimal order quantity, Q_0 , can be obtained using calculus.¹ The result is the formula

$$Q_0 = \sqrt{\frac{2DS}{H}} \tag{12-2}$$

Thus, given annual demand, the ordering cost per order, and the annual carrying cost per unit, one can compute the optimal (economic) order quantity. The minimum total cost is then found by substituting Q_0 for Q in Formula 12-1.

The length of an order cycle (i.e., the time between orders) is

$$\text{Length of order cycle} = \frac{Q}{D} \tag{12-3}$$

¹We can find the minimum point of the total-cost curve by differentiating TC with respect to Q , setting the result equal to zero, and solving for Q . Thus,

1. $\frac{dTC}{dQ} = H/2 - DS/Q^2$
2. $0 = H/2 - DS/Q^2$, so $Q^2 = \frac{2DS}{H}$ and $Q = \sqrt{\frac{2DS}{H}}$

Note that the second derivative is positive, which indicates a minimum has been obtained.

Computing and Using the EOQ

A local distributor for a national tire company expects to sell approximately 9,600 radial tires of a certain size and tread design next year. Annual carrying cost is \$16 per tire, and ordering cost is \$75. The distributor operates 288 days a year.

- What is the EOQ?
- How many times per year does the store reorder?
- What is the length of an order cycle?
- What will the total annual carrying and ordering cost be if the EOQ quantity is ordered?

EXAMPLE 2

excel
mhhe.com/stevenson14e

$$\begin{aligned} D &= 9,600 \text{ tires per year} \\ H &= \$16 \text{ per unit per year} \\ S &= \$75 \end{aligned}$$

- $Q_0 = \sqrt{\frac{2DS}{H}} = \sqrt{\frac{2(9,600)75}{16}} = 300 \text{ tires}$
- Number of orders per year: $D/Q = \frac{9,600 \text{ tires/year}}{300 \text{ tires/order}} = 32 \text{ orders}$
- Length of order cycle: $Q/D = \frac{300 \text{ tires}}{9,600 \text{ tires/year}} = 1/32 \text{ of a year, which is } 1/32 \times 288, \text{ or } 9 \text{ workdays.}$
- $$\begin{aligned} \text{TC} &= \text{Carrying cost} + \text{Ordering cost} \\ &= (Q/2)H + (D/Q)S \\ &= (300/2)16 + (9,600/300)75 \\ &= \$2,400 + \$2,400 \\ &= \$4,800 \end{aligned}$$

SOLUTION

Note that the ordering and carrying costs are equal at the EOQ, as illustrated in Figure 12.4C.

Carrying cost is sometimes stated as a percentage of the price of an item rather than as a dollar amount per unit. However, as long as the percentage is converted into a dollar amount, the EOQ formula is still appropriate.

Computing the EOQ

Piddling Manufacturing assembles security systems. It purchases 3,600 high-definition security cameras a year at \$180 each. Ordering costs are \$50, and annual carrying costs are 20 percent of the purchase price. Compute the optimal quantity and the total annual cost of ordering and carrying the inventory.

EXAMPLE 3

excel
mhhe.com/stevenson14e

$$\begin{aligned} D &= 3,600 \text{ security cameras per year} \\ S &= \$50 \\ H &= .20(\$180) = \$36 \\ Q_0 &= \sqrt{\frac{2DS}{H}} = \sqrt{\frac{2(3,600)(50)}{36}} = 100 \text{ security cameras} \end{aligned}$$

$$\begin{aligned} \text{TC} &= \text{Carrying costs} + \text{Ordering costs} \\ &= (Q_0/2)H + (D/Q_0)S \\ &= (100/2)36 + (3,600/100)50 \\ &= \$1,800 + \$1,800 = \$3,600 \end{aligned}$$

SOLUTION

Comment: Holding and ordering costs, and annual demand, are typically estimated values rather than values that can be precisely determined, say, from accounting records. Holding costs are sometimes *designated* by management rather than computed. Consequently, the EOQ should be regarded as an *approximate* quantity rather than an exact quantity. Thus, rounding the calculated value (to a whole number) is perfectly acceptable; stating a value to several decimal places would tend to give an unrealistic impression of the precision involved. In fact, businesses often round to the nearest case size, pallet size, or to a standard shipping size. An obvious question is: How good is this “approximate” EOQ in terms of minimizing cost? The answer is that the EOQ is fairly robust; the total cost curve is relatively flat near the EOQ. In other words, even if the order quantity differs from the actual EOQ, total costs will not increase much at all. This is particularly true for quantities larger than the real EOQ, because the total cost curve rises very slowly to the right of the EOQ. (See Figure 12.5.)

Because the total cost curve is relatively flat around the EOQ, there can be some flexibility to modify the order quantity a bit from the EOQ (say, to achieve a round lot or full truckload) without incurring much of an increase in total cost.

LO12.9 Describe the economic production quantity model and solve typical problems.

Economic Production Quantity (EPQ)

The batch mode is widely used in production. Even in assembly operations, portions of the work are done in batches. The reason for this is that in certain instances, the capacity to produce a part exceeds the part’s usage or demand rate. As long as production continues, inventory will continue to grow. In such instances, it makes sense to periodically produce such items in batches, or *lots*, instead of producing continually.

The assumptions of the EPQ model are similar to those of the EOQ model, except that instead of orders received in a single delivery, units are received incrementally during production. The assumptions are:

- Only one product is involved.
- Annual demand is known.
- The usage rate is constant.
- Usage occurs continually, but production occurs periodically.
- The production rate is constant when production is occurring.
- Lead time is known and constant.
- There are no quantity discounts.

Figure 12.6 illustrates how inventory is affected by periodically producing a batch of a particular item.

During the production phase of the cycle, inventory builds up at a rate equal to the difference between production and usage rates. For example, if the daily production rate is 20 units and the daily usage rate is 5 units, inventory will build up at the rate of $20 - 5 = 15$ units per day. As long as production occurs, the inventory level will continue to build; when production ceases, the inventory level will begin to decrease. Hence, the inventory level will be maximum at the point where production ceases. Inventory will then decrease at the constant usage rate. When the amount of inventory on hand is exhausted, production is resumed, and the cycle repeats itself.

FIGURE 12.5

The total cost curve is relatively flat near the EOQ.

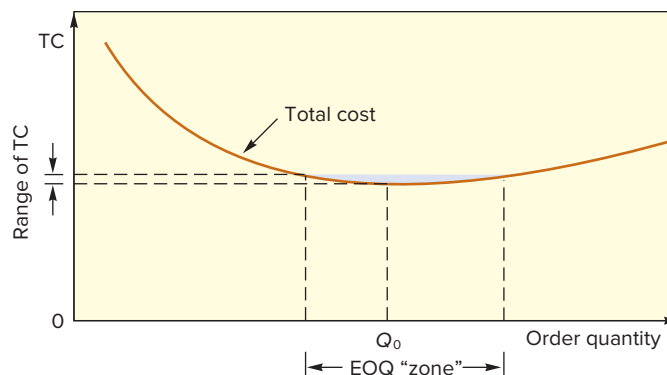

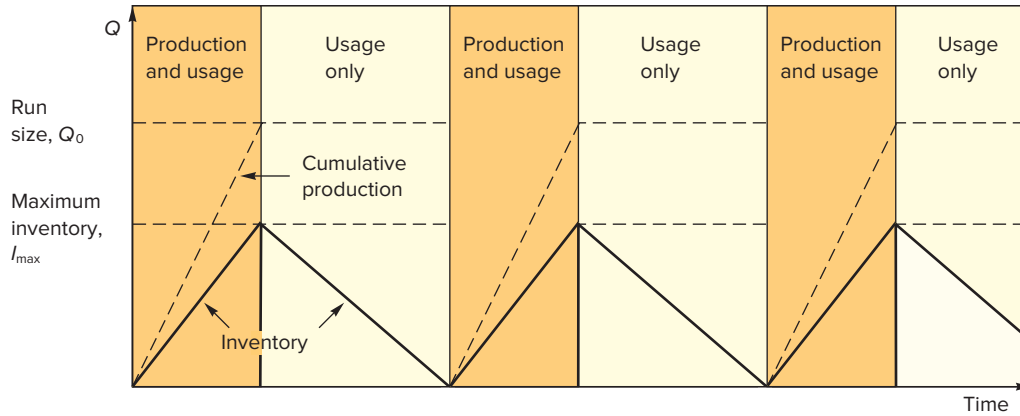

FIGURE 12.6
EPQ with incremental inventory buildup

Because the company makes the product itself, there are no ordering costs as such. Nonetheless, with every production run (batch) there are setup costs—the costs required to prepare the equipment for the job, such as cleaning, adjusting, and changing tools and fixtures. Setup costs are analogous to ordering costs because they are independent of the lot (run) size. They are treated in the formula in exactly the same way. The larger the run size, the fewer the number of runs needed and, therefore, the lower the annual setup cost. The number of runs or batches per year is D/Q , and the annual setup cost is equal to the number of runs per year times the setup cost, S , per run: $(D/Q)S$.

The total cost is

$$TC_{\min} = \text{Carrying cost} + \text{Setup cost} = \left(\frac{I_{\max}}{2}\right)H + \left(\frac{D}{Q}\right)S \quad (12-4)$$

where

I_{\max} = Maximum inventory

Unlike the EOQ case, where the entire quantity, Q , goes into inventory, in this case usage continually draws off some of the output, and what's left goes into inventory. So the inventory level will never be at the run size, Q_0 . You can see that in Figure 12.6.

The economic run quantity is

$$Q_p = \sqrt{\frac{2DS}{H}} \sqrt{\frac{p}{p-u}} \quad (12-5)$$

where

p = Production or delivery rate

u = Usage rate

Note: p and u must be in the same units (e.g., both in units per day, or units per week).

The cycle time (the time between setups of consecutive runs) for the economic run size model is a function of the run size and usage (demand) rate:

$$\text{Cycle time} = \frac{Q_p}{u} \quad (12-6)$$

Similarly, the run time (the production phase of the cycle) is a function of the run (lot) size and the production rate:

$$\text{Run time} = \frac{Q_p}{p} \quad (12-7)$$

The maximum and average inventory levels are

$$I_{\max} = \frac{Q_p}{p}(p-u) \quad \text{or} \quad Q_p - \left(\frac{Q_p}{p}\right)u \quad \text{and} \quad I_{\text{average}} = \frac{I_{\max}}{2} \quad (12-8)$$

EXAMPLE 4



Computing and Using the Production Lot Quantity

A toy manufacturer uses 48,000 rubber wheels per year for its popular dump truck series. The firm makes its own wheels, which it can produce at a rate of 800 per day. The toy trucks are assembled uniformly over the entire year. Carrying cost is \$1 per wheel a year. Setup cost for a production run of wheels is \$45. The firm operates 240 days per year. Determine the following:

- Optimal run size
- Minimum total annual cost for carrying and setup
- Cycle time for the optimal run size
- Run time

SOLUTION

$D = 48,000$ wheels per year

$S = \$45$

$H = \$1$ per wheel per year

$p = 800$ wheels per day

$u = 48,000$ wheels per 240 days, or 200 wheels per day

$$a. \quad Q_p = \sqrt{\frac{2DS}{H}} \sqrt{\frac{p}{p-u}} = \sqrt{\frac{2(48,000)45}{1}} \sqrt{\frac{800}{800-200}} = 2,400 \text{ wheels}$$

$$b. \quad TC_{\min} = \text{Carrying cost} + \text{Setup cost} = \left(\frac{I_{\max}}{2}\right)H + (D/Q_p)S$$

Thus, first compute I_{\max} :

$$I_{\max} = \frac{Q_p}{p}(p-u) = \frac{2,400}{800}(800-200) = 1,800 \text{ wheels}$$

$$TC = \frac{1,800}{2} \times \$1 + \frac{48,000}{2,400} \times \$45 = \$900 + \$900 = \$1,800$$

Note again the equality of cost (in this example, setup and carrying costs) at the EOQ.

$$c. \quad \text{Cycle time} = \frac{Q_p}{u} = \frac{2,400 \text{ wheels}}{200 \text{ wheels per day}} = 12 \text{ days}$$

Thus, a run of wheels will be made every 12 days.

$$d. \quad \text{Run time} = \frac{Q_p}{p} = \frac{2,400 \text{ wheels}}{800 \text{ wheels per day}} = 3 \text{ days}$$

Thus, each run will require three days to complete.

Quantity discounts Price reductions for larger orders.

Quantity Discounts

Quantity discounts are price reductions for larger orders offered to customers to induce them to buy in large quantities. For example, a Chicago surgical supply company publishes the price list shown in Table 12.2 for boxes of gauze strips. Notice how the price per box decreases as order quantity increases.

TABLE 12.2

Price list for extra-wide gauze strips

Order Quantity	Price per Box
1 to 44	\$2.00
45 to 69	1.70
70 or more	1.40

When quantity discounts are available, there are a number of questions that must be addressed to decide whether to take advantage of a discount. These include:

- Will storage space be available for the additional items?
- Will obsolescence or deterioration be an issue?
- Can we afford to tie up extra funds in inventory?

If the decision is made to take advantage of a quantity discount, the goal is to select the order quantity that will minimize total cost, where total cost is the sum of carrying cost, ordering cost, and purchasing (i.e., product) cost:

$$\begin{aligned}
 TC &= \text{Carrying cost} + \text{Ordering cost} + \text{Purchasing cost} \\
 &= \left(\frac{Q}{2}\right)H + \left(\frac{D}{Q}\right)S + PD \qquad (12-9)
 \end{aligned}$$

where

- Q = Order quantity
- H = Holding cost per unit (usually annual)
- D = Demand (usually annual)
- S = Ordering cost
- P = Unit price or cost

Recall that in the basic EOQ model, determination of order size does not involve the purchasing cost. The rationale for not including unit price is that under the assumption of no quantity discounts, price per unit is the same for all order sizes. Inclusion of unit price in the total-cost computation in that case would merely increase the total cost by the amount P times D . A graph of total annual purchase cost versus quantity would be a horizontal line. Hence, including purchasing costs would merely raise the total-cost curve by the same amount (PD) at every point. That would not change the EOQ. (See Figure 12.7.)

When quantity discounts are offered, there is a separate U-shaped total-cost curve for each unit price. Again, including unit prices merely raises each curve by a constant amount. However, because the unit prices are all different, each curve is raised by a different amount: Smaller unit prices will raise a total-cost curve less than larger unit prices. Note that no one curve applies to the entire range of quantities; each curve applies to only a *portion* of the range. (See Figure 12.8.) Hence, the applicable or *feasible* total cost is initially on the curve with the highest unit price and

LO12.10 Describe the quantity discount model and solve typical problems.

FIGURE 12.7
Adding PD doesn't change the EOQ.

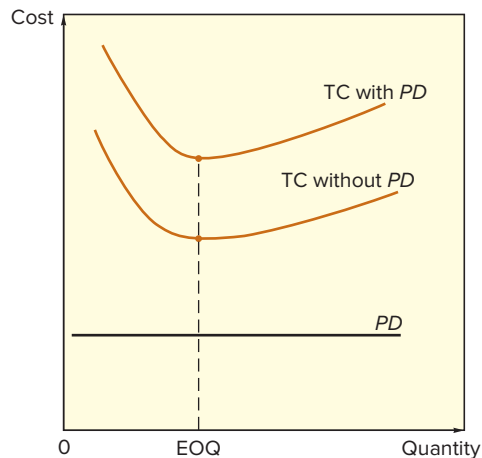
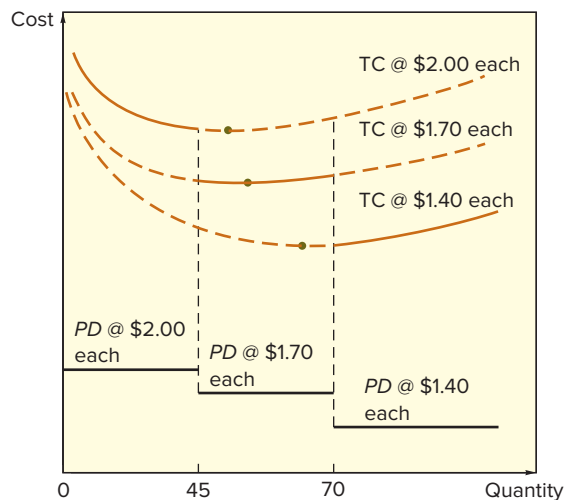

FIGURE 12.8
The total-cost curve with quantity discounts is composed of a portion of the total-cost curve for each price.



then drops down, curve by curve, at the *price breaks*, which are the minimum quantities needed to obtain the discounts. Thus, in Table 12.2, the price breaks for gauze strips are at 45 and 70 boxes. The result is a total-cost curve with *steps* at the price breaks.

Even though each curve has a minimum, those points are not necessarily feasible. For example, the minimum point for the \$1.40 curve in Figure 12.8 appears to be about 65 units. However, the price list shown in Table 12.2 indicates that an order size of 65 boxes will involve a unit price of \$1.70. The actual total-cost curve is denoted by the solid lines; only those price–quantity combinations are feasible. The objective of the quantity discount model is to identify the order quantity that will represent the lowest total cost for the entire set of curves.

Analysis of quantity discount problems differs slightly, depending on whether holding costs are independent of unit price (i.e., constant), or whether they are a percentage of unit price. The following table illustrates the two ways, using 20 percent to illustrate holding costs that are a percentage of unit price.

Order Quality	Unit Price	H constant @ \$4	H 20% of Unit Price
1 to 99	\$10	4	.20(10) = 2.00
100 to 299	9	4	.20(9) = 1.80
300 or more	8	4	.20(8) = 1.60

When carrying costs are constant, there will be a single minimum point. All curves will have their minimum point at the same quantity. Consequently, the total-cost curves line up vertically, differing only in that the lower unit prices are reflected by lower total-cost curves as shown in Figure 12.9A. (For purposes of illustration, the horizontal purchasing cost lines have been omitted.)

When carrying costs are specified as a percentage of unit price, each curve will have a different minimum point. Because carrying costs are a percentage of price, lower prices will mean lower carrying costs and larger minimum points. Thus, as price decreases, each curve’s minimum point will be to the right of the next higher curve’s minimum point. (See Figure 12.9B.)

The procedure for determining the overall EOQ differs slightly, depending on which of these two cases is relevant. For carrying costs that are constant, the procedure is as follows:

1. Compute the common minimum point, and then identify the price range in which the minimum point is feasible.

FIGURE 12.9 Comparison of TC curves for constant carrying costs and carrying costs that are a percentage of unit costs

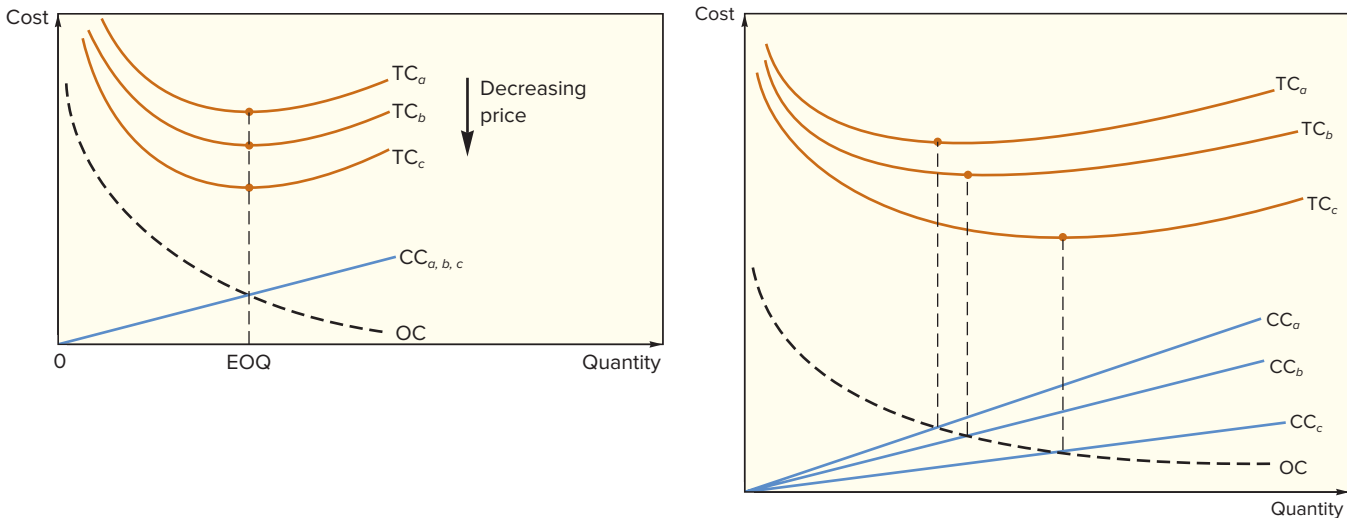

A. When carrying costs are constant, all curves have their minimum points at the same quantity.

B. When carrying costs are stated as a percentage of unit price, the minimum points do not line up.

- If the minimum point is feasible in the lowest cost price range, that is the optimal order quantity.
- If the minimum point is in a higher cost range, compute the total cost for the feasible minimum point and for the price break quantity (i.e., small quantity to buy for that unit price), being sure to include the purchase cost.; the quantity (minimum point or price break quantity) that yields the lowest total cost is the optimal order quantity.

Determining the Optimal Order Quantity When There Are Quantity Discounts and Carrying Costs Are Constant

EXAMPLE 5

excel

mhhe.com/stevenson14e

The maintenance department of a large hospital uses about 816 cases of liquid cleanser annually. Ordering costs are \$12, carrying costs are \$4 per case a year, and the new price schedule indicates that orders of less than 50 cases will cost \$20 per case, 50 to 79 cases will cost \$18 per case, 80 to 99 cases will cost \$17 per case, and larger orders will cost \$16 per case. Determine the optimal order quantity and the total cost.

See Figure 12.10:

SOLUTION

$$D = 816 \text{ cases per year} \quad S = \$12 \quad H = \$4 \text{ per case per year}$$

Range	Price
1 to 49	\$20
50 to 79	18
80 to 99	17
100 or more	16

- Compute the common minimum quantity

$$Q = \sqrt{\frac{2DS}{H}} = \sqrt{\frac{2(816)12}{4}} = 69.97 \approx 70 \text{ cases}$$

Note: The curves are shown for illustration. You do not need to draw the curves.

- The 70 cases can be bought at \$18 per case because 70 falls in the range of 50 to 79 cases. The total cost to purchase 816 cases a year, at the rate of 70 cases per order, will be

$$\begin{aligned} TC_{70} &= \text{Carrying cost} + \text{Order cost} + \text{Purchase cost} \\ &= (Q/2)H + (D/Q)S + PD \\ &= (70/2)4 + (816/70)12 + 18(816) = \$14,968 \end{aligned}$$

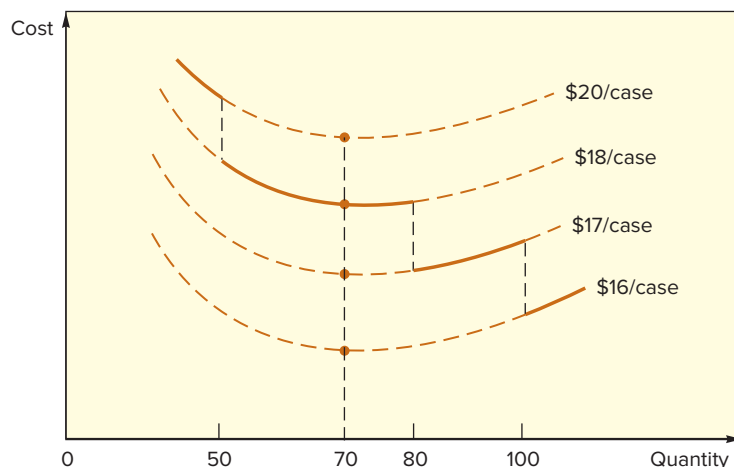

FIGURE 12.10
Total-cost curves for
Example 5

SOLUTION

Because lower cost ranges exist, each must be checked against the minimum cost generated by 70 cases at \$18 each. In order to buy at \$17 per case, at least 80 cases must be purchased. (Because the TC curve is rising, 80 cases will have the lowest TC for that curve's feasible region.) The total cost at 80 cases will be

$$TC_{80} = (80/2)4 + (816/80)12 + 17(816) = \$14,154$$

To obtain a cost of \$16 per case, at least 100 cases per order are required, and the total cost at that price break will be

$$TC_{100} = (100/2)4 + (816/100)12 + 16(816) = \$13,354$$

Therefore, because 100 cases per order yields the lowest total cost, 100 cases is the overall optimal order quantity.

When carrying costs are expressed as a percentage of price, determine the best purchase quantity with the following procedure:

1. Beginning with the lowest unit price, compute the minimum points for each price range until you find a feasible minimum point (i.e., until a minimum point falls in the quantity range for its price).
2. If the minimum point for the lowest unit price is feasible, it is the optimal order quantity. If the minimum point is not feasible in the lowest price range, compare the total cost at the price break for all *lower* price ranges with the total cost of the feasible minimum point. The quantity that yields the lowest total cost is the optimum.

EXAMPLE 6**eXcel**

mhhe.com/stevenson14e

Determining the Optimal Order Quantity When There Are Quantity Discounts and Carrying Costs Are a Percentage of Unit Prices

Surge Electric uses 4,000 toggle switches a year. Switches are priced as follows: 1 to 499, 90 cents each; 500 to 999, 85 cents each; and 1,000 or more, 80 cents each. It costs approximately \$30 to prepare an order and receive it, and carrying costs are 40 percent of purchase price per unit on an annual basis. Determine the optimal order quantity and the total annual cost.

SOLUTION

See Figure 12.11:

FIGURE 12.11
Total-cost curves for
Example 6

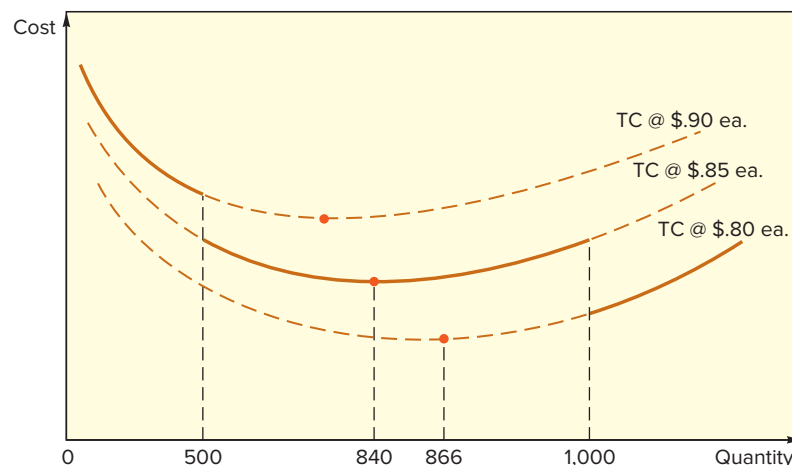

$$D = 4,000 \text{ switches per year} \quad S = \$30 \quad H = .40P$$

Range	Unit Price	H
1 to 499	\$.90	.40(.90) = .36
500 to 999	\$.85	.40(.85) = .34
1,000 or more	\$.80	.40(.80) = .32

Find the minimum point for each price, starting with the lowest price, until you locate a feasible minimum point.

$$\text{Minimum point}_{.80} = \sqrt{\frac{2DS}{H}} = \sqrt{\frac{2(4,000)30}{.32}} = 866 \text{ switches}$$

Because an order size of 866 switches will cost \$.85 each rather than \$.80 each, 866 is not a feasible minimum point for \$.80 per switch. Next, try \$.85 per unit.

$$\text{Minimum point}_{.85} = \sqrt{\frac{2(4,000)30}{.34}} = 840 \text{ switches}$$

This is feasible; it falls in the \$.85 per switch range of 500 to 999.

Now compute the total cost for 840, and compare it to the total cost of the minimum quantity necessary to obtain a price of \$.80 per switch.

$$\begin{aligned} \text{TC} &= \text{Carrying costs} + \text{Ordering costs} + \text{Purchasing costs} \\ &= \left(\frac{Q}{2}\right)H + \left(\frac{D}{Q}\right)S + PD \end{aligned}$$

$$\text{TC}_{840} = \frac{840}{2}(.34) + \frac{4,000}{840}(30) + .85(4,000) = \$3,686$$

$$\text{TC}_{1000} = \frac{1,000}{2}(.32) + \frac{4,000}{1,000}(30) + .80(4,000) = \$3,480$$

Thus, the minimum-cost order size is 1,000 switches.

12.6 REORDER POINT ORDERING

EOQ models answer the question of how much to order, but not the question of when to order. The latter is the function of models that identify the **reorder point (ROP)** in terms of a *quantity*: The reorder point occurs when the quantity on hand drops to a predetermined amount. That amount generally includes expected demand during lead time and perhaps an extra cushion of stock, which serves to reduce the probability of experiencing a stockout during lead time. Note that in order to know when the reorder point has been reached, *perpetual* (i.e., continual) monitoring of inventory is required.

Inventory that is intended to meet expected demand is known as **cycle stock**, while inventory that is held to reduce the probability of experiencing a stockout (i.e., running out of stock) due to demand and/or lead time variability is known as **safety stock**.

The goal in ordering is to place an order when the amount of inventory on hand is sufficient to satisfy demand during the time it takes to receive that order (i.e., lead time). There are four determinants of the reorder point quantity:

- The rate of demand (usually based on a forecast)
- The lead time
- The extent of demand and/or lead time variability
- The degree of stockout risk acceptable to management

Reorder point (ROP) When the quantity on hand of an item drops to this amount, the item is reordered.

Cycle stock The amount of inventory needed to meet expected demand.

Safety stock Extra inventory carried to reduce the probability of a stockout due to demand and/or lead time variability.

LO12.11 Describe reorder point models and solve typical problems.

If demand and lead time are both constant, the reorder point is simply

$$\text{ROP} = d \times \text{LT} \quad (12-10)$$

where

d = Demand rate (units per day or week)

LT = Lead time in days or weeks

Note: Demand and lead time must be expressed in the same time units.

EXAMPLE 7

Computing the ROP When Usage and Lead Time Are Constant

excel

mhhe.com/stevenson14e

Tingly takes Two-a-Day vitamins, which are delivered to his home three days after an order is called in. At what point should Tingly reorder?

SOLUTION

Usage = 2 vitamins a day

Lead time = 3 days

ROP = Usage \times Lead time

= 2 vitamins per day \times 3 days = 6 vitamins

Thus, Tingly should reorder when 6 vitamin tablets are left, which is equal to a three-day supply of two vitamins a day.

When variability is present in demand or lead time, it creates the possibility that actual demand will exceed expected (average) demand. Consequently, it becomes desirable to carry additional inventory, called safety stock, to reduce the risk of running out of inventory (a stockout) during lead time. The reorder point then increases by the amount of the safety stock:

$$\text{ROP} = \frac{\text{Expected demand}}{\text{during lead time}} + \text{Safety stock} \quad (12-11)$$

For example, if expected demand during lead time is 100 units, and the desired amount of safety stock is 10 units, the ROP would be 110 units.

Figure 12.12 illustrates how safety stock can reduce the risk of a stockout during lead time (LT). Note that stockout protection is needed only during lead time. If there is a sudden surge at any point during the cycle, that will trigger another order. Once that order is received, the danger of an imminent stockout is negligible.

Because it costs money to hold safety stock, a manager must carefully weigh the cost of carrying safety stock against the reduction in stockout risk it provides. The customer *service level* increases as the risk of stockout decreases. Order cycle **service level** can be defined as the probability that demand will not exceed supply during lead time (i.e., that the amount of stock on hand will be sufficient to meet demand). Hence, a service level of 95 percent implies a probability of 95 percent that demand will not exceed supply during lead time. An equivalent statement that demand will be satisfied in 95 percent of such instances does *not* mean that 95 percent of demand will be satisfied. The risk of a stockout is the complement of service level; a customer service level of 95 percent implies a stockout risk of 5 percent. That is,

$$\text{Service level} = 100 \text{ percent} - \text{Stockout risk}$$

Later, you will see how the order cycle service level relates to the *annual* service level.

Consider for a moment the importance of stockouts. When a stockout occurs, demand cannot be satisfied at that time. In manufacturing operations, stockouts mean that jobs will be delayed and additional costs will be incurred. If the stockout involves parts for an assembly line, or spare parts for a machine or conveyor belt on the line, the line will have to shut down, typically at a very high cost per hour, until parts can be obtained. For service operations,

Service level Probability that demand will not exceed supply during lead time.

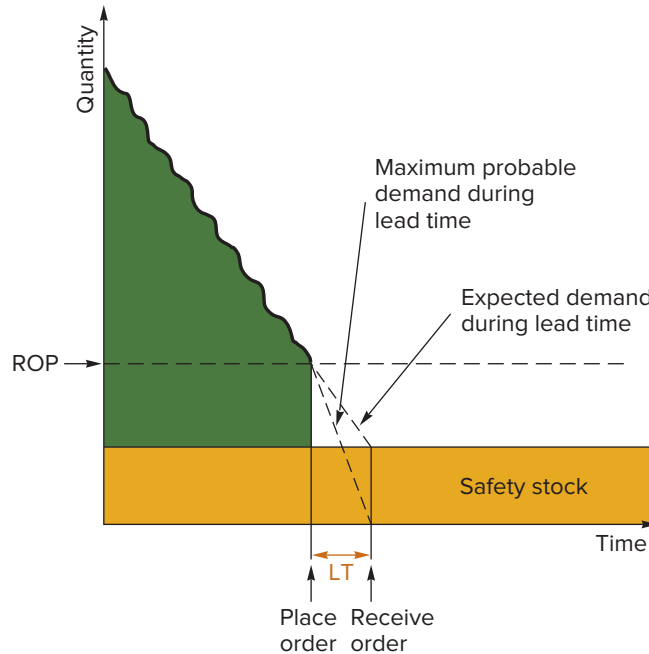
**FIGURE 12.12**

Safety stock reduces the risk of stockout during lead time.

stockouts mean that services cannot be completed on time. Aside from the added cost that results from the time delay, there is not only the matter of customer dissatisfaction but also the fact that schedules will be disrupted, sometimes creating a “domino effect” on following jobs. In the retail sector, stockouts create a competitive *disadvantage* that can result in customer dissatisfaction and, ultimately, the loss of customers.

The amount of safety stock that is appropriate for a given situation depends on the following factors:

- The average demand rate and average lead time
- Demand and lead time variability
- The desired service level

For a given order cycle service level, the greater the variability in either demand rate or lead time, the greater the amount of safety stock that will be needed to achieve that service level. Similarly, for a given amount of variation in demand rate or lead time, achieving an increase in the service level will require increasing the amount of safety stock. Selection of a service level may reflect stockout costs (e.g., lost sales, customer dissatisfaction) or it might simply be a policy variable (e.g., the manager wants to achieve a specified service level for a certain item).

Let us look at several models that can be used in cases when variability is present. The first model can be used if an estimate of expected demand during lead time and its standard deviation are available. The formula is

$$\text{ROP} = \frac{\text{Expected demand during lead time}}{\text{}} + z\sigma_{dLT} \quad (12-12)$$

where

z = Number of standard deviations

σ_{dLT} = The standard deviation of lead time demand

The models generally assume that any variability in demand rate or lead time can be adequately described by a normal distribution. However, this is not a strict requirement; the models provide approximate reorder points even where actual distributions depart from normal.

The value of z (see Figure 12.13) used in a particular instance depends on the stockout risk that the manager is willing to accept. Generally, the smaller the risk the manager is willing to

FIGURE 12.13

The ROP based on a normal distribution of lead time demand

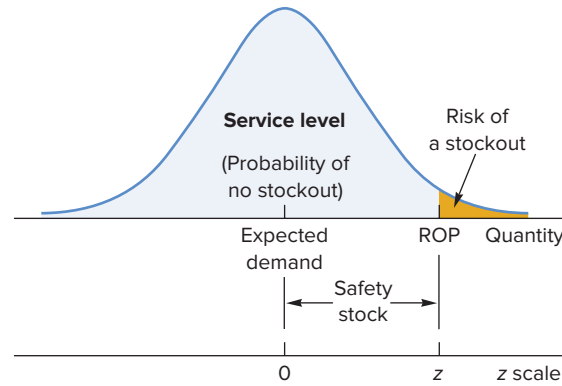

accept, the greater the value of z . Note that the concern is only with the right tail of the normal distribution. Use Appendix B, Table B, to obtain the value of z , given a desired service level for lead time.

EXAMPLE 8**excel**

mhhe.com/stevenson14e

Computing the ROP and Safety Stock When the Mean and Standard Deviation of Lead Time Demand Are Given

Suppose that the manager of a construction supply house determined from historical records that demand for sand during lead time averages 50 tons. In addition, suppose the manager determined that demand during lead time could be described by a normal distribution that has a mean of 50 tons and a standard deviation of 5 tons. Answer the following questions, assuming that the manager is willing to accept a stockout risk of no more than 3 percent.

- What value of z is appropriate?
- How much safety stock should be held?
- What reorder point should be used?

SOLUTION

Expected lead time demand = 50 tons

$$\sigma_{dLT} = 5 \text{ tons}$$

Risk = 3 percent

- From Appendix B, Table B, using a service level of $1 - .03 = .9700$, you obtain a value of $z = +1.88$.
- Safety stock = $z\sigma_{dLT} = 1.88(5) = 9.40$ tons
- ROP = Expected lead time demand + Safety stock = $50 + 9.40 = 59.40$ tons

When data on lead time demand are not readily available, Formula 12–12 cannot be used. Nevertheless, data are generally available on daily or weekly demand, and on the length of lead time. Using those data, a manager can determine whether demand and/or lead time is variable, if variability exists in one or both, and the related standard deviation(s). For those situations, one of the following formulas can be used:

If only demand is variable, then $\sigma_{dLT} = \sigma_d\sqrt{LT}$, and the reorder point is

$$\text{ROP} = \bar{d} \times LT + z\sigma_d\sqrt{LT} \quad (12-13)$$

where

\bar{d} = Average daily or weekly demand

σ_d = Standard deviation of demand in days or weeks

LT = Lead time in days or weeks

If only lead time is variable, then $\sigma_{dLT} = d\sigma_{LT}$, and the reorder point is

$$ROP = d \times \overline{LT} + z\sigma_{LT} \quad (12-14)$$

where

d = Daily or weekly demand

\overline{LT} = Average lead time in days or weeks

σ_{LT} = Standard deviation of lead time in days or weeks

If both demand and lead time are variable, then

$$\sigma_{dLT} = \sqrt{\overline{LT}\sigma_d^2 + \overline{d}^2\sigma_{LT}^2}$$

and the reorder point is

$$ROP = \overline{d} \times \overline{LT} + z\sqrt{\overline{LT}\sigma_d^2 + \overline{d}^2\sigma_{LT}^2} \quad (12-15)$$

Note: Each of these models assumes that demand and lead time are *independent*.

Computing the ROP When Demand Is Variable

A restaurant uses an average of 50 jars of a special sauce each week. Weekly usage of sauce has a standard deviation of 3 jars. The manager is willing to accept no more than a 10 percent risk of stockout during lead time, which is two weeks. Assume the distribution of usage is normal.

- Which of the given formulas is appropriate for this situation? Why?
- Determine the value of z .
- Determine the ROP.

EXAMPLE 9

excel
mhhe.com/stevenson14e

\overline{d} = 50 jars per week

LT = 2 weeks

σ_d = 3 jars per week

Acceptable risk = 10 percent, so service level is .90

SOLUTION

- Because only demand is variable (i.e., has a standard deviation), Formula 12-13 is appropriate.
- From Appendix B, Table B, using a service level of .9000, you obtain $z = +1.28$.
- $ROP = \overline{d} \times LT + z\sigma_d\sqrt{LT} = 50 \times 2 + 1.28(3)\sqrt{2} = 100 + 5.43 = 105.43$
- Because the inventory is discrete units (jars) in this case, we round the amount to 106. (Generally, round up.)

Note that a two-bin ordering system (see p. 508) involves ROP reordering: The quantity in the second bin is equal to the ROP.

The logic of the three formulas for the reorder point may not be immediately obvious. The first part of each formula is the expected demand, which is the product of daily (or weekly) demand and the number of days (or weeks) of lead time. The second part of the formula is z times the standard deviation of lead time demand. For the formula in which only demand is variable, daily (or weekly) demand is assumed to be normally distributed and has the same mean and standard deviation (see Figure 12.14). The standard deviation of demand for the entire lead time is found by summing the *variances* of daily (or weekly) demands, and then finding the square root of that number because, unlike variances, standard deviations are not additive. Hence, if the daily standard deviation is σ_d , the *variance* is σ_d^2 , and if lead time is four days, the variance of lead time demand will equal the sum of the four variances, which is $4\sigma_d^2$. The standard deviation of lead time demand will be the square root of this, which is equal to $2\sigma_d$. In general, this becomes $\sqrt{LT}\sigma_d$ and, hence, the last part of Formula 12-13.

FIGURE 12.14
Lead time demand

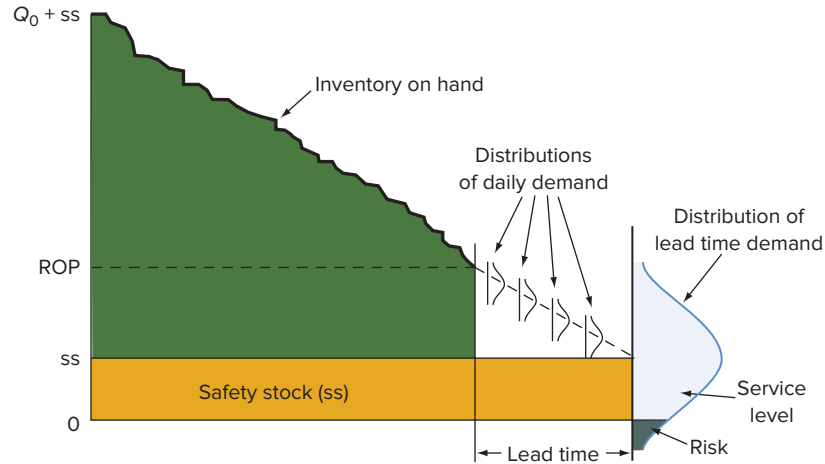

When only lead time is variable, the explanation is much simpler. The standard deviation of lead time demand is equal to the constant daily demand multiplied by the standard deviation of lead time.

When both demand and lead time are variable, the formula appears truly impressive. However, it is merely the result of squaring the standard deviations of the two previous formulas to obtain their variances, summing them, and then taking the square root.

It is sometimes convenient to think of service level in annual terms. One definition of annual service level is the percentage of demand filled directly from inventory. This is also known as the **fill rate**. Thus, if $D = 1,000$, and 990 units were filled directly from inventory (shortages totaling 10 units over the year were recorded), the annual service level (fill rate) would be $990/1,000 = 99$ percent.

Fill rate The percentage of demand filled by the stock on hand.

12.7 HOW MUCH TO ORDER: FIXED-ORDER-INTERVAL MODEL

Fixed-order-interval (FOI) model Orders are placed at fixed time intervals.

LO12.12 Describe situations in which the fixed-order-interval model is appropriate, and solve typical problems.

The **fixed-order-interval (FOI) model** is used when orders must be placed at fixed time intervals (weekly, twice a month, etc.): The timing of orders is set. The question, then, at each order point, is how much to order. Fixed-interval ordering systems are widely used by retail businesses, especially small retail businesses. If demand is variable, the order size will tend to vary from cycle to cycle. This is quite different from an EOQ/ROP approach in which the order size generally remains fixed from cycle to cycle, while the length of the cycle varies (shorter if demand is above average, and longer if demand is below average).

Reasons for Using the Fixed-Order-Interval Model

In some cases, a supplier's policy might encourage orders at fixed intervals. Even when that is not the case, grouping orders for items from the same supplier can produce savings in shipping costs. Furthermore, some situations do not readily lend themselves to continuous monitoring of inventory levels. Many retail operations (e.g., drugstores, small grocery stores) fall into this category. The alternative for them is to use fixed-interval ordering, which requires only periodic checks of inventory levels.

Determining the Amount to Order

If both the demand rate and lead time are constant, the fixed-interval model and the fixed-quantity model function identically. The differences in the two models become apparent only when examined under conditions of variability. Like the ROP model, the fixed-interval model can have variations in demand only, in lead time only, or in both demand and lead time.

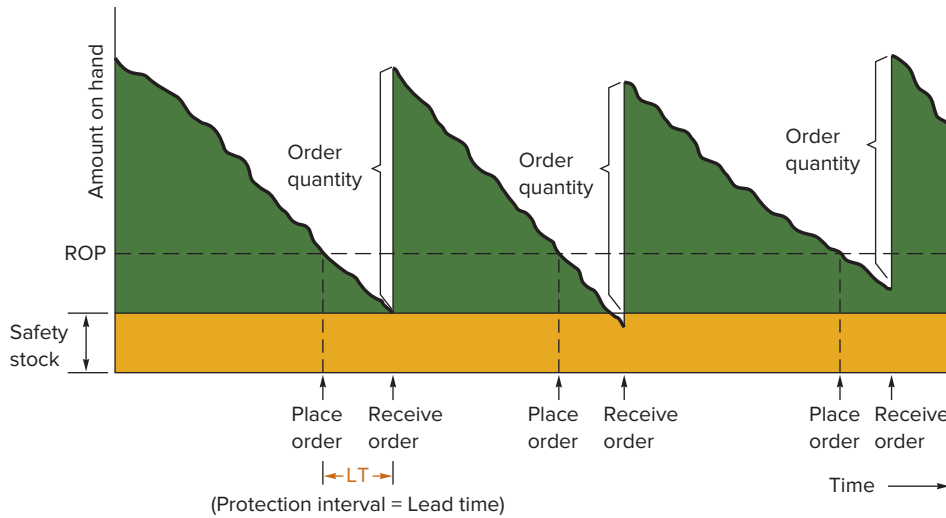
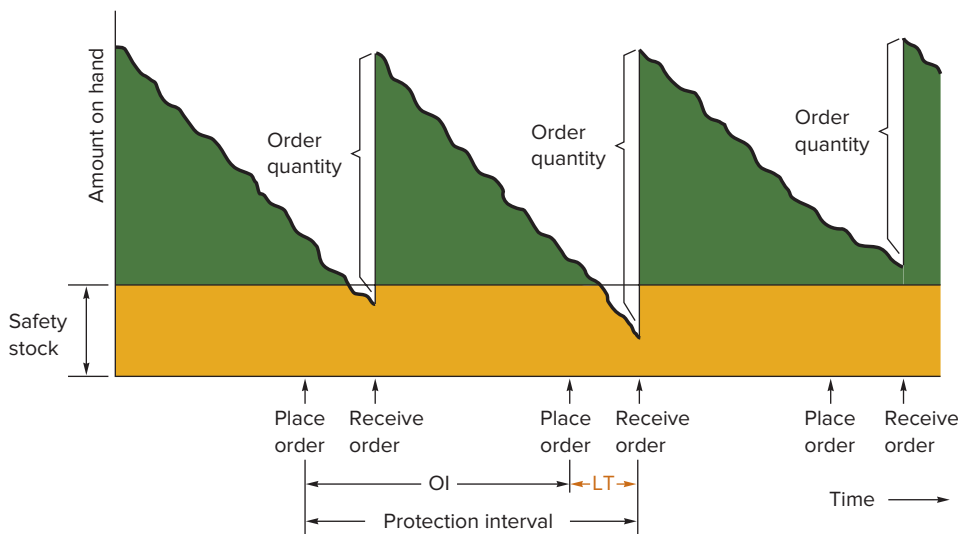

FIGURE 12.15
Comparison of fixed-quantity and fixed-interval ordering

A. Fixed quantity



B. Fixed interval

However, for the sake of simplicity and because it is perhaps the most frequently encountered situation, the discussion here will focus only on *variable demand* and *constant lead time*.

Figure 12.15 provides a comparison of the fixed-quantity and fixed-interval systems. In the fixed-quantity arrangement, orders are triggered by a *quantity* (ROP), whereas in the fixed-interval arrangement, orders are triggered by a *time*. Therefore, the fixed-interval system must have stockout protection for lead time plus the next order cycle, but the fixed-quantity system needs protection only during lead time because additional orders can be placed at any time and will be received shortly (lead time) thereafter. Consequently, there is a greater need for safety stock in the fixed-interval model than in the fixed-quantity model. Note, for example, the large dip into safety stock during the second order cycle with the fixed-interval model.

Both models are sensitive to demand experience just prior to reordering, but in somewhat different ways. In the fixed-quantity model, a higher-than-normal demand causes a *shorter time* between orders, whereas in the fixed-interval model, the result is a *larger order size*. Another difference is that the fixed-quantity model requires close monitoring of inventory levels in order to know *when* the amount on hand has reached the reorder point. The fixed-interval model requires only a periodic review (i.e., physical count) of inventory levels just prior to placing an order to determine how much is needed.

Order size in the fixed-interval model is determined by the following computation:

$$\begin{aligned} \text{Amount to order} &= \frac{\text{Expected demand during protection interval}}{\text{interval}} + \text{Safety stock} - \text{Amount on hand at reorder time} & (12-16) \\ Q &= \bar{d}(\text{OI} + \text{LT}) + z\sigma_d\sqrt{\text{OI} + \text{LT}} - A \end{aligned}$$

where

OI = Order interval (length of time between orders)

A = Amount on hand at reorder time

As in previous models, we assume that demand during the protection interval is normally distributed.

EXAMPLE 10

Computing the Order Quantity for the Fixed-Interval Model

excel

mhhe.com/stevenson14e

Given the following information, determine the amount to order.

\bar{d} = 30 units per day

Desired service level = 99 percent

σ_d = 3 units per day

Amount on hand at reorder time = 71 units

LT = 2 days

OI = 7 days

SOLUTION

$z = 2.33$ for 99 percent service level

$$\text{Amount to order} = \bar{d}(\text{OI} + \text{LT}) + z\sigma_d\sqrt{\text{OI} + \text{LT}} - A$$

$$Q = 30(7 + 2) + 2.33(3)\sqrt{7 + 2} - 71 = 220 \text{ units}$$

An issue related to fixed-interval ordering is the risk of a stockout. A stockout could occur at any point during the order cycle (refer to Figure 12.15). Another point is at the end of the cycle, while waiting to receive the next order.

To find the initial risk of a stockout, assuming no stockout has occurred before ordering, use the ROP formula (12-13), setting ROP equal to the quantity on hand when the order is placed, and solve for z , then obtain the service level for that value of z from Appendix B, Table B, and subtract it from 1.0000 to get the risk of a stockout.

To find the risk of a stockout at the end of the order cycle, use the fixed-interval formula (12-16) and solve for z . Then, obtain the service level for that value of z from Appendix B, Table B, and subtract it from 1.0000 to get the risk of a stockout.

Let's look at an example.

EXAMPLE 11

Computing Stockout Risk for the Fixed-Interval Model

excel

mhhe.com/stevenson14e

Given the following information:

LT = 4 days

OI = 12 days

\bar{d} = 10 units/day

σ_d = 2 units/day

A = 43 units

Q = 171 units

Determine the risk of a stockout at

- The end of the initial lead time.
- The end of the second lead time.

- a. For the risk of stockout for the first lead time, we use Formula 12–13. Substituting the given values, we get $43 = 10 \times 4 + z(2)(2)$. Solving, $z = +.75$. From Appendix B, Table B, the service level is .7734. The risk is $1 - .7734 = .2266$, which is fairly high.
- b. For the risk of a stockout at the end of the second lead time, we use Formula 12–16. Substituting the given values, we get $171 = 10 \times (4 + 12) + z(2)(4) - 43$. Solving, $z = 6.75$. This value is way out in the right tail of the normal distribution, making the service level virtually 100 percent, and, thus, the risk of a stockout at this point is essentially equal to zero.

SOLUTION

Benefits and Disadvantages

The fixed-interval system results in tight control. In addition, when multiple items come from the same supplier, grouping orders can yield savings in ordering, packing, and shipping costs. Moreover, it may be the only practical approach if inventory withdrawals cannot be closely monitored.

On the negative side, the fixed-interval system necessitates a larger amount of safety stock for a given risk of stockout because of the need to protect against shortages during an entire order interval plus lead time (instead of lead time only), and this increases the carrying cost. Also, there are the costs of the periodic reviews.

12.8 THE SINGLE-PERIOD MODEL

The **single-period model** (sometimes referred to as the *newsboy problem*) is used to handle the ordering of perishables (fresh fruits, vegetables, seafood, cut flowers) and items that have a limited useful life (newspapers, magazines, spare parts for specialized equipment). The *period* for spare parts is the life of the equipment, assuming that the parts cannot be used for other equipment. What sets unsold or unused goods apart is that they are not typically carried over from one period to the next, at least not without penalty. Day-old baked goods, for instance, are often sold at reduced prices; leftover seafood may be discarded; and out-of-date magazines may be offered to used book stores at bargain rates. There may even be some cost associated with disposal of leftover goods.

Analysis of single-period situations generally focuses on two costs: shortage and excess. Shortage cost may include a charge for loss of customer goodwill, as well as the opportunity cost of lost sales. Generally, **shortage cost** is simply unrealized profit per unit. That is,

$$C_{\text{shortage}} = C_s = \text{Revenue per unit} - \text{Cost per unit}$$

If a shortage or stockout relates to an item used in production or to a spare part for a machine, then shortage cost refers to the actual cost of lost production.

Excess cost pertains to items left over at the end of the period. In effect, excess cost is the difference between purchase cost and salvage value. That is,

$$C_{\text{excess}} = C_e = \text{Original cost per unit} - \text{Salvage value per unit}$$

If there is cost associated with disposing of excess items, the salvage will be negative and will therefore *increase* the excess cost per unit.

The goal of the single-period model is to identify the order quantity, or stocking level, that will minimize the long-run excess and shortage costs.

There are two general categories of problems that we will consider: those for which demand can be approximated using a continuous distribution (perhaps a theoretical one such as a uniform or normal distribution), and those for which demand can be approximated using a discrete distribution (say, historical frequencies or a theoretical distribution such as the Poisson). The kind of inventory can indicate which type of model might be appropriate.

Single-period model Model for ordering of perishables and other items with limited useful lives.

LO12.13 Describe situations in which the single-period model is appropriate and solve typical problems.

Shortage cost Generally, the unrealized profit per unit (i.e., profit/unit – cost per unit).

Excess cost Difference between purchase cost and salvage value of items left over at the end of a period.

FIGURE 12.16

The optimal stocking level balances unit shortage and excess costs.

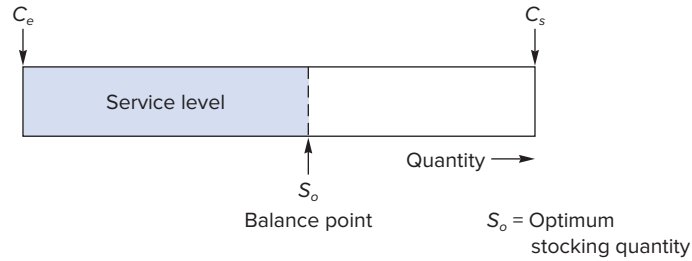

For example, demand for petroleum, liquids, and gases tends to vary over some *continuous scale*, thus lending itself to description by a continuous distribution. Demand for tractors, cars, and computers is expressed in terms of the *number of units* demanded and lends itself to description by a discrete distribution.

Continuous Stocking Levels

The concept of identifying an optimal stocking level is perhaps easiest to visualize when demand is *uniform*. Choosing the stocking level is similar to balancing a seesaw, but instead of a person on each end of the seesaw, we have excess cost per unit (C_e) on one end of the distribution and shortage cost per unit (C_s) on the other. The optimal stocking level is analogous to the fulcrum of the seesaw; the stocking level equalizes the cost weights, as illustrated in Figure 12.16.

The *service level* is the *probability* that demand will not exceed the stocking level, and computation of the service level is the key to determining the optimal stocking level, S_o .

$$\text{Service level} = \frac{C_s}{C_s + C_e} \quad (12-17)$$

where

$$\begin{aligned} C_s &= \text{Shortage cost per unit} \\ C_e &= \text{Excess cost per unit} \end{aligned}$$

If actual demand exceeds S_o , there is a shortage; hence, C_s is on the right end of the distribution. Similarly, if demand is less than S_o , there is an excess, so C_e is on the left end of the distribution. When $C_e = C_s$, the optimal stocking level is halfway between the endpoints of the distribution. If one cost is greater than the other, S_o will be closer to the larger cost.

EXAMPLE 12

eXcel

mhhe.com/stevenson14e

Finding the Optimal Stocking Level and Stockout Risk for the Single-Period Model When Demand Is Uniformly Distributed

Sweet cider is delivered weekly to Cindy's Cider Bar. Demand varies uniformly between 300 liters and 500 liters per week. Cindy pays \$.80 per liter for the cider and charges \$3.20 per liter for it. Unsold cider has no salvage value and cannot be carried over into the next week due to spoilage. Find the optimal stocking level and its stockout risk for that quantity.

SOLUTION

$$\begin{aligned} C_e &= \text{Cost per unit} - \text{Salvage value per unit} \\ &= \$.80 \quad \quad \quad \$0 \\ &= \$.80 \text{ per unit} \\ C_s &= \text{Revenue per unit} - \text{Cost per unit} \\ &= \$3.20 \quad \quad - \$.80 \\ &= \$2.40 \text{ per unit} \end{aligned}$$

$$SL = \frac{C_s}{C_s + C_e} = \frac{\$2.40}{\$2.40 + \$.80} = .75$$

Thus, the optimal stocking level must satisfy demand 75 percent of the time. For the uniform distribution, this will be at a point equal to the minimum demand plus 75 percent of the difference between maximum and minimum demands:

$$S_o = 300 + .75(500 - 300) = 450 \text{ liters}$$

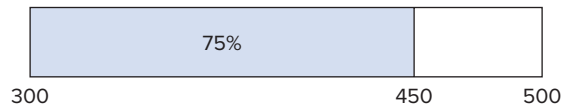

The stockout risk is $1.00 - .75 = .25$.

A similar approach applies when demand is normally distributed.

Finding the Optimal Stocking Level When Demand Is Normally Distributed

Cindy's Cider Bar also sells a blend of cherry juice and apple cider. Demand for the blend is approximately normal, with a mean of 200 liters per week and a standard deviation of 10 liters per week. $C_s = \$2.40$ per liter, and $C_e = \$.80$ per liter. Find the optimal stocking level for the apple-cherry blend.

EXAMPLE 13

excel
mhhe.com/stevenson14e

$$SL = \frac{C_s}{C_s + C_e} = \frac{\$2.40}{\$2.40 + \$.80} = .75$$

This indicates that 75 percent of the area under the normal curve must be to the left of the stocking level. Appendix B, Table B, shows that for a value of z between $+.67$ and $+.68$, use the value of z that has a probability nearest to $.75$. In this case, it is $.67$. The optimal stocking level is $S_o = \text{mean} + z\sigma$. Thus,

$$S_o = 200 \text{ liters} + .67(10 \text{ liters}) = 206.7 \text{ liters}$$

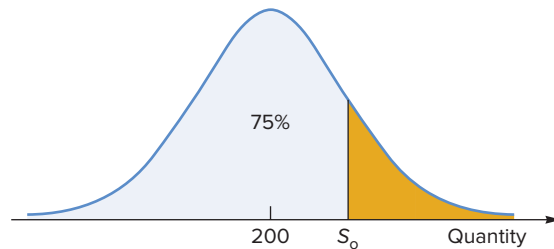

SOLUTION

Discrete Stocking Levels

When stocking levels are discrete rather than continuous, the service level computed using the ratio $C_s/(C_s + C_e)$ usually does not coincide with a feasible stocking level (e.g., the optimal amount may be *between* five and six units). The solution is to stock at the *next higher level* (e.g., six units). In other words, choose the stocking level so that the desired service level is equaled or *exceeded*. Figure 12.17 illustrates this concept.

Example 14 illustrates the use of an empirical distribution.

Finding the Optimal Stocking Level Given an Empirical Frequency Distribution

Historical records on the use of spare parts for several large hydraulic presses are to serve as an estimate of usage for spares of a newly installed press. Stockout costs involve downtime expenses and special ordering costs. These average \$4,200 per unit short.

EXAMPLE 14

excel
mhhe.com/stevenson14e

Spares cost \$800 each, and unused parts have zero salvage. Determine the optimal stocking level.

Spares Used	Relative Frequency	Cumulative Frequency
0	.20	.20
1	.40	.60
2	.30	.90
3	.10	1.00
	<u>1.00</u>	

SOLUTION

$$C_s = \$4,200 \quad C_e = \$800 \quad SL = \frac{C_s}{C_s + C_e} = \frac{\$4,200}{\$4,200 + \$800} = .84$$

The cumulative-frequency column indicates the percentage of time that demand did not exceed (was equal to or less than) some amount. For example, demand does not exceed one spare 60 percent of the time, or two spares 90 percent of the time. Thus, in order to achieve a service level of *at least* 84 percent, it will be necessary to stock two spares (i.e., to go to the next higher stocking level).

The logic behind Formula 12–17 can be seen by solving the problem using a *decision table* approach. Table 12.3 illustrates this approach. The table enumerates the expected cost of each combination of stocking level and demand. For instance, if the stocking level is three, and demand turns out to be zero (see the blue-shaded cell), that would result in an excess of three units, at a cost of \$800 each. The probability of a demand of zero units is .20, so the expected cost of that cell is $.20(3)(\$800) = \480 . Similarly, if no units are stocked and demand is two (see the yellow-shaded cell), the expected cost is the probability of demand being two (i.e., .30) multiplied by two units multiplied by the shortage cost per unit. Thus, the expected cost is $.30(2)(\$4,200) = \$2,520$. For the cases in which the demand and stocking level are the same (the green-shaded cells), supply = demand, so there is neither a shortage nor an excess, and thus the cost is \$0.

The lowest expected cost is \$1,060, which occurs for a stocking level of two units, so two is the optimal stocking level, which agrees with the ratio approach.

FIGURE 12.17

The service level achievement must equal or exceed the ratio $C_s / (C_s + C_e)$.

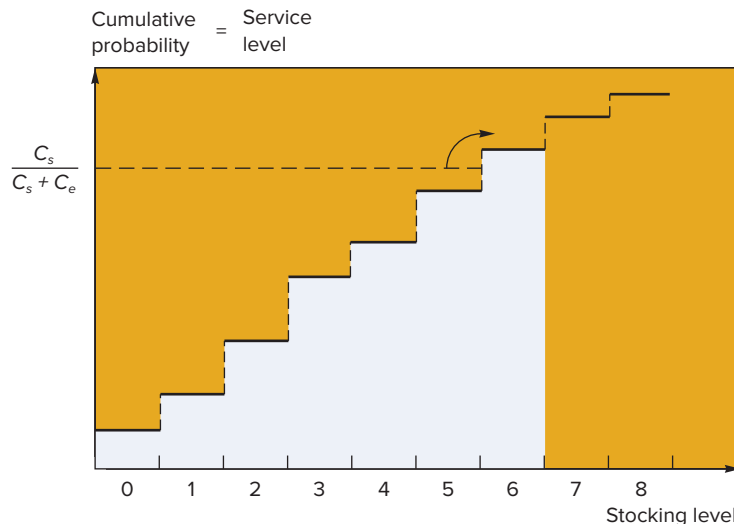

TABLE 12.3 Expected cost for each possible outcome

And the demand probabilities are

If the stocking level is	0 prob. = .20	1 prob. = .40	2 prob. = .30	3 prob. = .10	The expected cost will be
0	S = D \$0	1 unit short .40(1) (\$4,200) = \$1,680	2 units short .30(2) (\$4,200) = \$2,520	3 units short .10(3) (\$4,200) = \$1,260	\$5,460
1	1-unit excess .20(1) (\$800) = \$160	S = D \$0	1 unit short .30(1) (\$4,200) = \$1,260	2 units short .10(2) (\$4,200) = \$840	\$2,260
2	2-unit excess .20(2) (\$800) = \$320	1-unit excess .40(1) (\$800) = \$320	S = D \$0	1 unit short .10(1) (\$4,200) = \$420	\$1,060
3	3-unit excess .20(3) (\$800) = \$480	2-unit excess .40(2) (\$800) = \$640	1-unit excess .30(1) (\$800) = \$240	S = D \$0	\$1,360

Example 15 illustrates how to solve a problem when demand is described by a Poisson distribution.

Finding the Optimal Stocking Level When Demand Has a Poisson Distribution

EXAMPLE 15

Demand for long-stemmed red roses at a small flower shop can be approximated using a Poisson distribution that has a mean of four dozen per day. Profit on the roses is \$3 per dozen. Leftover flowers are marked down and sold the next day at a loss of \$2 per dozen. Assume that all marked-down flowers are sold. What is the optimal stocking level?



$$C_s = \$3 \quad C_e = \$2 \quad SL = \frac{C_s}{C_s + C_e} = \frac{\$3}{\$3 + \$2} = .60$$

SOLUTION

Obtain the cumulative frequencies from the Poisson table (Appendix B, Table C) for a mean of 4.0:

Demand (dozen per day)	Cumulative Frequency
0	.018
1	.092
2	.238
3	.433
4	.629
5	.785
⋮	⋮

Compare the service level to the cumulative frequencies. In order to attain a service level of at least .60, it is necessary to stock four dozen.

One final point about discrete stocking levels: If the computed service level is *exactly* equal to the cumulative probability associated with one of the stocking levels, there are *two* equivalent stocking levels in terms of minimizing long-run cost—the one with equal probability and the next higher one. In the preceding example, if the ratio had been equal to .629, we would be indifferent between stocking four dozen and stocking five dozen roses each day.

12.9 OPERATIONS STRATEGY

Inventories often represent a substantial investment. Improving inventory processes can offer significant benefits in terms of cost reduction and customer satisfaction. Among the areas that have potential are the following:

Record keeping. It is important to have inventory records that are accurate and up-to-date, so that inventory decisions are based on correct information. Estimates of holding, ordering, and setup costs, as well as demand and lead times, should be reviewed periodically and updated when necessary.

Variation reduction. Lead time variations and forecast errors are two key factors that impact inventory management, and variation reduction in these areas can yield significant improvement in inventory management and cost reduction.

Lean operation. Lean systems are demand-driven, which means that goods are pulled through the system to match demand instead of being pushed through without a direct link to demand. Moreover, lean systems feature smaller lot sizes than more traditional systems, based in part on the belief that holding costs are higher than those assigned by traditional systems, and partly as a deliberate effort to reduce ordering and setup costs by simplifying and standardizing necessary activities. With low ordering and setup costs, inventory ordering starts to resemble a “just-in-time” system (see Chapter 14 for more information). An obvious benefit of low inventory is a decrease in average inventory on hand and, hence, lower carrying costs. Other benefits include fewer disruptions of work flow, reduction in space needs, an enhanced ability to spot problems, and increased feasibility to place machines and workers closer together, which allows more opportunities for socialization, communication, and cooperation.

Supply chain management. Working more closely with suppliers to coordinate shipments, reduce lead times, and reduce supply chain inventories can reduce the size and frequency of stockouts while lowering inventory carrying costs. Blanket orders and vendor-managed inventories can reduce transaction costs. Storage costs can sometimes be reduced by using cross-docking, whereby inbound trucks with goods arriving at distributor warehouses from suppliers are directly loaded onto outbound trucks for store or dealer delivery, avoiding warehouse handling and storage costs.

SUMMARY

Inventory management is a core operations management activity. Effective inventory management is often the mark of a well-run organization. Inventory levels must be planned carefully in order to balance the cost of holding inventory and the cost of providing reasonable levels of customer service. Successful inventory management requires a system to keep track of inventory transactions, accurate information about demand and lead times, realistic estimates of certain inventory-related costs, and a priority system for classifying the items in inventory and allocating control efforts. The two basic issues in inventory management are how much to order and when to reorder.

Four classes of models are described: EOQ, ROP, fixed-order-interval, and single-period models. The first three are appropriate if unused items can be carried over into subsequent periods. The single-period model is appropriate when items cannot be carried over. EOQ models address the question of how much to order. The ROP models address the question of when to order and are particularly helpful in dealing with situations that include variations in either demand rate or lead time. ROP models involve service level and safety stock considerations. When the time between orders is fixed, the FOI model is useful for determining the order quantity. The single-period model is used for items that have a “shelf life” of one period. The models presented in this chapter are summarized in Table 12.4.

KEY POINTS

1. All businesses carry inventories, which are goods held for future use or potential future use. Inventory represents money that is tied up in goods or materials.
2. The two basic decisions (issues) in inventory management are how much to order, and when to reorder.
3. Effective inventory decisions depend on having good inventory records, good cost information, and good estimates of demand.

TABLE 12.4 Summary of inventory formulas

Model	Formula	Symbols
Basic EOQ	$Q_0 = \sqrt{\frac{2DS}{H}} \quad (12-2)$ $TC = \frac{Q}{2}H + \frac{D}{Q}S \quad (12-1)$ $\text{Length of order cycle} = \frac{Q}{D} \quad (12-3)$ $\text{Average inventory} = \frac{Q}{2}$	Q_0 = Economic order quantity D = Annual demand S = Order cost per order H = Annual carrying cost per unit Q = Order quantity
Economic production quantity	$Q_p = \sqrt{\frac{2DS}{H}} \sqrt{\frac{p}{p-u}} \quad (12-5)$ $TC = \frac{I_{\max}}{2}H + \frac{D}{Q}S \quad (12-4)$ $\text{Cycle time} = \frac{Q}{u} \quad (12-6)$ $\text{Run time} = \frac{Q}{p} \quad (12-7)$ $I_{\max} = \frac{Q_0}{p}(p-u) \quad (12-8)$ $\text{Average inventory} = \frac{I_{\max}}{2}$	Q_p = Optimal run or order size p = Production or delivery rate u = Usage rate I_{\max} = Maximum inventory level
Quantity discounts	$TC = \frac{Q}{2}H + \frac{D}{Q}S + PD \quad (12-9)$	P = Unit price
Reorder point under: a. Constant demand and lead time b. Variable demand rate c. Variable lead time d. Variable lead time and demand	$ROP = d(LT) \quad (12-10)$ $ROP = \bar{d}LT + z(\sigma_d)\sqrt{LT} \quad (12-13)$ $ROP = \bar{d}\bar{LT} + z(\sigma_{LT})\bar{d} \quad (12-14)$ $ROP = \bar{d}\bar{LT} + z\sqrt{\bar{LT}\sigma_d^2 + \bar{d}^2\sigma_{LT}^2} \quad (12-15)$	ROP = Quantity on hand at reorder point d = Demand rate LT = Lead time \bar{d} = Average demand rate σ_d = Standard deviation of demand rate z = Standard normal deviation \bar{LT} = Average lead time σ_{LT} = Standard deviation of lead time
Fixed interval	$Q = \bar{d}(OI + LT) + z\sigma_d\sqrt{OI + LT} - A \quad (12-16)$	OI = Time between orders A = Amount on hand at order time
Single period	$SL = \frac{C_s}{C_s + C_e} \quad (12-17)$	SL = Service level C_s = Shortage cost per unit C_e = Excess cost per unit

- The decision of how much inventory to have on hand reflects a trade-off, for example, how much money to tie up in inventory versus having it available for other uses. Factors related to the decision include purchase costs, holding costs, ordering costs, shortage and backlog costs, available space to store the inventory, and the return that can be had from other uses of the money.
- As with other areas of operations, variations are present and must be taken into account. Uncertainties can be offset to some degree by holding safety stock, although that adds to the cost of holding inventory.

KEY TERMS

A-B-C approach, 510	inventory, 503	reorder point (ROP), 525
cycle counting, 513	inventory turnover, 507	safety stock, 525, 526
cycle stock, 525	lead time, 509	service level, 526
economic order quantity (EOQ), 514	Little's Law, 506	setup costs, 510
excess cost, 533	ordering costs, 510	shortage cost, 510, 533
fill rate, 530	periodic system, 507	single-period model, 533
fixed-order-interval (FOI) model, 530	perpetual inventory system, 507	stock keeping units (SKUs), 509
holding (carrying) cost, 509	point-of-sale (POS) system, 508	two-bin system, 508
	purchase cost, 509	universal product code (UPC), 508
	quantity discounts, 520	

SOLVED PROBLEMS

Problem 1 *Basic EOQ.* This type of problem can be recognized when annual demand (D), ordering cost (S), and holding or carrying cost per unit (H) are given. Use Formula 12-2 for order quantity, Formula 12-1 for total cost, and D/Q for number of orders a year.

A drone manufacturer uses approximately 32,000 silicon chips annually. The chips are used at a steady rate during the 240 days a year that the plant operates. Annual holding cost is \$3 per chip, and ordering cost is \$120. Determine the following:

- The optimal order quantity
- The number of workdays in an order cycle

Solution $D = 32,000$ chips per year $S = \$120$
 $H = \$3$ per unit per year

$$a. Q_0 = \sqrt{\frac{2DS}{H}} = \sqrt{\frac{2(32,000)120}{3}} = 1,600 \text{ chips}$$

$$b. \frac{Q}{D} = \frac{1,600 \text{ chips}}{32,000 \text{ chips/yr.}} = \frac{1}{20} \text{ year (i.e., } \frac{1}{20} \times 240 \text{ days), or 12 days}$$

Problem 2 *Economic production quantity.* This type of problem can be recognized when a production rate (p) and a usage rate (u) are given in addition to the basic EOQ information. Use Formula 12-5 to compute the optimal run quantity. Production (run) time is Q/p . I_{\max} is $(Q/p)(p - u)$. The time between the end of one run and the start of the next is $(I_{\max})/u - \text{setup time}$.

The Dine Corporation is both a producer and a user of brass couplings. The firm operates 220 days a year and uses the couplings at a steady rate of 50 per day. Couplings can be produced at a rate of 200 per day. Annual storage cost is \$2 per coupling, and machine setup cost is \$70 per run.

- Determine the economic run quantity.
- Approximately how many runs per year will there be?
- Compute the maximum inventory level.
- What is the average inventory on hand?
- Determine the length of the *pure consumption* portion of the cycle.

Solution $D = 50$ units per day \times 220 days per year = 11,000 units per year
 $S = \$70$ per order
 $H = \$2$ per unit per year
 $p = 200$ units per day
 $u = 50$ units per day

$$a. Q_p = \sqrt{\frac{2DS}{H}} \sqrt{\frac{p}{p-u}} = \sqrt{\frac{2(11,000)70}{2}} \sqrt{\frac{200}{200-50}} \approx 1,013 \text{ units}$$

$$b. \text{Number of runs per year: } D/Q_0 = 11,000/1,013 = 10.86, \text{ or approximately 11}$$

- c. $I_{\max} = \frac{Q_p}{p}(p - u) = \frac{1,013}{200}(200 - 50) = 759.75$ or 760 units
- d. Average inventory $= (I_{\max})/2 = 760/2 = 380$ units
- e. $I_{\max}/u = 760/50 = 15.2$ days

Quantity discounts. This type of problem can be recognized when a list showing prices for each quantity range is given along with the basic EOQ information.

- a. If unit holding cost is constant, use these steps to solve the problem:
1. Use Formula 12-2 to find Q .
 2. Locate Q in the price schedule.
 3. Compute the total cost using Formula 12-1 for the quantity range that Q falls in and the total cost for all lower-cost price breaks.
- b. If unit holding cost is a percentage of unit price, use these steps to solve the problem:
1. Beginning with the lowest cost, and using the corresponding H for that cost, compute Q using Formula 12-2. Continue moving up in unit cost until a feasible Q is found.
 2. Locate the feasible Q in the price schedule.
 3. Compute TC using Formula 12-9 for Q and for all lower-cost price breaks. Remember to use the corresponding H for each price.

A small manufacturing firm uses roughly 3,400 pounds of chemical dye a year. Currently, the firm purchases 300 pounds per order and pays \$3 per pound. The supplier has just announced that orders of 1,000 pounds or more will be filled at a price of \$2 per pound. The manufacturing firm incurs a cost of \$100 each time it submits an order and assigns an annual holding cost of 17 percent of the purchase price per pound.

- a. Determine the order size that will minimize the total cost.
- b. If the supplier offered the discount at 1,500 pounds instead of 1,000 pounds, what order size would minimize total cost?

$$D = 3,400 \text{ pounds per year} \quad S = \$100 \text{ per order} \quad H = .17P$$

- a. Compute the EOQ for \$2 per pound. The quantity ranges are as follows.

Range	Unit Price
1 to 999	\$3
1,000 +	\$2

$$Q_{\$2/\text{pound}} = \sqrt{\frac{2DS}{H}} = \sqrt{\frac{2(3,400)(100)}{.17(2)}} = 1,414 \text{ pounds}$$

Because this quantity is feasible at \$2 per pound, it is the optimum.

- b. When the discount is offered at 1,500 pounds, the EOQ for the \$2 per pound range is no longer feasible. Consequently, it becomes necessary to compute the EOQ for \$3 per pound and compare the total cost for that order size with the total cost using the price break quantity (i.e., 1,500).

$$Q_{\$3/\text{pound}} = \sqrt{\frac{2DS}{H}} = \sqrt{\frac{2(3,400)(100)}{.17(3)}} \approx 1,155 \text{ pounds}$$

$$TC = \left(\frac{Q}{2}\right)H + \left(\frac{D}{Q}\right)S + PD$$

$$TC_{1,155} = \left(\frac{1,155}{2}\right) \cdot .17(3) + \left(\frac{3,400}{1,155}\right) 100 + 3(3,400)$$

$$= \$294.53 + \$294.37 + \$10,200 = \$10,789$$

$$TC_{1,500} = \left(\frac{1,500}{2}\right) \cdot .17(2) + \left(\frac{3,400}{1,500}\right) 100 + 2(3,400)$$

$$= \$255 + \$226.67 + \$6,800 = \$7,282$$

Hence, because it would result in a lower total cost, 1,500 is the optimal order size.

Problem 3

Solution

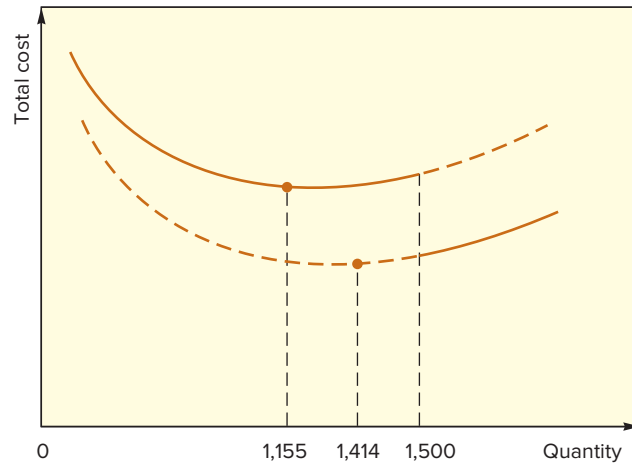

Problem 4 *Reorder point.* This type of problem can be recognized when the demand rate (d), lead time (LT), and desired service level or stockout risk are given. Use these steps to solve this type of problem:

1. Match the choice of formula to the standard deviation(s) that are given in the problem (e.g., if both demand and lead time standard deviations are given, use Formula 12–15 for the ROP).
2. If the problem asks for the amount of safety stock, use the second part of the appropriate ROP formula.
3. If the “expected demand during lead time” and the “standard deviation of lead time demand” are given, use Formula 12–12.

ROP for variable demand and constant lead time. The housekeeping department of a motel uses approximately 400 bars of soap per day. The actual number tends to vary with the number of guests on any given night. Usage can be approximated by a normal distribution that has a mean of 400 and a standard deviation of 9 bars per day. A supply company delivers soap bars with a lead time of three days. If the motel policy is to maintain a stockout risk of 2 percent, what is the minimum number of bars of soap that must be on hand at reorder time, and how much of that amount can be considered safety stock?

Solution

$$\begin{aligned} \bar{d} &= 400 \text{ bars of soap per day} & LT &= 3 \text{ days} \\ \sigma_d &= 9 \text{ bars of soap per day} & \text{Risk} &= 2 \text{ percent, so service level} = 98 \text{ percent} \end{aligned}$$

From Appendix B, Table B, the nearest z value that corresponds to an area under the normal curve to the left of z for 98 percent is +2.05.

$$\begin{aligned} \text{ROP} &= \bar{d}LT + z\sigma_d\sqrt{LT} = 400(3) + 2.05(9)\sqrt{3} \\ &= 1,200 + 31.96, \text{ or approximately } 1,232 \text{ bars of soap} \end{aligned}$$

Safety stock is approximately 32 bars of soap.

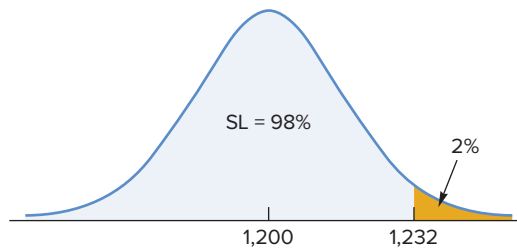

Problem 5 *ROP for constant demand and variable lead time.* The motel in the preceding example uses approximately 600 bottles of water each day, and this tends to be fairly constant. Lead time for water delivery is normally distributed with a mean of six days and a standard deviation of two days. A service level of 90 percent is desired.

- a. Find the ROP.
- b. How many days of supply are on hand at the ROP?

$d = 600$ bottles per day
 SL = 90 percent, so $z = +1.28$ (from Appendix B, Table B2)
 $\bar{L}T = 6$ days
 $\sigma_{LT} = 2$ days

a. $ROP = d\bar{L}T + z(\sigma_{LT})d = 600(6) + 1.28(2)(600)$
 $= 5,136$ bottles of water

b. $\frac{ROP}{d} = \frac{5,136}{600} = 8.56$ days

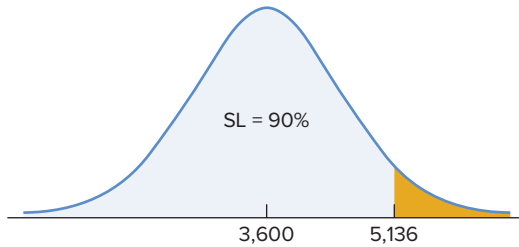

Solution

ROP for variable demand rate and variable lead time. The motel replaces broken glasses at a rate of 25 per day. In the past, this quantity has tended to vary normally and have a standard deviation of three glasses per day. Glasses are ordered from a Cleveland supplier. Lead time is normally distributed with an average of 10 days and a standard deviation of 2 days. What ROP should be used to achieve a service level of 95 percent?

$\bar{d} = 25$ glasses per day $\bar{L}T = 10$ days
 $\sigma_d = 3$ glasses per day $\sigma_{LT} = 2$ days
 SL = 95 percent, so $z = +1.65$ (Appendix B, Table B2)

$ROP = \bar{d}\bar{L}T + z\sqrt{\bar{L}T\sigma_d^2 + \bar{d}^2\sigma_{LT}^2}$
 $= 25(10) + 1.65\sqrt{10(3)^2 + (25)^2(2)^2} = 334$ glasses

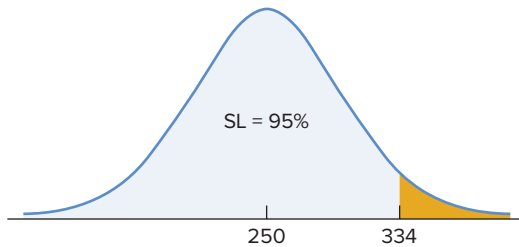

Problem 6

Solution

Fixed-order-interval. This type of problem can be recognized when an order interval is given (e.g., inventory is ordered every 10 days) along with the demand rate, lead time, and quantity on hand at order time. Use Formula 12-16 to find the optimal order size.

A lab orders a number of chemicals from the same supplier every 30 days. Lead time is five days. The assistant manager of the lab must determine how much of one of these chemicals to order. A check of stock revealed that eleven 25-milliliter (ml) jars are on hand. Daily usage of the chemical is approximately normal, with a mean of 15.2 ml per day and a standard deviation of 1.6 ml per day. The desired service level for this chemical is 95 percent.

- a. How many jars of the chemical should be ordered?
- b. What is the average amount of safety stock of the chemical?

$\bar{d} = 15.2$ ml per day OI = 30 days SL = 95 percent requires $z = 1.65$
 $\sigma_d = 1.6$ ml per day LT = 5 days A = 11 jars \times 25 ml per jar = 275 ml

Problem 7

Solution

$$\begin{aligned} \text{a. Amount to order} &= \bar{d}(\text{OI} + \text{LT}) + z\sigma_d\sqrt{\text{OI} + \text{LT}} - A \\ &= 15.2(30 + 5) + 1.65(1.6)\sqrt{30 + 5} - 275 = 272.62 \text{ ml} \end{aligned}$$

Convert this to number of jars:

$$\frac{272.62 \text{ ml}}{25 \text{ ml per jar}} = 10.90 \text{ or } 11 \text{ jars}$$

$$\text{b. Safety stock} = z\sigma_d\sqrt{\text{OI} + \text{LT}} = 1.65(1.6)\sqrt{30 + 5} = 15.62 \text{ ml}$$

Problem 8

Single-period. This type of problem can be recognized when a probability distribution or empirical distribution for demand of a “perishable” item is given along with unit shortage and excess costs, or information that can be used to calculate them. Use the following steps to solve the problem.

1. Compute the optimal service level using Formula 12–17.
2. If the given distribution is uniform or normal, use that to obtain the exact stocking level.
3. If the distribution is Poisson or empirical, SL will fall between two cumulative frequencies. Round up to the higher frequency to find the optimal stocking level. *Note:* If the distribution is empirical, first obtain the cumulative frequencies or probabilities.

A firm that installs cable TV systems uses a certain piece of equipment for which it carries two spare parts as optimal. The parts cost \$500 each and have no salvage value or useful life after one period. Part failures can be modeled by a Poisson distribution with a mean of two failures during the useful life of the equipment. Holding and disposal costs are negligible. Estimate the apparent range of shortage cost.

Solution

$$C_s \text{ is unknown } C_e = \$500$$

The Poisson table (Appendix B, Table C) provides these values for a mean of 2.0:

Number of Failures	Cumulative Probability
0	.135
1	.406
2	.677
3	.857
4	.947
5	.983
⋮	⋮

For the optimal stocking level, the service level must usually be rounded up to a feasible stocking level. Hence, you know that the service level must have been between .406 and .677 in order to make two units the optimal level. By setting the service level equal first to .406 and then to .677, you can establish bounds on the possible range of shortage costs.

$$\frac{C_s}{C_s + \$500} = .406, \text{ so } C_s = .406(\$500 + C_s)$$

Solving, you find $C_s = \$341.75$. Similarly,

$$\frac{C_s}{C_s + \$500} = .677, \text{ so } C_s = .677(\$500 + C_s)$$

Solving, you find $C_s = \$1,047.99$. Hence, the apparent range of shortage cost is \$341.75 to \$1,047.99.

DISCUSSION AND
REVIEW QUESTIONS

1. What are the primary reasons for holding inventory?
2. What are the requirements for effective inventory management?
3. Briefly describe each of the costs associated with inventory.
4. What potential benefits and risks do RFID tags have for inventory management?
5. Why might it be inappropriate to use inventory turnover ratios to compare inventory performance of companies that are in different industries?
6. How can managers use the results of A-B-C classification?
7. a. List the major assumptions of the EOQ model.
b. How would you respond to the criticism that EOQ models tend to provide misleading results because values of D , S , and H are, at best, educated guesses?
8. Explain briefly how a higher carrying cost can result in a decrease in inventory.
9. What is safety stock, and what is its purpose?
10. Under what circumstances would the amount of safety stock held be large? Small? Zero?
11. What is meant by the term *service level*? Generally speaking, how is service level related to the amount of safety stock held?
12. Describe briefly the A-B-C approach to inventory control.
13. The purchasing agent for a company that assembles and sells air-conditioning equipment in a Latin American country noted that the cost of compressors has increased significantly each time they have been reordered. The company uses an EOQ model to determine order size. What are the implications of this price escalation with respect to order size? What factors other than price must be taken into consideration?
14. Explain how a decrease in setup time can lead to a decrease in the average amount of inventory a firm holds, and why that would be beneficial.
15. What is the single-period model, and under what circumstances is it appropriate?
16. Can the optimal stocking level in the single-period model ever be less than expected demand? Explain briefly.
17. What are some ways in which a company can reduce the need for inventories?

1. What trade-offs are involved in each of these aspects of inventory management?
 - a. Buying additional amounts to take advantage of quantity discounts.
 - b. Treating holding cost as a percentage of unit price instead of as a constant amount.
 - c. Conducting cycle counts once a quarter instead of once a year.
2. Who needs to be involved in inventory decisions involving holding costs? Setting inventory levels? Quantity discount purchases?
3. How has technology aided inventory management? How have technological improvements in products such as automobiles and computers impacted inventory decisions?

TAKING STOCK

1. To be competitive, many fast-food chains began to expand their menus to include a wider range of foods. Although contributing to competitiveness, this has added to the complexity of operations, including inventory management. Specifically, in what ways does the expansion of menu offerings create problems for inventory management?
2. As a supermarket manager, how would you go about evaluating the criticalness of an inventory shortage?
3. Sam is at the post office to mail a package. After he pays for mailing the package, the clerk asks if he would like to buy some stamps. Sam pauses to think before he answers. He doesn't have a credit card with him. After paying for the package, he has about \$30 in his pocket. Analyze this from an inventory standpoint. Identify the relevant considerations.
4. Give two examples of unethical conduct involving inventory management and the ethical principle each one violates.

CRITICAL THINKING
EXERCISES

PROBLEMS

1. a. Determine an A-B-C classification for these items:

Item	Unit Cost	Annual Volume (00)
1	\$100	25
2	80	30
3	15	60
4	50	10
5	11	70
6	60	85
7	10	60

- b. Find the EOQ given this information: $D = 4,500$ units/year, $S = \$36$, and $H = \$10$ per unit per year.
 c. Find the economic production quantity given this information.

$D = 18,000$ units/year, $S = \$100$, $H = \$40$ per unit per year, $p = 120$ units per day, and $u = 90$ units/day

2. a. The following table contains figures on the monthly volume and unit costs for a random sample of 16 items from a list of 2,000 inventory items at a health care facility. Develop an A-B-C classification for these items.

Item	Unit Cost	Usage	Item	Unit Cost	Usage
K34	\$10	200	F99	20	60
K35	25	600	D45	10	550
K36	36	150	D48	12	90
M10	16	25	D52	15	110
M20	20	80	D57	40	120
Z45	80	200	N08	30	40
F14	20	300	P05	16	500
F95	30	800	P09	10	30

- b. Given the monthly usages in the following table, classify the items in A, B, and C categories according to dollar usage.

Item	Usage	Unit Cost
4021	90	\$1,400
9402	300	12
4066	30	700
6500	150	20
9280	10	1,020
4050	80	140
6850	2,000	10
3010	400	20
4400	5,000	5

- c. Determine the percentage of items in each category and the annual dollar value for each category for part *b*.
3. A bakery buys flour in 25-pound bags. The bakery uses 1,215 bags a year. Ordering cost is \$10 per order. Annual carrying cost is \$75 per bag.
- Determine the economic order quantity.
 - What is the average number of bags on hand?
 - How many orders per year will there be?
 - Compute the total cost of ordering and carrying flour.
 - If holding costs were to increase by \$9 per year, how much would that affect the minimum total annual cost?
4. A large law firm uses an average of 40 boxes of copier paper a day. The firm operates 260 days a year. Storage and handling costs for the paper are \$30 a year per box, and it costs approximately \$60 to order and receive a shipment of paper.

- a. What order size would minimize the sum of annual ordering and carrying costs?
 - b. Compute the total annual cost using your order size from part *a*.
 - c. Except for rounding, are annual ordering and carrying costs always equal at the EOQ?
 - d. The office manager is currently using an order size of 200 boxes. The partners of the firm expect the office to be managed “in a cost-efficient manner.” Would you recommend that the office manager use the optimal order size instead of 200 boxes? Justify your answer.
5. Garden Variety Flower Shop uses 750 clay pots a month. The pots are purchased at \$2 each. Annual carrying costs per pot are estimated to be 30 percent of cost, and ordering costs are \$20 per order. The manager has been using an order size of 1,500 flower pots.
- a. What additional annual cost is the shop incurring by staying with this order size?
 - b. Other than cost savings, what benefit would using the optimal order quantity yield?
6. A produce distributor uses 800 packing crates a month, which it purchases at a cost of \$10 each. The manager has assigned an annual carrying cost of 35 percent of the purchase price per crate. Ordering costs are \$28. Currently, the manager orders once a month. How much could the firm save annually in ordering and carrying costs by using the EOQ?
7. A manager receives a forecast for next year. Demand is projected to be 600 units for the first half of the year and 900 units for the second half. The monthly holding cost is \$2 per unit, and it costs an estimated \$55 to process an order.
- a. Assuming that monthly demand will be level during each of the six-month periods covered by the forecast (e.g., 100 per month for each of the first six months), determine an order size that will minimize the sum of ordering and carrying costs for each of the six-month periods.
 - b. Why is it important to be able to assume that demand will be level during each six-month period?
 - c. If the vendor is willing to offer a discount of \$10 *per order* for ordering in multiples of 50 units (e.g., 50, 100, 150), would you advise the manager to take advantage of the offer in either period? If so, what order size would you recommend?
8. A food processor uses approximately 27,000 glass jars a month for its fruit juice product. Because of storage limitations, a lot size of 4,000 jars has been used. Monthly holding cost is 18 cents per jar, and reordering cost is \$60 per order. The company operates an average of 20 days a month.
- a. What penalty is the company incurring by its present order size?
 - b. The manager would prefer ordering 10 times each month but would have to justify any change in order size. One possibility is to simplify order processing to reduce the ordering cost. What ordering cost would enable the manager to justify ordering every other day (i.e., 10 times a month)?
9. The Friendly Sausage Factory (FSF) can produce hot dogs at a rate of 5,000 per day. FSF supplies hot dogs to local restaurants at a steady rate of 250 per day. The cost to prepare the equipment for producing hot dogs is \$66. Annual holding costs are 45 cents per hot dog. The factory operates 300 days a year. Find the following:
- a. The optimal run size
 - b. The number of runs per year
 - c. How many days it takes to produce the optimal run quantity
10. A chemical firm produces sodium bisulfate in 100-pound bags. Demand for this product is 20 tons per day. The capacity for producing the product is 50 tons per day. Setup costs \$100, and storage and handling costs are \$5 per ton a year. The firm operates 200 days a year. (*Note:* 1 ton = 2,000 pounds.)
- a. How many bags per run are optimal?
 - b. What would the average inventory be for this lot size?
 - c. Determine the approximate length of a production run, in days.
 - d. About how many runs per year would there be?
 - e. How much could the company save annually if the setup cost could be reduced to \$25 per run?
11. A company is about to begin production of a new product. The manager of the department that will produce one of the components for the product wants to know how often the machine used to produce the item will be available for other work. The machine will produce the item at a rate of 200 units a day. Eighty units will be used daily in assembling the final product. Assembly will take place five days a week, 50 weeks a year. The manager estimates that it will take almost a full day to get the machine ready for a production run, at a cost of \$300. Inventory holding costs will be \$10 a year.

- a. What run quantity should be used to minimize total annual costs?
 - b. How many days does it take to produce the optimal run quantity?
 - c. What is the average amount of inventory?
 - d. If the manager wants to run another job between runs of this item, and needs a minimum of 10 days per cycle for the other work, will there be enough time?
 - e. Given your answer to part *d*, the manager wants to explore options that will allow this other job to be performed using this equipment. Name three options the manager can consider.
 - f. Suppose the manager decides to increase the run size of the new product. How many additional units would be needed to just accommodate the other job? How much will that increase the total annual cost?
12. A company that produces hair dryers buys some of the components, but it makes the heating element, which it can produce at the rate of 800 per day. Hair dryers are assembled daily, 250 days a year, at a rate of 300 per day. Because of the disparity between the production and usage rates, the heating elements are periodically produced in batches of 2,000 units.
- a. Approximately how many *batches* of heating elements are produced annually?
 - b. If production on a batch begins when there is no inventory of heating elements on hand, how much inventory will be on hand *two days later*?
 - c. What is the average inventory of elements, assuming each production cycle begins when there are none on hand?
 - d. The same equipment that is used to make the heating elements could also be used to make a component for another of the firm’s products. That job would require four days, including setup. Setup time for making a batch of the heating elements is a half day. Is there enough time to do this job between production of batches of heating elements? Explain.
13. A mail-order house uses 18,000 boxes a year. Carrying costs are 60 cents per box a year, and ordering costs are \$96. The following price schedule applies. Determine the following:
- a. The optimal order quantity
 - b. The number of orders per year

Number of Boxes	Price per Box
1,000 to 1,999	\$1.25
2,000 to 4,999	1.20
5,000 to 9,999	1.15
10,000 or more	1.10

14. A jewelry firm buys semiprecious stones to make bracelets and rings. The supplier quotes a price of \$8 per stone for quantities of 600 stones or more, \$9 per stone for orders of 400 to 599 stones, and \$10 per stone for lesser quantities. The jewelry firm operates 200 days per year. Usage rate is 25 stones per day, and ordering costs are \$48.
- a. If carrying costs are \$2 per year for each stone, find the order quantity that will minimize total annual cost.
 - b. If annual carrying costs are 30 percent of unit cost, what is the optimal order size?
 - c. If lead time is six working days, at what point should the company reorder?
15. A manufacturer of exercise equipment purchases the pulley section of the equipment from a supplier who lists these prices: less than 1,000, \$5 each; 1,000 to 3,999, \$4.95 each; 4,000 to 5,999, \$4.90 each; and 6,000 or more, \$4.85 each. Ordering costs are \$50, annual carrying costs per unit are 40 percent of purchase cost, and annual usage is 4,900 pulleys. Determine an order quantity that will minimize total cost.
16. A company will begin stocking remote control devices. Expected monthly demand is 800 units. The controllers can be purchased from either supplier A or supplier B. Their price lists are as follows:

SUPPLIER A		SUPPLIER B	
Quantity	Unit Price	Quantity	Unit Price
1–199	\$14.00	1–149	\$14.10
200–499	13.80	150–349	13.90
500+	13.60	350+	13.70

Ordering cost is \$40 and annual holding cost is 25 percent of unit price per unit. Which supplier should be used and what order quantity is optimal if the intent is to minimize total annual costs?

17. A manager just received a new price list from a supplier. It will now cost \$1.00 a box for order quantities of 801 or more boxes, \$1.10 a box for 200 to 800 boxes, and \$1.20 a box for smaller quantities. Ordering cost is \$80 per order and carrying costs are \$10 per box a year. The firm uses 3,600 boxes a year. The manager has suggested a “round number” order size of 800 boxes. The manager’s rationale is that with a U-shaped cost curve that is fairly flat at its minimum, the difference in total annual cost between 800 and 801 units would be small anyway. How would you reply to the manager’s suggestion? What order size would you recommend?
18. A newspaper publisher uses roughly 800 feet of baling wire each day to secure bundles of newspapers while they are being distributed to carriers. The paper is published Monday through Saturday. Lead time is six workdays. What is the appropriate reorder point quantity, given that the company desires a service level of 95 percent, if that stockout risk for various levels of safety stock is as follows: 1,500 feet, .10; 1,800 feet, .05; 2,100 feet, .02; and 2,400 feet, .01?
19. Given this information:
 - Expected demand during lead time = 300 units
 - Standard deviation of lead time demand = 30 units
 Determine each of the following, assuming that lead time demand is distributed normally:
 - a. The ROP that will provide a risk of stockout of 1 percent during lead time.
 - b. The safety stock needed to attain a 1 percent risk of stockout during lead time.
 - c. Would a stockout risk of 2 percent require more or less safety stock than a 1 percent risk? Explain. Would the ROP be larger, smaller, or unaffected if the acceptable risk were 2 percent instead of 1 percent? Explain.
20. Given this information:
 - Lead-time demand = 600 pounds
 - Standard deviation of lead time demand = 52 pounds (Assume normality.)
 - Acceptable stockout risk during lead time = 4 percent
 - a. What amount of safety stock is appropriate?
 - b. When should this item be reordered?
 - c. What risk of stockout would result from a decision not to have any safety stock?
21. Demand for walnut fudge ice cream at the Sweet Cream Dairy can be approximated by a normal distribution with a mean of 21 gallons per week and a standard deviation of 3.5 gallons per week. The new manager desires a service level of 90 percent. Lead time is two days, and the dairy is open seven days a week. (*Hint: Work in terms of weeks.*)
 - a. If an ROP model is used, what ROP would be consistent with the desired service level? How many days of supply are on hand at the ROP, assuming average demand?
 - b. If a fixed-interval model is used instead of an ROP model, what order size would be needed for the 90 percent service level, with an order interval of 10 days and a supply of 8 gallons on hand at the order time? What is the probability of experiencing a stockout before this order arrives?
 - c. Suppose the manager is using the ROP model described in part *a*. One day after placing an order with the supplier, the manager receives a call from the supplier that the order will be delayed because of problems at the supplier’s plant. The supplier promises to have the order there in two days. After hanging up, the manager checks the supply of walnut fudge ice cream and finds that 2 gallons have been sold since the order was placed. Assuming the supplier’s promise is valid, what is the probability that the dairy will run out of this flavor before the shipment arrives?
22. The injection molding department of a company uses an average of 30 gallons of special lubricant a day. The supply of the lubricant is replenished when the amount on hand is 170 gallons. It takes four days for an order to be delivered. Safety stock is 50 gallons, which provides a stockout risk of 9 percent. What amount of safety stock would provide a stockout risk of 3 percent? Assume normality.
23. A company uses 85 circuit boards a day in a manufacturing process. The person who orders the boards follows this rule: Order when the amount on hand drops to 625 boards. Orders are

delivered approximately six days after being placed. The delivery time is normal with a mean of six days and a standard deviation of 1.10 days. What is the probability that the supply of circuit boards will be exhausted before the order is received if boards are reordered when the amount on hand drops to 625 boards?

24. One item a computer store sells is supplied by a vendor who handles only that item. Demand for that item recently changed, and the store manager must determine when to replenish it. The manager wants a probability of at least 96 percent of not having a stockout during lead time. The manager expects demand to average a dozen units a day and have a standard deviation of two units a day. Lead time is variable, averaging four days with a standard deviation of one day. Assume normality and that seasonality is not a factor.
 - a. When should the manager reorder to achieve the desired probability?
 - b. Why might the model not be appropriate if seasonality were present?
25. The manager of a car wash received a revised price list from the vendor who supplies soap, and a promise of a shorter lead time for deliveries. Formerly, the lead time was four days, but now the vendor promises a reduction of 25 percent in that time. Annual usage of soap is 4,500 gallons. The car wash is open 360 days a year. Assume that daily usage is normal, and that it has a standard deviation of 2 gallons per day. The ordering cost is \$30 and annual carrying cost is \$3 a gallon. The revised price list (cost per gallon) is shown in the following table.

Quantity	Unit Price
1–399	\$2.00
400–799	1.70
800 +	1.62

- a. What order quantity is optimal?
 - b. What ROP is appropriate if the acceptable risk of a stockout is 1.5 percent?
26. A small copy center uses five 500-sheet boxes of copy paper a week. Experience suggests that usage can be well approximated by a normal distribution with a mean of five boxes per week and a standard deviation of one-half box per week. Two weeks are required to fill an order for letter-head stationery. Ordering cost is \$2, and annual holding cost is 20 cents per box.
 - a. Determine the economic order quantity, assuming a 52-week year.
 - b. If the copy center reorders when the supply on hand is 12 boxes, compute the risk of a stockout.
 - c. If a fixed interval of seven weeks instead of an ROP is used for reordering, what risk does the copy center incur that it will run out of stationery before this order arrives if it orders 36 boxes when the amount on hand is 12 boxes?
27. Ned’s Natural Foods sells unshelled peanuts by the pound. Historically, Ned has observed that daily demand is normally distributed with a mean of 80 pounds and a standard deviation of 10 pounds. Lead time also appears normally distributed with a mean of eight days and a standard deviation of one day. What ROP would provide a stockout risk of 10 percent during lead time?
28. Regional Supermarket is open 360 days per year. Daily use of cash register tape averages 10 rolls. Usage appears normally distributed with a standard deviation of 2 rolls per day. The cost of ordering tape is \$1, and carrying costs are 40 cents per roll a year. Lead time is 3 days.
 - a. What is the EOQ?
 - b. What ROP will provide a lead time service level of 96 percent?
29. A car dealership uses 1,200 cases of oil a year. Ordering cost is \$40, and annual carrying cost is \$3 per case. The manager wants a service level of 99 percent.
 - a. What is the optimal order quantity?
 - b. What level of safety stock is appropriate if lead time demand is normally distributed with a mean of 80 cases and a standard deviation of 6 cases?
30. Caring Hospital’s dispensary reorders doses of a drug when the supply on hand falls to 18 units. Lead time for resupply is 3 days. Given the typical usage over the last 10 days, what service level is achieved with the hospital’s reorder policy? (*Hint:* Use Formula 12–13.)

Day	1	2	3	4	5	6	7	8	9	10
Units	3	4	7	5	5	6	4	3	4	5

31. A drugstore uses fixed-order cycles for many of the items it stocks. The manager wants a service level of .98. The order interval is 14 days, and lead time is 2 days. Average demand for one item is 40 units per day, and the standard deviation of demand is 3 units per day. Given the on-hand inventory at the reorder time for each order cycle shown in the following table, determine the order quantities for cycles 1, 2, and 3.

Cycle	On Hand
1	42
2	8
3	103

32. A manager must set up inventory ordering systems for two new production items: P34 and P35. P34 can be ordered at any time, but P35 can be ordered only once every 4 weeks. The company operates 50 weeks a year, and the weekly usage rates for both items are normally distributed. The manager has gathered the following information about the items.

	Item P34	Item P35
Average weekly demand	60 units	70 units
Standard deviation	4 units per week	5 units per week
Unit cost	\$15	\$20
Annual holding cost	30%	30%
Ordering cost	\$70	\$30
Lead time	2 weeks	2 weeks
Acceptable stockout risk	2.5%	2.5%

- When should the manager reorder each item?
 - Compute the order quantity for P34.
 - Compute the order quantity for P35 if 110 units are on hand at the time the order is placed.
33. Given the following list of items,
- Classify the items as A, B, or C.
 - Determine the economic order quantity for each item (round to the nearest whole unit).

Item	Estimated Annual Demand	Ordering Cost	Holding Cost (%)	Unit Price
H4-010	20,000	50	20	2.50
H5-201	60,200	60	20	4.00
P6-400	9,800	80	30	28.50
P6-401	14,500	50	30	12.00
P7-100	6,250	50	30	9.00
P9-103	7,500	50	40	22.00
TS-300	21,000	40	25	45.00
TS-400	45,000	40	25	40.00
TS-041	800	40	25	20.00
V1-001	33,100	25	35	4.00

34. Demand for doughnut holes on Saturdays at Don's Doughnut Shoppe is shown in the following table. Determine the optimal number of doughnut holes, in dozens, to stock if labor, materials, and overhead are estimated to be \$3.20 per dozen, doughnut holes are sold for \$4.80 per dozen, and leftover doughnut holes at the end of each day are sold the next day at half price. What is the *resulting* service level?

Demand (dozens)	Relative Frequency	Demand (dozens)	Relative Frequency
19	.01	25	.10
20	.05	26	.11
21	.12	27	.10
22	.18	28	.04
23	.13	29	.02
24	.14		

35. A public utility intends to buy a turbine as part of an expansion plan and must now decide on the number of spare parts to order. One part, no. X135, can be purchased for \$100 each. Carrying and disposal costs are estimated to be 145 percent of the purchase price over the life of the turbine. A stockout would cost roughly \$88,000 due to downtime, ordering, and “special purchase” factors. Historical records based on the performance of similar equipment operating under similar conditions suggest that demand for spare parts will tend to approximate a Poisson distribution with a mean of 3.2 parts for the useful life of the turbine.
- What is the optimal number of spares to order?
 - Carrying no spare parts would be the best strategy for what range of shortage cost?
36. Skinner’s Fish Market buys fresh Boston bluefish daily for \$4.20 per pound and sells it for \$5.70 per pound. At the end of each business day, any remaining bluefish is sold to a producer of cat food for \$2.40 per pound. Daily demand can be approximated by a normal distribution with a mean of 80 pounds and a standard deviation of 10 pounds. What is the optimal stocking level?
37. A small grocery store sells fresh produce, which it obtains from a local farmer. During the strawberry season, demand for fresh strawberries can be reasonably approximated using a normal distribution with a mean of 40 quarts per day and a standard deviation of 6 quarts per day. Excess costs run 35 cents per quart. The grocer orders 49 quarts per day.
- What is the implied cost of shortage per quart?
 - Why might this be a reasonable figure?
38. Demand for devil’s food whipped-cream layer cake at a local pastry shop can be approximated using a Poisson distribution with a mean of six per day. The manager estimates it costs \$9 to prepare each cake. Fresh cakes sell for \$12. Day-old cakes sell for \$9 each. What stocking level is appropriate if one-half of the day-old cakes are sold and the rest thrown out?
39. Burger Prince buys top-grade ground beef for \$1.00 per pound. A large sign over the entrance guarantees that the meat is fresh daily. Any leftover meat is sold to the local high school cafeteria for 80 cents per pound. Four hamburgers can be prepared from each pound of meat. Burgers sell for 60 cents each. Labor, overhead, meat, buns, and condiments cost 50 cents per burger. Demand is normally distributed with a mean of 400 pounds per day and a standard deviation of 50 pounds per day. What daily order quantity is optimal? (*Hint: Shortage cost must be in dollars per pound.*)
40. Demand for rug-cleaning machines at Clyde’s U-Rent-It is shown in the following table. Machines are rented by the day only. Profit on the rug cleaners is \$10 per day. Clyde has four rug-cleaning machines.

Demand	Frequency
0	.30
1	.20
2	.20
3	.15
4	.10
5	.05
	1.00

- Assuming that Clyde’s stocking decision is optimal, what is the implied range of excess cost per machine?
 - Your answer from part *a* has been presented to Clyde, who protests that the amount is too low. Does this suggest an increase or a decrease in the number of rug machines he stocks? Explain.
 - Suppose now that the \$10 mentioned as profit is instead the excess cost per day for each machine and that the shortage cost is unknown. Assuming that the optimal number of machines is four, what is the implied range of shortage cost per machine?
41. A manager is going to purchase new processing equipment and must decide on the number of spare parts to order with the new equipment. The spares cost \$200 each, and any unused spares will have an expected salvage value of \$50 each. The probability of usage can be described by this distribution:

Number	0	1	2	3
Probability	.10	.50	.25	.15

If a part fails and a spare is not available, two days will be needed to obtain a replacement and install it. The cost for idle equipment is \$500 per day. What quantity of spares should be ordered?

- a. Use the ratio method.
 - b. Use the tabular method (see Table 12.3).
42. A Las Vegas supermarket bakery must decide how many wedding cakes to prepare for the upcoming weekend. Cakes cost \$33 each to make, and they sell for \$60 each. Unsold cakes are reduced to half-price on Monday, and typically one-third of those are sold. Any that remain are donated to a nearby senior center. Analysis of recent demand resulted in the following table:

Demand	0	1	2	3
Probability	.15	.35	.30	.20

How many cakes should be prepared to maximize expected profit?

- a. Use the ratio method.
 - b. Use the tabular method (see Table 12.3).
43. Offwego Airlines has a daily flight from Chicago to Las Vegas. On average, 18 ticket holders cancel their reservations, so the company intentionally overbooks the flight. Cancellations can be described by a normal distribution with a mean of 18 passengers and a standard deviation of 4.55 passengers. Profit per passenger is \$99. If a passenger arrives but cannot board due to overbooking, the company policy is to provide a cash payment of \$200. How many tickets should be overbooked to maximize expected profit?

CASE UPD MANUFACTURING

UPD Manufacturing produces a range of health care appliances for hospital as well as for home use. The company has experienced a steady demand for its products, which are highly regarded in the health care field. Recently, the company has undertaken a review of its inventory ordering procedures as part of a larger effort to reduce costs.

One of the company's products is a blood pressure testing kit. UPD manufactures all of the components for the kit in-house except for the digital display unit. The display units are ordered at six-week intervals from the supplier. This ordering system began about five years ago, because the supplier insisted on it. However, that supplier was bought out by another supplier about a year ago, and the six-week ordering requirement is no longer in place. Nonetheless, UPD has continued to use the six-week ordering policy. According to purchasing manager Tom Chambers, "Unless somebody can give me a reason for changing, I'm going to stick with what we've been doing. I don't have time to reinvent the wheel."

Further discussions with Tom revealed a cost of \$32 to order and receive a shipment of display units from the supplier. The company assembles 89 kits a week. Also, information from Sara James, in Accounting, indicated a weekly carrying cost of \$.08 for each display unit.

The supplier has been quite reliable with deliveries; orders are received five working days after they are faxed to the supplier. Tom indicated that as far as he was concerned, lead-time variability is virtually nonexistent.

Questions

1. Would using an order interval other than every six weeks reduce costs? If so, what order interval would be best, and what order size would that involve?
2. Would you recommend changing to the optimal order interval? Explain.



Grill Rite is an old-line company that started out making wooden matches. As that business waned, the company entered the electric barbecue grill market, with five models of grills it sells nationally. For many years, the company maintained a single warehouse from which it supplied its distributors.

The plant where the company produces barbecue sets is located in a small town, and many workers have been with the company for many years. During the transition from wooden matches to barbecue grills, many employees gave up their weekends to help with changing over the plant and learning the new skills they would need, without pay. In fact, Mac Wilson, the company president, can reel off a string of such instances of worker loyalty. He has vowed to never lay off any workers, and to maintain a full employment, steady rate of output. “Yes, I know demand for these babies (barbecue grills) is seasonal, but the inventory boys will just have to deal with it. On an annual basis, our output matches sales.”

Inventory is handled by a system of four warehouses. There is a central warehouse located near the plant that supplies some customers directly, and the three regional warehouses.

The vice president for sales, Julie Berry, is becoming increasingly frustrated with the inventory system that she says “is antiquated and unresponsive.” She points to increasing complaints from regional sales managers about poor customer service, saying customer orders go unfilled or are late, apparently due to shortages at the regional warehouse. Regional warehouse

managers, stung by complaints from sales managers, have responded by increasing their order sizes from the main warehouse, and maintaining larger amounts of safety stock. This has resulted in increased inventory holding costs, but it hasn’t eliminated the problem. Complaints are still coming in from salespeople about shortages and lost sales. According to managers of the regional warehouses, their orders to the main warehouse aren’t being shipped, or when they are, they are smaller quantities than requested. The manager of the main warehouse, Jimmy Joe (“JJ”) Sorely, says his policy is to give preference to “filling direct orders from actual customers, rather than warehouse orders that might simply reflect warehouses trying to replenish their safety stock. And besides, I never know when I’ll get hit with an order from one of the regional warehouses. I guess they think we’ve got an unlimited supply.” Then he adds, “I thought when we added the warehouses, we could just divide our inventory among the warehouses, and everything would be okay.”

When informed of the “actual customers” remark, a regional warehouse manager exclaimed, “We’re their biggest customer!”

Julie Berry also mentioned that on more than one occasion she has found that items that were out of stock at one regional warehouse were in ample supply in at least one other regional warehouse.

Take the position of a consultant called in by president Mac Wilson. What recommendations can you make to alleviate the problems the company is encountering?



SARAH LUBBERS AND CHRIS RUSCHE, GRAND VALLEY STATE UNIVERSITY

Farmers Restaurant is a full-service restaurant offering a variety of breakfast, lunch, and dinner items. Currently, Kristin Davis is the general manager for the Farmers Restaurant located in the Grand Rapids-Wyoming metro area of Michigan. Since becoming manager, Kristin has faced some difficulties with ordering the right amounts of food items for the restaurant. Because of this, there are some weeks the restaurant has a surplus of menu items that are no longer fresh, and must be discarded. At other times, the restaurant has experienced shortages of some items. The fact that inventory accounts for an average cost of 26 percent of the restaurant’s total revenues underscores the importance of managing inventory. Kristin would like to find a way to ensure that she is maintaining the proper amount of inventory. Customer counts at Kristin’s restaurant have been declining recently, so one of

Kristin’s greatest focuses is to keep current customers and attract new customers. She believes that a key aspect of this is having all of the items on the menu in stock.

The restaurant industry is competitive. In the Grand Rapids-Wyoming metro area alone there are over 1,600 restaurants. Some of Farmers Restaurant’s most serious competitors are IHOP, Applebee’s, and Big Boy, all of which are located within 20 miles of the Farmers Restaurant, so customers have many alternatives from which to choose.

Online inventory systems are used to assist restaurant managers in determining on-hand inventory and gauging how well the restaurant is controlling food costs. The fiscal week for Farmers Restaurant starts on Thursday and ends on Wednesday of the following week. Each Wednesday, the manager physically counts the inventory on hand and enters the data into the online inventory system. The computer software system then compares the

on-hand inventory for that week, the amount of food ordered, and the inventory on hand for the end of the previous week with the sales for the current week. By doing so, it is able to determine a total food cost. The manager compares this cost with the benchmark cost to see how well the restaurant has been managing its inventory. This is one of the most important numbers to managers at the Farmers Restaurant because it accounts for approximately 30 percent of total costs in terms of a store's cost structure.

The computer software system also compares the total cost of food on hand with the total amount of sales for that week and computes a percentage of on-hand inventories. As a guideline, the company has set a standard of having between 29 and 36 percent for its on-hand inventory level. The company feels that this level of inventory is an appropriate average to ensure quality food that is fresh and within expiration. Lastly, it is better to keep the inventory at a minimum level to ensure the accuracy and ease of inventory counts.

The Farmers Restaurant that Kristin manages has been running above average in terms of food costs. For this reason, her boss has become concerned with the performance of the ordering system she is using at her restaurant. Kristin has been using her intuition to decide how much product to order, despite the fact that the product order sheets provide a moving average usage of each product. Kristin bases her inventory management on her intuition because she does not understand how to utilize the moving average forecasting technique when placing orders. An additional complication with ordering inventory is that each item is packed in multiple quantities, so she cannot order the exact amount she needs. Her boss requested that she create a more accurate way of ordering food and to report back to him in one month. Kristin is worried that if she cuts inventory levels too low, she will run out of products, which may result in a decrease in customer counts.

After Kristin met with her boss, she began to think about what changes she could make. She knows that inventory has been a weak point for her, but she remembers one of her employees talking about inventory management from one of his college courses. Kristin decides to ask the employee if he would be willing to help her try and come up with a better way for her to order products. Kristin tells him how the ordering system works, shows him the ordering form, and relates the given information.

Suppose you have been asked to work with Kristin to improve inventory ordering.

Questions

1. Describe the importance of inventory management as it relates to the Farmers Restaurant.
2. What ordering system would be best for this situation?
3. Given the following information, provide an example of how much of Farmers Sausage Gravy Mix should be ordered. You are doing the order for Thursday. Also, Kristin would like a service level of 95 percent, and you have found that there is a standard deviation of 3.5 units per week, and a moving average weekly demand of 35 servings. The gravy mix comes in packs of two servings. There are currently three packs in inventory.
4. Given the above information and an on-hand inventory of 12, determine the risk of stockout at the end of the initial lead time and at the end of the second lead time. The lead time is two days and orders are placed once a week.
5. The supplier Kristin uses is located in Ohio. Why might Kristin consider dealing with a nearby supplier instead of the one in Ohio? What reasons might there be for not switching suppliers?



Bruegger's Bagel Bakery makes and sells a variety of bagels, including plain, onion, poppyseed, and cinnamon raisin, as well as assorted flavors of cream cheese. Bagels are the major source of revenue for the company.

The bagel business is a \$3 billion industry. Bagels are very popular with consumers. Not only are they relatively low in fat, they are filling, and they taste good! Investors like the bagel industry because it can be highly profitable: It only costs about \$.10 to make a bagel, and they can be sold for \$.50 each or more. Although some bagel companies have done poorly in recent years, due mainly to poor management, Bruegger's business is booming; it is number one nationally, with over 450 shops that sell bagels, coffee, and bagel sandwiches for takeout or on-premise consumption. Many stores in the Bruegger's chain generate an average of \$800,000 in sales annually.

Production of bagels is done in batches, according to flavor, with each flavor being produced on a daily basis. Production of bagels at Bruegger's begins at a processing plant, where the basic ingredients of flour, water, yeast, and flavorings are combined in a special mixing machine. After the dough has been thoroughly mixed, it is transferred to another machine that shapes the dough into individual bagels. Once the bagels have been formed, they are loaded onto refrigerated trucks for shipping to individual stores. When the bagels reach a store, they are unloaded from the trucks and temporarily stored while they rise. The final two steps of processing involve boiling the bagels in a kettle of water and malt for one minute, and then baking the bagels in an oven for approximately 15 minutes.

The process is depicted in the figure.

Quality is an important feature of a successful business. Customers judge the quality of bagels by their appearance (size, shape, and shine), taste, and consistency. Customers are also sensitive to the service they receive when they make their purchases. Bruegger's devotes careful attention to quality at every stage of operation, from choosing suppliers of ingredients, careful monitoring of ingredients, and keeping equipment in good operating

condition to monitoring output at each step in the process. At the stores, employees are instructed to watch for deformed bagels and to remove them when they find them. (Deformed bagels are returned to a processing plant where they are sliced into bagel chips, packaged, and then taken back to the stores for sale, thereby reducing the scrap rate.) Employees who work in the stores are carefully chosen and then trained so that they are competent to operate the necessary equipment in the stores and to provide the desired level of service to customers.

The company operates with minimal inventories of raw materials and inventories of partially completed bagels at the plant and very little inventory of bagels at the stores. One reason for this is to maintain a high degree of freshness in the final product by continually supplying fresh product to the stores. A second reason is to keep costs down; minimal inventories mean less space is needed for storage.

Questions

1. Bruegger's maintains relatively little inventory at either its plants or its retail stores. List the benefits and risks of this policy.
2. Quality is very important to Bruegger's.
 - a. What features of bagels do customers look at to judge their quality?
 - b. At what points in the production process do workers check bagel quality?
 - c. List the steps in the production process, beginning with purchasing ingredients, and ending with the sale, and state how quality can be positively affected at each step.
3. Which inventory models could be used for ordering the ingredients for bagels? Which model do you think would be most appropriate for deciding how many bagels to make in a given batch?
4. Bruegger's has bagel-making machines at its plants. Another possibility would be to have a bagel-making machine at each store. What advantages does each alternative have?

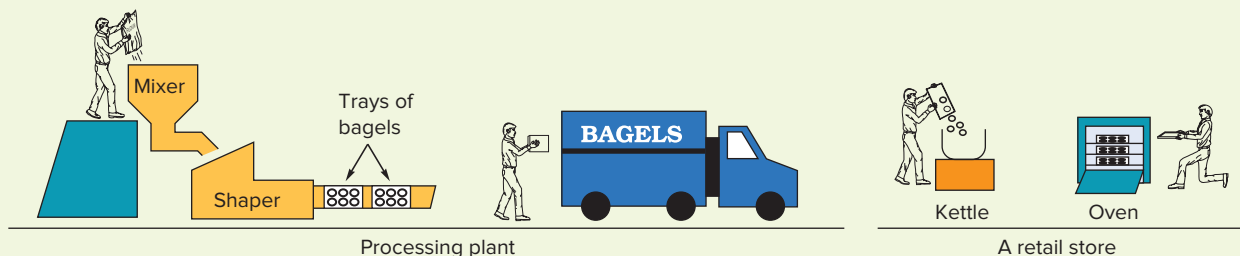



PSC designs and produces a variety of laser bar code scanning devices. The products include handheld bar code readers, high-speed fixed-position industrial scanners, and retail checkout scanners, as well as a full line of accessories, software, and supplies to support its products. Headquartered in Eugene, Oregon, the company has manufacturing facilities in Eugene and Paris, France, with roughly 1,200 employees worldwide.

Products

Bar code scanners are designed for a variety of situations that can involve long-range scanning, reading small bar codes, and performing high-speed scans. They are used extensively in industry, business, and government to manage and control the entire supply chain, which includes suppliers, production, warehousing, distribution, retail sales, and service. Examples of bar code readers include the familiar point-of-sale scanners encountered at supermarkets and other retail stores. They come in a variety of forms, ranging from handheld to built-in models. High-speed, unattended scanners are used for automated material handling and sorting. Typical installations include high-volume distribution centers such as JCPenney's catalog operation and airport baggage handling systems. The company also produces "reader engines" that it supplies to other companies for use in their products. These may be as small as 1.2 cubic inches. One application for an "engine product" is found in lottery ticket validation machines. Use of bar code readers has greatly increased the speed and accuracy of data collection, resulting in increased productivity, improved production and inventory tracking and control, and improved market information.

Operations

Forecasting Forecasting is not a significant activity at PSC due to several factors. There is high standardization of scanner components, which creates stability in usage requirements. Supplier lead times are relatively short, often only a few days. Orders are typically small; 70 percent of all orders are for 10 units or less. There is a fair degree of production flexibility, particularly in terms of product customization. As a result of these factors, the company relies mainly on short-term, moving average forecasts.

Product Design PSC has developed a robust design in many of its products, enabling them to perform effectively under a broad range of operating conditions. For example, many of its handheld scanners can operate at temperatures ranging from -22° F to 120° F, and can withstand drops onto concrete surfaces from heights up to six feet and still function. This has enabled the company to offer warranties ranging from 24 to 36 months, far exceeding the industry standard of 3 to 12 months.

Layout PSC has developed an efficient production layout that consists of assembly lines and work centers. The assembly lines handle standardized production and subassemblies, and the work

centers handle final assembly and customization of products. Assembly lines are U-shaped to facilitate communication among workers. The work centers are designed for production flexibility; they can be reconfigured in about four hours. Work centers are staffed by teams of three to six cross-trained workers who are responsible for an order from start to finish.

The Production Process Production involves a combination of assembly line and batch processing that provides high volume and flexibility to customized individual orders. Because of the high standardization among the internal components of different scanners, many of the subassemblies can be produced on assembly lines. Customization is done primarily on the external portion of various products according to customer specification.

The production process for scanner engines is depicted in the process flowchart shown in the figure. The process begins when an order is received from a customer. The order is then configured according to customer specifications. Next, it is entered into the computer to obtain a bill of materials (BOM), and the order is transmitted to production control so it can be scheduled for production. A "traveler" packet containing product specifications and the BOM is created. It will accompany the order throughout the process.

The traveler is sent to the "kitting" area where standard parts and any customized parts are obtained and placed into a bin ("kit") and then placed in a flow rack until the assigned work center is ready for the job (i.e., a pull system).

The next phase of the process transforms unprogrammed, panelized circuit boards into programmed boards. The boards first pass through a screen printer that uses a stencil to coat the boards with a solder paste. Next, the boards pass through a chip molder that enters values for the smaller, passive components of the circuit board at a rate of 25,000 parts per hour. A second molder enters values for the larger, programmable components at a rate of 7,000 parts per hour. The slower rate for the larger components is offset by the fact that there are fewer of those components. The process ends up being balanced, and no bottlenecks occur.

The programmed boards move by conveyor to a station for visual inspection. Rejects are returned to the chip molder area, and boards that pass are sent through an oven to solidify the solder, making the programming permanent. The circuit boards are then removed from the panels and placed into the kit. The kits are then taken to designated work centers for customization and placement in scanner engines.

Work centers typically have builders, computer operators, and a tester. A builder mounts the laser diodes on the circuit board and passes it to a computer operator who downloads the customer specifications into the microprocessor of the scan engine. The operator also mounts the optical components and adjusts them for the design of the scanner (e.g., long-range scanning). Next, the engine goes to the tester, who checks to make sure that the scanner is capable of reading bar codes and laser characteristics.

(continued)

PSC Inc. Scanner Engine Production Process Flowchart

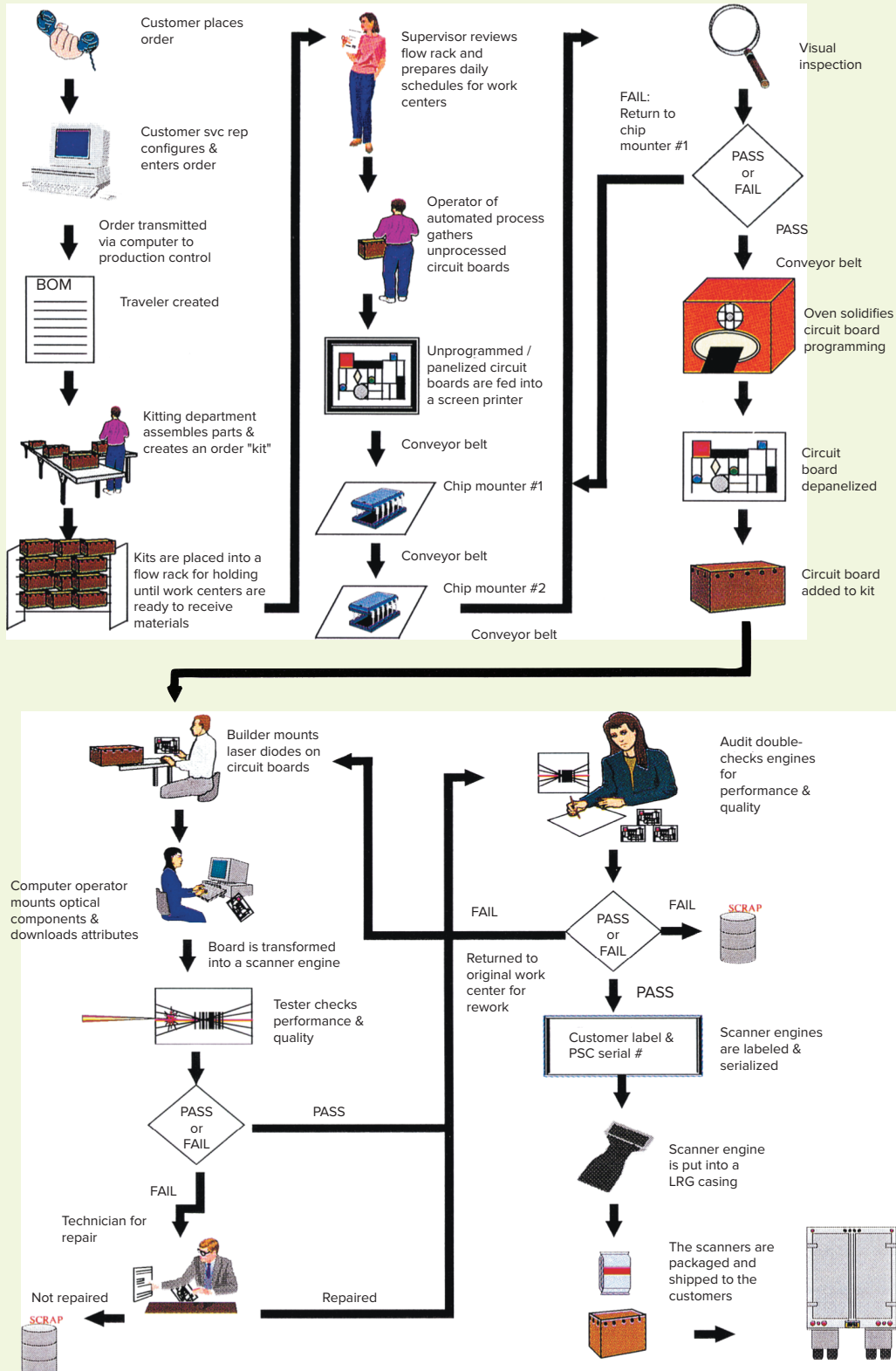

Engines that fail are sent for repair and later retested. If the engine fails a second time, it is either returned for further repair or scrapped. Engines that pass are placed in an electrostatic bag, which protects them from static electricity that could damage the programming.

Engines are then sent to Audit for another check for performance quality.

Engines that pass are incorporated into the final product, a serial number is added, along with a label, and the product is sent to the packing area and then shipped to the customer.

Inventory The company uses a variety of methods for inventory management, and it attempts to minimize the amount of inventory. A computer determines component requirements and generates purchase orders for the components for each order, and then appropriate orders for various components from vendors are prepared. However, the company maintains a stock of standard components that are replenished using a reorder point system. The company has adopted point-of-use replenishment for some areas of operations, having deliveries come directly to the production floor. Finished products are immediately shipped to the customer, which enhances the company's delivery performance and avoids finished goods inventory.

Suppliers Approximately 40 vendors supply parts and materials to PSC, each of which has been subjected to a multiple-step supplier certification program that includes the supplier's completing a self-evaluation questionnaire; an on-site visit of supplier facilities by a team from PSC made up of people from engineering, purchasing, and operations; a probation period; and rating of products using government MIL-STD 105 specifications. Vendor performance is tracked on product quality, delivery, and service.

When an item is removed from inventory, it is scanned into the computer, and this information is transmitted directly to suppliers, along with purchase orders to restock components.

Quality Quality is strongly emphasized at PSC. Employees are trained in quality concepts and the use of quality tools. Training is

incorporated on-the-job so that employees can see the practical applications of what they are learning. Employees are responsible for performing in-process quality checks (quality at the source), and to report any defects they discover to their supervisor. Defects are assigned to one of three categories for problem solving:

- Operator/training error. The supervisor notifies a trainer who then provides appropriate retraining.
- Process/equipment problem. The supervisor notifies the manufacturing engineer who is then responsible for diagnosing the cause and correcting the problem.
- Parts/material problem. The supervisor notifies quality assurance, who then notifies the vendor to correct the problem. Defective parts are either scrapped or returned to the vendor.

Lean Production

PSC strives to operate on lean production principles. In addition to emphasizing high levels of quality, production flexibility, low levels of inventories, and having some deliveries come right to the production floor, its organization structure is fairly flat, and it uses a team approach. Still another feature of lean production is that many of PSC's workers are multiskilled. The company encourages employees to master new skills through a pay-for-skill program, and bases hourly pay rates on the number of skills a worker can perform.

Business Strategy

The company has developed what it believes is a strong strategy for success. Strategic initiatives include anticipating customer demand for miniaturization and the ability to customize products; expanding its proprietary technology; and expanding internationally into Western Europe (now accounts for about 35 percent of sales) and the Pacific Rim (now accounts for about 10 percent of sales). Several plants or groups are ISO certified, which has been important for European sales. The company intends to continue to expand its product lines through acquisition of other companies.

APICS.org

Hopp, Wallace J., and Mark L. Spearman. *Factory Physics*, 3rd ed. New York: Irwin/McGraw-Hill, 2007.

Muller, Max. *Essentials of Inventory Management*, 2nd ed. New York: Amacom Books, 2011.

Piasecki, David J. *Inventory Management Explained: A Focus on Forecasting, Lot Sizing, Safety Stock, and Ordering*. Kenosha, WI: Ops Publishing, 2009.

Pound, Edward, Jeffery H. Bell, and Mark L. Spearman.

Factory Physics for Managers: How Leaders Improve Performance in a Post-lean, Six Sigma World. New York: McGraw-Hill, 2016.

RFID Journal. www.rfidjournal.com

**SELECTED
BIBLIOGRAPHY AND
FURTHER READINGS**

13

CHAPTER

MRP and ERP

LEARNING OBJECTIVES

After completing this chapter, you should be able to:

- LO13.1** Describe the conditions under which MRP is most appropriate.
- LO13.2** Describe the inputs, outputs, and nature of MRP processing.
- LO13.3** Explain how requirements in a master production schedule are translated into material requirements for lower-level items.
- LO13.4** Discuss the benefits and requirements of MRP.
- LO13.5** Describe some of the difficulties users have encountered with MRP.
- LO13.6** Describe MRP II and its benefits.
- LO13.7** Explain how an MRP system is useful in capacity requirements planning.
- LO13.8** Describe ERP, what it provides, and its hidden costs.

CHAPTER OUTLINE

- 13.1 Introduction** 561
- 13.2 An Overview of MRP** 562
- 13.3 MRP Inputs** 563
 - The Master Schedule 563
 - The Bill of Materials 563
 - The Inventory Records 566
- 13.4 MRP Processing** 566
 - Updating the System 572
- 13.5 MRP Outputs** 573
- 13.6 Other Considerations** 574
 - Safety Stock 574
 - Lot Sizing 575
- 13.7 MRP in Services** 576
- 13.8 Benefits and Requirements of MRP** 576
 - Benefits 576
 - Requirements 577
- 13.9 MRP II** 577
 - Closed-Loop MRP 578
- 13.10 Capacity Requirements Planning** 579
 - Distribution Resource Planning for the Supply Chain 580
- 13.11 ERP** 581
 - ERP in Services 587
- 13.12 Operations Strategy** 589
 - Cases:** Promotional Novelties 605
 - DMD Enterprises 606
 - Operations Tour:** Stickley Furniture 606



Mason Trinca for The Washington Post/Getty Images

This chapter describes material requirements planning (MRP) and enterprise resource planning (ERP). MRP is a planning and scheduling technique used for batch production of assembled items. The first portion of the chapter is devoted to MRP. The remainder of the chapter is devoted to ERP, which involves the use of extensive software to integrate record keeping and information sharing throughout an organization and portions of its supply chain.

13.1 INTRODUCTION

A major distinction in the way inventories are managed results from the nature of demand for those items. When demand for items is derived from plans to make certain products, as it is with raw materials, parts, and assemblies used in producing a finished product, those items are said to have **dependent demand**. The parts and materials that go into the production of cars are examples of dependent demand because the total quantity of parts and raw materials needed during any time period depends on the number of cars that will be produced. Conversely, demand for the *finished* cars is independent—a car is not a component of another item.

LO13.1 Describe the conditions under which MRP is most appropriate.

dependent demand Demand for items that are subassemblies or component parts to be used in the production of finished goods.

13.2 AN OVERVIEW OF MRP

material requirements planning (MRP) A methodology that translates master schedule requirements for end items into time-phased requirements for subassemblies, components, and raw materials.

Material requirements planning (MRP) is a methodology used for planning the production of assembled products such as smartphones, automobiles, kitchen tables, and a whole host of other products that are assembled. Some items are produced repetitively, while others are produced in batches. The process begins with a master schedule. The master schedule designates the quantity and completion time of an assembled product, often referred to as the end item. Materials requirements planning then generates a production plan for the end item that indicates the quantities and timing of the subassemblies, component parts, and raw materials required for assembly of that end item. This sequence is depicted in Figure 13.1.

MRP is designed to answer three questions: *What* is needed? *How much* is needed? And *when* is it needed?

The primary inputs of MRP are a bill of materials, which tells the composition of a finished product; a master schedule, which tells how much finished product is desired and when; and an inventory records file, which tells how much inventory is on hand or on order. The planner processes this information to determine the *net* requirements for each period of the planning horizon.

Outputs from the process include planned-order schedules, order releases, changes, performance-control reports, planning reports, and exception reports. These topics are discussed in more detail in subsequent sections. (See Figure 13.2.)

FIGURE 13.1

A material requirements plan indicates quantity and timing details needed to achieve the master schedule

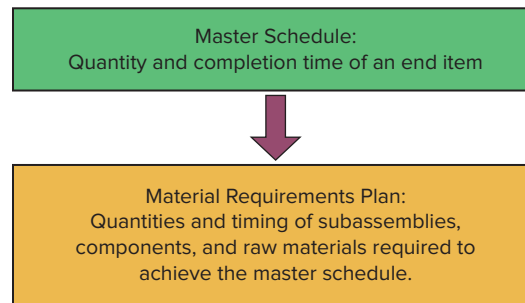
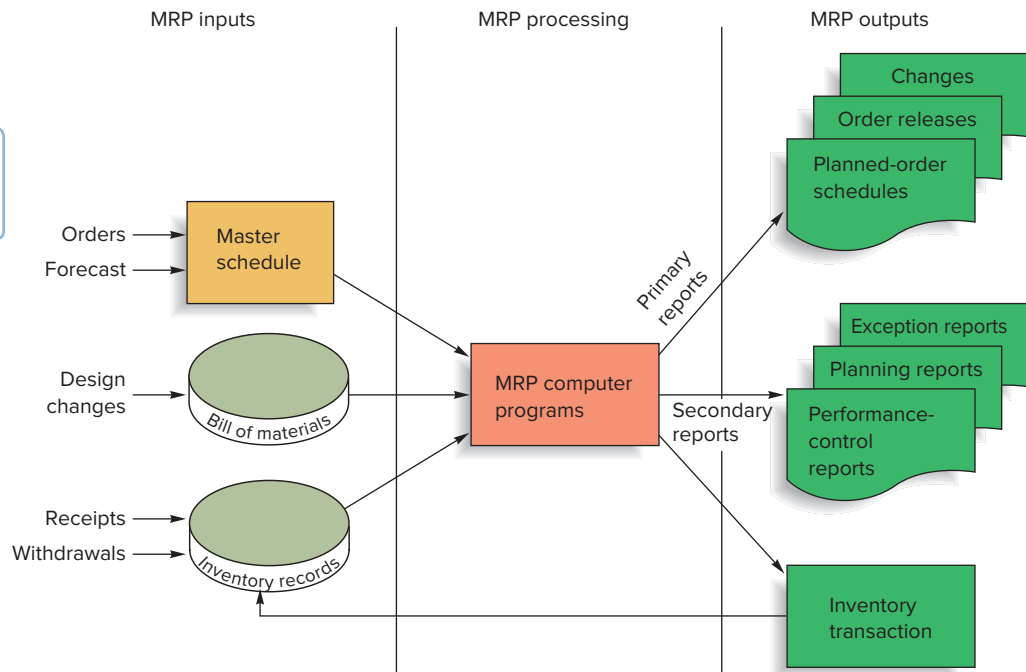

FIGURE 13.2

MRP inputs, processing, and outputs

LO13.2 Describe the inputs, outputs, and nature of MRP processing.



13.3 MRP INPUTS

An MRP system has three major sources of information: a master schedule, a bill-of-materials file, and an inventory records file (see Figure 13.2). Let's consider each of these inputs.

The Master Schedule

The **master schedule**, also referred to as the *master production schedule*, states which end items are to be produced, when they are needed, and in what quantities. (In Chapter 11, Aggregate Planning, there was a discussion of how the master schedule was developed by disaggregating the aggregate plan.) Figure 13.3 illustrates a portion of a master schedule that shows planned output for end item X for the planning horizon. The schedule indicates that 100 units of X will be needed (e.g., for shipments to customers) at the *start* of week 4, and that another 150 units will be needed at the *start* of week 8.

The quantities in a master schedule come from a number of different sources, including customer orders, forecasts, and orders from warehouses to build up seasonal inventories.

The master schedule separates the planning horizon into a series of time periods or time *buckets*, which are often expressed in weeks. However, the time buckets need not be of equal length. In fact, the near-term portion of a master schedule may be in weeks, but later portions may be in months or quarters. Usually, plans for those more distant time periods are more tentative than near-term requirements.

Although a master production schedule has no set time period that it must cover, most managers like to plan far enough into the future so they have some general idea of probable upcoming demands for the near term. It is important, though, that the master schedule cover the *stacked* or **cumulative lead time** necessary to produce the end items. This amounts to the sum of the lead times that sequential phases of the production or assembly process require, as illustrated in Figure 13.4, where a total of nine weeks of lead time is needed from ordering parts and raw materials until final assembly is completed. Note that lead times include move and wait times in addition to setup and run times.

The Bill of Materials

A **bill of materials (BOM)** contains a listing of all of the assemblies, subassemblies, parts, part costs, and raw materials needed to produce *one* unit of a finished product. Thus, each finished product has its own bill of materials.

The listing in the bill of materials is hierarchical; it shows the quantity of each item needed to complete one unit of its parent item. The nature of this aspect of a bill of materials is clear when you consider a **product structure tree**, which provides a visual depiction of the subassemblies and components needed to assemble a product. Figure 13.5 shows an *assembly diagram* for a chair and a simple product structure tree for the chair. The end item (in this case,

master schedule One of three primary inputs in MRP; states which end items are to be produced, when these are needed, and in what quantities.

cumulative lead time The sum of the lead times that sequential phases of a process require, from ordering of parts or raw materials to completion of final assembly.

bill of materials (BOM) One of the three primary inputs of MRP; a listing of all of the raw materials, parts, subassemblies, and assemblies needed to produce one unit of a product.

product structure tree A visual depiction of the requirements in a bill of materials, where all components are listed by levels.

	Week number							
Item: X	1	2	3	4	5	6	7	8
Quantity				100				150

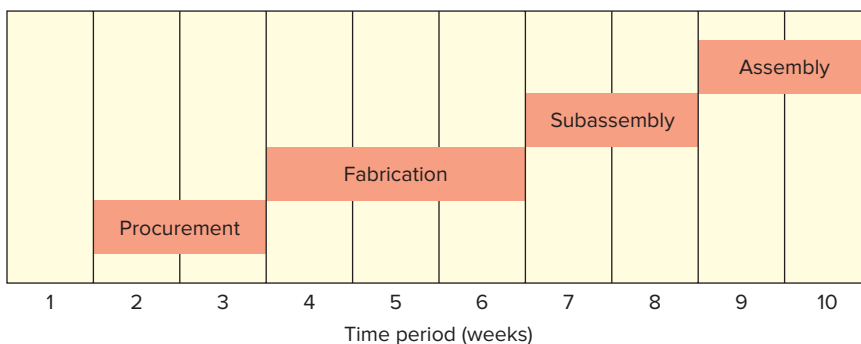

FIGURE 13.3

A master schedule for end item X

FIGURE 13.4

The planning horizon must cover the cumulative lead time.

FIGURE 13.5

Assembly diagram and product structure tree for chair assembly

Level	Bill of Materials	Quantity
0	Chair	1
1	Leg assembly	1
2	Legs	2
2	Cross bar	1
1	Seat	1
1	Back assembly	1
2	Side rails	2
2	Cross bar	1
2	Back supports	3

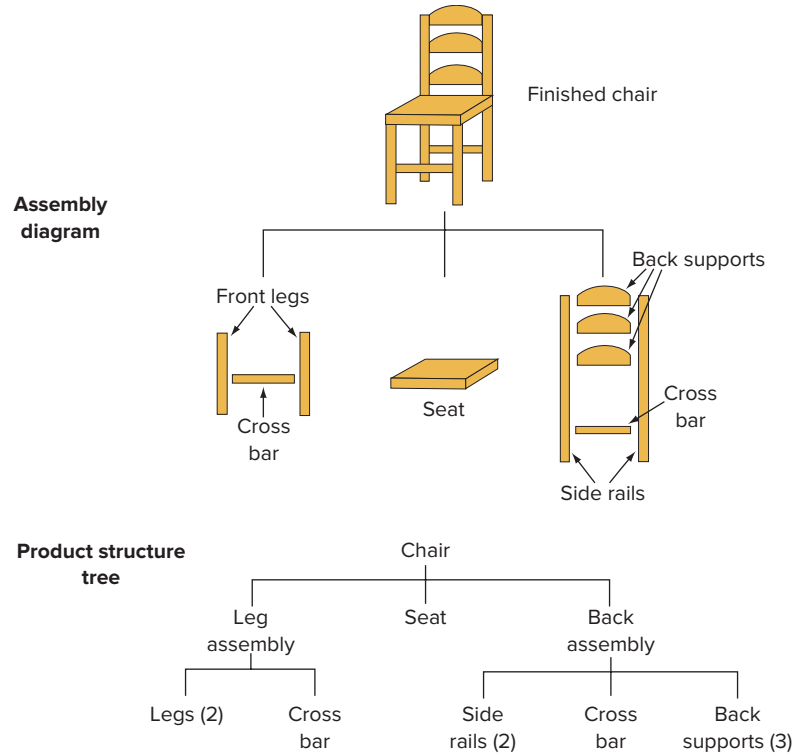
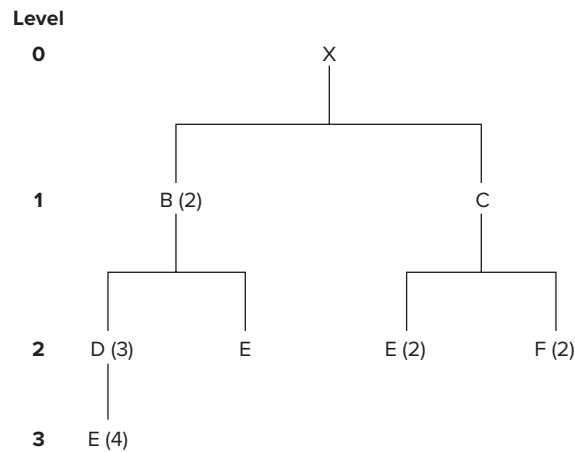

FIGURE 13.6

A product structure tree for end item X



the chair, the finished product) is shown at the top of the tree. Just beneath it are the subassemblies, or major components, that must be put together to make up the end item. Beneath each major component are the necessary lesser components. At each stage moving down the tree are the components (parts, materials) needed to make one unit of the next higher item in the tree.

A product structure tree is useful in illustrating how the bill of materials is used to determine the quantities of each of the ingredients (requirements) needed to obtain a desired number of end items. Items at the lowest levels of a tree might be raw materials or purchased parts, while items at higher levels are typically assemblies or subassemblies. Product-structure trees for items at the lowest levels are the concerns of suppliers.

Let's consider the product structure tree shown in Figure 13.6. End item X is composed of two Bs and one C. Moreover, each B requires three Ds and one E, and each D requires four Es. Similarly, each C is made up of two Es and two Fs. These requirements are listed by level, beginning with 0 for the end item, then 1 for the next level, and so on. The items at each level are components of the next level up and, as in a family tree, are parents of their respective components. Note that the quantities of each item in the product structure tree refer only to the amounts needed to complete the assembly at the next higher level.

Determining How Much of Each Component Will Be Needed for Assembly

EXAMPLE 1



mhhe.com/stevenson14e

Use the information presented in Figure 13.6 to do the following:

- Determine the quantities of B, C, D, E, and F needed to assemble one X.
- Determine the quantities of these components that will be required to assemble 10 Xs, taking into account the quantities on hand (i.e., in inventory) of various components:

Component	On Hand
B	4
C	10
D	8
E	60

SOLUTION

a.

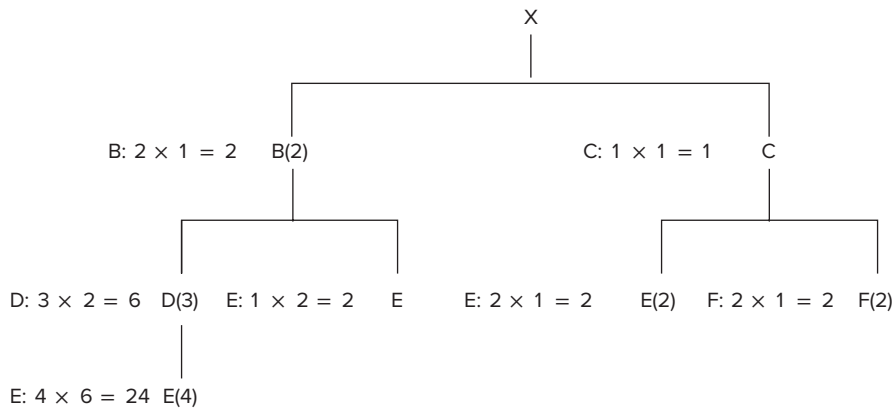

Thus, one X will require

- B: 2
- C: 1
- D: 6
- E: 28 (Note that E occurs in three places, with requirements of $24 + 2 + 2 = 28$.)
- F: 2

b.

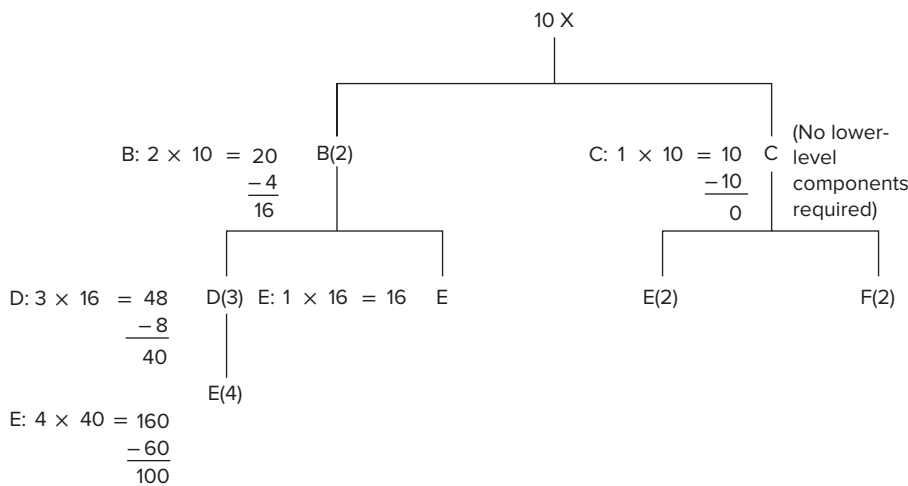

Thus, given the amounts of on-hand inventory, 10 Xs will require

- B: 16
- C: 0
- D: 40
- E: 116
- F: 0

CAD/CAM software can be used not only for design specification but also to prepare parts lists. This screen shows a parts list along with a three-dimensional view of the product.



Andrey Armyagov/Shutterstock

Determining total requirements is usually more complicated than Example 1 might suggest. For one thing, many products have considerably more components. For another, the issue of *timing* is essential (i.e., when must the components be ordered or made) and must be included in the analysis. Finally, for a variety of reasons, some of the components/subassemblies may be on hand (i.e., currently in inventory). Consequently, in determining total requirements, the amounts on hand must be *netted out* (i.e., subtracted from the apparent requirements) to determine the true requirements as illustrated in Example 1.

low-level coding Restructuring the bill of materials so that multiple occurrences of a component all coincide with the lowest level at which the component occurs.

When an MRP system calculates requirements, the computer scans a bill of materials by level. When a component such as E in Figure 13.6 appears on more than one level, **low-level coding** is used so that all occurrences of that component appear on the lowest level at which the component appears. In Figure 13.6, conceptually that would be equivalent to lengthening the vertical line for the two appearances of E at level 2 so that all three occurrences line up at level 3 in the tree.

Note, it is extremely important that the bill of materials accurately reflects the composition of a product, particularly because errors at one level become magnified by the multiplication process used to determine quantity requirements. As obvious as this might seem, many companies find themselves with incorrect bill-of-material records. These make it impossible to effectively determine material requirements; moreover, the task of correcting these records can be complex and time-consuming. Accurate records are a prerequisite for effective MRP.

The Inventory Records

inventory records One of the three primary inputs in MRP; includes information on the status of each item by time period.

Inventory records refer to stored information on the status of each item by time period, called *time buckets*. This includes quantities-on-hand quantities ordered. It also includes other details for each item, such as supplier, lead time, and lot size policy. Changes due to stock receipts and withdrawals, canceled orders, and similar events also are recorded in this file.

Like the bill of materials, inventory records must be accurate. Erroneous information on requirements or lead times can have a detrimental impact on MRP and create turmoil when incorrect quantities are on hand or expected delivery times are not met.

13.4 MRP PROCESSING

LO13.3 Explain how requirements in a master production schedule are translated into material requirements for lower-level items.

MRP processing takes the end item requirements specified by the master schedule and “explodes” them into *time-phased* requirements for assemblies, parts, and raw materials using the bill of materials offset by lead times. You can see the time-phasing of requirements in the assembly time chart in Figure 13.7. For example, raw materials D, F, and I must be ordered at the start of week 2; part C at the start of week 4; and part H at the start of week 5 in order to be available for delivery as planned.

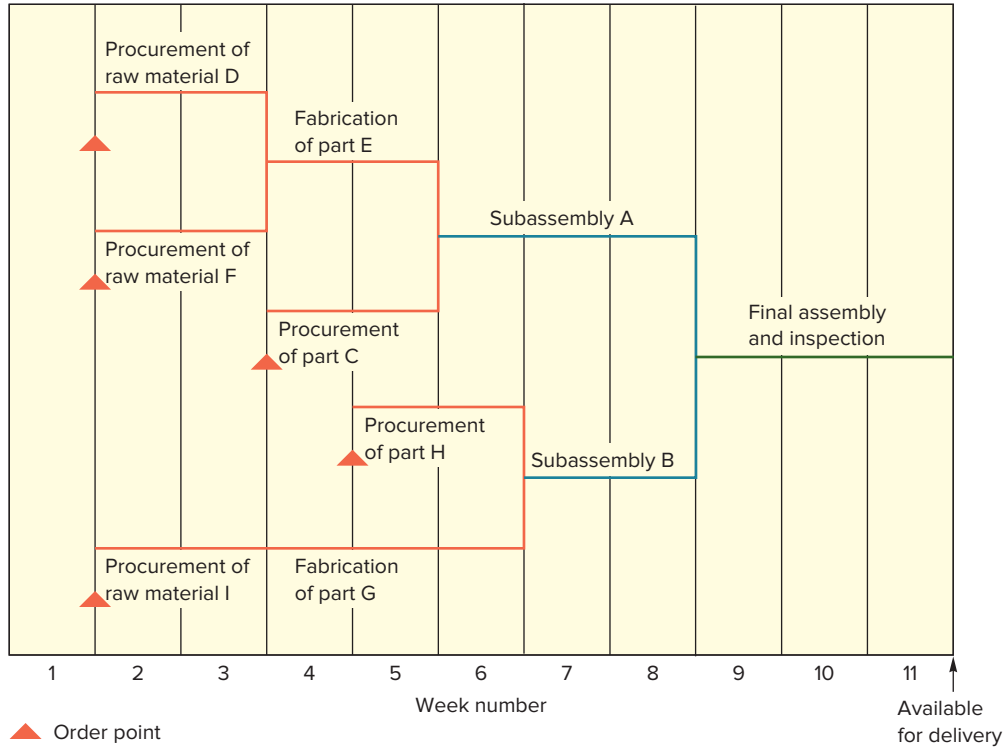

FIGURE 13.7
 Assembly time chart showing material order points needed to meet scheduled availability of the end item

MRP processing combines the time phasing and “explosion” into a sequence of spreadsheet sections, where each section has the following format:

Week Number	Beg. Inv.	1	2	3	4	5	6	7	8
Item:									
Gross requirements									
Scheduled receipts									
Projected on hand									
Net requirements									
Planned-order receipts									
Planned-order releases									

The terms in the spreadsheet are defined as follows.

Gross requirements: The total expected demand for an item or raw material *during* each time period without regard to the amount on hand. For end items, these quantities are shown in the master schedule; for components, these quantities are derived from the planned-order releases of their immediate “parents.”

Scheduled receipts: Open orders (orders that have been placed and are scheduled to arrive from vendors or elsewhere in the pipeline by the *beginning* of a period).

Projected on hand: The expected amount of inventory that will be on hand at the *beginning* of each time period—scheduled receipts plus available inventory from last period. Note that the ending inventory for a period becomes the beginning inventory for the following period.

Net requirements: The actual amount needed in each time period.

gross requirements Total expected demand for an item or raw material in a time period.

scheduled receipts Open orders scheduled to arrive from vendors or elsewhere in the pipeline.

projected on hand Expected amount of inventory that will be on hand at the beginning of each time period.

net requirements The actual amount needed in each time period.

planned-order receipts

Quantity expected to be received by the beginning of the period in which it is shown.

planned-order releases

Planned amount to order in each time period; planned-order receipts offset by lead time.

Planned-order receipts: The quantity expected to be received by the *beginning* of the period in which it is shown. Under lot-for-lot ordering, this quantity will equal net requirements. Under lot-size ordering, this quantity may exceed net requirements.

Any excess is added to available inventory in the *next* time period for simplicity, although in reality it would be available in that period.

Planned-order releases: Indicates a *planned* amount to order in each time period; equals planned-order receipts offset by lead time. This amount generates gross requirements at the next level in the assembly or production chain. In practice, when an order is executed, it is removed from “planned-order releases” and entered under “scheduled receipts.”

The quantities generated by exploding the bill of materials are *gross requirements*; they do not take into account any inventory that is currently on hand or due to be received.

$$\begin{aligned} \text{Project inventory on-hand for current period} &= \text{Planned receipts} \\ &\text{for previous period} - \text{Net requirements for previous period} \\ &+ \text{Scheduled receipts for current period} \end{aligned} \quad (13-1)$$

The materials that a firm must actually acquire to meet the demand generated by the master schedule are the *net material requirements*.

The determination of the net requirements (*netting*) is the core of MRP processing. One accomplishes it by subtracting from gross requirements the sum of inventory on hand and any scheduled receipts.

$$\begin{aligned} \text{Net requirements for current period} &= \text{Gross requirements for current} \\ &\text{period} - \text{Projected on-hand inventory for current period} \end{aligned} \quad (13-2)$$

(Negative results for equations 13–1 or 13–2 should be rounded up to zero.) Projected on-hand inventory includes scheduled receipts, which are executed orders for components that are scheduled to be completed in-house or received from suppliers.

The timing and sizes of orders (i.e., materials ordered from suppliers or work started within the firm) are determined by *planned-order releases*. The timing of the receipts of these quantities is indicated by *planned-order receipts*. Depending on ordering policy, the planned-order releases may be multiples of a specified quantity (e.g., 50 units), or they may be equal to the quantity needed at that time (referred to as *lot-for-lot* ordering). Although there are other possibilities, these two seem to be the most widely used. Example 2 illustrates the difference between these two ordering policies, as well as the general concepts of time-phasing material requirements in MRP.

Development of a material requirements plan is based on the product structure tree diagram. Requirements are determined level by level, beginning with the end item (the top of the tree) and working down the tree, because the timing and quantity of each “parent” item become the basis for determining the timing and quantities of the “children” items directly below it. The children items then become the parent items for the next level, and so on.

EXAMPLE 2

mhhe.com/stevenson14e

Preparing a Material Requirements Plan for Lot-for-Lot Ordering and for Lot-Size Ordering

A firm that produces wood shutters and bookcases has received two orders for shutters: one for 100 shutters and one for 150 shutters. The 100-unit order is due for delivery at the start of week 4 of the current schedule, and the 150-unit order is due for delivery at the start of week 8. Each shutter consists of two frames and four slatted wood sections. The wood sections are made by the firm, and fabrication takes one week. The frames are ordered, and lead time is two weeks. Assembly of the shutters requires one week. There is a scheduled receipt of 70 wood sections in (i.e., at the beginning of) week 1. Determine the size and timing of planned-order releases necessary to meet delivery requirements under each of these conditions:

1. Lot-for-lot ordering (i.e., planned-order release equal to net requirements).
2. Lot-size ordering with a lot size of 320 units for frames and 70 units for wood sections.

SOLUTION

a. Develop a master schedule:

Week number	1	2	3	4	5	6	7	8
Quantity				100				150

b. Develop a product structure tree:

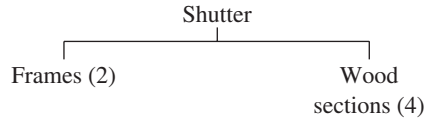

c. Using the master schedule, determine gross requirements for shutters. Next, compute net requirements. Using *lot-for-lot ordering*, determine planned-order receipt quantities and the planned-order release timing to satisfy the master schedule (see Figure 13.8).

FIGURE 13.8 MRP schedule with lot-for-lot ordering

Master schedule for shutters:

Week number	Beg. Inv.	1	2	3	4	5	6	7	8
Quantity					100				150

Shutters: LT = 1 week	Gross requirements				100				150
	Scheduled receipts								
	Projected on hand								
	Net requirements				100				150
	Planned-order receipts					100			150
	Planned-order releases				100			150	

times 2

times 2

Frames: LT = 2 weeks	Gross requirements			200				300	
	Scheduled receipts								
	Projected on hand								
	Net requirements			200				300	
	Planned-order receipts				200			300	
	Planned-order releases		200					300	

times 4

times 4

Wood sections: LT = 1 week	Gross requirements			400				600	
	Scheduled receipts		70						
	Projected on hand		70	70	70				
	Net requirements				330			600	
	Planned-order receipts				330			600	
	Planned-order releases			330				600	

The master schedule calls for 100 shutters to be ready for delivery, and no shutters are projected to be on hand at the start of week 4, so the net requirements are also 100 shutters. Therefore, planned receipts for week 4 equal 100 shutters. Because shutter assembly requires one week, this means a planned-order release at the start of week 3. Using the same logic, 150 shutters must be assembled during week 7 in order to be available for delivery at the start of week 8.

The planned-order release of 100 shutters at the start of week 3 means that 200 frames (gross requirements) must be available at that time. Because none are expected to be on hand, this generates net requirements of 200 frames and necessitates planned receipts of 200 frames by the start of week 3. With a two-week lead time, this means the firm must order 200 frames at the start of week 1. Similarly, the planned-order release of 150 shutters at week 7 generates gross and net requirements of 300 frames for week 7, as well as planned receipts for that time. The two-week lead time means the firm must order frames at the start of week 5.

The planned-order release of 100 shutters at the start of week 3 also generates gross requirements of 400 wood sections at that time. However, because 70 wood sections are

FIGURE 13.9 MRP schedule with lot sizes for components

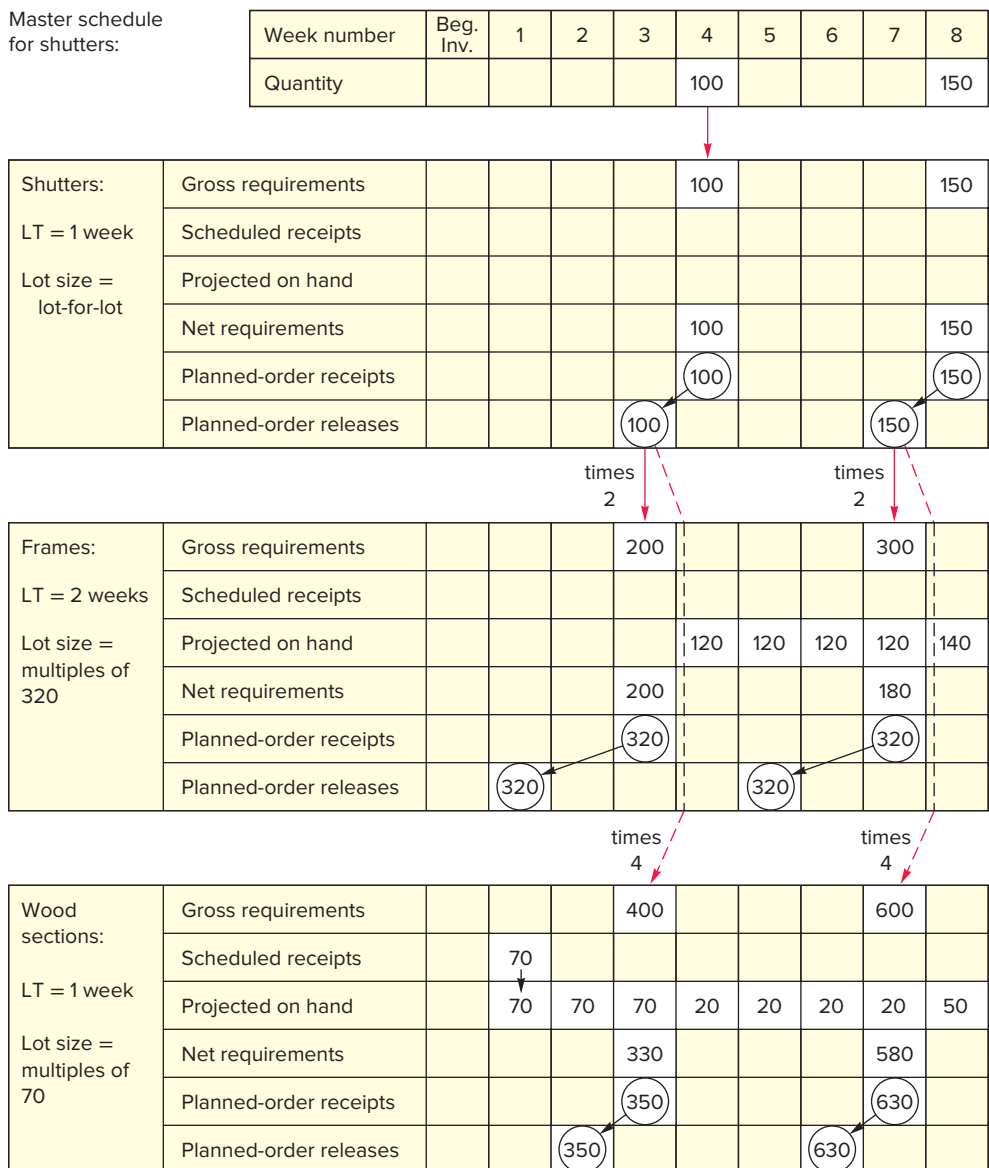

expected to be on hand, net requirements are $400 - 70 = 330$. This means a planned receipt of 330 by the start of week 3. Because fabrication time is one week, the fabrication must start (planned-order release) at the beginning of week 2.

Similarly, the planned-order release of 150 shutters in week 7 generates gross requirements of 600 wood sections at that point. Because no on-hand inventory of wood sections is projected, net requirements are also 600, and planned-order receipt is 600 units. Again, the one-week lead time means 600 sections are scheduled for fabrication at the start of week 6.

d. Under lot-size ordering, the only difference is the possibility that planned receipts will exceed net requirements. The excess is recorded as projected inventory in the following period. For example, in Figure 13.9, the order size for frames is 320 units. Net requirements for week 3 are 200; thus, there is an excess of $320 - 200 = 120$ units, which become projected inventory in the next week. Similarly, net frame requirements of 180 units are 140 less than the 320 order size; again, the excess becomes projected inventory in week 8. The same thing happens with wood sections; an excess of planned receipts in weeks 3 and 7 is added to projected inventory in weeks 4 and 8. Note that the order size must be in multiples of the lot size; for week 3 it is 5 times 70, and for week 7 it is 9 times 70.

MRP provides plans for the end item and each of its subassemblies and components. Conceptually, this amounts to what is depicted in Figure 13.10. Practically speaking, however, the number of components in even a relatively simple product would make the width of the resulting spreadsheet far too wide to handle. Consequently, the plans for the individual components are *stacked*, as illustrated in the preceding example. Because of this, it is important to refer to the product tree in order to track relationships between components.

Example 2 is useful for describing some of the main features of MRP processing, but it understates the enormity of the task of keeping track of material requirements, especially in situations where the same subassemblies, parts, or raw materials are used in a number of different

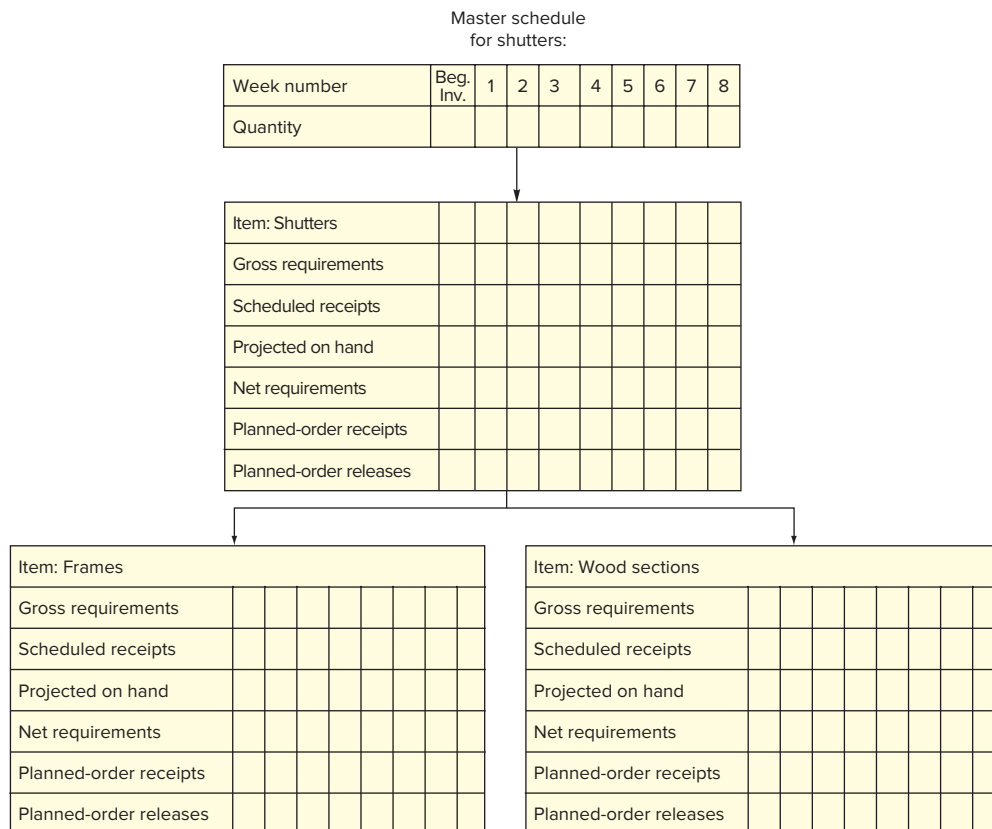
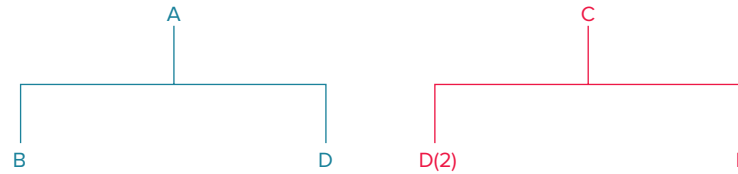

FIGURE 13.10
Net requirements at each level determine gross requirements at the next.

FIGURE 13.11

Two different products have D as a component.



products. Differences in the timing of demands and quantities needed, revisions caused by late deliveries, high scrap rates, and canceled orders all have an impact on processing.

Consider the two product structure trees shown in Figure 13.11. Note that both products have D as a component. Suppose we want to develop a material requirements plan for D given this additional information: There is a beginning inventory of 110 units of D on hand, and all items have lead times of one week. The master schedule calls for 80 units of A in week 4 and 50 units of C in week 5. The plan is shown in Figure 13.12. Note that requirements for B and F are not shown because they are not related to (i.e., neither a “parent” nor a “child” of) D.

pegging The process of identifying the parent items that have generated a given set of material requirements for an item.

The term **pegging** denotes working this process in reverse—that is, identifying the parent items that have generated a given set of material requirements for some item such as D. Although the process may appear simple enough given the product trees and schedules shown in this chapter, when multiple products are involved, the process is more complex. Pegging enables managers to determine which product(s) will be affected if orders are late due to late deliveries, quality problems, or other problems.

The importance of the computer becomes evident when you consider that a typical firm would have not one but many end items for which it needs to develop material requirements plans, each with its own set of components. Inventories on hand and on order, schedules, order releases, and so on must all be updated as changes and rescheduling occur. Without the aid of a computer, the task would be almost hopeless; with the computer, planners can accomplish all of these things with much less difficulty.

Updating the System

A material requirements plan is not a static document. As time passes, some orders will have been completed, other orders will be nearing completion, and new orders will have been entered. In addition, there may have been changes to orders, such as changes in quantity, delays, missed deliveries of parts or raw materials, and so on. Hence, a material requirements plan is a “living” document, one that changes over time. And what we refer to as “Period 1” (i.e., the current period) is continually moving ahead; so what is now Period 2 will soon be Period 1. In a sense, schedules such as these have a *rolling horizon*, which means that plans are updated and revised so they reflect the moving horizon over time.

The two basic systems used to update MRP records are *regenerative* and *net change*. A **regenerative system** is updated periodically; a **net-change system** is continuously updated.

regenerative system

Approach that updates MRP records periodically.

A regenerative system is essentially a batch-type system, which compiles all changes (e.g., new orders, receipts) that occur within the time interval (e.g., day) and periodically updates the system. Using that information, a revised production plan is developed in the same way that the original plan was developed (e.g., exploding the bill of materials, level by level).

net-change system Approach that updates MRP records continuously.

In a net-change system, the production plan is modified to reflect changes as they occur. If some defective purchased parts had to be returned to a vendor, the manager can enter this information into the system as soon as it becomes known. Only the *changes* are exploded through the system, level by level; the entire plan would not be regenerated.

The regenerative system is best suited to fairly stable systems, whereas the net-change system is best suited to systems that have frequent changes. The obvious disadvantage of a regenerative system is the potential amount of lag between the time information becomes available and the time it can be incorporated into the material requirements plan. On the other hand, processing costs are typically less using regenerative systems; changes that occur in a given time period could ultimately cancel each other out, thereby avoiding the need to modify and then remodify the plan. The disadvantages of the net-change system relate to the costs involved in continuously updating the system and the constant state of flux in a system caused

Master schedule

Week number		1	2	3	4	5	6
Quantity of A					80		
Quantity of C						50	

FIGURE 13.12
Material requirements plan for component D

A	LT = 1	Beg. Inv.	1	2	3	4	5	6
Gross requirements						80		
Scheduled receipts								
Projected on hand								
Net requirements						80		
Planned-order receipts						80		
Planned-order releases					80			

C	LT = 1	Beg. Inv.	1	2	3	4	5	6
Gross requirements							50	
Scheduled receipts								
Projected on hand								
Net requirements							50	
Planned-order receipts							50	
Planned-order releases							50	

D	LT = 1	Beg. Inv.	1	2	3	4	5	6
Gross requirements					80	100		
Scheduled receipts								
Projected on hand		110	110	110	110	30		
Net requirements						70		
Planned-order receipts						70		
Planned-order releases					70			

by many small changes. One way around this is to enter minor changes periodically and major changes immediately. The primary advantage of the net-change system is that management can have up-to-date information for planning and control purposes.

13.5 MRP OUTPUTS

MRP systems have the ability to provide management with a fairly broad range of outputs. These are often classified as *primary reports*, which are the main reports, and *secondary reports*, which are optional outputs.

planned orders Schedule indicating the amount and timing of future orders.

order releases Authorization for the execution of planned orders.

changes Revisions of due dates or order quantities, or cancellations of orders.

performance-control reports Evaluation of system operation, including deviations from plans and cost information.

planning reports Data useful for assessing future material requirements.

exception reports Data on any major discrepancies encountered.

Primary Reports. Production and inventory planning and control are part of primary reports. These reports normally include the following:

1. **Planned orders**, a schedule indicating the amount and timing of future orders.
2. **Order releases**, authorizing the execution of planned orders.
3. **Changes** to planned orders, including revisions of due dates or order quantities and cancellations of orders.

Secondary Reports. Performance control, planning, and exceptions belong to secondary reports.

1. **Performance-control reports** evaluate system operation. They aid managers by measuring deviations from plans, including missed deliveries and stockouts, and by providing information that can be used to assess cost performance.
2. **Planning reports** are useful in forecasting future inventory requirements. They include purchase commitments and other data that can be used to assess future material requirements.
3. **Exception reports** call attention to major discrepancies such as late and overdue orders, excessive scrap rates, reporting errors, and requirements for nonexistent parts.

The wide range of outputs generally permits users to tailor MRP to their particular needs.

13.6 OTHER CONSIDERATIONS

Aside from the main details of inputs, outputs, and processing, managers must be knowledgeable about a number of other aspects of MRP. These include the holding of safety stock, lot-sizing choices, and the possible use of MRP for unfinished products.

Safety Stock

Theoretically, inventory systems with dependent demand should not require safety stock below the end item level. This is one of the main advantages of an MRP approach. Supposedly, safety stock is not needed because the manager can project precise usage quantities once the master schedule has been established because demand is not variable. Practically, however, there may be exceptions. For example, a bottleneck process or one with varying scrap rates can cause shortages in downstream operations. Furthermore, shortages may occur if orders are late or fabrication or assembly times are longer than expected. On the surface, these conditions lend themselves to the use of safety stock to maintain smooth operations, but the problem becomes more complicated when dealing with multiechelon items (i.e., multiple-level arenas such as assembled products) because a shortage of *any* component will prevent manufacture of the final assembly. However, a major advantage of MRP is lost by holding safety stock for all lower-level items.

MRP systems deal with these problems in several ways. The manager's first step is to identify activities or operations that are subject to variability and to determine the extent of that variability. When lead times are variable, the concept of safety *time* instead of safety *stock* is often used. This results in scheduling orders for arrival or completion sufficiently ahead of the time they are needed in order to eliminate or substantially reduce the element of chance in waiting for those items. When quantities tend to vary, some safety stock may be called for, but the manager must carefully weigh the need and cost of carrying extra stock. Frequently, managers elect to carry safety stock for end items, which are subject to random demand, and for selected lower-level operations when safety time is not feasible.

It is important in general to make sure that lead times are accurate, particularly when the objective is to have incoming shipments of parts and materials arrive shortly before they are needed. Early arrivals increase on-hand inventory and carrying costs, but late arrivals can raise havoc, possibly delaying all following operations. Knowing this, managers may inflate lead times (i.e., use safety time) and cause early arrivals, defeating the objective of matching the arrival of orders with production schedules.

If safety stock is needed, planned-order release amounts can be increased by the safety stock quantities for the designated components.

Lot Sizing

Determining a lot size to order or to produce is an important issue in inventory management for both independent- and dependent-demand items. This is called lot sizing. For independent-demand items, managers often use economic order sizes and economic production quantities. For dependent-demand systems, however, a much wider variety of plans is used to determine lot sizes, mainly because no single plan has a clear advantage over the others. Some of the most popular plans for lot sizing are described in this section.

A primary goal of inventory management for both independent- and dependent-demand systems is to minimize the sum of ordering cost (or setup cost) and holding cost. With independent demand, that demand is frequently distributed uniformly throughout the planning horizon (e.g., six months, year). In some cases, demand tends to be lumpy and the planning horizon shorter (e.g., three months), so that economic lot sizes are usually much more difficult to identify. Consider the situation depicted in Figure 13.13. Period demands vary from 1 to 80 units, and no demand size repeats over the horizon shown.

Managers can realize economies by grouping orders. This would be the case if the additional cost incurred by holding the extra units until they were used led to a savings in setup or ordering cost. This determination can be very complex at times, for several reasons. First, combining period demands into a single order, particularly for middle-level or end items, has a cascading effect down through the product tree: To achieve this grouping, it becomes necessary to also group items at lower levels in the tree and incorporate their setup and holding costs into the decision. Second, the uneven period demand and the relatively short planning horizon require a continual recalculation and updating of lot sizes. Not surprisingly, the methods used to handle lot sizing range from the complex, which attempt to include all relevant costs, to the very simple, which are easy to use and understand. In certain cases, the simple models seem to approach cost minimization although generalizations are difficult. Let's consider some of these models.

Lot-for-Lot Ordering. Perhaps the simplest of all the methods is lot-for-lot ordering. The order or run size for each period is set equal to demand for that period. Example 2 demonstrated this method. Not only is the order size obvious, it also virtually eliminates holding costs for parts carried over to other periods. Hence, lot-for-lot ordering minimizes investment in inventory. Its two chief drawbacks are that it usually involves many different order sizes and thus cannot take advantage of the economies of fixed order size (e.g., standard containers and other standardized procedures), and it requires a new setup for each production run. If setup costs can be significantly reduced, this method may approximate a minimum-cost lot size.

Economic Order Quantity Model. Sometimes economic order quantity (EOQ) models are used. They can lead to minimum costs if usage is fairly uniform. This is sometimes the case for lower-level items that are common to different parents and for raw materials. However, the more lumpy demand is, the less appropriate such an approach is, because the mismatch in supply and demand results in leftover inventories.

Fixed-Period Ordering. This type of ordering provides coverage for some predetermined number of periods (e.g., two or three). In some instances, the span is simply arbitrary; in other cases, a review of historical demand patterns may lead to a more rational designation of a fixed period length. A simple rule is: Order to cover a two-period interval. The rule can be

	Period				
	1	2	3	4	5
Demand	70	50	1	80	4
Cumulative demand	70	120	121	201	205

FIGURE 13.13
Demand for part K

modified when common sense suggests a better way. For example, take a look at the demands shown in Figure 13.13. Using a two-period rule, an order size of 120 units would cover the first two periods. The next two periods would be covered by an order size of 81 units. However, the demands in periods 3 and 5 are so small, it would make sense to combine them both with the 80 units and order 85 units.

Other Models. There are other models, such as the part-period model and the Wagner-Whitin model, which are used for lot sizing, but these are beyond the scope of this book.

13.7 MRP IN SERVICES

MRP has applications in services, as well as in manufacturing. These applications may involve material goods that form a part of the product–service package, or they may involve mainly service components. Service might involve reconfiguring a workplace or modifying software that controls equipment to handle different processing requirements.

An example of a product–service package is a food catering service, particularly in instances that require preparing and serving meals for large numbers of people. To estimate the quantities and costs of an order, the food manager would have to determine the quantities of the ingredients for each recipe on the menu (i.e., a bill of materials), which would then be combined with the number of each meal to be prepared to obtain a material requirements plan for the event.

Similar examples occur for renovations, such as motel rooms, where there will be multiple repetitions of activities and related materials that must be “exploded” into their components for purposes of cost estimation and scheduling.

13.8 BENEFITS AND REQUIREMENTS OF MRP

LO13.4 Discuss the benefits and requirements of MRP.

Benefits

MRP enables managers to easily determine the quantities of every component for a given order size, to know when to release orders for each component, and to be alerted when items need attention. Still other benefits include the following:

- Low levels of in-process inventories, due to an exact matching of supply to demand.
- The ability to keep track of material requirements.
- The ability to evaluate capacity requirements generated by a given master schedule.
- A means of allocating production time.
- The ability to easily determine inventory usage by *backflushing*.

backflushing Exploding an end item’s BOM to determine the quantities of the components that were used to make the item.

Backflushing is a procedure in which an end item’s bill of materials (BOM) is periodically exploded to determine the quantities of the various components that were used to make the item, eliminating the need to collect detailed usage information on the production floor.

A range of people in a typical manufacturing company are important users of the information provided by an MRP system. Production planners are obvious users of MRP. Production managers, who must balance workloads across departments and make decisions about scheduling work, and plant foremen, who are responsible for issuing work orders and maintaining production schedules, also rely heavily on MRP output. Other users include customer service representatives, who must be able to supply customers with projected delivery dates; purchasing managers; and inventory managers. The benefits of MRP depend in large measure on the use of a computer to maintain up-to-date information on material requirements.

Requirements

In order to implement and operate an effective MRP system, it is necessary to have:

- A computer and the necessary software programs to handle computations and maintain records
- Accurate and up-to-date:
 - a. Master schedules
 - b. Bills of materials
 - c. Inventory records
- Integrity of file data

Accuracy is absolutely essential for a successful MRP system. Inaccuracies in inventory record files or bill-of-material files can lead to unpleasant surprises, ranging from missing parts to ordering too many of some items and too few of others, and failure to stay on schedule, all of which contribute to an inefficient use of resources, missed delivery dates, and poor customer service. Companies also need to exert scheduling discipline and have in place standard procedures for maintaining and updating bills of material.

Other common problems associated with using MRP include those due to the assumption of constant lead times, products being produced differently from the bill of materials, and failure to alter a bill of materials when customizing a product.

Similarly, inaccurate forecasts can have serious consequences for producers of assembled items. If forecasts are overly optimistic, companies will experience relatively high holding costs, considering the excess inventory represented by the components and raw materials. Conversely, forecasts that are too low will result in shortages of component parts and will require long lead times to acquire the needed components and assemble the products to alleviate the shortages.

LO13.5 Describe some of the difficulties users have encountered with MRP.

13.9 MRP II

MRP was developed as a way for manufacturing companies to calculate more precisely what materials were needed to produce a product, and when and how much of those materials were needed. **Manufacturing resources planning (MRP II)** evolved from MRP because manufacturers recognized additional needs. MRP II expanded the scope of materials planning to include capacity requirements planning, and to involve other functional areas of the organization such as marketing and finance in the planning process.

Material requirements planning is at the heart of the process (see Figure 13.14). The process begins with an aggregation of demand from all sources (e.g., firm orders, forecasts, safety stock requirements). Production, marketing, and finance personnel work toward developing a master schedule. Although manufacturing people will have a major input in determining that schedule and a major responsibility for making it work, marketing and finance will also have important inputs and responsibilities. The rationale for having these functional areas work together is the increased likelihood of developing a plan that works and with which everyone can live. Moreover, because each of these functional areas has been involved in formulating the plan, they will have reasonably good knowledge of the plan and more reason to work toward achieving it.

In addition to the obvious manufacturing resources needed to support the plan, financing resources will be needed and must be planned for, both in amount and timing. Similarly, marketing resources also will be needed in varying degrees throughout the process. In order for the plan to work, the firm must have all of the necessary resources available as needed. Often, an initial plan must be revised based on an assessment of the availability of various resources. Once these have been decided, the master production schedule can be firmed up.

At this point, material requirements planning comes into play, generating material and schedule requirements. Next, management must make more detailed capacity requirements planning

LO13.6 Describe MRP II and its benefits.

manufacturing resources planning (MRP II) Expanded approach to production resource planning, involving other areas of a firm in the planning process and enabling capacity requirements planning.

FIGURE 13.14

An overview of MRP II

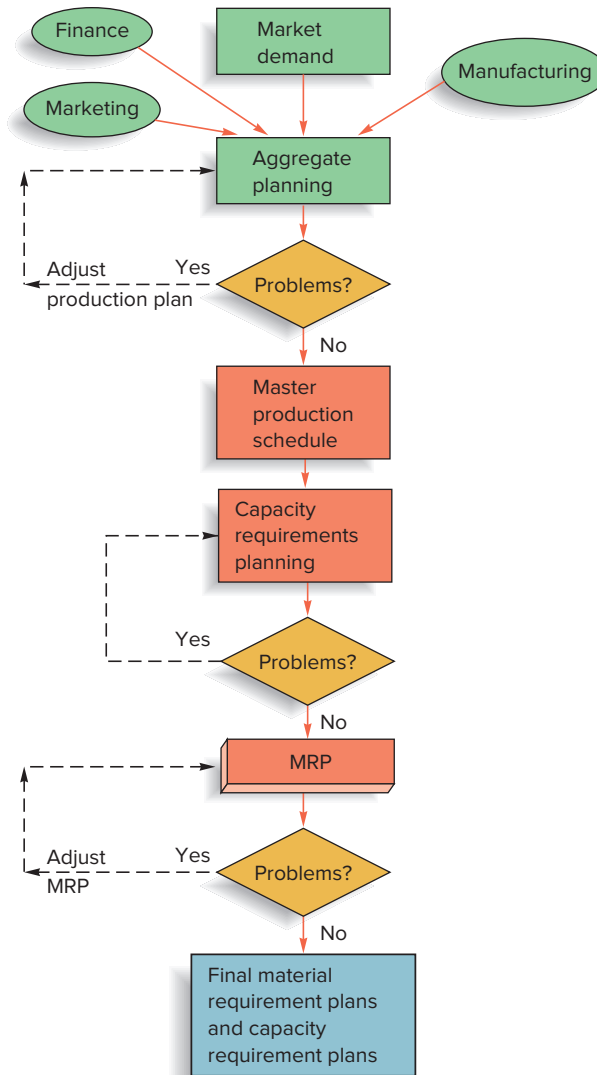

to determine whether these more specific capacity requirements can be met. Again, some adjustments in the master production schedule may be required.

As the schedule unfolds and actual work begins, a variety of reports help managers to monitor the process and to make any necessary adjustments to keep operations on track.

In effect, this is a continuing process, where the master production schedule is updated and revised as necessary to achieve corporate goals. The business plan that governs the entire process usually undergoes changes too, although these tend to be less frequent than the changes made at lower levels (i.e., the master production schedule).

Most MRP II systems have the capability of performing simulations, enabling managers to answer a variety of what-if questions so they can gain a better appreciation of available options and their consequences.

Closed-Loop MRP

When MRP was introduced, it did not have the capability to assess the feasibility of a proposed plan (i.e., if sufficient capacity existed at every level to achieve the plan). Thus, there was no way of knowing before executing a proposed plan if it could be achieved, or after executing the plan if it had been achieved. Consequently, a new plan had to be developed each week. When MRP II systems began to include feedback loops, they were referred to as closed-loop MRP. Closed-loop MRP systems evaluate a proposed material plan relative to available capacity. If a proposed plan is not feasible, it must be revised. The evaluation is referred to as capacity requirements planning.

13.10 CAPACITY REQUIREMENTS PLANNING

One of the most important features of MRP II is its ability to aid managers in capacity planning.

Capacity requirements planning is the process of determining short-range capacity requirements. The necessary inputs include planned-order releases for MRP, the current shop load, routing information, and job times. Key outputs include load reports for each work center. When variances (underloads or overloads) are projected, managers might consider remedies such as alternative routings, changing or eliminating of lot sizing or safety stock requirements, and lot splitting. Moving production forward or backward can be extremely challenging because of precedence requirements and the availability of components.

A firm usually generates a master schedule initially in terms of what is needed but not what is possible. The initial schedule may or may not be feasible given the limits of the production system and availability of materials when end items are translated into requirements for procurement, fabrication, and assembly. Consequently, it is often necessary to run a proposed master schedule through MRP processing in order to obtain a clearer picture of actual requirements, which can then be compared to available capacity and materials. If it turns out that the current master schedule is not feasible, management may make a decision to increase capacity (e.g., through overtime or subcontracting) or to revise the master schedule. In the latter case, this may entail several revisions, each of which is run through the system until a feasible plan is obtained. At that point, the master schedule is *frozen*, at least for the near term, thus establishing a firm schedule from which to plan requirements.

Stability in short-term production plans is very important; without it, changes in order quantity and/or timing can render material requirements plans almost useless. The term *system nervousness* describes the way a system might react to changes. The reaction can sometimes be greater than the original change. For example, a small change near the top of a product tree can reverberate throughout much of the lower parts of the tree, causing major changes to order quantities and production schedules of many components. That, in turn, might cause queues to form at various portions of the system, leading to late orders, increased work in process, and added carrying costs.

To minimize such problems, many firms establish a series of time intervals, called **time fences**, during which changes can be made to orders. For example, a firm might specify time fences of 4, 8, and 12 weeks, with the nearest fence being the most restrictive and the farthest fence being the least restrictive. Beyond 12 weeks, changes are expected; from 8 to 12 weeks, substitutions of one end item for another may be permitted as long as the components are available and the production plan is not compromised; from 4 to 8 weeks, the plan is fixed, but small changes may be allowed; and the plan is frozen out to the 4-week fence.

Some companies use two fences: One is a near-term *demand fence*, and the other is a long-term *planning fence*. For example, the demand fence might be 4 weeks from the present time, while the planning fence might be 10 weeks away. In the near term, customer orders receive precedence over the forecast. The time beyond the planning fence is available for inserting new orders into the master schedule. Between the demand fence and the planning fence, management must make trade-offs when changes are introduced unless excess capacity is expected to be available.

In establishing time fences, a manager must weigh the benefits of stability in the production plan against the possible negative impact on the competitive advantage of being able to quickly respond to new orders.

The capacity planning process begins with a proposed or tentative master production schedule that must be tested for feasibility and possibly adjusted before it becomes permanent. The proposed schedule is processed using MRP to ascertain the material requirements the schedule would generate. These are then translated into resource (i.e., capacity) requirements, often in the form of a series of **load reports** for each department or work center, which compares known and expected future capacity requirements with projected capacity availability. Figure 13.15 illustrates the nature of a load report. It shows expected resource requirements (i.e., usage) for jobs currently being worked on, planned orders, and expected orders for the planning horizon. Given this sort of information, the manager can more easily determine whether capacity is sufficient

LO13.7 Explain how an MRP system is useful in capacity requirements planning.

capacity requirements planning The process of determining short-range capacity requirements.

time fences Series of time intervals during which order changes are allowed or restricted; the nearest fence is most restrictive to change, the farthest is least restrictive.

load reports Department or work center reports that compare known and expected future capacity requirements with projected capacity availability.

FIGURE 13.15

A hypothetical department load profile

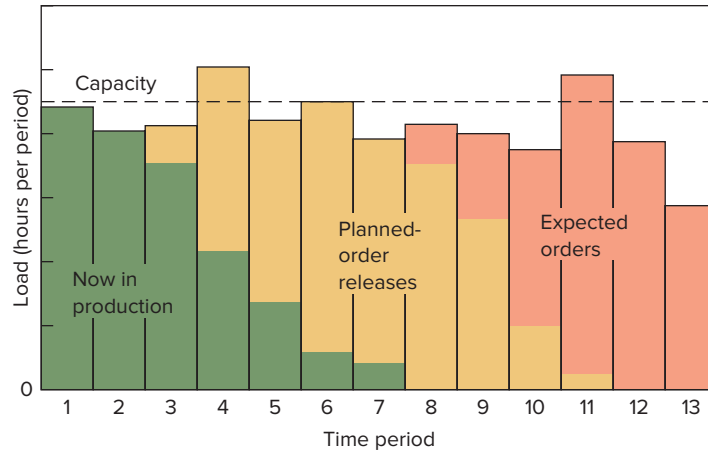

to satisfy these requirements. If there is enough capacity, he or she can freeze the portion of the master production schedule that generates these requirements. In the load profile illustrated in Figure 13.15, planned-order releases in time period 4 will cause an overload. However, it appears possible to accommodate demand by slightly shifting some orders to adjacent periods. Similarly, an overload appears likely in period 11, but that too can be handled by shifting some jobs to adjacent time periods. In cases where capacity is insufficient, a manager may be able to increase capacity (by scheduling overtime, transferring personnel from other areas, or subcontracting some of the work) if this is possible and economical, or else revise the master production schedule and repeat the process until an acceptable production schedule is obtained.

If the master production schedule must be revised, this generally means that the manager must assign priorities to orders, if some orders will be finished later than originally planned.

One note of caution is in order concerning capacity load reports. Often, the load reports are only approximations, and they may not give a true picture because the loading does not take into account scheduling and queuing delays. Consequently, it is possible to experience system backups even though a load report implies sufficient capacity to handle projected loads.

An important aspect of capacity requirements planning is the conversion of quantity requirements into labor and machine requirements. One accomplishes this by multiplying each period's quantity requirements by standard labor and/or machine requirements per unit. For instance, if 100 units of product A are scheduled in the fabrication department, and each unit has a labor standard time of 2 hours and a machine standard time of 1.5 hours, then 100 units of A convert into the following capacity requirements:

$$\begin{aligned} \text{Labor: } & 100 \text{ units} \times 2 \text{ hours/unit} = 200 \text{ machine hours} \\ \text{Machine: } & 100 \text{ units} \times 1.5 \text{ hours/unit} = 150 \text{ machine hours} \end{aligned}$$

One can then compare these capacity requirements with available department capacity to determine the extent to which this product utilizes capacity. For example, if the department has 200 labor hours and 200 machine hours available, labor utilization will be 100 percent because all of the labor capacity will be required by this product. However, machine capacity will be underutilized.

$$\frac{\text{Required}}{\text{Available}} \times 100 = \frac{150 \text{ hours}}{200 \text{ hours}} \times 100 = 75 \text{ percent}$$

Underutilization may mean that unused capacity can be used for other jobs; overutilization indicates that available capacity is insufficient to handle requirements. To compensate, production may have to be rescheduled or overtime may be needed.

Distribution Resource Planning for the Supply Chain

distribution resource planning (DRP) A method used for planning orders in a supply chain.

Distribution resource planning (DRP), also referred to as *distribution requirements planning*, is a method used for planning orders in a supply chain. It extends MRP concepts, enabling a planner to compute time-phased inventory requirements for a supply chain. The goal is to achieve a balance of supply and demand throughout the supply chain.

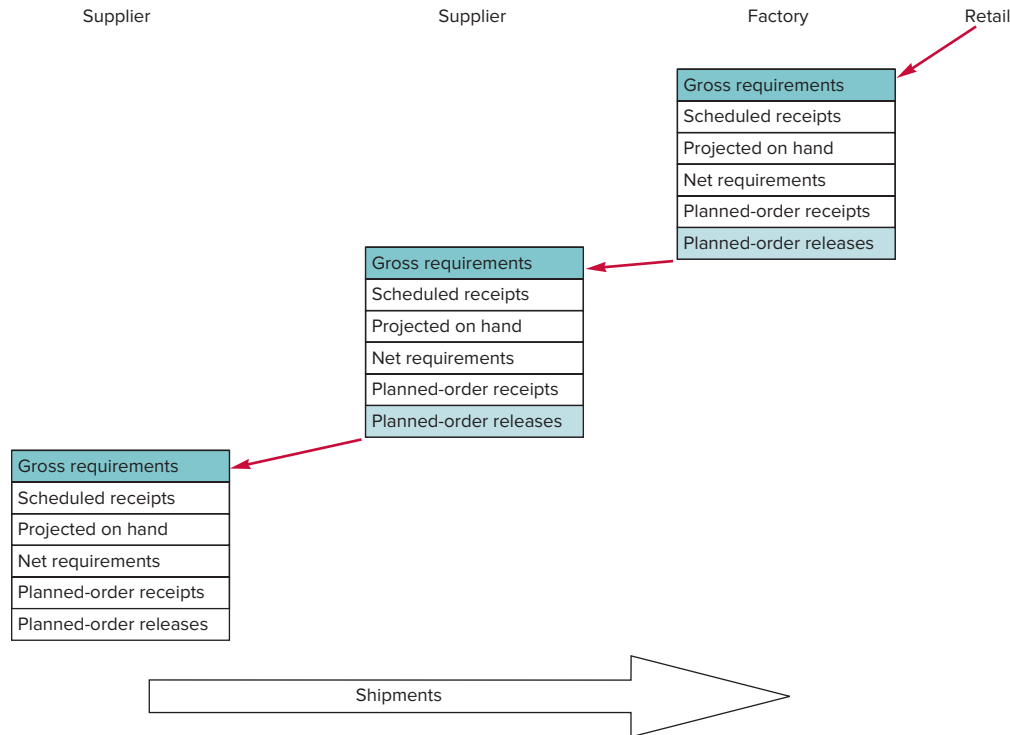

FIGURE 13.16
Supply chain order planning

It begins with a forecast of demand plus actual orders for future periods at the distribution end (e.g., retail) of a supply chain. Other information needed includes the quantity and timing of scheduled receipts at various points in the supply chain, as well as on-hand inventories, and any safety stock requirements. Some versions of DRP also include projections for labor, material handling facilities, and storage space that will be needed.

In a procedure similar to MRP, the planned-order release quantities at each level in the supply chain become the gross requirements one level back, as illustrated in Figure 13.16. In effect, the process pulls inventory shipment through the supply chain based on demand.

13.11 ERP

Business organizations are complex systems in which various functions such as purchasing, production, distribution, sales, human resources, finance, and accounting must work together to achieve the goals of the organization. However, in the functional structure used by many business organizations, information flows freely within each function, but not so between functions. That makes information sharing among functional areas burdensome.

Enterprise resource planning (ERP) is a computerized system designed to connect all parts of a business organization as well as key portions of its supply chain to a single database for the purpose of information sharing. Some of the key connections are depicted in Figure 13.17. SAP and PeopleSoft are major vendors, although there are many others.

ERP software provides a system to capture and make data available in real time to decision makers and other users throughout an organization. It also provides a set of tools for planning and monitoring various business processes to achieve the goals of the organization. ERP systems are composed of a collection of integrated modules. There are many modules to choose from, and different software vendors offer different but similar lists of modules. Some are industry specific, and others are general purpose. The modules relate to the functional areas of business organizations. For example, there are modules for accounting and finance, HR, product planning, purchasing, inventory management, distribution, order tracking, finance, accounting, and marketing. Organizations can select the modules that best serve their needs and budgets. Table 13.1 provides an overview of some widely used modules.

LO13.8 Describe ERP, what it provides, and its hidden costs.

enterprise resource planning (ERP) Integration of financial, manufacturing, and human resources in a single database.

FIGURE 13.17

Key connections to the ERP system

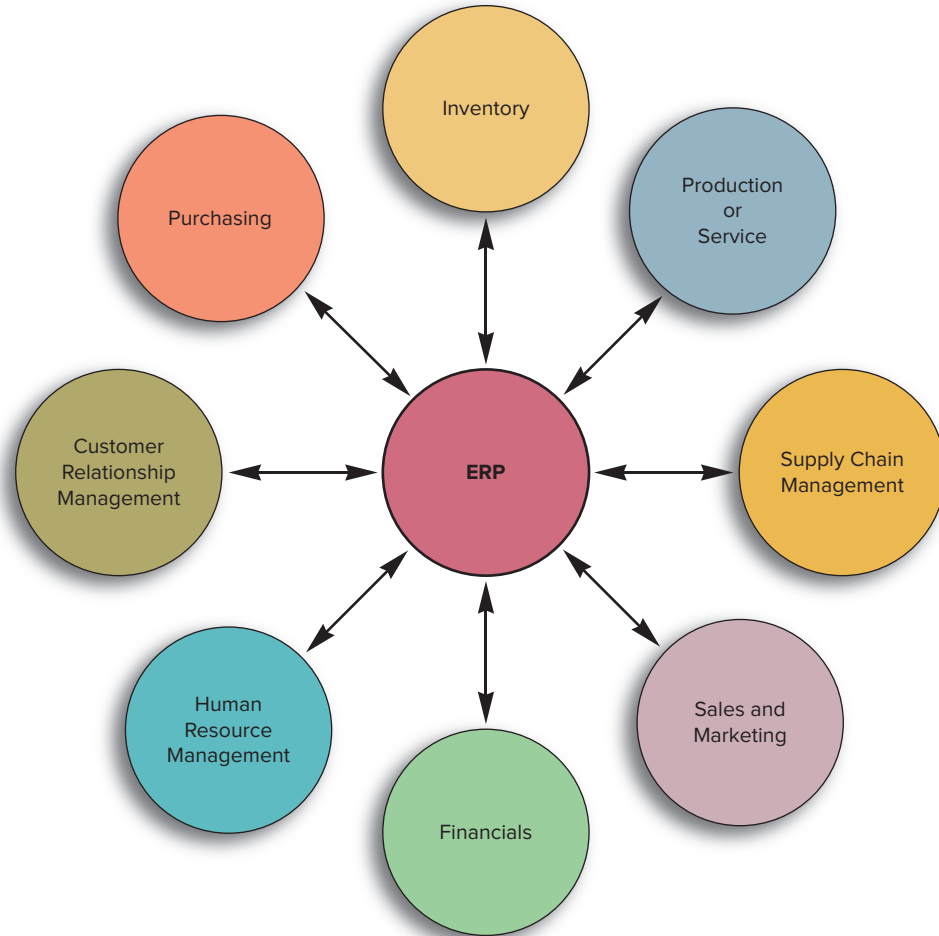

TABLE 13.1

An overview of some ERP software modules

Module	Brief Description
Accounting/Finance	A central component of most ERP systems. It provides a range of financial reports, including general ledger, accounts payable, accounts receivable, payroll, income statements, and balance sheets.
Marketing	Supports lead generation, target marketing, direct mail, and sales.
Human Resources	Maintains a complete database of employee information such as date of hire, salary, contact information, performance evaluations, and other pertinent information.
Purchasing	Facilitates vendor selection, price negotiation, making purchasing decisions, and bill payment.
Production Planning	Integrates information on forecasts, orders, production capacity, on-hand inventory quantities, bills of material, work in process, schedules, and production lead times.
Inventory Management	Identifies inventory requirements, inventory availability, replenishment rules, and inventory tracking.
Distribution	Contains information on third-party shippers, shipping and delivery schedules, delivery tracking.
Sales	Information on orders, invoices, order tracking, and shipping.
Supply Chain Management	Facilitates supplier and customer management, supply chain visibility, and event management.
Customer Relationship Management	Contact information, buying behavior, shipping preferences, contracts, payment terms, and credit history.

An important feature of the modules is that data entered in one module is automatically routed to other modules, so all data are immediately updated and available to all functional areas.

It should be noted that implementations are costly and time consuming, often lasting many years, and require extensive employee training throughout the organization.

The following reading provides additional insight into ERP.

READING



THE ABCS OF ERP

Compiled from reports by Christopher Koch, Derek Slater, and E. Baatz

- What is ERP?
- How can ERP improve a company's business performance?
- How long will an ERP project take?
- What will ERP fix in my business?
- Will ERP fit the way I do business?
- What does ERP *really* cost?
- When will I get payback from ERP—and how much will it be?
- The hidden costs of ERP?
- How do you configure ERP software?
- How do companies organize their ERP projects?
- How does ERP fit with electronic commerce?

What Is ERP?

Enterprise resource planning software, or ERP, doesn't live up to its acronym. Forget about planning—it doesn't do that—and forget about resource, a throwaway term. But remember the enterprise part. This is ERP's true ambition. It attempts to integrate all departments and functions across a company onto a single computer system that can serve all those different departments' particular needs.

That is a tall order, building a single software program that serves the needs of people in finance as well as it does the people in human resources and in the warehouse. Each of those departments typically has its own computer system, each optimized for the particular ways that the department does its work. But ERP combines them all together into a single, integrated software program that runs off a single database so that the various departments can more easily share information and communicate with each other.

That integrated approach can have a tremendous payback if companies install the software correctly. Take a customer order, for example. Typically, when a customer places an order, that order begins a mostly paper-based journey from in-basket to in-basket around the company, often being keyed and rekeyed into different departments' computer systems along the way. All that lounging around in in-baskets causes delays and lost orders, and all the keying into different computer systems invites errors. Meanwhile, no one in the company truly knows what the status of the order is at any given point because there is no way for the finance department, for example, to get into the warehouse's computer system

to see whether the item has been shipped. "You'll have to call the warehouse," is the familiar refrain heard by frustrated customers.

How Can ERP Improve a Company's Business Performance?

ERP automates the tasks involved in performing a business process—such as order fulfillment, which involves taking an order from a customer, shipping it, and billing for it. With ERP, when a customer service representative takes an order from a customer, he or she has all the information necessary to complete the order (the customer's credit rating and order history, the company's inventory levels and the shipping dock's trucking schedule). Everyone else in the company sees the same computer screen and has access to the single database that holds the customer's new order. When one department finishes with the order, it is automatically routed via the ERP system to the next department. To find out where the order is at any point, one need only log into the ERP system and track it down. With luck, the order process moves like a bolt of lightning through the organization, and customers get their orders faster and with fewer mistakes than before. ERP can apply that same magic to the other major business processes, such as employee benefits or financial reporting.

That, at least, is the dream of ERP. The reality is much harsher.

Let's go back to those inboxes for a minute. That process may not have been efficient, but it was simple. Finance did its job, the warehouse did its job, and if anything went wrong outside of the department's walls, it was somebody else's problem. Not anymore. With ERP, the customer service representatives are no longer just typists entering someone's name into a computer and hitting the return key. The ERP screen makes them business people. It flickers with the customer's credit rating from the finance department and the product inventory levels from the warehouse. Will the customer pay on time? Will we be able to ship the order on time? These are decisions that customer service representatives have never had to make before and which affect the customer and every other department in the company. But it's not just the customer service representatives who have to wake up. People in the warehouse who used to keep inventory in their heads or on scraps of paper now need to put that information online. If they don't, customer service will see low inventory levels on their screens and tell customers that their requested item is not

(continued)

(concluded)

in stock. Accountability, responsibility, and communication have never been tested like this before.

How Long Will an ERP Project Take?

Companies that install ERP do not have an easy time of it. Don't be fooled when ERP vendors tell you about a three- or six-month average implementation time. Those short (that's right, six months is short) implementations all have a catch of one kind or another: The company was small, or the implementation was limited to a small area of the company, or the company only used the financial pieces of the ERP system (in which case, the ERP system is nothing more than a very expensive accounting system). To do ERP right, the ways you do business will need to change and the ways people do their jobs will need to change, too. And that kind of change doesn't come without pain. Unless, of course, your ways of doing business are working extremely well (orders all shipped on time, productivity higher than all your competitors, customers completely satisfied), in which case there is no reason to even consider ERP.

The important thing is not to focus on how long it will take—real transformational ERP efforts usually run between one to three years, on average—but rather to understand why you need it and how you will use it to improve your business.

What Will ERP Fix in My Business?

There are three major reasons why companies undertake ERP:

To integrate financial data—As the CEO tries to understand the company's overall performance, he or she may find many different versions of the truth. Finance has its own set of revenue numbers, sales has another version, and the different business units may each have their own versions of how much they contributed to revenues. ERP creates a single version of the truth that cannot be questioned because everyone is using the same system.

To standardize manufacturing processes—Manufacturing companies—especially those with an appetite for mergers and acquisitions—often find that multiple business units across the company make the same widget using different methods and computer systems. Standardizing those processes and using a single, integrated computer system can save time, increase productivity, and reduce headcount.

To standardize HR information—Especially in companies with multiple business units, HR may not have a unified, simple method for tracking employee time and communicating with them about benefits and services. ERP can fix that.

In the race to fix these problems, companies often lose sight of the fact that ERP packages are nothing more than generic representations of the ways a typical company does business. While most packages are exhaustively comprehensive, each industry has its quirks that make it unique. Most ERP systems were designed to be used by discreet manufacturing companies (who make physical things that can be counted), which immediately left all the process manufacturers (oil, chemical, and utility companies that measure their products by flow rather than individual units) out in the cold.

Each of these industries has struggled with the different ERP vendors to modify core ERP programs to their needs.

Will ERP Fit the Ways I Do Business?

It's critical for companies to figure out if their ways of doing business will fit within a standard ERP package before the checks are signed and the implementation begins. The most common reason that companies walk away from multimillion-dollar ERP projects is that they discover the software does not support one of their important business processes. At that point, there are two things they can do: They can change the business process to accommodate the software, which will mean deep changes in long-established ways of doing business (that often provide competitive advantage) and shake up important peoples' roles and responsibilities (something that few companies have the stomach for). Or they can modify the software to fit the process, which will slow down the project, introduce dangerous bugs into the system and make upgrading the software to the ERP vendor's next release excruciatingly difficult, because the customizations will need to be torn apart and rewritten to fit with the new version.

Needless to say, the move to ERP is a project of breathtaking scope, and the price tags on the front end are enough to make the most placid CFO a little twitchy. In addition to budgeting for software costs, financial executives should plan to write checks to cover consulting, process rework, integration testing, and a long laundry list of other expenses before the benefits of ERP start to manifest themselves. Underestimating the price of teaching users their new job processes can lead to a rude shock down the line. So can failure to consider data warehouse integration requirements and the cost of extra software to duplicate the old report formats. A few oversights in the budgeting and planning stage can send ERP costs spiraling out of control faster than oversights in planning almost any other information system undertaking.

What Does ERP Really Cost?

Meta Group recently did a study looking at the Total Cost of Ownership (TCO) of ERP, including hardware, software, professional services, and internal staff costs. The TCO numbers include getting the software installed and the two years afterward, which is when the real costs of maintaining, upgrading, and optimizing the system for your business are felt. Among the 63 companies surveyed—including small, medium, and large companies in a range of industries—the average TCO was \$15 million (the highest was \$300 million and lowest was \$400,000). While it's hard to draw a solid number from that kind of a range of companies and ERP efforts, Meta came up with one statistic that proves that ERP is expensive no matter what kind of company is using it. The TCO for a "heads-down" user over that period was a staggering \$53,320.

When Will I Get Payback from ERP—and How Much Will It Be?

Don't expect to revolutionize your business with ERP. It is a navel-gazing exercise that focuses on optimizing the way things are

done internally rather than with customers, suppliers, or partners. Yet the navel gazing has a pretty good payback if you're willing to wait for it—a Meta Group study of 63 companies found that it took 8 months after the new system was in (31 months total) to see any benefits. But the median annual savings from the new ERP system was \$1.6 million per year.

The Hidden Costs of ERP

Although different companies will find different land mines in the budgeting process, those who have implemented ERP packages agree that certain costs are more commonly overlooked or underestimated than others. Armed with insights from across the business, ERP pros vote the following areas as most likely to result in budget overrun.

- **Training.** Training is the near-unanimous choice of experienced ERP implementers as the most elusive budget item. It's not so much that this cost is completely overlooked as it is consistently underestimated. Training expenses are high because workers almost invariably have to learn a new set of processes, not just a new software interface.
- **Integration and testing.** Testing the links between ERP packages and other corporate software links that have to be built on a case-by-case basis is another often underestimated cost. A typical manufacturing company may have add-on applications for logistics, tax, production planning, and bar coding. If this laundry list also includes customization of the core ERP package, expect the cost of integrating, testing, and maintaining the system to skyrocket. As with training, testing ERP integration has to be done from a process-oriented perspective. Instead of plugging in dummy data and moving it from one application to the next, veterans recommend running a real purchase order through the system, from order entry through shipping and receipt of payment—the whole order-to-cash banana—preferably with the participation of the employees who will eventually do those jobs.
- **Data conversion.** It costs money to move corporate information, such as customer and supplier records, product design data and the like, from old systems to new ERP homes. Although few CIOs will admit it, most data in most legacy systems are of little use. Companies often deny their data are dirty until they actually have to move it to the new client/server setups that popular ERP packages require. Consequently, those companies are more likely to underestimate the cost of the move. But even clean data may demand some overhaul to match process modifications necessitated—or inspired—by the ERP implementation.
- **Data analysis.** Often, the data from the ERP system must be combined with data from external systems for analysis purposes. Users with heavy analysis needs should include the cost of a data warehouse in the ERP budget—and they should expect to do quite a bit of work to make it run smoothly. Users are in a pickle here: Refreshing all the ERP data in a big corporate data warehouse daily is difficult, and ERP systems do a poor job of indicating which information has changed from day to day, making selective warehouse updates tough. One expensive solution is custom programming. The upshot is that the wise will check all their data analysis needs before signing off on the budget.
- **Consultants ad infinitum.** When users fail to plan for disengagement, consulting fees run wild. To avoid this, companies should identify objectives for which [their] consulting partners must aim when training internal staff. Include metrics in the consultants' contract; for example, a specific number of the user company's staff should be able to pass a project-management leadership test—similar to what Big Five consultants have to pass to lead an ERP engagement.
- **Replacing your best and brightest.** ERP success depends on staffing the project with the best and brightest from the business and IS. The software is too complex and the business changes too dramatic to trust the project to just anyone. The bad news is, a company must be prepared to replace many of those people when the project is over. Though the ERP market is not as hot as it once was, consulting firms and other companies that have lost their best people will be hounding yours with higher salaries and bonus offers than you can afford—or that your HR policies permit. Huddle with HR early on to develop a retention bonus program and to create new salary strata for ERP veterans. If you let them go, you'll wind up hiring them—or someone like them—back as consultants for twice what you paid them in salaries.
- **Implementation teams can never stop.** Most companies intend to treat their ERP implementations as they would any other software project. Once the software is installed, they figure, the team will be scuttled and everyone will go back to his or her day job. But after ERP, you can't go home again. You're too valuable. Because they have worked intimately with ERP, they know more about the sales process than the salespeople do and more about the manufacturing process than the manufacturing people do. Companies can't afford to send their project people back into the business because there's so much to do after the ERP software is installed. Just writing reports to pull information out of the new ERP system will keep the project team busy for a year at least. And it is in analysis—and, one hopes, insight—that companies make their money back on an ERP implementation. Unfortunately, few IS departments plan for the frenzy of post-ERP installation activity, and fewer still build it into their budgets when they start their ERP projects. Many are forced to beg for more money and staff immediately after the go-live date, long before the ERP project has demonstrated any benefit.
- **Waiting for ROI.** One of the most misleading legacies of traditional software project management is that the company expects to gain value from the application as soon as it is installed; the project team expects a break, and maybe a pat on the back. Neither expectation applies to ERP. Most don't reveal their value until after companies have had them running for some time and can concentrate on making improvements in the business processes affected by the system. And the project team is not going to be rewarded until their efforts pay off.

(continued)

(concluded)

- **Post-ERP depression.** ERP systems often wreak havoc in the companies that install them. In a recent Deloitte Consulting survey of 64 Fortune 500 companies, 1 in 4 admitted they suffered a drop in performance when their ERP systems went live. The true percentage is undoubtedly much higher. The most common reason for the performance problems is that everything looks and works differently from the way it did before. When people can't do their jobs in the familiar way and haven't yet mastered the new way, they panic, and the business goes into spasms.

How Do You Configure ERP Software?

Even if a company installs ERP software for the so-called right reasons and everyone can agree on the optimal definition of a customer, the inherent difficulties of implementing something as complex as ERP is like, well, teaching an elephant to do the hootchy-kootchy. The packages are built from database tables, thousands of them, that IS programmers and end users must set to match their business processes; each table has a decision “switch” that leads the software down one decision path or another. By presenting only one way for the company to do each task—say, run the payroll or close the books—a company's individual operating units and far-flung divisions are integrated under one system. But figuring out precisely how to set all the switches in the tables requires a deep understanding of the existing processes being used to operate the business. As the table settings are decided, these business processes are reengineered, ERP's way. Most ERP systems are not shipped as a shell system in which customers must determine at the minutia level how all the functional procedures should be set, making thousands of decisions that affect how their system behaves in line with their own business activities. Most ERP systems are preconfigured, allowing just hundreds—rather than thousands—of procedural settings to be made by the customer.

How Do Companies Organize Their ERP Projects?

Based on our observations, there are three commonly used ways of installing ERP.

The big bang—In this, the most ambitious and difficult of approaches to ERP implementation, companies cast off all their legacy systems at once and implement a single ERP system across the entire company.

Though this method dominated early ERP implementations, few companies dare to attempt it anymore because it calls for the entire company to mobilize and change at once. Most of the ERP implementation horror stories from the late 90s warn us about companies that used this strategy. Getting everyone to cooperate and accept a new software system at the same time is a tremendous effort, largely because the new system will not have any advocates. No one within the company has any experience using it, so no one is sure whether it will work. Also, ERP inevitably involves compromises. Many departments have computer systems that have been honed to match the ways they work. In most cases, ERP offers neither the range of functionality, nor the comfort of

familiarity that a custom legacy system can offer. In many cases, the speed of the new system may suffer because it is serving the entire company rather than a single department. ERP implementation requires a direct mandate from the CEO.

Franchising strategy—This approach suits large or diverse companies that do not share many common processes across business units. Independent ERP systems are installed in each unit, while linking common processes, such as financial book-keeping, across the enterprise.

This has emerged as the most common way of implementing ERP. In most cases, the business units each have their own “instances” of ERP—that is, a separate system and database. The systems link together only to share the information necessary for the corporation to get a performance big picture across all the business units (business unit revenues, for example), or for processes that don't vary much from business unit to business unit (perhaps HR benefits). Usually, these implementations begin with a demonstration or “pilot” installation in a particularly open-minded and patient business unit where the core business of the corporation will not be disrupted if something goes wrong. Once the project team gets the system up and running and works out all the bugs, the team begins selling other units on ERP, using the first implementation as a kind of in-house customer reference. Plan for this strategy to take a long time.

Slam-dunk—ERP dictates the process design in this method, where the focus is on just a few key processes, such as those contained in an ERP system's financials module. The slam-dunk is generally for smaller companies expecting to grow into ERP.

The goal here is to get ERP up and running quickly and to ditch the fancy reengineering in favor of the ERP system's “canned” processes. Few companies that have approached ERP this way can claim much payback from the new system. Most use it as an infrastructure to support more diligent installation efforts down the road. Yet many discover that a slammed-in ERP system is little better than a legacy system, because it doesn't force employees to change any of their old habits. In fact, doing the hard work of process reengineering after the system is in can be more challenging than if there had been no system at all, because at that point few people in the company will have felt much benefit.

How Does ERP Fit with Electronic Commerce?

After all of that work inventing, perfecting, and selling ERP to the world, the major ERP vendors are having a hard time shifting gears from making the applications that streamline business practices inside a company to those that face outward to the rest of the world. These days, the hottest areas for outward-looking (that is, Internet) post-ERP work are electronic commerce, planning and managing your supply chain, and tracking and serving customers. Most ERP vendors have been slow to develop offerings for these areas, and they face stiff competition from niche vendors. ERP vendors have the advantage of a huge installed base of customers and a virtual stranglehold on the “back office” functions—such as order fulfillment. Recently, ERP vendors have begun to shrink their ambitions

and focus on being the back-office engine that powers electronic commerce, rather than trying to own all the software niches necessary for a good electronic commerce website. Indeed, as the niche vendors make their software easier to hook into electronic commerce websites, and as middleware vendors make it easier for IS departments to hook together applications from different vendors, many people wonder how much longer ERP vendors can claim to be the primary platform for the Fortune 500.

Questions

1. What is ERP?
2. What are the three main reasons firms adopt ERP?
3. What are some hidden costs of ERP?
4. How does ERP fit with e-commerce and supply chain management?

Source: Christopher Koch, "ABC: An Introduction to ERP," Cio.com. Copyright © 2008 CXO Media. Used with permission.

ERP in Services

Although ERP was initially developed for manufacturing, it now has a long list of service applications. These include professional services, postal services, retail, banking, health care, higher education, engineering and construction services, logistics services, and real estate management.

In a manufacturing environment, ERP systems generally encompass the major functions, such as production planning and scheduling, inventory management, product costing, and distribution. In a service environment, the major functions can differ from one service organization to another. For example, many universities employ ERP systems; they typically are used to integrate and access student information, course prerequisites, course schedules, room schedules, human resources, accounting, and financial information. Hospitals' ERP systems include patient records, medication data, treatment plans, and scheduling information (e.g., rooms, equipment, surgery), as well as human resources information.

ERP is now about enterprise applications *integration*, an issue that generally arises with any major technology acquisition. The following reading underscores this point.

READING



11 COMMON ERP MISTAKES AND HOW TO AVOID THEM

Experts in enterprise resource planning software discuss some of the most common missteps IT leaders make when choosing, deploying and implementing an ERP system — and what they can do to prevent or circumvent them.

BY JENNIFER LONOFF SCHIFF



Thinkstock

Today's IT executives have more choices than ever when choosing an enterprise resource planning (ERP) solution. From on-premises

systems to cloud-based software-as-a-service to industry-based solutions, there is a dazzling array. And decision makers can feel overwhelmed when trying to determine which features and functions are the most important.

So CIO.com reached out to dozens of ERP experts, for advice on how to navigate this complex landscape. Specifically, we asked them to identify the biggest mistakes they see executives make when choosing, deploying or implementing an ERP system — as well as for suggestions as to how organizations can avoid making potentially costly errors.

1. **Not doing careful requirements gathering** "It is very common, and very tempting, to take existing business processes as is and automate them with [an] ERP system," says Ed Featherston, vice president and principal architect at Cloud Technology Partners, a consulting company. "While conceptually this is understandable, you must take the time and make the effort to analyze those processes as part of your ERP requirements gathering. Implementing a new ERP system is an opportunity to identify and improve/redesign your business processes. Automating a bad process only makes a bad process run faster."

Similarly, "too many companies fail to identify crucial software usage issues/pain points and map out critical processes

(continued)

(concluded)

prior to beginning migration to a new ERP solution,” says Brian Berns, CEO of Knoa Software, which delivers enterprise cloud solutions. “Business-critical issues must be identified and addressed before the migration, so that necessary adjustments can be made to outdated, inefficient and complex processes before they are simply moved onto a new platform.”

2. **Not including end-users (from all departments) in the decision-making process** “When implementing an ERP system, many organizations focus their time and effort on gaining approval from leadership executives, when they should be engaging key employees who will be using the system the most,” argues Kevin Beasley, CIO of VAI, an ERP software company.

“It’s crucial to involve employees not just from IT, but across the entire organization from finance, operations, manufacturing and warehouse,” he says. “Engaging stakeholders across the entire organization in every step of the decision-making process will ensure everyone is invested in finding and implementing the right solution as smoothly as possible.”

3. **Not properly budgeting for technology staff** “We often see leaders underestimate the expenses involved with an implementation, which include maintenance and the level of talent needed to get the project off the ground successfully,” says Tim Webb, practice director of enterprise technology services at Robert Half Technology, a provider of technology staffing. “In instances where organizations are trying to accomplish more with less . . . we’ve seen it result in failed implementations. Take the time to properly budget, [taking into account] the talent driving the implementation, so you don’t come up against issues or surprises [later].”

4. **Not weighing the pros and cons of on-premises vs. cloud-based ERP** Before deciding between an on-premises and a cloud-based ERP solution, “businesses [should] evaluate several factors,” says Mark Canes, president of Blue Link, an accounting and inventory ERP software provider. “For example, a cloud deployment requires proper internet connectivity, subscription-type payments and comes with benefits such as catering to employees who work remotely. On the other hand, on-premises deployment requires a dedicated IT staff, up-to-date servers and hardware in-house and large upfront fees, which is suitable for those who want to host the software on their own servers.”

“With software-as-a-service fast becoming the predominate platform for new ERP implementations, SaaS may seem like the perfect solution for organizations who experienced difficult implementations or have struggled to support their earlier ERP investments,” says Nathan Frey, partner at Information Services Group, a technology research and advisory firm. “While SaaS does offer many benefits, clients [need to understand] the new organizational challenges that SaaS can pose.

“As SaaS solutions cannot be customized, users are forced to adapt business processes to the software,” he explains. “These process changes often impact integration with legacy systems, which can expand organizational change management concerns. Additionally, organizations with unique functional

or industry-specific requirements will need a structure and approach to address necessary functionality not provided by the new system, either through work-arounds, third-party software or alternative means.”

5. **Not including an industry-specific solution in the decision-making process (if relevant)** When choosing an ERP solution, executives often overlook the fact that “there are a lot of very good small software companies that support specific industries with specialized needs, such as pharmaceutical distribution,” says Canes. And these specialized vendors/solutions “may provide more industry-specific features [and] software customization,” which may be a better fit for your business.
6. **Being dazzled by features** “Features are important, but they aren’t everything,” notes Nathan Brown, CTO of EVS, a provider of warehouse management systems. “Too often, an organization selects the ERP that has the longest features matrix.” Instead, businesses should consider the solution’s “industry success history, customization, flexibility and integration ability,” as well as customer support, in addition to how well the solution addresses the organization’s needs/requirements.
7. **Implementing the system at once (or trying to)** “ERP systems are complex, and it is not possible to determine all the implementation requirements up front, then implement the system, train users and go live,” says Sunil Pande, CEO of cloud ERP platform VersAccounts. “This is the traditional waterfall model of implementation and it does not work. Instead a more agile approach needs to be taken, [where] implementation [is] done in small steps with end-user involvement at every step to determine requirements, test, find gaps and then repeat.”
8. **Ignoring change management** “Change management is an absolute requirement when implementing a new ERP solution,” states Jeff Carr, founder and CEO of Ultra Consultants, an independent research and enterprise solutions consulting firm serving the manufacturing and distribution industries. “The ability to effectively manage change may very well be the most important skill that executives, managers and employees need to master. Business transformations through ERP will not take place without effectively managing change across three key organizational areas: people, process and technology.”

“All too often, organizations look only at the IT technology to unify, streamline and simplify business operations,” says Akhilesh Tiwari, global head of enterprise application services at Tata Consultancy Services. “While processes and systems require deep analysis, the people factor needs as much careful consideration and strategic planning as the rest. This is even more critical during a cloud ERP migration.”

Even cloud-based ERP solutions require change management.

“SaaS solutions bring the promise of configurable business processes and more intuitive user interfaces than prior ERP software offerings,” says Frey. “This often leads organizations to assume that organizational change management and training are less important for SaaS projects.” However, “SaaS solutions place greater burdens on clients to adapt current business processes to the software.

“To avoid rework and ensure that end users thoroughly understand the changes that will occur upon go-live, organizations [should] identify necessary process changes early in the implementation project,” Frey recommends. “Additionally, end-user training must consider not only the transactional aspects of a user’s role but also the changing interaction with other users and with systems not part of the new solution. By delivering [appropriate, timely] training, users are likely to accept the new system at a faster pace and with greater success.”

9. **Not investing in/supporting the implementation team** “[Properly] structuring the internal implementation team and giving it the [necessary] time and resources it needs to carry out the implementation and associated business transformation is one of the most critical steps of an ERP project,” explains Carr. “A successful team requires the right people, with executive buy-in and decision-making power to get the job done. This often means re-assigning the day-to-day responsibilities [of team members],” but doing so can be the difference between a successful rollout and failure.
10. **Not regularly communicating information (especially across departments)** To avoid this problem, “create a project communication plan for all phases of the project,” suggests Dave Goossens, executive vice president of professional services at ERP vendor Unit4. Put together “a small core team [composed of individuals from different departments] that communicates and works well with one another and that has influence in the business areas most affected by the new solution. Then make sure they are [kept] fully up-to-date on project progress at all times” and, in turn, keep all those in affected areas up to date.
11. **Not having a maintenance plan** “Implementing an ERP system takes time, but the work hardly stops once the system is successfully in place,” says Beasley. “Businesses should implement a maintenance strategy to ensure workers are aligned on what needs to be done to maintain and improve the ERP system on a regular basis so it doesn’t become outdated or obsolete.”

“Outdated ERP systems can put companies at risk for security issues and holes in their business processes,” he explains. “Having a set plan and assigning who in the company is responsible for the project and maintenance at a given time will ensure the ERP system is always running smoothly and is up-to-date with the latest applications.”

Conversion to an ERP system from a traditional operation is a major undertaking that requires a project approach to manage the process.

13.12 OPERATIONS STRATEGY

Acquisition of technology on the order of ERP has strategic implications. Among the considerations are a high initial cost, a high cost to maintain, the need for future upgrades, and the intensive training required. An ERP team is an excellent example of the value of a cross-functional team. Purchasing, which will ultimately place the order, typically does not have the technical expertise to select the best vendor. Information technology can assess various technical requirements, but won’t be the user. Various functional users (marketing, operations, and accounting) will be in the best position to evaluate inputs and outputs, and finance must evaluate the effect on the organization’s bottom line. Also, it is important to have a member of the purchasing staff involved from the beginning of negotiations on ERP acquisition because this will have major implications for purchasing.

The real-time aspect of ERP makes it valuable as a strategic planning tool. For example, it can improve supply chain management, with stronger links between their customers and their suppliers, and make the organizations more capable of satisfying changing customer requirements.

Because ERP tracks the flow of information and materials through a company, it offers opportunities for collecting information on waste and environmental costs and, hence, opportunities for process improvement.

MRP is a planning technique that creates a schedule for all the (dependent-demand) items in an end item’s bill of materials based on fixed manufacturing lead times. The end item is exploded using the bill of materials, and material requirements plans are developed that show quantity and timing for ordering or producing components.

The main features of MRP are the time-phasing of requirements, calculating component requirements, and planned-order releases. To be successful, MRP requires accurate master production schedules, bills of materials, and inventory data. Firms without reasonably accurate records or schedules have experienced major difficulties in trying to implement MRP-type systems. A potential weakness of MRP is the assumption of constant lead times.

SUMMARY

MRP is utilized by most MRP II and ERP systems. MRP II adds software applications designed to better manage the entire manufacturing process involving finance and marketing, and including capacity planning. ERP is the third generation of manufacturing software that encompasses all business functions, including order entry and an option for financial management *integrated* with the manufacturing functions available in MRP II.

KEY POINTS

1. The usage of components in production of assembled items depends on how many of each component are needed per item, and how many items are to be produced. Hence, the term *dependent demand*.
2. MRP is a tool used for dependent-demand components, to assist in making the two basic decisions in inventory management: how much of each component to order or make, and when to order or make it.
3. MRP II is an enhancement of MRP that gives management the ability to relate financial and other information to an MRP plan.
4. ERP is a software-based enterprise-wide system that allows access to production, sales, accounting, warehouse, and supply chain information.

KEY TERMS

- | | | |
|---|--|----------------------------------|
| backflushing, 576 | gross requirements, 567 | pegging, 572 |
| bill of materials (BOM), 563 | inventory records, 566 | performance-control reports, 574 |
| capacity requirements planning, 579 | load reports, 579 | planned-order receipts, 568 |
| changes, 574 | low-level coding, 566 | planned-order releases, 568 |
| cumulative lead time, 563 | manufacturing resources planning (MRP II), 577 | planned orders, 574 |
| dependent demand, 561 | master schedule, 563 | planning reports, 574 |
| distribution resource planning (DRP), 580 | material requirements planning (MRP), 562 | product structure tree, 563 |
| enterprise resource planning (ERP), 581 | net-change system, 572 | projected on hand, 567 |
| exception reports, 574 | net requirements, 567 | regenerative system, 572 |
| | order releases, 574 | scheduled receipts, 567 |
| | | time fences, 579 |

SOLVED PROBLEMS

Problem 1 The following product structure tree indicates the components needed to assemble one unit of product W. Determine the quantities of each component needed to assemble 100 units of W.

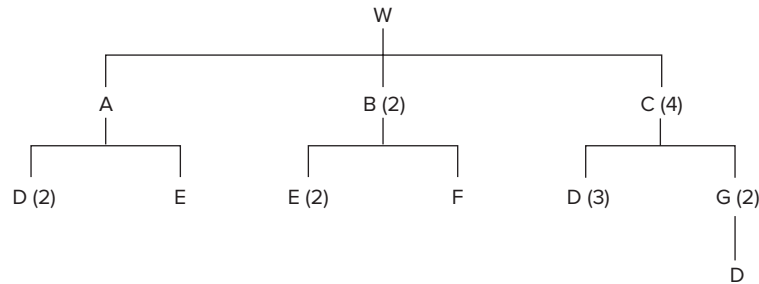

Solution An easy way to compute and keep track of component requirements is to do it right on the tree, as shown in the following figure. *Note:* For the procedure when there are on-hand inventories, see Example 1.

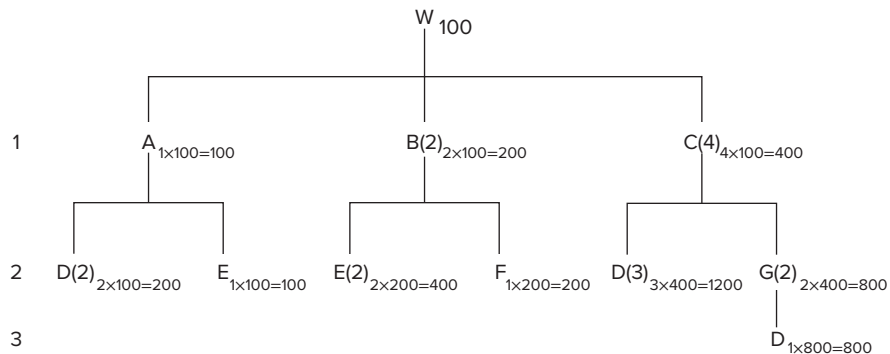

Summary:

Level	Item	Quantity
0	W	100
1	A	100
	B	200
	C	400
2	E	500
	F	200
	G	800
3	D	2,200

Material Requirements Plan Setup Guide

Twelve units of the end item are needed at the beginning of week 6. Prepare a material requirements plan for component D, given that there is a scheduled receipt of 10 units of subassembly A in week 3 plus the following information.

Problem 2

Item	End	A	B	C	D
Units on hand	2	6	4	32	15
Lead time (weeks)	1	2	1	2	2

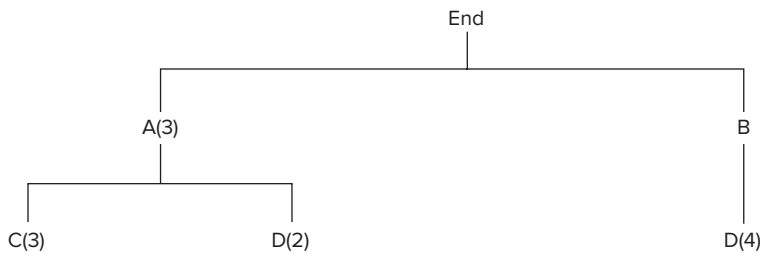

Steps

1. If a question asks for a materials requirement plan for a component such as D in the tree diagram, circle all occurrences of that component so you will be sure to include them.
2. Label the spreadsheet sections, top to bottom, following the order shown in the tree diagram:
 Top section: End Item Next section: A Next section: B Last section: D
 (You don't need one for C because the problem asks for D, and C isn't needed for D.)
3. Add the LT (lead time) for the end item and each component next to the section labels.
4. Add any beginning inventory (on hand) for the end item and each component to their spreadsheet sections.
5. Place the desired end item quantity in the master schedule in the week it is needed, and in the gross requirements of the end item in that same week.
6. Complete the remainder of the plan.

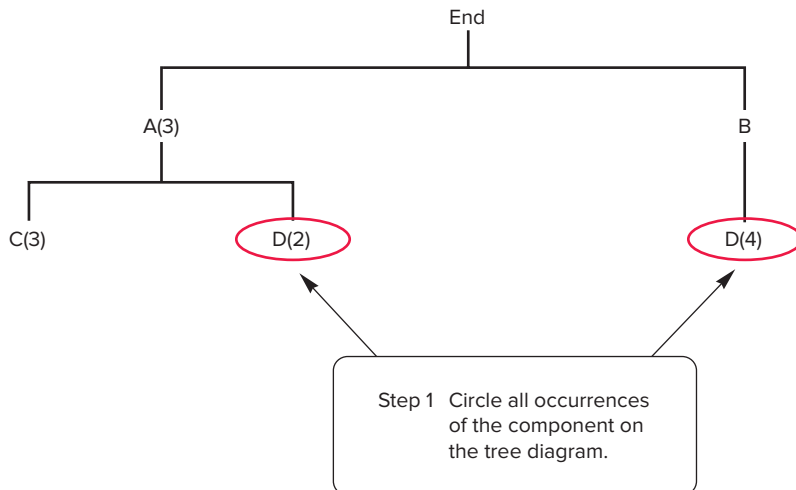

Master	Week	1	2	3	4	5	6
Schedule	Quantity						

End	Beg. Inv.	1	2	3	4	5	6
Gross requirements							
Scheduled receipts							
Projected on hand							
Net requirements							
Planned-order receipts							
Planned-order releases							

A (3)	Beg. Inv.	1	2	3	4	5	6
Gross requirements							
Scheduled receipts							
Projected on hand							
Net requirements							
Planned-order receipts							
Planned-order releases							

B	Beg. Inv.	1	2	3	4	5	6
Gross requirements							
Scheduled receipts							
Projected on hand							
Net requirements							
Planned-order receipts							
Planned-order releases							

D(2) D(4)	Beg. Inv.	1	2	3	4	5	6
Gross requirements							
Scheduled receipts							
Projected on hand							
Net requirements							
Planned-order receipts							
Planned-order releases							

Step 2. Label spreadsheet sections in the order shown in the tree diagram.

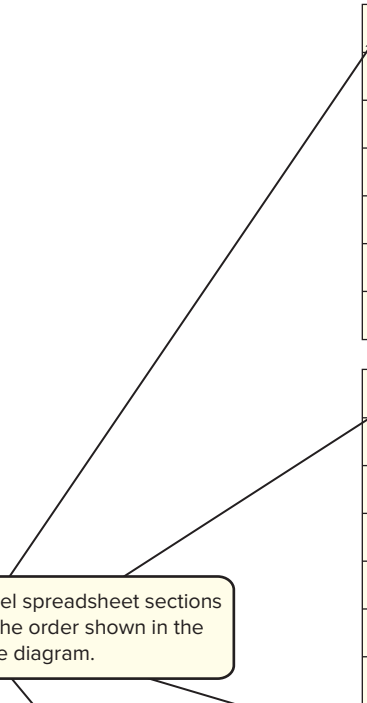

Step 3. Add lead times.

Master	Week	1	2	3	4	5	6
Schedule	Quantity						

End	LT = 1	Beg. Inv.	1	2	3	4	5	6
Gross requirements								
Scheduled receipts								
Projected on hand								
Net requirements								
Planned-order receipts								
Planned-order releases								

A (3)	LT = 2	Beg. Inv.	1	2	3	4	5	6
Gross requirements								
Scheduled receipts								
Projected on hand								
Net requirements								
Planned-order receipts								
Planned-order releases								

B	LT = 1	Beg. Inv.	1	2	3	4	5	6
Gross requirements								
Scheduled receipts								
Projected on hand								
Net requirements								
Planned-order receipts								
Planned-order releases								

D(2) D(4)	LT = 2	Beg. Inv.	1	2	3	4	5	6
Gross requirements								
Scheduled receipts								
Projected on hand								
Net requirements								
Planned-order receipts								
Planned-order releases								

Master	Week	1	2	3	4	5	6
Schedule	Quantity						

End	LT = 1	Beg. Inv.	1	2	3	4	5	6
Gross requirements								
Scheduled receipts								
Projected on hand		2						
Net requirements								
Planned-order receipts								
Planned-order releases								

A (3)	LT = 2	Beg. Inv.	1	2	3	4	5	6
Gross requirements								
Scheduled receipts					10			
Projected on hand		6						
Net requirements								
Planned-order receipts								
Planned-order releases								

B	LT = 1	Beg. Inv.	1	2	3	4	5	6
Gross requirements								
Scheduled receipts								
Projected on hand		4						
Net requirements								
Planned-order receipts								
Planned-order releases								

D(2) D(4)	LT = 2	Beg. Inv.	1	2	3	4	5	6
Gross requirements								
Scheduled receipts								
Projected on hand		15						
Net requirements								
Planned-order receipts								
Planned-order releases								

Step 4. Enter specified beginning inventory and scheduled receipts quantities.

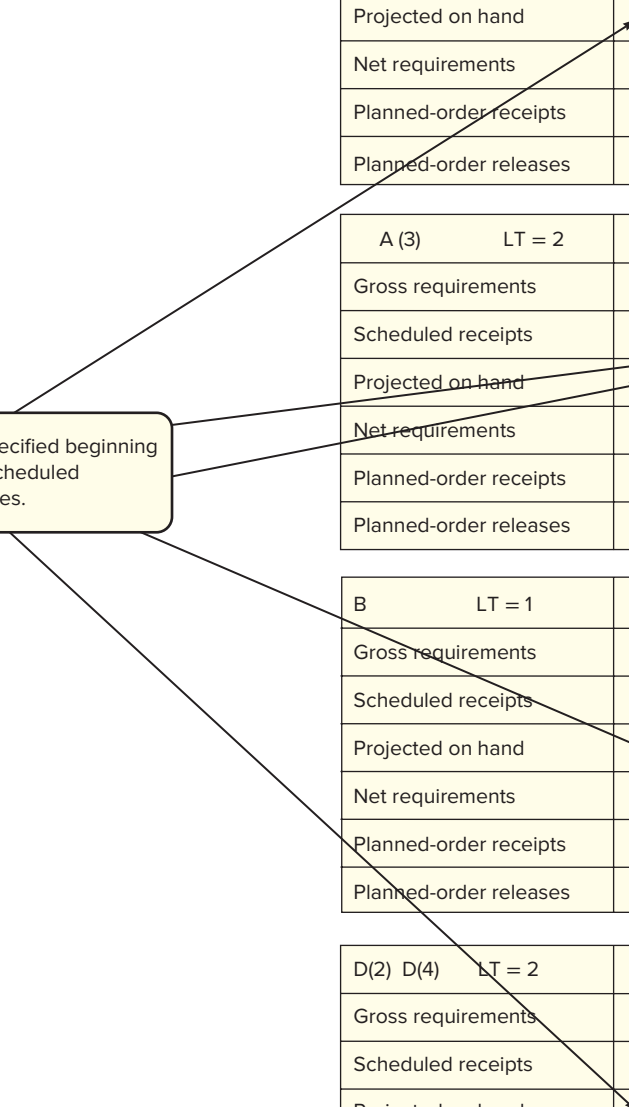

Master	Week	1	2	3	4	5	6
Schedule	Quantity						12

Step 5 . Enter the master schedule quantities and end item gross requirements in the specified week(s).

End	LT = 1	Beg. Inv.	1	2	3	4	5	6
Gross requirements								12
Scheduled receipts								
Projected on hand		2						
Net requirements								
Planned-order receipts								
Planned-order releases								

A (3)	LT = 2	Beg. Inv.	1	2	3	4	5	6
Gross requirements								
Scheduled receipts					10			
Projected on hand		6						
Net requirements								
Planned-order receipts								
Planned-order releases								

B	LT = 1	Beg. Inv.	1	2	3	4	5	6
Gross requirements								
Scheduled receipts								
Projected on hand		4						
Net requirements								
Planned-order receipts								
Planned-order releases								

D(2) D(4)	LT = 2	Beg. Inv.	1	2	3	4	5	6
Gross requirements								
Scheduled receipts								
Projected on hand		15						
Net requirements								
Planned-order receipts								
Planned-order releases								

Master	Week	1	2	3	4	5	6
Schedule	Quantity						12

End	LT = 1	Beg. Inv.	1	2	3	4	5	6
Gross requirements								12
Scheduled receipts								
Projected on hand		2	2	2	2	2	2	2
Net requirements								10
Planned-order receipts								10
Planned-order releases							10	

Step 6. Complete the remainder of the plan, starting with the end item and working down, subtracting projected on hand from gross requirements to get net requirements. Planned-order receipts = Net requirements, and all are in the same week. Planned-order releases are always the same as planned-order receipts, but earlier by lead time (one week in this case).

A (3)	LT = 2	Beg. Inv.	1	2	3	4	5	6
Gross requirements							30	
Scheduled receipts				10				
Projected on hand		6	6	6	16	16	16	
Net requirements							14	
Planned-order receipts							14	
Planned-order releases				14				

Subassemblies A and B both come under End in the tree diagram, so their gross requirements are in the same column as the End item's planned-order releases (Week 5), using the multiples given in the tree diagram:
 3 times 10 for A = 30
 1 times 10 for B = 10

B	LT = 1	Beg. Inv.	1	2	3	4	5	6
Gross requirements							10	
Scheduled receipts								
Projected on hand		4	4	4	4	4	4	
Net requirements							6	
Planned-order receipts							6	
Planned-order releases					6			

D(2) comes under A in the tree diagram, so its gross requirements are related to A's planned-order releases and in that same week:
 2 times 14 = 28 in week 3
 D(4) comes under B in the tree diagram, so its gross requirements are related to B's planned-order releases and in that same week:
 4 times 6 = 24 in week 4

D(2) D(4)	LT = 2	Beg. Inv.	1	2	3	4	5	6
Gross requirements					28	24		
Scheduled receipts								
Projected on hand		15	15	15	15			
Net requirements					13	24		
Planned-order receipts					13	24		
Planned-order releases			13	24				

The product structure tree for end item E follows. The manager wants to know the material requirements for ordered part R that will be needed to complete 120 units of E by the start of week 5. Lead times for items are one week for level 0 items, one week for level 1 items, and two weeks for level 2 items. There is a scheduled receipt of 60 units of M at the *start* of week 2 and 100 units of R at the *start* of week 1. Lot-for-lot ordering is used.

Problem 3

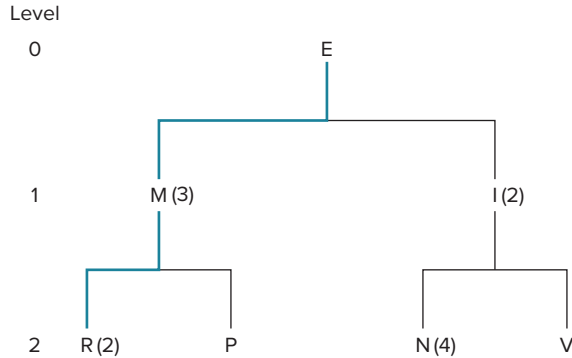

A partial assembly-time chart that includes R and leads to completion of E by the start of week 5 looks like this:

Solution

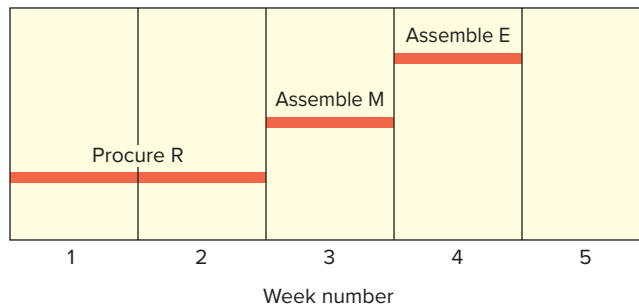

The table entries are arrived at as follows:

Master schedule: 120 units of E to be available at the start of week 5.

Item E: Gross requirements equal the quantity specified in the master production schedule. Because there is no on-hand inventory, net requirements also equal 120 units. Using lot-for-lot ordering, 120 units must be scheduled to be available at the start of week 5. Because there is a one-week lead time for assembly of Es, an order will need to be released (i.e., work started) at the beginning of week 4.

Item M: The *gross* requirements for M are three times the *net* requirements for E, because each E requires three Ms. These must be available at the start of week 4. The net requirements are 60 units fewer due to the 60 units expected to be on hand at that time. Hence, 300 additional units of M must be available at the start of week 4. With the one-week lead time, there must be an order release at the start of week 3.

Item R: Because each M requires two units of R, 600 Rs will be needed to assemble 300 units of M. However, 100 units will be on hand, so only 500 need to be ordered. Because there is a lead time of two weeks, the 500 Rs must be ordered at the start of week 1.

The master schedule for E and requirements plans for E, M, and R follow.

Master schedule for E

Week number	Beg. Inv.	1	2	3	4	5
Quantity						120

Item: E LT = 1 week						
Gross requirements						120
Scheduled receipts						
Projected on hand						
Net requirements						120
Planned-order receipts						120
Planned-order releases					120	

Multiplied by 3
(see product tree)

Item: M LT = 1 week						
Gross requirements						360
Scheduled receipts			60			
Projected on hand			60	60	60	
Net requirements						300
Planned-order receipts						300
Planned-order releases					300	

Multiplied by 2
(see product tree)

Item: R LT = 2 weeks						
Gross requirements						600
Scheduled receipts		100				
Projected on hand		100	100	100		
Net requirements						500
Planned-order receipts						500
Planned-order releases		500				

Problem 4 Capacity Requirements Planning

Given the following production schedule in units and the production standards for labor and machine time for this product, determine the labor and machine capacity requirements for each week. Then, compute the percent utilization of labor and machines in each week if labor capacity is 200 hours per week and machine capacity is 250 hours per week.

Production Schedule:

Week	1	2	3	4
Quantity	200	300	100	150

Standard Times:

Labor	.5 hour/unit
Machine	1.0 hour/unit

Convert the quantity requirements into labor and machine requirements by multiplying the quantity requirements by the respective standard times (i.e., multiply each quantity by .5 to obtain the labor hours and multiply each quantity by 1.0 to obtain the machine hours):

Week	1	2	3	4
Quantity	200	300	100	150
Labor hours	100	150	50	75
Machine hours	200	300	100	150

To compute utilization, divide the capacity requirements by the available capacity (200 hours per week for labor and 250 hours per week for machine) and multiply by 100. The results are

Week	1	2	3	4
Labor	50%	75%	25%	37.5%
Machine	80%	120%	40%	60%

Note that machine capacity in week 2 is overutilized (i.e., capacity is insufficient) because the utilization exceeds 100 percent. To compensate, some production could be shifted to weeks 1 and/or 3, where labor and machine time are available.

Solution

1. Contrast independent and dependent demand.
 2. When is MRP appropriate?
 3. Briefly define or explain each of the following terms.
 - a. Master schedule
 - b. Bill of materials
 - c. Inventory records
 - d. Gross requirements
 - e. Net requirements
 - f. Time-phased plan
 4. How is safety stock included in a material requirements plan?
 5. What factors can create safety stock requirements in an MRP system?
 6. What is meant by the term *safety time*?
 7. Contrast *net-change* systems and *regenerative* systems for MRP.
 8. Briefly discuss the requirements for effective MRP.
 9. What are some of the main advantages and limitations of MRP?
 10. How can the use of MRP contribute to productivity?
 11. Briefly describe MRP II and closed-loop MRP.
 12. What is lot sizing, what is its goal, and why is it an issue with lumpy demand?
 13. Contrast planned-order receipts and scheduled receipts.
 14. If seasonal variations are present, is their incorporation into MRP fairly simple or fairly difficult? Explain briefly.
 15. How does the purpose of ERP differ from the purpose of MRP II?
 16. What are some unforeseen costs of ERP?
-
1. What trade-offs are involved in the decision to purchase an ERP software package?
 2. Who in the organization needs to be involved in designing and implementing MRP II? Who needs to be involved in the decision to purchase an ERP system? Who needs to be trained to use ERP?
 3. To what extent has technology such as ERP software improved the ability to manage a business organization? How important are each of the following considerations?
 - a. Ease of use
 - b. Complete integration
 - c. Reliability

DISCUSSION AND REVIEW QUESTIONS

TAKING STOCK

CRITICAL THINKING EXERCISES

- Suppose you work for a furniture manufacturer, one of whose products is the chair depicted in Figure 13.5. Finished goods inventory is held in a central warehouse in anticipation of customer orders. Finished goods are controlled using EOQ/ROP methods. The warehouse manager, Juan Villa, has suggested using the same methods for controlling component inventory. Write him a brief memo outlining your opinion on doing that.
- Give one example of unethical behavior involving MRP and one involving ERP, and state the ethical principle violated for each example.

PROBLEMS

- Given the following diagram for a product, determine the quantity of each component required to assemble one unit of the finished product.

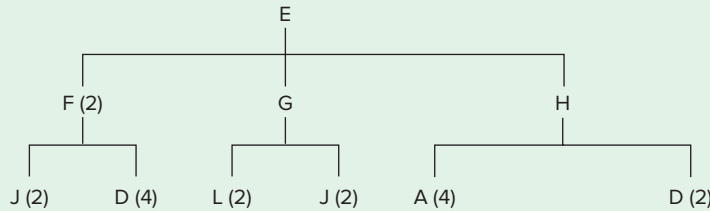

- Draw a tree diagram for a stapler, given the following bill of materials:

Item	Components
Stapler	Top assembly, base assembly
Top assembly	Cover, spring, slide assembly
Cover	
Spring	
Slide assembly	Slide, spring
Slide	
Spring	
Base assembly	Base, strike plate, rubber pad (2)
Base	
Strike plate	
Rubber pad (2)	

- The following table lists the components needed to assemble an end item, lead times, and quantities on hand.

Item	End	B	C	D	E	F	G	H
LT (wk)	1	2	3	3	1	2	1	2
Amount on hand	0	10	10	25	12	30	5	0

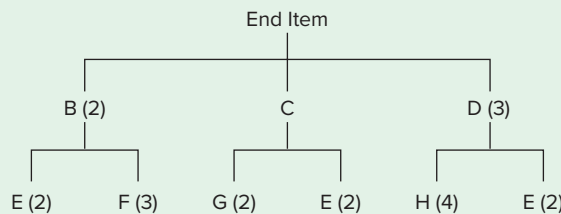

- If 20 units of the end item are to be assembled, how many additional units of E are needed? (*Hint: You don't need to develop an MRP plan to determine this.*)
 - An order for the end item is scheduled to be shipped at the start of week 11. What is the latest week that the order can be started and still be ready to ship on time? (*Hint: You don't need to develop an MRP plan for this part either.*)
- The following table lists the components needed to assemble an end item, lead times (in weeks), and quantities on hand.

Item	Lead Time	Amount on Hand	Direct Components
End	1	—	L(2), C(1), K(3)
L	2	10	B(2), J(3)
C	3	15	G(2), B(2)
K	3	20	H(4), B(2)
B	2	30	
J	3	30	
G	3	5	
H	2	—	

- a. If 40 units of the end item are to be assembled, how many additional units of B are needed? (*Hint: You don't need to develop an MRP plan.*)
 - b. An order for the end item is scheduled to be shipped at the start of week 8. What is the latest week that the order can be started and still be ready to ship on time? (*Hint: You don't need to develop an MRP plan.*)
4. Eighty units of end item E are needed at the beginning of week 6. Three cases (30 units per case) of J have been ordered and one case is scheduled to arrive in week 3, one in week 4, and one in week 5. *Note: J must be ordered by the case, and B must be produced in multiples of 120 units. There are 60 units of B and 20 units of J now on hand. Lead times are two weeks each for E and B, and one week for J.*

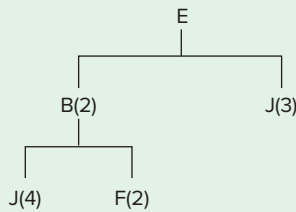

- a. Prepare a material requirements plan for component J.
 - b. Suppose that in week 4 the quantity of E needed is changed from 80 to 70. The planned-order releases through week 3 have all been executed. How many more Bs and Js will be on hand in week 6?
5. a. One hundred twenty units of end item Z are needed at the beginning of week 7. Prepare a material requirements plan for component C. Take into account that on hand there are 40 units of Z, 70 units of A, 100 units of B, and 30 units of C. Also, there is a scheduled receipt of 20 units of component C in week 4. Lead times are two weeks for Z and B, and one week for the other components. Lot-for-lot ordering will be used for all items.

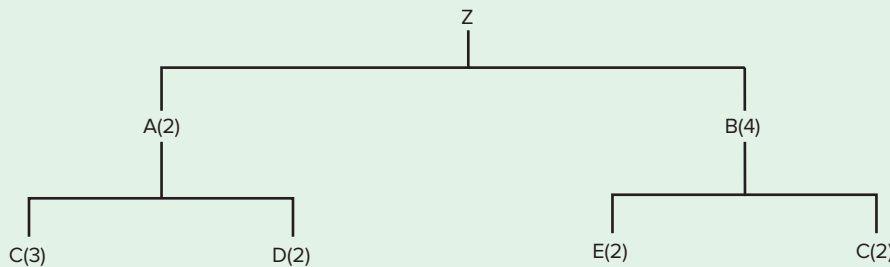

- b. Ninety-five units of end item E are needed at the beginning of week 7. Prepare a material requirements plan for component D. Take into account that 5 units of E are currently on hand, as well as 50 units of B, 100 units of C, and 80 units of D. Also, 30 units of C have been outsourced and are expected to arrive in week 4. Lead times are two weeks for E and C, and one week for the other components. Assume lot-for-lot ordering except for D, where multiples of 40 must be used.

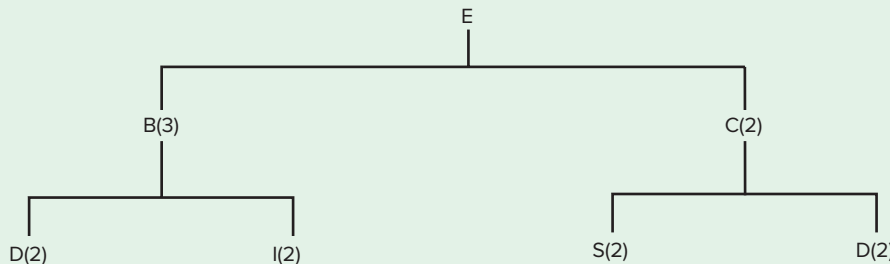

6. A table is assembled using three components, as shown in the accompanying product structure tree. The company that makes the table wants to ship 100 units at the beginning of day 4, 150 units at the beginning of day 5, and 200 units at the beginning of day 7. Receipts of 100 wood sections are scheduled at the beginning of day 2. There are 120 legs on hand, and 60 braces on hand. Lead times (in days) for all items are shown in the following table. Prepare a material requirements plan using lot-for-lot ordering.

Quantity	Lead Time
1–200	1
201–550	2
551–999	3

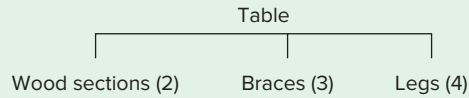

7. Eighty units of end item X are needed at the beginning of week 6, and another 30 units are needed at the beginning of week 8. Prepare a material requirements plan for component D. D can only be ordered in whole cases (50 units per case). One case of D is automatically received every other week, beginning in week 1 (i.e., weeks 1, 3, 5, 7). Lot-for-lot ordering will be used for all items except D. Also, there are 30 units of B and 20 units of D now on hand. Lead times for all items are a function of quantity: one week for up to 100 units, two weeks for 101 to 200 units, three weeks for 201 to 300 units, and four weeks for 301 or more units.

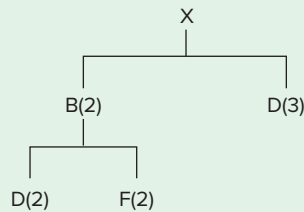

8. Oh No!, Inc., sells three models of radar detector units. It buys the three basic models (E, F, and G) from a Japanese manufacturer and adds one, two, or four lights (component D) to further differentiate the models. D is bought from a domestic producer.

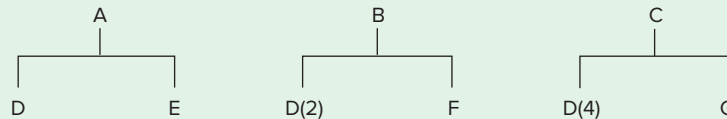

Lead times are one week for all items except C, which is two weeks. There are ample supplies of the basic units (E, F, and G) on hand. There are also 10 units of B, 10 units of C, and 25 units of D on hand. Lot-sizing rules are lot-for-lot ordering for all items except D, which must be ordered in multiples of 100 units. There is a scheduled receipt of 100 units of D in week 1.

The master schedule calls for 40 units of A in week 4, 60 units of B in week 5, and 30 units of C in week 6. Prepare a material requirements plan for D and its parents.

9. Assume you are the manager of a shop that assembles power tools. You have just received an order for 50 chain saws, which are to be shipped at the start of week 8. Pertinent information on the saws follows:

Item	Lead Time (weeks)	On Hand	Components
Saw	2	15	A(2), B(1), C(4)
A	1	10	E(3), D(1)
B	2	5	D(2), F(3)
C	2	65	E(2), D(2)
D	1	20	
E	1	10	
F	2	30	

- Develop a product structure tree, an assembly time chart, and a master schedule.
- Develop the material requirements plan for component E using lot-for-lot ordering for all items.

10. Assume you are the manager of Assembly, Inc. You have just received an order for 40 units of an industrial robot, which is to be delivered at the start of week 7 of your schedule. Using the following information, determine how many units of subassembly G to order and the timing of those orders, given that subassembly G must be ordered in multiples of 80 units and all other components are ordered lot-for-lot. Assume that the components are used only for this particular robot.

Item	Lead Time (weeks)	On Hand	Components
Robot	2	10	B, G, C(3)
B	1	5	E, F
C	1	20	G(2), H
E	2	4	—
F	3	8	—
G	2	15	—
H	1	10	—

11. Determine material requirements plans for parts N and V and subassembly I as described in Solved Problem 3 for each of the following:
- Assume there are currently 100 Ns on hand, and scheduled receipts of 40 Is and 10 Vs at the beginning of week 3. No Es are on hand; 120 Es are needed at the start of week 5.
 - Assume on-hand and scheduled receipts as in part *a*. Now suppose that 100 Es are needed at the start of week 5, and 55 are needed at the start of week 7. Also, use multiples of these order sizes: N, 800; V, 200. Use lot-for-lot ordering for I.
 - Using your answer to part *b*, update the MRP for V, using the following additional information for each of these cases: (1) one week has elapsed (making it the start of week 2), and (2) three weeks have elapsed (making it the start of week 4).
The updated master schedule now has an order for 100 units of E in week 9. Your plan should cover weeks 2 through 9 for case 1, and weeks 4 through 11 for case 2. Assume all orders are released and received as planned.
12. A firm that produces electric golf carts has just received an order for 200 carts, which must be ready for delivery at the start of week 8. Information concerning the product structure, lead times, and quantities on hand is shown in the following table. Use this information to do each of the following:

Parts List for Electric Golf Cart	Lead Time	Quantity on Hand
Electric golf cart	1	0
Top	1	40
Supports (4)	1	200
Cover	1	0
Base	1	20
Motor	2	300
Body	3	50
Frame	1	35
Controls	1	0
Wheel assemblies (4)	1	240
Seats (2)	2	120

13. Refer to Problem 12. Assume that unusually mild weather has caused a change in the quantity and timing of orders for golf carts. The revised plan calls for 100 golf carts at the start of week 6, 100 at the start of week 8, and 100 at the start of week 9.
- Develop a master schedule for this revised plan.
 - Determine the timing and quantities for orders for tops and bases.
 - Assume that equipment problems reduce the firm's capacity for assembling bases to 50 units per week. Revise your material plan for bases to reflect this, but still meet delivery dates.

14. Using the accompanying diagram, do the following:
- Draw a tree diagram for the scissors.
 - Prepare an MRP plan for scissors. Lead times are one day for each component and final scissors assembly, but two days for the plastic grips. Six hundred pairs of scissors are needed on day 6.
Note: There are 200 straight blades and 350 bent blades on hand, and 40 top blade assemblies on hand.
Use lot-for-lot ordering for all items.

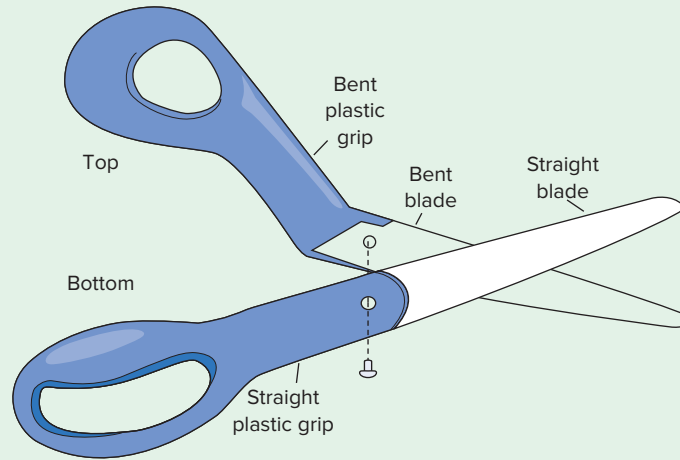

15. A company that manufactures paving material for driveways and parking lots expects the following demand for its product for the next four weeks.

Week number	1	2	3	4
Material (tons)	40	80	60	70

The company’s labor and machine standards and available capacities are as follows.

	Labor	Machine
Production standard (hours per ton)	4	3
Weekly production capacity (hours)	300	200

- Determine the capacity utilization for labor and machine for each of the four weeks.
 - In which weeks do you foresee a problem? What options would you suggest to resolve any problems? What costs are relevant in making a decision on choosing an option?
16. A company produces two very similar products that go through a three-step sequence of fabrication, assembly, and packaging. Each step requires one day for a lot to be completely processed and moved to the next department. Processing requirements for the departments (hours per unit) are as follows.

Product	FABRICATION		ASSEMBLY		PACKAGING	
	Labor	Machine	Labor	Machine	Labor	Machine
A	2	1	1.5	1	1	.5
B	1	1	1	1	1.5	.5

Department capacities are all 700 hours of labor and 500 hours of machine time, except Friday, when capacities are 200 hours for both labor and machine time. The following production schedule is for next week.

Product	Mon	Tues	Wed	Thurs	Fri
A	200	400	100	300	100
B	300	200	200	200	200

- Determine the labor and machine capacity requirements for each product and the total load for each department for each day. Ignore changeover time.
- Evaluate the projected loading for the first three days of the week. Is the schedule feasible? What do you suggest for balancing the load?

17. The MRP Department has a problem. Its computer “died” just as it spit out the following information: Planned order release for item J27 = 640 units in week 2. The firm has been able to reconstruct all the information they lost except the master schedule for end item 565. The firm is fortunate because J27 is used only in 565s. Given the following product structure tree and associated inventory status record information, determine what master schedule entry for 565 was exploded into the material requirements plan that killed the computer.

Part Number	On Hand	Lot Size	Lead Time
565	0	Lot-for-lot	1 week
X43	60	Multiples of 120	1 week
N78	0	Lot-for-lot	2 weeks
Y36	200	Lot-for-lot	1 week
J27	0	Lot-for-lot	2 weeks

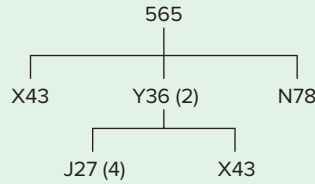

18. Develop a material requirements plan for component H. Lead times for the end item and each component except B are one week. The lead time for B is three weeks. Sixty units of A are needed at the start of week 8. There are currently 15 units of B on hand and 130 of E on hand, and 50 units of H are in production and will be completed by the start of week 2. Lot-for-lot ordering will be used for all items.

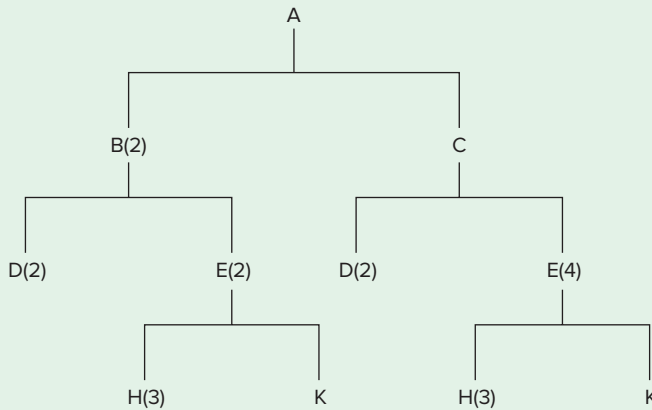

CASE PROMOTIONAL NOVELTIES

Promotional Novelties provides a wide range of novelty items for its corporate customers. It has just received an order for 20,000 toy tractor-trailers that will be sold by a regional filling station company as part of a holiday promotion. The order is to be shipped at the beginning of week 8. The tree diagram shows the various components of the trucks.

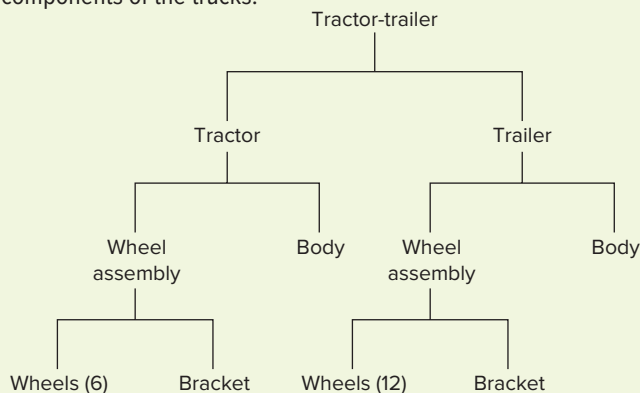

The company can complete final assembly of the tractor-trailers at the rate of 10,000 a week. The tractor and trailer bodies are purchased; lead time is three weeks. The wheels are the manager’s main concern.

The company has a sufficient supply of brackets on hand. Assembly time is one week each for tractors, trailers, and wheel assembly. However, the wheel department can only produce wheels at the rate of 100,000 a week. The manager plans to use the wheel department to full capacity, starting in week 2 of the schedule, and order additional wheels from a supplier as needed. Ordered wheels come in sets of 6,400. The lead time for delivery from the supplier is expected to be two to three weeks. Use lot-for-lot ordering for all items except the purchased wheels.

Questions

1. How many wheel sets should the manager order?
2. When should the wheel sets be ordered?



After the dot-com business he tried to start folded, David “Marty” Dawkins decided to pursue his boyhood dream of owning a bike factory. After several false starts, he finally got the small company up and running. The company currently assembles two models Marty designed: the Arrow and the Dart. The company hasn’t turned a profit yet, but Marty feels that once he resolves some of the problems he’s having with inventory and scheduling, he can increase productivity and reduce costs.

At first, he ordered enough bike parts and subassemblies for four months’ worth of production. Parts were stacked all over the place, seriously reducing work space and hampering movement of workers and materials. And no one knew exactly where anything was. In Marty’s words, “It was a solid mess!”

He and his two partners eventually managed to work off most of the inventory. They hope to avoid similar problems in the future by using a more orderly approach. Marty’s first priority is to develop a materials requirement plan for upcoming periods. He wants to assemble 15 Arrows and 10 Darts each week, to have them ready at the start of weeks 4 through 8. The product structure trees for the two bikes follow.

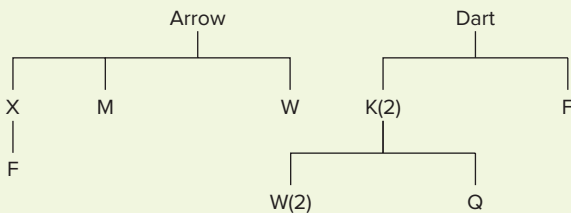

One of Marty’s partners, Ann, has organized information on lead times, inventory on hand, and lot-sizing rules (established by suppliers):

Item	Lead Time (weeks)	On Hand	Lot-Sizing Rule
Arrow	2	5	Lot-for-lot
Dart	2	2	Lot-for-lot
X	1	5	Multiples of 25
W	2*	2	Multiples of 12
F	1	10	Multiples of 30
K	1	3	Lot-for-lot
Q	1	15	Multiples of 30
M	1	0	Lot-for-lot

*LT = 3 weeks for orders of 36 or more units on this item

Scheduled receipts are:

- Period 1: 20 Arrows and 18 Ws
- Period 2: 20 Darts and 15 Fs

As the third partner, it is your job to develop the material requirements plan.



Introduction

www.stickley.com

L. & J.G. Stickley was founded in 1900 by brothers Leopold and George Stickley. Located just outside of Syracuse, New York, the company is a producer of fine cherry, white oak, and mahogany furniture. In the 1980s, the company reintroduced the company’s original line of mission oak furniture, which now accounts for nearly 50 percent of the company’s sales.

Over the years, the company experienced both good and bad times, and at one point it employed over 200 people. However, by the early 1970s, the business was in disarray; there were only about 20 full-time employees, and the company was on the brink of bankruptcy. The present owners bought the ailing firm in 1974, and under their leadership, the company has prospered and grown, and now has 1,350 employees. Stickley has five retail showrooms

in New York State, two in Connecticut, one in North Carolina, and its furniture is sold nationally by some 120 dealers.

Production

The production facility is a large, rectangular building with a 30-foot ceiling. Furniture making is labor intensive, although saws, sanders, and other equipment are very much a part of the process. In fact, electric costs average about \$60,000 a month. The company has its own tool room where cutting tools are sharpened, and replacement parts are produced as needed.

Worker skills range from low-skilled material handlers to highly skilled craftsmen. For example, seven master cabinet makers handle customized orders.

The process (see figure below) begins with various sawing operations where large boards received from the lumber mills are cut into smaller sizes. The company recently purchased a



John Mutrux/Kansas City Star/MCT/Getty Images

computer-controlled “optimizer” saw that greatly improves sawing productivity, and eliminates some waste. Workers inspect and mark knot locations and other defects they find on each piece of lumber before feeding it into the saw. The computer then determines the optimal set of cuttings, given the location of knots and other defects, and standard lengths needed for subsequent operations. Approximately 20,000 board feet are cut each day. Subsequent sawing operations provide additional cuts for specific jobs.

Workers then glue some of the pieces together; they will end up as tops of tables, desks, dressers, or a similar item. Large presses hold 20 to 30 glued sections at a time. Other pieces that will become table or chair legs, chair backs, or other items go through various shaping operations. Next comes a series of sanding operations, which remove excess glue from the glued sections and smooth the surface of both glued pieces and other pieces.

Some of the pieces may require drilling or mortising, an operation in which rectangular holes and other shapes are cut into the wood. The company has a CNC (numerically controlled) router that can be programmed to make grooves and other specialty cuts. Some items require carving, which involves highly skilled workers.

Next, workers assemble the various components, either into subassemblies, or sometimes directly to other components to obtain completed pieces. Each item is stamped with the date of production, and components such as dresser drawers, cabinet doors, and expansion leaves of tables also are stamped to identify their location (e.g., top drawer, left door). Careful records are kept so that if a piece of furniture is ever returned for repairs, complete instructions are available (type of wood, finish, etc.) to enable repair people to closely match the original piece.

The furniture items then usually move to the “white inventory” (unfinished) section, and eventually to the finishing department where workers apply linseed oil or another finish before the items

are moved to the finished goods inventory to await shipment to stores or customers.

The company uses a level production plan (maintain steady output and steady labor force). Demand is seasonal; it is highest in the first and third quarters. During the second and fourth quarters, excess output goes into inventory; during the first and third quarters, excess demand is met using inventory. The production scheduler uses a schedule that is set for the next 8 to 10 weeks.

Production Control

Job sequence is determined by the amount of remaining inventory (days’ supply on hand), and processing time. Lot sizes are determined by factoring in demand, setup costs, and carrying costs. Typical lot sizes are 25 to 60 pieces. There are many jobs being done concurrently. Each job is accompanied by a set of bar codes that identify the job and the operation. As each operation is completed, the operator removes a bar-code sticker and delivers it to the scheduling office where it is scanned into the computer, thereby enabling production control to keep track of progress on a job, and to know its location in the shop.

The company’s policy of level output coupled with seasonal demand patterns means that prior to peak demand periods, excess output is used to build up inventories, which is then drawn down when demand exceeds production capacity during periods of peak production.

Inventory

In addition to the “white” inventory and a small finished goods inventory, the company maintains an inventory of furniture pieces (e.g., table and chair legs) and partially assembled items. This inventory serves two important functions. One is to reduce the amount of time needed to respond to customer orders rather than

(continued)

(concluded)

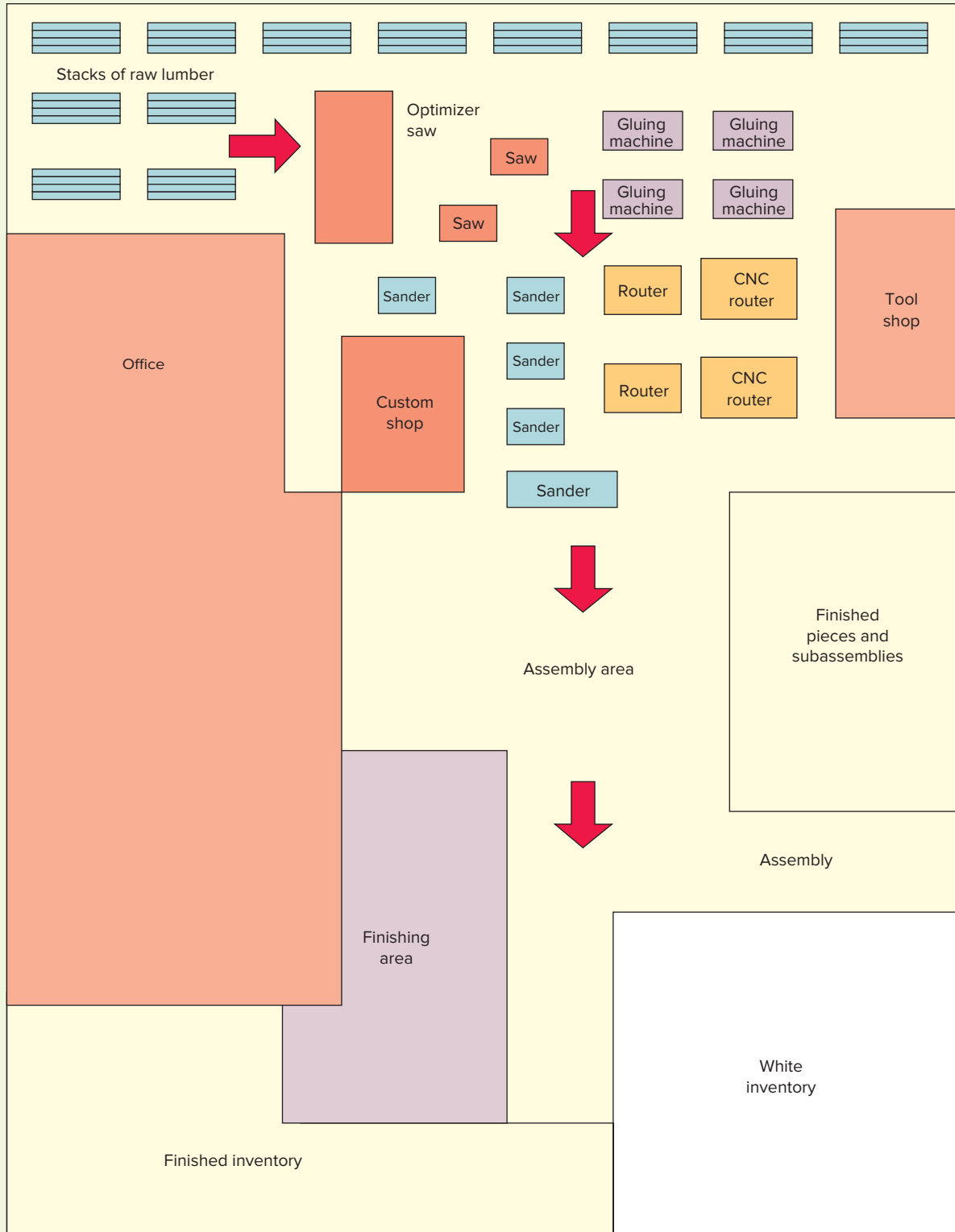

having to go through the entire production process to obtain needed items, and the other is that it helps to smooth production and utilize idle machinery/workers. Because of unequal job times on successive operations, some workstations invariably have slack time, while others work at capacity. This is used to

build an inventory of commonly used pieces and subassemblies. Moreover, because pieces are being made for inventory, there is flexibility in sequencing. This permits jobs that have similar setups to be produced in sequence, thereby reducing setup time and cost.

Quality

Each worker is responsible for checking his or her quality, as well as the quality of materials received from preceding operations, and to report any deficiencies. In addition, on several difficult operations, quality control people handle inspections and work with operators to correct any deficiencies. The company is considering a TQM approach, but has not yet made a decision on whether to go in that direction.

Questions

1. Which type of production processing—job shop, batch, repetitive, or continuous—is the primary mode of operation at Stickley Furniture? Why? What other type of processing is used to a lesser extent? Explain.
2. How does management keep track of job status and location during production?
3. Suppose the company has just received an order for 40 mission oak dining room sets. Briefly list the kinds of information the company will need to plan, schedule, and process this job.
4. What benefits and what problems would you expect given the company's level production policy?
5. Can you suggest any changes that might be beneficial to the company?

Hopp, Wallace, and Mark L. Spearman. *Factory Physics*, 3rd ed. New York: Irwin/McGraw-Hill, 2007.

Jacobs, F. Robert, William L. Berry, D. Clay Whybark, and Thomas E. Vollman. *Manufacturing Planning and Control for Supply Chain Management*, 6th ed. Burr Ridge, IL: McGraw-Hill/Irwin, 2011.

Pound, Edward, Jeffery H. Bell, and Mark L. Spearman. *Factory Physics for Managers: How Leaders Improve Performance in a Post-lean, Six Sigma World*. New York: McGraw-Hill, 2016.

Wagner, Brett, and Ellen Monk. *Enterprise Resource Planning*, 3rd ed. Boston, MA: Cengage Learning, 2008.

**SELECTED
BIBLIOGRAPHY AND
FURTHER READINGS**

14

JIT and Lean Operations

CHAPTER

LEARNING OBJECTIVES

After completing this chapter, you should be able to:

- LO14.1** Explain the terms *lean operations* and *JIT*.
- LO14.2** Describe the main characteristics of lean systems.
- LO14.3** List the five principles of how lean systems function.
- LO14.4** List some of the benefits and some of the risks of lean operation.
- LO14.5** Describe the Toyota Production System (TPS).
- LO14.6** List the three goals of a lean system and explain the importance of each.
- LO14.7** List the eight wastes according to lean philosophy.
- LO14.8** Identify and briefly discuss the four building blocks of a lean production system.
- LO14.9** Describe key lean improvement tools.
- LO14.10** Outline considerations for successful conversion from a traditional system to a lean system.
- LO14.11** Describe some of the obstacles to lean success.

CHAPTER OUTLINE

- | | | |
|--|--|--------------------------------------|
| 14.1 Introduction 612 | Manufacturing Planning and Control 624 | Planning a Successful Conversion 635 |
| Characteristics of Lean Systems 612 | 14.4 Lean Tools 632 | Obstacles to Conversion 636 |
| Benefits and Risks of Lean Systems 613 | Value Stream Mapping 632 | A Cooperative Spirit 636 |
| The Toyota Approach 613 | Process Improvement Using 5W2H 634 | 14.6 Lean Services 637 |
| 14.2 Supporting Goals 615 | Lean and Six Sigma 634 | 14.7 JIT II 638 |
| 14.3 Building Blocks 616 | JIT Deliveries and the Supply Chain 634 | 14.8 Operations Strategy 638 |
| Product Design 616 | Lean and ERP 634 | Case: Level Operations 643 |
| Process Design 617 | 14.5 Transitioning to a Lean System 635 | Operations Tour: Boeing 644 |
| Personnel/Organizational Elements 622 | | Supplement: Maintenance 646 |



Lennox McLendon/AP Images

As business organizations strive to maintain competitiveness in an ever-changing global economy, they are increasingly seeking new and better ways of operating. For some, this means changing from the traditional ways of operating to what is now referred to as lean operation. A **lean operation** is a flexible system of operation that uses considerably fewer resources (i.e., activities, people, inventory, and floor space) than a traditional system. Moreover, lean systems tend to achieve greater productivity, lower costs, shorter cycle times, and higher quality than nonlean systems.

Lean systems are sometimes referred to as **just-in-time (JIT)** systems owing to their highly coordinated activities and delivery of goods that occur just as they are needed. The lean approach was pioneered by Toyota's founder, Taiichi Ohno, and Shigeo Shingo as a much faster and less costly way of producing automobiles. Following its success, today the lean approach is being applied to a wide range of manufacturing and service operations.

Lean is both a philosophy and a methodology that focuses on eliminating waste (non-value-added activities) and streamlining operations by closely coordinating all activities. Lean systems have three basic elements: They are demand-driven, are focused on waste reduction, and have a culture that is dedicated to excellence and continuous improvement.

Lean operation A flexible system that uses minimal resources and produces high-quality goods or services.

Just-in-time (JIT) A highly coordinated processing system in which goods move through the system, and services are performed, just as they are needed.

continued

This chapter describes the lean production approach, including the basic elements of these systems and what it takes to make them work effectively. It also points out the benefits of these systems and the potential obstacles that companies may encounter when they attempt to convert from a traditional system to a lean production system.

14.1 INTRODUCTION

LO14.1 Explain the terms *lean operations* and *JIT*.

Lean operations began as lean manufacturing in the mid-1900s. It was developed by the Japanese automobile manufacturer Toyota. The development in Japan was influenced by the limited resources available at the time. Not surprisingly, the Japanese were very sensitive to waste and inefficiency. Widespread interest in lean manufacturing occurred after a book about automobile production, *The Machine That Changed the World*, by James Womack, Daniel Jones, and Daniel Roos, was published in 1990. As described in the book, Toyota's focus was on the elimination of all waste from every aspect of the process. Waste was defined as anything that interfered with, or did not add value to, the process of producing automobiles.

A stunning example of the potential of lean manufacturing was illustrated by the successful adoption of lean methods in the mid-1980s in a Fremont, California, auto plant. The plant was originally operated by General Motors (GM). However, GM closed the plant in 1982 because of its low productivity and high absenteeism. A few years later, the plant was reopened as a joint venture of Toyota and GM, called NUMMI (New United Motor Manufacturing, Inc.). About 80 percent of the former plant workers were rehired, but the white-collar jobs were shifted from directing to supporting workers, and small teams were formed and trained to design, measure, and improve their performance. The result? By 1985 productivity and quality improved dramatically, exceeding all other GM plants, and absenteeism was negligible.

As other North American companies attempted to adopt the lean approach, they began to realize that in order to be successful, they needed to make major organizational and cultural changes. They also recognized that mass production, which emphasizes the efficiency of individual operations and leads to unbalanced systems and large inventories, was outmoded. Instead, they discovered that lean methods involve demand-based operations, flexible operations with rapid changeover capability, effective worker behaviors, and continuous improvement efforts.

LO14.2 Describe the main characteristics of lean systems.

Characteristics of Lean Systems

A number of characteristics are commonly found in lean systems. An overview of these will provide a better understanding of lean systems.

Waste reduction—A hallmark of lean systems

Continuous improvement—Another hallmark; never-ending efforts to improve

Use of teams—Cross-functional teams, especially for process improvement

Work cells—Along with cellular layouts, they allow for better communication and use of people

Visual controls—Simple signals that enable efficient flow and quick assessment of operations

High quality—In suppliers' parts, in processes, and in output

Minimal inventory—Excess inventory is viewed as a waste

Output tied to demand—Throughout the entire system; referred to as "demand pull"

Quick changeovers—Enables equipment flexibility and output variety without disruption

Small lot sizes—Enables variety for batch production

Lean culture—The entire organization embraces lean concepts and strives to achieve them

Five principles embody the way lean systems function. Note the connections to the preceding characteristics.

- Identify customer values.
- Focus on processes that create value.
- Eliminate waste to create “flow.”
- Produce only according to customer demand.
- Strive for perfection.

LO14.3 List the five principles of how lean systems function.

Benefits and Risks of Lean Systems

Lean systems offer numerous benefits, but carry some risks. The key benefits include:

- Reduced waste due to emphasis on waste reduction.
- Lower costs due to reduced waste and lower inventories.
- Increased quality motivated by customer focus and the need for high-quality processes.
- Reduced cycle time due to elimination of non-value-added operations.
- Increased flexibility due to quick changeovers and small lot sizes.
- Increased productivity due to elimination of non-value-added processes.

LO14.4 List some of the benefits and some of the risks of lean operation.

Certain risks also often accompany lean operations, such as:

- Increased stress on workers due to increased responsibilities for equipment changeovers, problem solving, and process and quality improvement.
- Fewer resources (e.g., inventory, people, time) available if problems occur.
- Supply chain disruptions can halt operations due to minimal inventory or time buffers.

John Deere, the well-known tractor supply company, bolstered profits during a recession by using a JIT approach to reduce inventory levels. However, when demand picked up as the economy strengthened, a shortage of parts led to stretched-out delivery dates. Long lead times to replenish parts meant that, in some cases, harvesting equipment that farmers wanted wouldn't be available until *after* harvest time! As a result, some farmers turned to Deere's competitors to purchase needed equipment.

The Toyota Approach

Many of the methods common to lean operations were developed as part of Japanese car maker Toyota's approach to manufacturing. Toyota's system came to be known as the Toyota Production System (TPS), and it has served as a model for many implementations of lean systems, particularly in manufacturing. Many of the terms Toyota employed are now commonly used in conjunction with lean operations, especially the following.

- **Muda:** Waste and inefficiency. Perhaps the driving philosophy. Waste and inefficiency can be minimized by using the following tactics.
- **Kanban:** A manual system used for controlling the movement of parts and materials that responds to *signals* of the need (i.e., demand) for delivery of parts or materials. This applies both to delivery to the factory and delivery to each workstation. The result is the delivery of a steady stream of containers of parts throughout the workday. Each container holds a small supply of parts or materials. New containers are delivered to replace empty containers.
- **Heijunka:** Variations in production volume lead to waste. The workload must be leveled; volume and variety must be averaged to achieve a steady flow of work.
- **Kaizen:** Continuous improvement of the system. There is always room for improvement, so this effort must be ongoing.
- **Jidoka:** Quality at the source. A machine automatically stops when it detects a bad part. A worker then stops the line. Also known as *autonomation*.

LO14.5 Describe the Toyota Production System (TPS).

Muda Waste and inefficiency.

Kanban A manual system that signals the need for parts or materials.

Heijunka Workload leveling.

Kaizen Japanese term for continuous improvement.

Jidoka Quality at the source (autonomation).



In recent years, Toyota has been plagued by more than a few recalls of its popular vehicles. This was somewhat surprising, given Toyota's reputation as a world leader in quality and lean production. Various news reports pointed to the following as possible

causes: overdoing its quest for cost reduction; failure to heed early reports of problems and address them, possibly due to a refusal to admit there were problems; and increased difficulty in overseeing the entire system from Japan as overseas sales expanded.

In some respects, the just-in-time concept was operational over 60 years ago at Henry Ford's great industrial complex in River Rouge, Michigan.

Toyota learned a great deal from studying Ford's operations and based its lean approach on what it saw. However, Toyota was able to accomplish something that Ford couldn't—a system that could handle some variety.

A widely held view of JIT/lean production is that it is simply a system for scheduling production that results in low levels of work-in-process and inventory. But in its truest sense, JIT/lean production represents a *philosophy* that encompasses every aspect of the process, from design to after the sale of a product. The philosophy is to pursue a system that functions well with minimal levels of inventories, minimal waste, minimal space, and minimal transactions. Truly, a *lean* system. As such, it must be a system that is not prone to disruptions and is flexible in terms of the product variety and range of volume it can handle.

In lean systems, quality is ingrained in both the product and the process. Companies that use lean operations have achieved a level of quality that enables them to function with small batch sizes and tight schedules. Lean systems have high reliability; major sources of inefficiency and disruption have been eliminated, and workers have been trained not only to function in the system but also to continuously improve it.

The ultimate goal of a lean operation is to achieve a system that matches supply to customer demand; supply is synchronized to meet customer demand in a smooth, uninterrupted flow. Figure 14.1 provides an overview of the goals and building blocks of a lean production system. The following pages provide more details about the supporting goals and building blocks.

In the mid-1920s, the Ford assembly plant in River Rouge, Michigan, was a state-of-the-art industrial complex employing over 75,000 workers. In 1982, Eiji Toyoda, head of the Toyota Company, toasted Ford's then-president Philip Caldwell, saying, "There is no secret to how we learned to do what we do—we learned it at the Rouge."

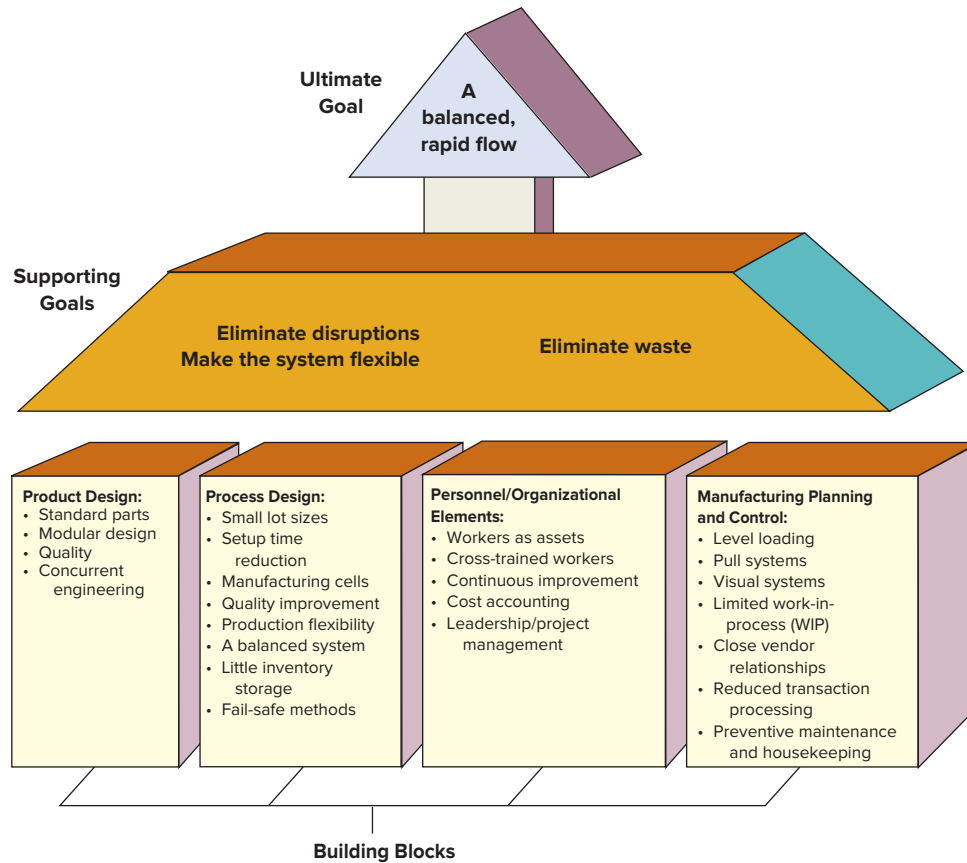

Keystone-France/Gamma-Keystone/Getty Images

**FIGURE 14.1**

An overview of the goals and building blocks of lean production systems

Source: Adapted from Thomas E. Vollmann, William L. Berry, and D. Clay Whybark, *Manufacturing Planning and Control Systems*, 5th ed. Copyright 2005 Irwin/ McGraw-Hill Companies, Inc. Used with permission.

14.2 SUPPORTING GOALS

The ultimate goal of lean is a *balanced* system—that is, one that achieves a smooth, rapid flow of materials and/or work through the system. The idea is to make the process time as short as possible by using resources in the best possible way. The degree to which the overall goal is achieved depends on how well certain supporting goals are achieved. Those goals are to:

- Eliminate disruptions
- Make the system flexible
- Eliminate waste, especially excess inventory

Disruptions have a negative influence on the system by upsetting the smooth flow of products through the system, and they should be eliminated. Disruptions are caused by a variety of factors, such as poor quality, equipment breakdowns, changes to the schedule, and late deliveries. Quality problems are particularly disruptive because in lean systems there is no extra inventory that can be used to replace defective items. All disruptions should be eliminated where possible. This will reduce the uncertainty that the system must deal with.

A *flexible system* is one that is robust enough to handle a mix of products, often on a daily basis, and to handle changes in the level of output while still maintaining balance and throughput speed. This enables the system to deal with some uncertainty. Long setup times and long lead times negatively impact the flexibility of the system. Hence, reduction of setup and lead times is very important in a lean system.

Waste represents unproductive resources; eliminating waste can free up resources and enhance production. *Inventory* is an idle resource, taking up space and adding cost to the system. It should be minimized as much as possible. In the lean philosophy, there are eight wastes (*muda*):

1. **Excess inventory**—Beyond minimal quantities, an idle resource takes up floor space and adds to cost

LO14.6 List the three goals of a lean system and explain the importance of each.

LO14.7 List the eight wastes according to lean philosophy.

2. **Overproduction**—Involves excessive use of manufacturing resources
3. **Waiting time**—Requires space, adds no value
4. **Unnecessary transporting**—Increases handling, increases work-in-process inventory
5. **Processing waste**—Makes unnecessary production steps, scrap
6. **Inefficient work methods**—Reduce productivity, increase scrap, increase work-in-process inventory
7. **Product defects**—Require rework costs and possible lost sales due to customer dissatisfaction
8. **Underused people**—Relates to mental and creative abilities, as well as physical abilities

The existence of these wastes is an indication that improvement is possible. The list of wastes also can identify potential targets for continuous improvement efforts.

The *kaizen* philosophy for eliminating waste is based on the following tenets:¹

1. Waste is the enemy, and to eliminate waste it is sometimes necessary to get “hands dirty.”
2. Improvement should be done gradually and continuously; the goal is not big improvements done intermittently.
3. Everyone should be involved—top managers, middle managers, and workers.
4. *Kaizen* is built on a cheap strategy, and it does not require spending great sums on technology or consultants.
5. It can be applied anywhere.
6. It is supported by a visual system: a total transparency of procedures, processes, and values, making problems and wastes visible to all.
7. It focuses attention where value is created.
8. It is process oriented.
9. It stresses that the main effort of improvement should come from new thinking and a new work style.
10. The essence of organizational learning is to learn while doing.

14.3 BUILDING BLOCKS

LO14.8 Identify and briefly discuss the four building blocks of a lean production system.

The design and operation of a lean system provide the foundation for accomplishing the aforementioned goals. As shown in Figure 14.1, the building blocks are:

- Product design
- Process design
- Personnel/organizational elements
- Manufacturing planning and control

Speed and simplicity are two common threads that run through these building blocks.

Product Design

Four elements of product design are important for a lean production system:

- Standard parts
- Modular design
- Highly capable production systems with quality built in
- Concurrent engineering

The first two elements relate to speed and simplicity.

¹Adapted from Jorge Nascimento Rodrigues with Masaaki Imai, “Masaaki Imai: The Father of Kaizen,” www.gursonline.tv/uk/conteudos/imai.asp.

The use of *standard parts* means that workers have fewer parts to deal with, and training times and costs are reduced. Purchasing, handling, and checking quality are more routine and lend themselves to continual improvement. Another important benefit is the ability to use standard processing.

Modular design is an extension of standard parts. Modules are clusters of parts treated as a single unit. This greatly reduces the number of parts to deal with, simplifying assembly, purchasing, handling, training, and so on. Standardization has the added benefit of reducing the number of different parts contained in the bill of materials for various products, thereby simplifying them.

Lean requires highly capable production systems. Quality is the sine qua non (“without which not”) of lean. It is crucial to lean systems because poor quality can create major disruptions. Quality must be embedded in goods and processes. The systems are geared to a smooth flow of work; the occurrence of problems due to poor quality creates disruption in this flow. Because of small lot sizes and the absence of buffer stock, production must cease when problems occur, and it cannot resume until the problems have been resolved. Obviously, shutting down an entire process is costly and cuts into planned output levels, so it becomes imperative to try to avoid shutdowns and to quickly resolve problems when they do appear.

Lean systems use a comprehensive approach to quality. Quality is designed into the product and the production process. High quality levels can occur because lean systems produce standardized products that lead to standardized job methods, employ workers who are very familiar with their jobs, and use standardized equipment. Moreover, the cost of product design quality (i.e., building quality in at the *design* stage) can be spread over many units, yielding a low cost per unit. It is also important to choose appropriate quality levels in terms of the final customer and of manufacturing capability. Thus, product design and process design must go hand in hand.

Engineering changes can be very disruptive to smooth operations. Concurrent engineering practices (described in Chapter 4) can substantially reduce these disruptions.

Process Design

Eight aspects of process design are particularly important for lean production systems:

1. Small lot sizes
2. Setup time reduction
3. Manufacturing cells
4. Quality improvement
5. Production flexibility
6. A balanced system
7. Little inventory storage
8. Fail-safe methods

Small Lot Sizes. In the lean philosophy, the ideal lot size is one unit, a quantity that may not always be realistic owing to practical considerations requiring minimum lot sizes (e.g., machines that process multiple items simultaneously, heat-treating equipment that processes multiple items simultaneously, and machines with very long setup times). Nevertheless, the goal is still to reduce the lot size as much as possible. Small lot sizes in both the production process and deliveries from suppliers yield a number of benefits that enable lean systems to operate effectively. First, with small lots moving through the system, in-process inventory is considerably less than it is with large lots. This reduces carrying costs, space requirements, and clutter in the workplace. Second, inspection and rework costs are less when problems with quality occur, because there are fewer items in a lot to inspect and rework.

Small lots also permit greater flexibility in scheduling. Repetitive systems typically produce a small variety of products. In traditional systems, this usually means long production runs of each product, one after the other. Although this spreads the setup cost for a run over many items, it also results in long cycles over the entire range of products. For instance, suppose a firm has three product versions, A, B, and C. In a traditional system, there would be a long run of version A (e.g., covering two or three days or more), then a long run of version B,

FIGURE 14.2

Small versus large-lot run sizes

A = units of product A
 B = units of product B
 C = units of product C



TABLE 14.1

Benefits of small lot sizes

- Reduced inventory, lower carrying costs
- Less space required to store inventory
- Less rework if defects occur
- Less inventory to “work off” before implementing product improvements
- Increased visibility of problems
- Increased production flexibility
- Increased ease of balancing operations

followed by a long run of version C before the sequence would repeat. In contrast, a lean system, using small lots, would frequently shift from producing A to producing B and C. This flexibility enables lean systems to respond more quickly to changing customer demands for output: Lean systems can produce just what is needed, when it is needed. The contrast between small and large lot sizes is illustrated in Figure 14.2. A summary of the benefits of small lot sizes is presented in Table 14.1.

It is important to note that the use of small lot sizes is not in conflict with the economic order quantity (EOQ) approach. Space is at a premium in Japan, making warehousing costs and the cost of space to store extra inventory near manufacturing very high. Also, on-site inventory increases the space between operations, which decreases communications, increases cycle time, and reduces visibility. All of these add to the burden of carrying inventory. So in an EOQ computation, using higher carrying cost, with carrying cost in the denominator, lot sizes naturally end up being smaller, and in some cases, much smaller.

Setup Time Reduction. Small lots and changing product mixes require frequent setups. Unless these are quick and relatively inexpensive, the time and cost to accomplish them can be prohibitive. Moreover, long setup times require holding more inventory than with short setup times. Hence, there is strong emphasis on reducing setup times. In JIT, workers are often trained to do their own setups. Moreover, programs to reduce setup time and cost are used to achieve the desired results; a deliberate effort is required, and workers are usually a valuable part of the process.

Shigeo Shingo made a very significant contribution to lean operation with the development of what is called the **single-minute exchange of die (SMED)** system for reducing changeover time. It involves first categorizing changeover activities as either “internal” or “external” activities. Internal activities are those that can only be done while a machine is stopped (i.e., not running). Hence, they contribute to long changeover times. External activities are those that do not involve stopping the machine; they can be done before or after the changeover.

Hence, they do not affect changeover time. After activities have been categorized, a simple approach to achieving quick changeovers is to convert as many internal activities as possible to external activities and then streamline the remaining internal activities.

The potential benefits that can be achieved using the SMED system were impressively illustrated in 1982 at Toyota, when the changeover time for a machine was reduced from 100 minutes to 3 minutes! The principles of the SMED system can be applied to any changeover operation.

Setup tools and equipment and setup procedures must be simple and standardized. Multi-purpose equipment or attachments can help to reduce setup time. For instance, a machine with

Single-minute exchange of die (SMED) A system for reducing changeover time.



GENERAL MILLS STUDIED NASCAR PIT CREW TO REDUCE CHANGEOVER TIME

When General Mills wanted to reduce the time needed for a process changeover at one of its plants, it turned to NASCAR. The food company sent a team to study how a pit crew was able to fuel up a race car and change its wheels.

After studying the NASCAR crew, General Mills cut to 20 minutes—from as long as 412 minutes—the time it took to switch over a production line from one product to another.

Based on Karen Mills, “General Mills Looks Outside the Box for Innovation.”

multiple spindles that can easily be rotated into place for different job requirements can drastically reduce job changeover time. Moreover, *group technology* (described in Chapter 6) may be used to reduce setup cost and time by capitalizing on similarities in recurring operations. For instance, parts that are similar in shape, materials, and so on, may require very similar setups. Processing them in sequence on the same equipment can reduce the need to completely change a setup; only minor adjustments may be necessary.

Manufacturing Cells. One characteristic of lean production systems is multiple *manufacturing cells*. The cells contain the machines and tools needed to process families of parts having similar processing requirements. In essence, the cells are highly specialized and efficient production centers. Among the important benefits of manufacturing cells are reduced changeover times, high utilization of equipment, and ease of cross-training operators.

Quality Improvement. The occurrence of quality defects during the process can disrupt the orderly flow of work. Consequently, problem solving is important when defects occur. Moreover, there is a never-ending quest for *quality improvement*, which often focuses on finding and eliminating the causes of problems so they do not continually crop up.

Lean production systems sometimes minimize defects through the use of **autonomation** (note the extra syllable *on* in the middle of the word). Also referred to as *jidoka*, it involves the automatic detection of defects during production. It can be used with machines or manual operations. It consists of two mechanisms: one for detecting defects when they occur, and another for a human stopping production to correct the cause of the defects. Thus, the halting of production forces immediate attention to the problem, after which an investigation of the problem is conducted, and corrective action is taken to resolve the problem.

Autonomation Automatic detection of defects during production.



Miguel Medina/AFP/Getty Images

A worker is assembling a Louis Vuitton handbag at the company's fine leather goods factory in the Normandy town of Ducey in France. To keep its brand exclusive and contain costs, the company monitors growth and incorporates lean production processes.

TABLE 14.2

Guidelines for increasing production flexibility

1. Reduce downtime due to changeovers by reducing changeover time.
2. Use preventive maintenance on key equipment to reduce breakdowns and downtime.
3. Cross-train workers so they can help when bottlenecks occur or other workers are absent. Train workers to handle equipment adjustments and minor repairs.
4. Use many small units of capacity; many small cells make it easier to shift capacity temporarily and to add or subtract capacity than a few units of large capacity.
5. Use offline buffers. Store infrequently used safety stock away from the production area to decrease congestion and to avoid continually turning it over.
6. Reserve capacity for important customers.

Source: Adapted from Edward M. Knod, jr. and Richard J. Schonberger, *Operations Management: Meeting Customers' Demands*, 7th ed. New York: McGraw-Hill, 2001.

Production Flexibility. Overall goal of a lean system is to achieve the ability to process a mix of products or services in a smooth flow. One potential obstacle to this goal is bottlenecks that occur when portions of the system become overloaded. The existence of bottlenecks reflects inflexibilities in a system. Process design can increase *production flexibility* and reduce bottlenecks in a variety of ways. Table 14.2 lists some of the techniques used for this purpose.

A Balanced System. Line balancing of production lines (i.e., distributing the workload evenly among workstations) helps to achieve a rapid flow of work through the system. Time needed for work assigned to each workstation must be less than or equal to the cycle time. The cycle time is set equal to what is referred to as the *takt time*. (*Takt* is the German word for musical meter.) **Takt time** is the cycle time needed in a production system to match the pace of production to the demand rate. It is sometimes said to be the heartbeat of a lean production system.

Takt time is often set for a work shift. The procedure for obtaining the *takt* time is:

1. Determine the net time available per shift by subtracting any nonproductive time from total shift time.
2. If there is more than one shift per day, multiply the net time per shift by the number of shifts to obtain the net available time per day.
3. Compute *takt* time by dividing the net available time by demand.

Takt time The cycle time needed to match customer demand to the final product.

EXAMPLE 1

excel

mhhe.com/stevenson14e

Computing Takt Time

Given the following information, compute the *takt* time: Total time per shift is 480 minutes per day, and there are two shifts per day. There are two 20-minute rest breaks and a 30-minute lunch break per shift. Daily demand is 80 units.

SOLUTION

1. Compute net time available per shift:

Total time	480 minutes
Rest breaks	−40 minutes
Lunch	−30 minutes
	410 minutes per shift

2. Compute the net time available per day:

410 minutes per shift
× 2 shifts/day
820 minutes per day

3. Compute the *takt* time:

$$\begin{aligned}
 \text{Takt time} &= \frac{\text{Net time available per day}}{\text{Daily demand}} = \frac{820 \text{ minutes per day}}{80 \text{ units per day}} \\
 &= 10.25 \text{ minutes per cycle}
 \end{aligned}
 \tag{14-1}$$

FIGURE 14.3 Large rocks (problems) are hidden by a high water level (inventory) in (A). Lower water level (B) reveals rocks (problems such as bottlenecks, waste, poor timing). Once the large rocks are removed, the water level (inventory) can be lowered (C). This process would be done repeatedly in the spirit of continuous improvement, achieving additional improvements with each iteration.

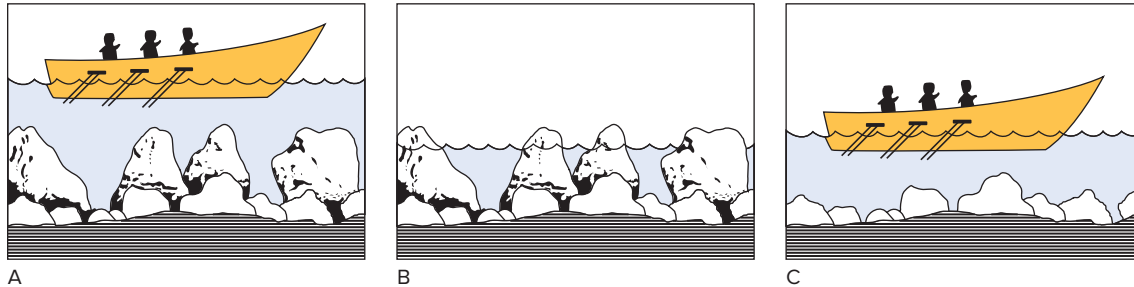

Once the *takt* time for the system has been determined, it can be used to determine the time that should be allotted to each workstation in the production process. Using the *takt* time results in minimizing work-in-process (WIP) inventory in instances where demand is stable and the system capacity matches demand. For unstable demand, additional inventory is needed to offset demand variability.

Little Inventory Storage. Lean systems are designed to *minimize* inventory storage. Recall that in the lean philosophy, inventory storage is a waste. Inventories are buffers that tend to cover up recurring problems that are never resolved, partly because they aren't obvious and partly because the presence of inventory makes them seem less serious. When a machine breaks down, it won't disrupt the system if there is a sufficient inventory of the machine's output to feed into the next workstation. The use of inventory as the "solution" can lead to increasing amounts of inventory if breakdowns increase. A better solution is to investigate the *causes* of machine breakdowns and focus on eliminating them. Similar problems with quality, unreliable vendors, and scheduling also can be solved by having ample inventories to fall back on. However, carrying all that extra inventory creates a tremendous burden in cost and space and allows problems to go unresolved.



A lean automobile assembly line.

The lean approach is to pare down inventories gradually in order to uncover the problems. Once they are uncovered and solved, the system removes more inventory, finds and solves additional problems, and so on. A useful analogy is a boat on a pond that has large, hidden rocks. (See Figure 14.3.) The rocks represent problems that can hinder production (the boat). The water in the pond that covers the rocks is the inventory in the system. As the water level is slowly lowered, the largest rocks are the first to appear (those problems are the first to be identified). At that point, efforts are undertaken to remove these rocks from the water (resolve these problems). Once that has been accomplished, additional water is removed from the pond, revealing the next layer of rocks, which are then worked on. As more rocks are removed, the need for water to cover them diminishes. Likewise, as more of the major production problems are solved, there is less need to rely on inventory or other buffers.

For instance: Carrying extra raw materials allows operation even though vendor deliveries are late or some quality is substandard; carrying extra work-in-process (WIP) can hide problems during production and late deliveries of parts from suppliers; and carrying extra finished goods can make up for poor forecasts.

Low inventories are the result of a *process* of successful problem solving, one that has occurred over time. Furthermore, because it is unlikely that all problems will be found and resolved, it is necessary to be able to deal quickly with problems when they do occur. Hence, there is a continuing need to identify and solve problems within a short time span to prevent new problems from disrupting the smooth flow of work through the system.

One way to minimize inventory storage in a lean system is to have deliveries from suppliers go directly to the production floor, which completely eliminates the need to store incoming parts and materials. At the other end of the process, completed units are shipped out as soon as they are ready, which minimizes storage of finished goods. Coupled with low work-in-process inventory, these features result in systems that operate with very little inventory.

Among the advantages of lower inventory are less carrying cost, less space needed, less tendency to rely on buffers, less rework if defects occur, and less need to “work off” current inventory before implementing design improvements. But carrying less inventory also has some risks: The primary one is that if problems arise, there is no safety net. Another is missed opportunities if the system is unable to respond quickly to them.

Fail-Safe Methods. Failsafing refers to building safeguards into a process to reduce or eliminate the potential for errors during a process. The term that was used initially was *baka-yoke*, which meant “foolproofing.” However, due to its offensive connotations, the term was changed to *poka-yoke*, which means “mistake proofing.” Some examples of failsafing include an alarm that sounds if the weight of a packaged item is too low, indicating missing components; putting assembly components in “egg cartons” to ensure that no parts are left out; and designing parts that can only be attached in the correct position. There are several everyday examples in vehicles, including signals that warn that the key is still in the ignition if the car door is opened, warn if a door is ajar, warn if seatbelts are not fastened, or warn if the fuel level is low. Other examples include an ATM signal if a card is left in a machine, detectors at department stores that signal if a monitoring tag hasn’t been removed from an item, electrical fuses and circuit breakers that interrupt electrical supply if a circuit is overloaded, computers and other devices that won’t operate if an incorrect password is used, and so on. Much of the credit for *poka-yoke* thinking is attributed to the work of Shigeo Shingo, who extensively promoted the use of failsafing in operations.

Poka-yoke Safeguards built into a process to reduce the possibility of errors.

Personnel/Organizational Elements

Five elements of personnel and organization are particularly important for lean systems:

1. Workers as assets
2. Cross-trained workers
3. Continuous improvement
4. Cost accounting
5. Leadership/project management

Workers as Assets. A fundamental tenet of the lean philosophy is that *workers are assets*. Well-trained and motivated workers are the heart of a lean system. They are given more authority to make decisions than their counterparts in more traditional systems, but they are also expected to do more.

Cross-Trained Workers. Workers are *cross-trained* to perform several parts of a process and operate a variety of machines. This adds to system flexibility because workers are able to help one another when bottlenecks occur or when a coworker is absent. It also helps line balancing.

Continuous Improvement. Workers in a lean system have greater responsibility for quality than workers in traditional systems, and they are expected to be involved in problem solving and *continuous improvement*. Lean system workers receive extensive training in statistical process control, quality improvement, and problem solving.

Problem solving is a cornerstone of any lean system. Of interest are problems that interrupt, or have the potential to interrupt, the smooth flow of work through the system. When such problems surface, it becomes important to resolve them quickly. This may entail increasing inventory levels *temporarily* while the problem is investigated, but the intent of problem solving is to eliminate the problem, or at least greatly reduce the chances of it recurring.

Problems that occur during production must be dealt with quickly. Some companies use a light system to signal problems; in Japan, such a system is called **andon**. Each workstation is equipped with a set of three lights. A green light means no problems, an amber light means a worker is falling a little bit behind, and a red light indicates a serious problem. The purpose of the light system is to keep others in the system informed and to enable workers and supervisors to immediately see when and where problems are occurring.

Japanese companies have been very successful in forming teams composed of workers and managers who routinely work on problems. Moreover, workers are encouraged to report problems and potential problems to the teams.

It is important that all levels of management actively support and become involved in problem solving. This includes a willingness to provide financial support and to recognize achievements. It is desirable to formulate goals with the help of workers, publicize the goals, and carefully document accomplishments. Goals give workers something tangible to strive for, and recognition can help maintain worker interest and morale.

Andon System of lights used at each workstation to signal problems or slowdowns.



The Andon board advises employees of the real-time status of each car within the line, enabling the production system to be run more effectively.

A central theme of a true lean approach is to work toward continual improvement of the system—reducing inventories, reducing setup cost and time, improving quality, increasing the output rate, and generally cutting waste and inefficiency. Toward that end, problem solving becomes a way of life—a “culture” that must be assimilated into the thinking of management and workers alike. It becomes a never-ending quest for improving operations as all members of the organization strive to improve the system.

One challenge to continuous improvement is that once the “easy” improvements have been made, it becomes more difficult to keep workers motivated to continue to look for further improvements.

Workers in lean systems have more stress than their counterparts in more traditional systems. Stress comes not only from their added authority and responsibility but also from the high-paced system they work in, where there is little slack and a continual push to improve.

Cost Accounting. Another feature of some lean systems is the method of allocating overhead. Traditional accounting methods sometimes distort overhead allocation because they allocate it on the basis of direct labor hours. However, that approach does not always accurately reflect the consumption of overhead by different jobs. In addition, the number of direct labor hours in some industries has declined significantly over the years and now frequently accounts for a relatively small portion of the total cost. Conversely, other costs now represent a major portion of the total cost. Therefore, labor-intensive jobs (i.e., those that use relatively large proportions of direct labor) may be assigned a disproportionate share of overhead, one that does not truly reflect actual costs. That, in turn, can cause managers to make poor decisions. Furthermore, the need to track direct labor hours can itself involve considerable effort. One alternative method of allocating overhead is **activity-based costing**. This method is designed to more closely reflect the actual amount of overhead consumed by a particular job or activity. Activity-based costing first identifies traceable costs and then assigns those costs to various types of activities such as machine setups, inspection, machine hours, direct labor hours, and movement of materials. Specific jobs are then assigned overhead based on the percentage of activities they consume.

Activity-based costing

Allocation of overhead to specific jobs based on their percentage of activities.

Leadership/Project Management. Another feature of lean systems relates to *leadership*. Managers are expected to be leaders and facilitators, not order givers. Lean encourages two-way communication between workers and managers.

Manufacturing Planning and Control

Seven elements of manufacturing planning and control are particularly important for lean systems:

1. Level loading
2. Pull systems
3. Visual systems
4. Limited work-in-process (WIP)
5. Close vendor relationships
6. Reduced transaction processing
7. Preventive maintenance and housekeeping

Level Loading. Lean systems place a strong emphasis on achieving stable, level daily mix schedules. Toward that end, the master production schedule is developed to provide *level capacity loading*. That may entail a rate-based production schedule instead of the more familiar quantity-based schedule. Moreover, once established, production schedules are relatively fixed over a short time horizon, and this provides certainty to the system. Even so, some adjustments may be needed in day-to-day schedules to achieve level capacity requirements. Suppliers like level loading because it means smooth demand for them.

A level production schedule requires smooth production. When a company produces different products or product models, it is desirable to produce in small lots (to minimize work-in-process inventory and to maintain flexibility) and to spread the production of the different products throughout the day to achieve smooth production. The extreme case would be to produce one unit of one product, then one of another, then one of another, and so on. While this approach would allow for maximum smoothness, it would generally not be practical because it would generate excessive setup costs.

Mixed-model sequencing begins with daily production requirements of each product or model. For instance, suppose a department produces three models, A, B, and C, with these daily requirements.

Three issues then need to be resolved. One is which sequence to use (C-B-A, A-C-B, etc.), another is how many times (i.e., cycles) the sequence should be repeated daily, and the third is how many units of each model to produce in each cycle.

Model	Daily Quantity
A	10
B	15
C	5

The choice of sequence can depend on several factors, but the key one is usually the setup time or cost, which may vary depending on the sequence used. For instance, if two of the models, say A and C, are quite similar, the sequences A-C and C-A may involve only minimal setup changes, whereas the setup for model B may be more extensive. Choosing a sequence that has A-C or C-A will result in about 20 percent fewer setups over time than having B produced between A and C on every cycle.

The number of cycles per day depends on the daily production quantities. If every model is to be produced in every cycle, which is often the goal, determining the smallest integer that can be evenly divided into each model's daily quantity will indicate the number of cycles. This will be the fewest number of cycles that will contain one unit of the model with the lowest quantity requirements. For models A, B, and C shown in the preceding table, there should be five cycles (five can be evenly divided into each quantity). High setup costs may cause a manager to use fewer cycles, trading off savings in setup costs and level production. If dividing by the smallest daily quantity does not yield an integer value for each model, a manager may opt for using the smallest production quantity to select a number of cycles, but then produce more of some items in some cycles to make up the difference.

Sometimes a manager determines the number of units of each model in each cycle by dividing each model's daily production quantity by the number of cycles. Using five cycles per day would yield the following:

Model	Daily Quantity	Units per Cycle
A	10	$10/5 = 2$
B	15	$15/5 = 3$
C	5	$5/5 = 1$

These quantities may be unworkable due to restrictions on lot sizes. For example, model B may be packed four to a carton, so producing three units per cycle would mean that, at times, finished units (inventory) would have to wait until sufficient quantities were available to fill a crate. Similarly, there may be standard production lot sizes for some operations. A heat-treating process might involve a furnace that can handle six units at a time. If the different models require different furnace temperatures, they could not be grouped. What would be necessary here is an analysis of the trade-off between furnace lot size and the advantages of level production.

EXAMPLE 2

Developing a Production Plan

Determine a production plan for these three models using the sequence A-B-C.

Model	Daily Quantity
A	7
B	16
C	5

SOLUTION

The smallest daily quantity is five, but dividing the other two quantities by five does not yield integers. The manager might still decide to use five cycles. Producing one unit of models A and C and three units of model B in each of the five cycles would leave the manager short two units of model A and one unit of model B. The manager might decide to intersperse those units, as in the following, to achieve nearly level production:

Cycle	1	2	3	4	5
Pattern	A B(3) C	A(2) B(3) C	A B(4) C	A(2) B(3) C	A B(3) C
Extra unit(s)		A	B	A	

If the requirement for model A had been eight units a day instead of seven, the manager might decide to use the following pattern:

Cycle	1	2	3	4	5
Pattern	A(2) B(3) C	A B(3) C	A(2) B(4) C	A B(3) C	A(2) B(3) C
Extra unit(s)	A		AB		A

Push system Work is pushed to the next station as it is completed.

Pull system A workstation pulls output from the preceding station as it is needed.

Pull Systems. The terms *push* and *pull* are used to describe two different systems for moving work through a production process. In traditional production environments, a **push system** is used: When work is finished at a workstation, the output is *pushed* to the next station; or, in the case of the final operation, it is pushed on to final inventory. Conversely, in a **pull system**, control of moving the work rests with the following operation; each workstation *pulls* the output from the preceding station as it is needed; output of the final operation is pulled by customer demand or the master schedule. Thus, in a pull system, work moves on in response to demand from the next stage in the process, whereas in a push system, work moves on as it is completed, without regard to the next station's readiness for the work. Consequently, work may pile up at workstations that fall behind schedule because of equipment failure or the detection of a problem with quality.

Communication moves backward through the system from station to station. Each workstation (i.e., customer) communicates its need for more work to the preceding workstation (i.e., supplier), thereby assuring that supply equals demand. Work moves "just in time" for the next operation; the flow of work is thereby coordinated, and the accumulation of excessive inventories between operations is avoided. Of course, some inventory is usually present because operations are not instantaneous. If a workstation waited until it received a request from the next workstation before starting its work, the next station would have to wait for the preceding station to perform its work. Therefore, by design, each workstation produces just enough output to meet the (anticipated) demand of the next station. This can be accomplished by having the succeeding workstation communicate its need for input sufficiently ahead of time to allow the preceding station to do the work. Or there can be a small buffer of stock between stations; when the buffer decreases to a certain level, this signals the preceding station to produce enough output to replenish the buffer supply. The size of the buffer supply

depends on the cycle time at the preceding workstation. If the cycle time is short, the station will need little or no buffer; if the cycle time is long, it will need a considerable amount of buffer. However, production occurs only in response to *usage* of the succeeding station; work is still pulled by the demand generated by the next operation.

Pull systems aren't necessarily appropriate for all manufacturing operations because they require a fairly steady flow of repetitive work. Large variations in volume, product mix, or product design will undermine the system.

Visual Systems. In a pull system, work flow is dictated by “next-step demand.” A system can communicate such demand in a variety of ways, including a shout or a wave, but by far the most commonly used device is the **kanban** card. *Kanban* is a Japanese word meaning “signal” or “visible record.” When a worker needs materials or work from the preceding station, he or she uses a kanban card. In effect, the kanban card is the *authorization* to move or work on parts. In kanban systems, no part or lot can be moved or worked on without one of these cards.

There are two main types of kanbans:

- **Production kanban (p-kanban):** signals the need to produce parts
- **Conveyance kanban (c-kanban):** signals the need to deliver parts to the next work center

The system works this way: A kanban card is affixed to each container. When a workstation needs to replenish its supply of parts, a worker goes to the area where these parts are stored and withdraws one container of parts. Each container holds a predetermined quantity. The worker removes the kanban card from the container and posts it in a designated spot where it will be clearly visible, and the worker moves the container to the workstation. The posted kanban is then picked up by a stock person who replenishes the stock with another container, and so on down the line. Demand for parts triggers a replenishment, and parts are supplied as usage dictates. Similar withdrawals and replenishments—all controlled by kanbans—occur all the way up and down the line from vendors to finished-goods inventories. If supervisors decide the system is too loose because inventories are building up, they may decide to tighten the system and withdraw some kanbans. Conversely, if the system seems too tight, they may introduce additional kanbans to bring the system into balance. Vendors also can influence the number of containers. Moreover, trip times can affect the number: Longer trip times may lead to fewer but larger containers, while shorter trip times may involve a greater number of small containers.

Kanban Card or other device that communicates demand for work or materials from the preceding station.



Daniel Ingold/Getty Images

At Tri-State Industries, a kanban system is in effect to move work through the production system. Shown here, a kanban card provides the authorization to move or work on parts.



The Asahi Shimbun/Getty Images

Special carts were designed that, when filled, act as a visual signal that they are ready to be moved to the next work cell. An empty cart indicates it is time to produce, in order to refill the cart.

It is apparent that the number of kanban cards in use is an important variable. One can compute the ideal number of kanban cards using this formula:

$$N = \frac{D(T)(1 + X)}{C} \quad (14-2)$$

where

N = Total number of containers (1 card per container)

D = Planned usage rate of using work center

T = Average waiting time for replenishment of parts plus average production time for a container of parts

X = Policy variable set by management that reflects possible inefficiency in the system (the closer to 0, the more efficient the system)

C = Capacity of a standard container (should be no more than 10 percent of daily usage of the part)

Note that D and T must use the same units (e.g., minutes, days).

EXAMPLE 3

Determining the Number of Kanban Cards Needed

Usage at a work center is 300 parts per day, and a standard container holds 25 parts. It takes an average of .12 day for a container to complete a circuit from the time a kanban card is received until the container is returned empty. Compute the number of kanban cards (containers) needed if $X = .20$.

SOLUTION

$N = ?$

$D = 300$ parts per day

$T = .12$ day

$C = 25$ parts per container

$X = .20$

$$N = \frac{300(.12)(1 + .20)}{25} = 1.728; \text{ round to 2 containers}$$

Note: Rounding up will cause the system to be looser, and rounding down will cause it to be tighter. Usually, rounding up is used.

Although the goals of MRP and kanban are essentially the same (i.e., to improve customer service, reduce inventories, and increase productivity), their approaches are different. Neither MRP nor kanban is a stand-alone system—each exists within a larger framework. MRP is a computerized system, whereas kanban is a manual system that may be part of a lean system, although lean can exist without kanban.

Kanban is essentially a two-bin type of inventory: Supplies are replenished semiautomatically when they reach a predetermined level. MRP is more concerned with projecting requirements and with planning and scheduling operations.

A major benefit of the kanban system is its simplicity, whereas a major benefit of MRP is its ability to handle complex planning and scheduling. In addition, MRP II enables management to answer what-if questions for capacity planning.

The philosophies that underlie kanban systems are quite different from those traditionally held by manufacturers. Nonetheless, both approaches have their merits, so it probably would not make sense in most instances to switch from one method of operation to the other. Moreover, to do so would require a tremendous effort. It is noteworthy that at the same time that Western manufacturers are studying kanban systems, some Japanese manufacturers are studying MRP systems. This suggests the possibility that either system could be improved by

incorporating selected elements of the other. That would take careful analysis to determine which elements to incorporate, as well as careful implementation of selected elements, and close monitoring to assure that intended results were achieved.

Whether manufacturers should adopt the kanban method is debatable. Some form of it may be useful, but kanban is merely an information system; by itself it offers little in terms of helping manufacturers become more competitive or productive. By the same token, MRP alone will not achieve those results either. Instead, it is the overall approach to manufacturing that is crucial; it is the commitment and support of top management and the continuing efforts of all levels of management to find new ways to improve their manufacturing planning and control techniques, and to adapt those techniques to fit their particular circumstances, that will determine the degree of success.

Comment The use of either kanban or MRP does not preclude use of the other. In fact, it is not unusual to find the two systems used in the same production facility. Some Japanese manufacturers, for example, are turning to MRP systems to help them plan production. Both approaches have their advantages and limitations. MRP systems provide the capability to explode the bill of materials to project timing and material requirements that can then be used to plan production. But the MRP assumption of fixed lead times and infinite capacity can often result in significant problems. At the shop floor level, the discipline of a kanban system, with materials pull, can be very effective. But kanban works best when there is a uniform flow through the shop; a variable flow requires buffers, and this reduces the advantage of a pull system.

In effect, some situations are more conducive to a visual approach, others to an MRP approach. Still others can benefit from a hybrid of the two. Hybrid systems like kanban/MRP can be successful if MRP is used for planning and kanban is used as the execution system.

Limited Work-in-Process (WIP). Movement of materials and WIP in a lean system is carefully coordinated, so that they arrive at each step in a process just as they are needed. Controlling the amount of WIP in a production system can yield substantial benefits. One is lower carrying costs due to lower WIP inventory. Another is the increased flexibility that would be lost if there were large amounts of WIP in the system. In addition, low WIP aids scheduling and saves costs of rework and scrapping if there are design changes.

Controlling WIP also results in low cycle-time variability. WIP is determined by cycle time and the arrival rate of jobs. According to Little's law, $WIP = \text{Cycle time} \times \text{Arrival rate}$. If both WIP and the arrival rate of jobs are held constant, the cycle time will also be constant. In a push system, the arrival rate of jobs is not held constant, so there is the possibility of large WIP buildups, which results in high variability in cycle times. This forces companies to quote longer lead times to customers to allow for variable cycle times.

There are two general approaches to controlling WIP: One is kanban and the other is constant work-in-process (CONWIP). Kanban's control of WIP focuses on individual workstations, while CONWIP's focus is on the system as a whole. With CONWIP, when a job exits the system, a new job is allowed to enter. This results in a constant level of work-in-process.

Kanban works best in an environment that is stable and predictable. CONWIP offers an advantage if there is variability in a line, perhaps due to a breakdown in an operation or a quality problem. With kanban, upstream work is blocked and processing will stop fairly quickly, while with CONWIP upstream stations can continue to operate for a somewhat longer time. Then, after the reason for stoppage has been corrected, there will be less need to make up lost production than if the entire line had been shut down, as it would be under kanban. Also, in a mixed product environment, CONWIP can be easier than kanban because kanban focuses on specific part numbers whereas CONWIP does not.

Close Vendor Relationships. Lean systems typically have *close relationships with vendors*, who are expected to provide frequent small deliveries of high-quality goods. Traditionally, buyers have assumed the role of monitoring the quality of purchased goods, inspecting shipments for quality and quantity, and returning poor-quality goods to the vendor for rework. JIT

systems have little slack, so poor-quality goods cause a disruption in the smooth flow of work. Moreover, the inspection of incoming goods is viewed as inefficient because it does not add value to the product. For these reasons, the burden of ensuring quality shifts to the vendor. Buyers work with vendors to help them achieve the desired quality levels and to impress upon them the importance of consistent, high-quality goods. The ultimate goal of the buyer is to be able to *certify* a vendor as a producer of high-quality goods. The implication of certification is that a vendor can be relied on to deliver high-quality goods without the need for buyer inspection.

Suppliers also must be willing and able to ship in small lots on a regular basis. Ideally, suppliers themselves will be operating under JIT systems. Buyers can often help suppliers convert to JIT production based on their own experiences. In effect, the supplier becomes part of an extended JIT system that integrates the facilities of buyer and supplier. Integration is easier when a supplier is dedicated to only one or a few buyers. In practice, a supplier is likely to have many different buyers, some using traditional systems and others using JIT. Consequently, compromises may have to be made by both buyers and suppliers.

Traditionally, a spirit of cooperation between buyer and seller has not been present; buyers and vendors have had a somewhat adversarial relationship. Buyers have generally regarded price as a major determinant in sourcing, and they have typically used *multiple-source* purchasing, which means having a list of potential vendors and buying from several to avoid getting locked into a sole source. In this way, buyers play vendors off against each other to get better pricing arrangements or other concessions. The downside is that vendors cannot rely on a long-term relationship with a buyer, and they feel no loyalty to a particular buyer. Furthermore, vendors have often sought to protect themselves from losing a buyer by increasing the number of buyers they supply.

Under JIT purchasing, good vendor relationships are very important. Buyers take measures to reduce their lists of suppliers, concentrating on maintaining close working relationships with a few good ones. Because of the need for frequent, small deliveries, many buyers attempt to find local vendors to shorten the lead time for deliveries and to reduce lead time variability. An added advantage of having vendors nearby is quick response when problems arise.

JIT purchasing is enhanced by long-term relationships between buyers and vendors. Vendors are more willing to commit resources to the job of shipping according to a buyer's JIT system given a long-term relationship. Moreover, price often becomes secondary to other aspects of the relationship (e.g., consistent high quality, flexibility, frequent small deliveries, and quick response to problems).

Supplier Tiers A key feature of many lean production systems is the relatively small number of suppliers used. In traditional production, companies often deal with hundreds or even thousands of suppliers in a highly centralized arrangement, not unlike a giant wheel with many spokes. The company is at the hub of the wheel, and the spokes radiate out to suppliers, each of whom must deal directly with the company. In traditional systems, a supplier does not know the other suppliers or what they are doing. Each supplier works to specifications provided by the buyer. Suppliers have very little basis (or motivation) for suggesting improvements. Moreover, as companies play one supplier off against others, the sharing of information is more risky than rewarding. In contrast, lean production companies may employ a tiered approach for suppliers: They use relatively few first-tier suppliers who work directly with the company or who supply major subassemblies. The first-tier suppliers are responsible for dealing with second-tier suppliers who provide components for the subassemblies, thereby relieving the final buyer from dealing with large numbers of suppliers.

The automotive industry provides a good example of this situation. Suppose a certain car model has an electric seat. The seat and motor together might entail 250 separate parts. A traditional producer might use more than 30 suppliers for the electric seat, but a lean producer might use a single (first-tier) supplier who has the responsibility for the entire seat unit. The company would provide specifications for the overall unit, but leave to the supplier the details of the motor, springs, and so on. The first-tier supplier, in turn, might subcontract the motor to a second-tier supplier, the track to another second-tier supplier, and the cushions and fabric to still another. The second-tier suppliers might subcontract some of their work to third-tier

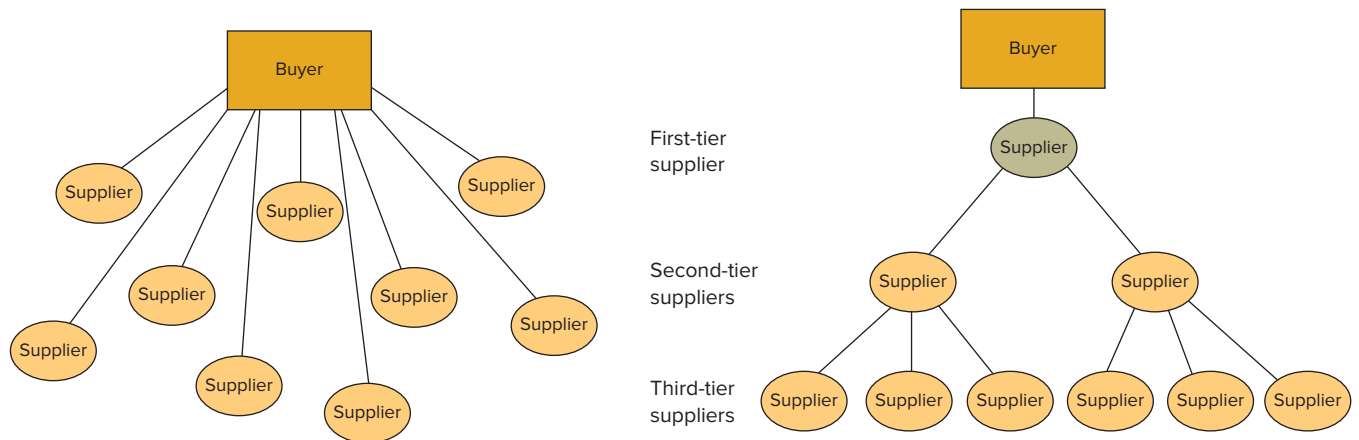
FIGURE 14.4 Traditional supplier network compared to supplier tiers

suppliers, and so on. Each tier has only to deal with those just above it or just below it. Suppliers on each level are encouraged to work with each other, and they are motivated to do so because that increases the probability that the resulting item (the seat) will meet or exceed the final buyer's expectations. In this "team of suppliers" approach, all suppliers benefit from a successful product, and each supplier bears full responsibility for the quality of its portion of the product. Figure 14.4 illustrates the difference between the traditional approach and the tiered approach.

Reduced Transaction Processing. Traditional manufacturing systems often have many built-in transactions that do not add value. In their classic article, "The Hidden Factory,"² Jeffrey G. Miller and Thomas Vollmann identify a laundry list of transaction processing that comprises a "hidden factory" in traditional manufacturing planning and control systems, and point out the tremendous cost burden that results. The transactions can be classified as logistical, balancing, quality, or change transactions.

Logistical transactions include ordering, execution, and confirmation of materials transported from one location to another. Related costs cover shipping and receiving personnel, expediting orders, data entry, and data processing.

Balancing transactions include forecasting, production planning, production control, procurement, scheduling, and order processing. Associated costs relate to the personnel involved in these and supporting activities.

Quality transactions include determining and communicating specifications, monitoring, recording, and follow-up activities. Costs relate to appraisal, prevention, internal failures (e.g., scrap, rework, retesting, delays, administration activities) and external failures (e.g., warranty costs, product liability, returns, potential loss of future business).

Change transactions primarily involve engineering changes and the ensuing changes generated in specifications, bills of material, scheduling, processing instructions, and so on. Engineering changes are among the most costly of all transactions.

Lean systems cut transaction costs by reducing the number and frequency of transactions. For example, suppliers deliver goods directly to the production floor, bypassing the storeroom entirely, thereby avoiding the transactions related to receiving the shipment into inventory storage and later moving the materials to the production floor. In addition, vendors are certified for quality, eliminating the need to inspect incoming shipments for quality. The unending quest for quality improvement that pervades lean systems eliminates many of the previously mentioned quality transactions and their related costs. The use of bar coding (not exclusive to lean systems) can reduce data entry transactions and increase data accuracy.

²Excerpted from Jeffrey Miller and Thomas Vollmann, "The Hidden Factory," *Harvard Business Review*, September/October 1985, pp. 141–50. Copyright © 1985 by the Harvard Business School Publishing Corporation. All rights reserved.

TABLE 14.3

Comparison of lean and traditional production philosophies

Factor	Traditional	Lean
Inventory	Much, to offset forecast errors, late deliveries	Minimal necessary to operate
Deliveries	Few, large	Many, small
Lot sizes	Large	Small
Setups, runs	Few, long runs	Many, short runs
Vendors	Long-term relationships are unusual	Partners
Workers	Necessary to do the work	Assets

Preventive maintenance

Proactive approach; reducing breakdowns through a program of lubrication, adjustment, cleaning, inspection, and replacement of worn parts.

Housekeeping Maintaining a workplace that is clean and free of unnecessary materials.

Preventive Maintenance and Housekeeping. Because lean systems have very little in-process inventory, equipment breakdowns can be extremely disruptive. To minimize breakdowns, companies use **preventive maintenance** programs, which emphasize maintaining equipment in good operating condition and replacing parts that have a tendency to fail before they fail. Workers are often responsible for maintaining their own equipment.

Even with preventive maintenance, occasional equipment failures will occur. Companies must be prepared for this, so they can quickly return equipment to working order. This may mean maintaining supplies of critical spare parts and making other provisions for emergency situations, perhaps maintaining a small force of repair people or training workers to do certain repairs themselves. Note that when breakdowns do occur, they indicate potential opportunities to be exploited in a lean environment.

Housekeeping involves keeping the workplace clean, as well as keeping it free of any materials that are not needed for production, because those materials take up space and may cause disruptions to the work flow.

Housekeeping is part of what is often referred to as the five S's, which are five behaviors intended to make the workplace effective:

1. **Sort.** Decide which items are needed to accomplish the work, and keep only those items.
2. **Straighten.** Organize the workplace so that the needed items can be accessed quickly and easily.
3. **Sweep.** Keep the workplace clean and ready for work. Perform equipment maintenance regularly.
4. **Standardize.** Use standard instructions and procedures for all work.
5. **Self-discipline.** Make sure employees understand the need for an uncluttered workplace.

The five S's are gaining increasing recognition as an important component of successful lean operations. Among the benefits of the five S's are increased productivity, improved employee morale, decreased risk of accidents, and improved appearance for visitors. However, unless workers and managers appreciate the rationale for the five S's, they may view them as unnecessary and a waste of time and effort.

Lean systems have been described and compared with traditional manufacturing systems in the preceding pages. Table 14.3 provides a brief overview of those comparisons.

LO14.9 Describe key lean improvement tools.

Value stream mapping

A visual tool to systematically examine the flow of materials and information.

14.4 LEAN TOOLS

This section describes several tools used for process improvement in lean systems.

Value Stream Mapping

Value stream mapping is a visual tool to systematically examine the flow of materials and information involved in bringing a product or service to a consumer. The technique originated at Toyota, where it is referred to as “Material and Information Flow Mapping.”

The map is a sketch of an entire process that typically ranges from incoming goods from suppliers to shipment of a product or delivery of a service to the customer. The map shows all processes in the value stream, from arrivals of supplies to the shipping of the product. The objective is to increase value to the customer, where value is typically defined in terms of quality, time, cost, or flexibility (e.g., rapid response or agility). Data collected during the mapping process might include times (e.g., cycle time, setup time, changeover time, touch time, lead time), distances traveled (e.g., by parts, workers, paperwork), mistakes (e.g., product defects, data entry errors), inefficient work methods (e.g., extra motions, excessive lifting or moving, repositioning), and waiting lines (e.g., workers waiting for parts or equipment repairs, orders waiting to be processed). Information flows are also included in the mapping process.

You can get a sense of value stream mapping from the following tips for developing an effective mapping of a value stream:³

1. Map the value stream in person.
2. Begin with a quick walkthrough of the system from beginning to end to get a sense of the system.
3. Then do a more thorough walkthrough following the actual pathway to collect current information on material or information flow.
4. Record elements of the system such as cycle times, scrap rates, amounts of inventory, downtimes, number of operators, distances between processes, and transfer times.

Value improvement for a product or a service embodies the five lean principles described earlier and repeated here. It begins by specifying value from the customer's standpoint. You can see where value stream mapping can help process improvement:

1. Specify value from the standpoint of the end customer.
2. Identify all the steps in the value stream and create a visual (map) of the value stream.
3. Eliminate steps that do not create value or improve flow.
4. Use next-customer-in-the-process demand to pull from each preceding process as needed to control the flow.
5. Repeat this process as long as waste exists in the system.

Once a value stream map is completed, data analysis can uncover improvement opportunities by asking key questions, such as:

- Where are the process bottlenecks?
- Where do errors occur?
- Which processes have to deal with the most variation?
- Where does waste occur?

All business organizations, whether they are primarily engaged in service or manufacturing, can benefit by applying lean principles to their office operations. This includes purchasing, accounting, order entry, and other office functions. Office wastes might include:

- **Excess inventory**—excess supplies and equipment
- **Overprocessing**—excess paperwork and redundant approvals
- **Waiting times**—orders waiting to be processed, requests for information awaiting answers
- **Unnecessary transportation**—inefficient routing
- **Processing waste**—using more resources than necessary to accomplish a task
- **Inefficient work methods**—poor layout design, unnecessary steps, inadequate training
- **Mistakes**—order entry errors, lost files, miscommunications
- **Underused people**—not tapping all of the mental and creative capabilities of workers

³Adapted from Rother, Mike, and John Shook. *Learning to See*. Cambridge, MA: Lean Enterprise Institute, 2009.

TABLE 14.4
The 5W2H approach

Category	5W2H	Typical Questions	Goal
Subject	What?	What is being done?	Identify the focus of analysis.
Purpose	Why?	Why is this necessary?	Eliminate unnecessary tasks.
Location	Where?	Where is it being done? Why is it done there? Would it be better to do it someplace else?	Improve the location.
Sequence	When?	When is it done? Would it be better to do it at another time?	Improve the sequence.
People	Who?	Who is doing it? Could someone else do it better?	Improve the sequence or output.
Method	How?	How is it being done? Is there a better way?	Simplify tasks, improve output.
Cost	How much?	How much does it cost now? What would the new cost be?	Select an improved method.

Source: Adapted from Alan Robinson, ed., *Continuous Improvement in Operations: A Systematic Approach to Waste Reduction*, p. 246. Copyright © 1991 Productivity Press. www.productivitypress.com.

5W2H approach A method of asking questions about a process that includes what, why, where, when, who, how, and how much.

Process Improvement Using 5W2H

Asking certain questions about a process can lead to cost and waste reduction. The **5W2H approach** (five questions that begin with *w*, and two questions that begin with *h*) is outlined in Table 14.4. This approach can be used by itself or in conjunction with value stream mapping.

Lean and Six Sigma

Some believe that lean and Six Sigma are two alternate approaches for process improvement. However, another view is that the two approaches are complementary and, when used together, can lead to superior results.

Lean strives to eliminate non-value-added activities, using simple tools to find and eliminate them. It focuses on maximizing process velocity, and it employs tools to analyze and improve process flow. However, variation exists in all processes. Understanding and reducing variation are important for quality improvement. Lean principles alone cannot achieve statistical process control, and Six Sigma alone cannot achieve improved process speed and flow. Using the two approaches in combination integrates lean principles and Six Sigma statistical tools for variation reduction to achieve a system that has both a balanced flow and quality.

JIT Deliveries and the Supply Chain

Direct suppliers must be able to support frequent just-in-time deliveries of small batches of parts. That may lead to an increase in transportation costs if trucks carry partial loads, and perhaps to congestion at loading docks. Moreover, the JIT delivery requirement may extend to other portions of the supply chain, in which case close coordination among supply chain partners is critical. Also, JIT delivery results in pressure for on-time deliveries to avoid production interruptions due to stockouts.

Lean and ERP

Lean systems focus on pacing production and synchronizing delivery of incoming supply. SAP's Lean Planning and Operations module extends ERP to lean operation by providing lean planning and scheduling capability linked to customer demand. It enables leveling of schedules and synchronization of supply chain activities with paced company operations.

**BY LISA SPENCER**

The Japanese term “gemba” translates to “actual place.” It means that in order to know what is going on, you need to go to the *locations* where the operations occur.

Lean practitioners apply the Japanese technique to stay in touch with what is happening on the factory floor. Possible reasons for a gemba walk include learning about work practices, coaching employees, or following up on issues identified in the past. While there are no set rules on how to conduct a gemba walk, some general guidelines for success are:

- Have a purpose. Identify the processes, people, or products to be studied.
- Keep it brief. Thirty to 45 minutes should be long enough to accomplish the purpose of the walk.
- Drive out fear. Develop a culture where employees are glad to see the gemba walker and are excited to share their ideas for improvements.

Gemba expert Ron Pereira warns that one of the biggest mistakes made with gemba is to just wander about the plant floor on a meet-and-greet basis, handing out pats on the back or empty praise to employees, instead of taking time to understand what is going on.

While walking can be helpful, so can an occasional pause. Taiichi Ohno, father of the Toyota Production System of lean manufacturing, paid frequent visits to the factory floor. As he walked, he would stop from time to time to observe what was happening around him. He felt this gave him a better perspective than continually walking about.

If used correctly, gemba walks offer leaders and managers a way to stay in touch with the pulse of activities on the factory floor and make decisions that include employee input and concerns.

Questions

1. What benefits can companies glean from incorporating gemba walks into their lean practices?
2. How are gemba walks different than value stream mapping?
3. Why do you think many organizations make decisions without attempting to understand what is happening on the factory floor?

Based on

Austin Weber, “Daily Walking Is a Healthy Activity in Lean Plants,” *Assembly Magazine*, May 3, 2018, <https://www.assemblymag.com/articles/94291-daily-walking-is-a-healthy-activity-in-lean-plants>

14.5 TRANSITIONING TO A LEAN SYSTEM

The success of lean systems in Japan and the United States has attracted keen interest among other traditional manufacturers.

Planning a Successful Conversion

To increase the probability of successful transition, companies should adopt a carefully planned approach that includes the following elements:

1. Make sure top management is committed to the conversion and they know what will be required. Be sure management is involved in the process and knows what it will cost, how long it will take to complete the conversion, and what results can be expected.
2. Study the operations carefully; decide which parts will need the most effort to convert.
3. Obtain the support and cooperation of workers. Prepare training programs that include sessions in setups, maintenance of equipment, cross-training for multiple tasks, cooperation, and problem solving. Make sure workers are fully informed about what lean is and why it is desirable. Reassure workers that their jobs are secure.
4. Begin by trying to reduce setup times while maintaining the current system. Enlist the aid of workers in identifying and eliminating existing problems (e.g., bottlenecks, poor quality).
5. Gradually convert operations, beginning at the *end* of the process and working *backward*. At each stage, make sure the conversion has been relatively successful before moving on. Do not begin to reduce inventories until major problems have been resolved.
6. As one of the last steps, convert suppliers to JIT and be prepared to work closely with them. Start by narrowing the list of vendors, identifying those who are willing to embrace the lean philosophy. Give preference to vendors who have long-term track

LO14.10 Outline considerations for successful conversion from a traditional system to a lean system.

records of reliability. Use vendors located nearby if quick response time is important. Establish long-term commitments with vendors. Insist on high standards of quality and adherence to strict delivery schedules.

7. Be prepared to encounter obstacles to conversion.

LO14.11 Describe some of the obstacles to lean success.

Obstacles to Conversion

Converting from a traditional system to a lean system may not be smooth. For example, *cultures* vary from organization to organization. Some cultures relate better to the lean philosophy than others. If a culture doesn't relate, it can be difficult for an organization to change its culture within a short time. Also, manufacturers that operate with large amounts of inventory to handle varying customer demand may have difficulty acclimating themselves to less inventory.

Some other obstacles include the following:

1. Management may not be totally committed or may be unwilling to devote the necessary resources to conversion. This is perhaps the most serious impediment because the conversion is probably doomed without serious commitment.
2. Workers and/or management may not display a cooperative spirit. The system is predicated on cooperation. Managers may resist because lean shifts some of the responsibility from management to workers and gives workers more control over the work. Workers may resist because of the increased responsibility and stress.
3. It can be very difficult to change the culture of the organization to one consistent with the lean philosophy.
4. Suppliers may resist for several reasons:
 - a. Buyers may not be willing to commit the resources necessary to help them adapt to the lean systems.
 - b. They may be uneasy about long-term commitments to a buyer.
 - c. Frequent, small deliveries may be difficult, especially if the supplier has other buyers who use large deliveries, or the supplier is not near.
 - d. The burden of quality control will shift to the supplier.
 - e. Frequent engineering changes may result from continuing lean improvements by the buyer.

A Cooperative Spirit

Lean systems require a cooperative spirit among workers, management, and vendors. Unless that is present, it is doubtful that a truly effective lean system can be achieved. The Japanese have been very successful in this regard, partly because respect and cooperation are ingrained in the Japanese culture. In Western cultures, workers, managers, and vendors have historically been strongly at odds with each other. Consequently, a major consideration in converting to a lean system is whether a spirit of mutual respect and cooperation can be achieved. This requires an appreciation of the importance of cooperation and a tenacious effort by management to instill and maintain that spirit.

Finally, it should be noted that not all organizations lend themselves to a lean approach. Lean is best used for repetitive operations under fairly stable demand.

Despite the many advantages of lean production systems, an organization must take into account a number of other considerations when planning a conversion.

The key considerations are the time and cost requirements for successful conversion, which can be substantial. But it is absolutely essential to eliminate the major sources of disruption in the system. Management must be prepared to commit the resources necessary to achieve a high level of quality and to function on a tight schedule. That means attention to even the

smallest of details during the design phase and substantial efforts to debug the system to the point where it runs smoothly. Beyond that, management must be capable of responding quickly when problems arise, and both management and workers must be committed to the continuous improvement of the system. Although each case is different, a general estimate of the time required for conversion is one to three years.

14.6 LEAN SERVICES

The discussion of lean systems has focused on manufacturing simply because that is where it was developed, and where it has been used most often. It is important to recognize that the full spectrum of lean benefits are more difficult to achieve in service operations. Nonetheless, services can and do benefit from many lean concepts. When just-in-time is used in the context of services, the focus is often on the time needed to perform a service—because speed is often an important order winner for services. Some services do have inventories of some sort, so inventory reduction is another aspect of lean that can apply to services. Examples of speedy delivery (“available when requested”) are Domino’s Pizza, FedEx and Express Mail, fast-food restaurants, and emergency services. Other examples include just-in-time publishing and work cells at fast-food restaurants.

In addition to speed, lean services emphasize consistent, high-quality, standard work methods; flexible workers; and close supplier relationships.

Process improvement and problem solving can contribute to streamlining a system, resulting in increased customer satisfaction and higher productivity. The following are the ways lean benefits can be achieved in services:

- **Eliminate disruptions.** For example, try to avoid having workers who are servicing customers also answer telephones.
- **Make the system flexible.** This can cause problems unless approached carefully. Often, it is desirable to standardize work because that can yield high productivity. On the other hand, being able to deal with variety in task requirements can be a competitive advantage. One approach might be to train workers so they can handle more variety.



Conner Flecks/Alamy Stock Photo

The Pyxis® ProcedureStation™ system provides rapid access to inventory in the operating room, cath and cardiac labs, and other specialty departments. Usage, inventory, and replenishment information are transmitted electronically, creating an efficient supply management and workflow process.

Another might be to assign work according to specialties, with certain workers handling different types of work according to their specialty.

- **Reduce setup times and processing times.** Have frequently used tools and spare parts readily available. Additionally, for service calls, try to estimate which parts and supplies might be needed so they will be on hand, and avoid carrying huge inventories.
- **Eliminate waste.** This includes errors and duplicate work. Keep the emphasis on quality and uniform service.
- **Minimize work-in-process.** Examples include orders waiting to be processed, calls waiting to be answered, packages waiting to be delivered, trucks waiting to be unloaded or loaded, applications waiting to be processed.
- **Simplify the process.** This works especially well when customers are part of the system (self-service systems including retail operations, ATMs and vending machines, service stations, etc.).

JIT service can be a major competitive advantage for companies that can achieve it. An important key to JIT service is the ability to provide service when it is needed. That requires flexibility on the part of the provider, which generally means short setup times, and it requires clear communication on the part of the requester. If a requester can determine when it will need a particular service, a JIT server can schedule deliveries to correspond to those needs, eliminating the need for continual requests, and reducing the need for provider flexibility—and therefore probably reducing the cost of the JIT service.

Although lean concepts are applicable to service organizations, the challenge of implementing lean in service is that there are still relatively few lean service applications that service companies can reference to see how to apply the underlying lean principles. Consequently, it can be difficult to build a strong commitment among workers to achieve a lean service system.

14.7 JIT II

In some instances, companies allow *suppliers* to manage restocking of inventory obtained from the suppliers. A supplier representative works right in the company's plant, making sure there is an appropriate supply on hand. The term *JIT II* is used to refer to this practice, and was popularized by the Bose Corporation. The concept is often referred to as *vendor-managed inventory (VMI)*. You can read more about vendor-managed inventories in the supply chain management chapter (Chapter 15).

14.8 OPERATIONS STRATEGY

The lean operation offers new perspectives on operations that must be given serious consideration by managers in repetitive and batch systems who wish to be competitive.

Potential adopters should carefully study the requirements and benefits of lean production systems, as well as the difficulties and strengths of their current systems, before making a decision on whether to convert. Careful estimates of time and cost to convert, and an assessment of how likely workers, managers, and suppliers will cooperate in such an approach, are essential.

The decision to convert can be sequential, giving management an opportunity to gain first-hand experience with portions of lean operations without wholly committing themselves. For instance, improving vendor relations, reducing setup times, improving quality, and reducing waste and inefficiency are desirable goals in themselves. Moreover, a level production schedule is a necessary element of a lean system, and achieving that will also be useful under a traditional system of operation.

It is prudent to carefully weigh the risks and benefits of a just-in-time approach to inventories. A just-in-time approach can make companies and even countries vulnerable to disruptions in their supply chains. For example, low stockpiles of flu vaccine at hospitals lower their costs but leave the health system at risk if there is a flu outbreak. Also, severe weather such as hurricanes, floods, and tornadoes, and other natural disasters caused by earthquakes can cut off supply routes, leaving community services, as well as companies, desperately in need of supplies.

Supplier management is critical to a JIT operation. Generally, suppliers are located nearby to facilitate delivery on a daily or even hourly basis. Moreover, suppliers at every stage must gauge the ability of their production facilities to meet demand requirements that are subject to change.

Finally, the success of a lean system relies heavily on leadership commitment, involvement, and support, achieving a lean thinking “culture” that includes everyone in the organization, and having effective teamwork. Without these three elements, the full benefits of lean are not likely to be realized.

Lean operation is an alternative to traditional operations that an increasing number of organizations are adopting. The ultimate goal of a lean system is to achieve a balanced, smooth flow of operations. Supporting goals include eliminating disruptions to the system, making the system flexible, and eliminating waste. The building blocks of a lean production system are product design, process design, personnel and organization, and manufacturing planning and control.

Lean systems require the elimination of sources of potential disruption to the even flow of work. High quality is essential because problems with quality can disrupt the process. Quick low-cost setups, special layouts that allow work to be pulled through the system rather than pushed through, and a spirit of cooperation are important features of lean systems. So, too, are problem solving aimed at reducing disruptions and making the system more efficient, and an attitude of working toward continual improvement.

Key benefits of lean systems are reduced inventory levels, high quality, flexibility, reduced lead times, increased productivity and equipment utilization, reduced amounts of scrap and rework, and reduced space requirements. The risks stem from the absence of buffers, such as extra personnel and inventory stockpiles to fall back on if something goes wrong. The possible results of risks include lost sales and lost customers.

Just-in-time (JIT) is a system of lean production used mainly in repetitive operations, in which goods move through the system and tasks are completed just in time to maintain the schedule. JIT systems require very little inventory because successive operations are closely coordinated. Careful planning and much effort are needed to achieve a smoothly functioning system in which all resources needed for production come together at precisely the right time throughout the process. Raw materials and purchased parts must arrive when needed, fabricated parts and subassemblies must be ready when needed for final assembly, and finished goods must be delivered to customers when needed. Special attention must be given to reducing the risk of disruptions to the system, as well as rapid response to resolving any disruptions that do occur. Usually, a firm must redesign its facilities and rework labor contracts to implement lean operation. Teamwork and cooperation are important at all levels, as are problem-solving abilities of workers and an attitude of continuous improvement.

Table 14.5 provides an overview of lean.

1. Lean systems produce high-quality goods or services using fewer resources than traditional operations systems.
2. Lean thinking helps business organizations become more productive, reduce costs, and be more market-responsive.
3. Lean operations are designed to eliminate waste (value stream mapping), minimize inventory (JIT deliveries), maximize work flow (small batches with quick changeovers), make only what is needed (demand pull), empower work teams, do it right the first time (quality at the source), and continually improve.

SUMMARY

KEY POINTS

TABLE 14.5
Overview of lean.

Lean systems are designed to operate with fewer resources than traditional systems. Elements of lean operation include:

- Smooth flow of work (the ultimate goal)
- Elimination of waste
- Continuous improvement
- Elimination of anything that does not add value
- Simple systems that are easy to manage
- Use of product layouts that minimize time spent moving materials and parts
- Quality at the source: Each worker is responsible for the quality of his or her output
- Poka-yoke*: fail-safe tools and methods to prevent mistakes
- Preventive maintenance to reduce the risk of equipment breakdown
- Good housekeeping: an orderly and clean workplace
- Setup time reduction
- Cross-trained workers
- A pull system

There are eight types of waste:

- Inventory
- Overproduction
- Waiting time
- Excess transportation
- Processing waste
- Inefficient work methods
- Product or service defects
- Underused people

KEY TERMS

5W2H approach, 634
activity-based costing, 624
andon, 623
autonomation, 619
heijunka, 613
housekeeping, 632
jidoka, 613

just-in-time (JIT), 611
kaizen, 613
kanban, 613, 627
lean operation, 611
muda, 613
poka-yoke, 622
preventive maintenance, 632

pull system, 626
push system, 626
single-minute exchange of die (SMED), 618
takt time, 620
value stream mapping, 632

SOLVED PROBLEMS

Problem 1 Determine the number of containers needed for a workstation that uses 100 parts per hour if the time for a container to complete a cycle (move, wait, empty, return, fill) is 90 minutes and a standard container holds 84 parts. An inefficiency factor of .10 is currently being used.

Solution $N = ?$

$D = 100$ parts per hour

$T = 90$ minutes (1.5 hours)

$C = 84$ parts

$X = .10$

$$N = \frac{D(T)(1 + X)}{C} = \frac{100(1.5)(1 + .10)}{84} = 1.96; \text{ round to 2 containers}$$

Problem 2 Determine the number of cycles per day and the production quantity per cycle for this set of products. The department operates five days a week. Assume the sequence A-B-C-D will be used.

Product	Weekly Quantity
A	20
B	40
C	30
D	15

Convert weekly quantities to daily quantities. The smallest *daily* quantity is 3 units. Producing in multiples of 3 units leaves A and B a few units short:

Solution

Product	Daily Quantity = Weekly Quantity \div 5	Units Short Using 3 Cycles
A	$20 \div 5 = 4$	1
B	$40 \div 5 = 8$	2
C	$30 \div 5 = 6$	—
D	$15 \div 5 = 3$	—

Use three cycles, producing all four products in every cycle. Produce units that are short by adding units to some cycles. Disperse the additional units as evenly as possible. There are several possibilities. One is as follows.

Cycle	1	2	3
Pattern	A B(3) C(2) D	A B(3) C(2) D	A(2) B(2) C(2) D
Extra unit(s)	B	B	A

- Some key elements of production systems are listed in Table 14.3. Explain briefly how lean systems differ from traditional production systems for each of those elements.
- What is the ultimate goal of a lean system? What are the supporting goals? What are the building blocks?
- Describe the philosophy that underlies JIT (i.e., what is JIT intended to accomplish?).
- What are some of the main obstacles that must be overcome in converting from a traditional system to lean?
- Briefly discuss vendor relations in lean systems in terms of the following issues:
 - Why are they important?
 - How do they tend to differ from the more adversarial relations of the past?
 - Why might suppliers be hesitant about JIT purchasing?
- Certain Japanese have claimed that Henry Ford's assembly line provided some of the rationale for lean. What features of assembly lines are common to lean systems?
- What is the kanban aspect of JIT?
- Contrast push and pull methods of moving goods and materials through production systems.
- What are the main benefits of a lean system?
- What are the benefits and risks of small lot sizes?

DISCUSSION AND REVIEW QUESTIONS

TAKING STOCK

1. What trade-offs are involved in shifting from a traditional operations system to a lean system for a manufacturing firm? For a service firm?
2. Who in the organization is affected by a decision to shift from a traditional operations system to a lean system?
3. To what extent has technology had an impact on lean systems?

CRITICAL THINKING EXERCISES

1. In operations management, as in life, a balanced approach is often the best policy. One of the best examples of the benefits of this in operations management is the lean approach. Explain the basic factors that must be in place to achieve a balanced lean system.
2. Give three examples of unethical behavior involving lean operations, and state the relevant ethical principle that would be violated.

PROBLEMS

1. A manager wants to determine the number of containers to use for incoming parts for a kanban system to be installed next month. The process will have a usage rate of 80 pieces per hour. Because the process is new, the manager has assigned an inefficiency factor of .35. Each container holds 45 pieces, and it takes an average of 75 minutes to complete a cycle. How many containers should be used? As the system improves, will more or fewer containers be required? Why?
2. A JIT system uses kanban cards to authorize movement of incoming parts. In one portion of the system, a work center uses an average of 100 parts per hour while running. The manager has assigned an inefficiency factor of .20 to the center. Standard containers are designed to hold six dozen parts each. The cycle time for parts containers is about 105 minutes. How many containers are needed?
3. A machine cell uses 200 pounds of a certain material each day. Material is transported in vats that hold 20 pounds each. Cycle time for the vats is about two hours. The manager has assigned an inefficiency factor of .08 to the cell. The plant operates on an eight-hour day. How many vats will be used?
4. Determine the number of cycles per day and the production quantity per cycle for this set of vehicles:

Product	Daily Quantity
A	21
B	12
C	3
D	15

Use the sequence A-B-C-D.

5. Given this set of daily service operations, and assuming a processing order of A-B-C-D-E:
 - a. Give one reason that each arrangement might be preferred over the other.
 - b. Determine the number of repetitions for each service if four cycles are used.
 - c. Determine the number of repetitions for each service if two cycles are used.

Service Operation	Number of Daily Reps
A	22
B	12
C	4
D	18
E	8

6. Determine the number of cycles per day and a production quantity per cycle for this set of products that achieves fairly level production:

Product	Daily Quantity
F	9
G	8
H	5
K	6

Assume the production sequence will be F-G-H-K.

7. Compute the *takt* time for a system where the total time per shift is 480 minutes, there is one shift, and workers are given two 15-minute breaks and 45 minutes for lunch. Daily demand is 300 units.
8. What cycle time would match capacity and demand if demand is 120 units a day, there are two shifts of 480 minutes each, and workers are given three half-hour breaks during each shift, one of which is for lunch or dinner?
9. Compute the *takt* time for a service system that intended to perform a standardized service. The system will have a total work time of 440 minutes per day, two 10-minute breaks, and an hour for lunch. The service system must process 90 jobs a day.

CASE



LEVEL OPERATIONS

Level Operations is a small company located in eastern Pennsylvania. It produces a variety of security devices and safes. The safes come in several different designs. Recently, a number of new customers have placed orders, and the production facility has been enlarged to accommodate increased demand for safes. Production manager Stephanie Coles is currently working on a production plan for the safes. She needs a plan for each day of the week. She has obtained the following information from the marketing department on projected demand for the next five weeks.

Model	S1	S2	S7	S8	S9
Weekly Quantity	120	102	48	90	25

The department operates five days a week. One complexity is that partially completed safes are not permitted; each cycle must turn out finished units.

After discussions with engineering, Stephanie determined that the best production sequence for each cycle is S7-S8-S9-S1-S2.

Question

What might Stephanie determine as the best production quantity per cycle for each day of the week?



The Boeing Company, headquartered in Chicago, Illinois, is one of the two major producers of aircraft in the global market. The other major producer is European Airbus.

Boeing produces planes in Everett, Washington. The planes are all produced in the same building. At any one time, there may be as many as six planes in various stages of production. Obviously, the building must be fairly large to accommodate such a huge undertaking. In fact, the building is so large that it covers over 98 acres and is four stories high, making it the largest building by volume in the world. It is so big that all of Disneyland would fit inside, and still leave about 15 acres for indoor parking! The windowless building has six huge doors along one side, each about 100 yards wide and 40 yards high (the size of a football field)—large enough to allow a completed airplane to pass through.

Boeing sells airplanes to airlines and countries around the globe. There isn't a set price for the planes; the actual price depends on what features the customer wants. Once the details have been settled and an order submitted, the customer requirements are sent to the design department.

Design

Designers formerly had to construct a mock-up to determine the exact dimensions of the plane and to identify any assembly problems that might occur. That required time, materials, labor, and space. Now they use computers (CAD) to design airplanes, avoiding the cost of the mock-ups and shortening the development time.

The Production Process

Once designs have been completed and approved by the customer, production of the plane is scheduled, and parts and materials are ordered. Parts come to the plant by rail, airplane, and truck, and are delivered to the major assembly area of the plane they will be used for. The parts are scheduled so they arrive at the plant just prior to when they will be used in assembly, and immediately moved to storage areas close to where they will be used. Time-phasing shipments to arrive as parts are needed helps to keep inventory investment low and avoids having to devote space to store parts that won't be used immediately.

There is a trade-off, though, because if any parts are missing or damaged and have to be reordered, that could cause production delays. When missing or defective parts are discovered, they are assigned priorities according to how critical the part is in terms of disruption of the flow of work. The parts with the highest priorities are assigned to expeditors who determine the best way to replace the part. The expeditors keep track of the progress of the parts and deliver them to the appropriate location as soon as they arrive.

In the meantime, a portion of the work remains unfinished, awaiting the replacement parts, and workers complete other portions of the assembly. If the supplier is unable to replace the part in a time frame that will not seriously delay assembly, as a last resort Boeing has a machine shop that can make the necessary part.

The partially assembled portions of the plane, and in later stages, the plane itself, move from station to station as the work progresses, staying about five days at each station. Giant overhead cranes are used to move large sections from one station to

the next, although once the wheel assemblies have been installed, the plane is towed to the remaining stations.

Finished planes are painted in one of two separate buildings. Painting usually adds 400 to 600 pounds to the weight of a plane. The painting process involves giving the airplane a negative charge and the paint a positive charge so that the paint will be attracted to the airplane.

Testing and Quality Control

Boeing has extensive quality control measures in place throughout the entire design and production process. Not only are there quality inspectors, individual employees inspect their own work and the work previously done by others on the plane. Buyers' inspectors also check the quality of the work. However, in light of several crashes of Boeing aircraft in recent years, there has been an increased attention both to inspections and to pilot training.

There are 60 test pilots who fly the planes. Formerly, planes were tested to evaluate their flight worthiness in a wind tunnel, which required expensive testing and added considerably to product development time. Now, new designs are tested using a computerized wind tunnel before production even begins, greatly reducing both time and cost. And in case you're wondering, the wings are fairly flexible; a typical wing can flap by as much as 22 feet before it will fracture.

Re-engineering

Boeing is re-engineering its business systems. A top priority is to upgrade its computer systems. This will provide better links to suppliers, provide more up-to-date information for materials management, and enable company representatives who are at customer sites to create a customized aircraft design on their laptop computer.

Another aspect of the re-engineering involves a shift to lean production. Key goals are to reduce production time and reduce inventory.

Boeing wants to reduce the time that a plane spends at each work station from 5 days to 3 days, a reduction of 40 percent. Not only will that mean customers can get their planes much sooner, it will also reduce labor costs and inventory costs, and improve cash flow. One part of this will be accomplished by moving toward late-stage customization, or delayed differentiation. That would mean standardizing the assembly of planes as long as possible before adding custom features. This, and other time-saving steps, will speed up production considerably, giving it a major competitive advantage.

Boeing also wants to reduce the tremendous amount of inventory it carries (a 747 jumbo jet has about 6 million parts, including 3 million rivets). One part of the plan is to have suppliers do more pre-delivery work by assembling the parts into kits that are delivered directly to the staging area where they will be installed on the aircraft, instead of delivering separate parts to inventory. That would cut down on inventory carrying costs and save time.

Boeing is also hoping to reduce the number of suppliers it has, and to establish better links and cooperation from suppliers. Currently, Boeing has about 3,500 suppliers. Compare that with GM's roughly 2,500 suppliers, and you get an idea of how large this number is.

- Chalice, Robert. *Improving Healthcare Using Toyota Lean Production Methods: 46 Steps for Improvement*, 2nd ed. Milwaukee: ASQ Quality Press, 2007.
- Hopp, Wallace J., and Mark Spearman. *Factory Physics: Foundations of Manufacturing Management*, 3rd ed. Waveland Press, 2011.
- Imai, Masaaki. *Gemba-Kaizen*, 2e. New York: McGraw-Hill, 2012.
- Jacobs, F. Robert, William L. Berry, D. Clay Whybark, and Thomas E. Vollmann. *Manufacturing Planning and Control Systems for Supply Chain Management*, 6th ed. New York: Irwin/McGraw-Hill, 2011.
- Liker, Jeffrey. *The Toyota Way: 14 Management Principles from the World's Greatest Manufacturer*. New York: McGraw-Hill, 2004.
- Liker, Jeffery K., and Gary Convis. *The Toyota Way to Lean Leadership: Achieving and Sustaining Excellence through Leadership Development*. New York: McGraw-Hill, 2011.
- Mann, David. *Creating a Lean Culture: Tools to Sustain Lean Conversions*. New York: Productivity Press, 2005.
- Monden, Yasuhiro. "What Makes the Toyota Production System Really Tick?" *Industrial Engineering*, 13, no. 1 (January 1981), pp. 38–46.
- Pascal, Dennis. *Lean Production Simplified*, 3e. CRC Press, 2015.
- Rother, Mike, and John Shook. *Learning to See*. Cambridge, MA: The Lean Institute, 2009.
- Shingo, Shigeo. *Non-Stock Production: The Shingo System for Continuous Improvement*. New York: Productivity Press, 2006.
- Spear, Steven, and H. Kent Bowen. "Decoding the DNA of the Toyota Production System." *Harvard Business Review*, 77, no. 5 (Sept–Oct, 1999).
- Swank, Cynthia Karen. "The Lean Service Machine." *Harvard Business Review*, October 2003, pp. 123–29.
- Taghizadegan, Salman. *Essentials of Lean Six Sigma*. Burlington, MA: Butterworth-Heinemann, 2006.
- Womack, James P., and Daniel T. Jones. *Lean Thinking: Banish Waste and Create Wealth in Your Corporation*. New York: Free Press, 2003.
- Womack, James P., Daniel T. Jones, and Daniel Roos. *The Machine That Changed the World*. New York: Simon & Schuster, 2007.

**SELECTED
BIBLIOGRAPHY AND
FURTHER READINGS**

14 Maintenance

SUPPLEMENT

LEARNING OBJECTIVES

After completing this supplement, you should be able to:

- LO14S.1** Explain the importance of maintenance in production systems.
- LO14S.2** Describe the range of maintenance activities.
- LO14S.3** Discuss preventive maintenance and the key issues associated with it.
- LO14S.4** Explain breakdown maintenance and name the key issues associated with it.
- LO14S.5** State how the Pareto phenomenon pertains to maintenance decisions.

SUPPLEMENT OUTLINE

- CHAPTER 14S.1** Introduction 646
- CHAPTER 14S.2** Preventive Maintenance 648
- CHAPTER 14S.3** Breakdown Programs 650
- CHAPTER 14S.4** Replacement 650

Maintaining the production capability of an organization is an important function in any production system. **Maintenance** encompasses all those activities that relate to keeping facilities and equipment in good working order and making necessary repairs when breakdowns occur, so that the system can perform as intended.

Maintenance activities are often organized into two categories: (1) buildings and grounds and (2) equipment maintenance. Buildings and grounds is responsible for the appearance and functioning of buildings, parking lots, lawns, fences, and the like. Equipment maintenance is responsible for maintaining machinery and equipment in good working condition and making all necessary repairs.

Maintenance All activities that maintain facilities and equipment in good working order so that a system can perform as intended.

14S.1 INTRODUCTION

LO14S.1 Explain the importance of maintenance in production systems.

The goal of maintenance is to keep the production system in good working order at minimal cost. There are several reasons for wanting to keep equipment and machines in good operating condition, such as to:

- Avoid production or service disruptions
- Not add to production or service costs
- Maintain high quality
- Avoid missed delivery dates

When breakdowns occur, there are a number of potential adverse consequences:

- Operations capacity is reduced, so processing is delayed or takes longer, keeping customers waiting.
- Overhead continues, increasing the cost per unit.
- There can be quality issues; output may be damaged.
- There are safety issues; employees or customers may be injured.

Decision makers have two basic options with respect to maintenance. One option is *reactive*: It is to deal with breakdowns or other problems when they occur. This is referred to as **breakdown maintenance**. The other option is *proactive*: It is to reduce breakdowns through a program of lubrication, adjustment, cleaning, inspection, and replacement of worn parts. This is referred to as **preventive maintenance**.

Decision makers try to make a trade-off between these two basic options that will minimize their combined cost. With no preventive maintenance, breakdown and repair costs would be tremendous. Furthermore, hidden costs, such as lost output and the cost of wages while equipment is not in service, must be factored in. So must the cost of injuries or damage to other equipment and facilities or to other units in production. However, beyond a certain point, the cost of preventive maintenance activities exceeds the benefit.

As an example, if a person never had the oil changed in his or her car, and never had the brakes or tires inspected, but simply had repairs done when absolutely necessary, preventive costs would be negligible but repair costs would be quite high, considering the wide range of parts (engine, steering, transmission, tires, brakes, etc.) that could fail. In addition, property damage and injury costs might be incurred, plus there would be the uncertainty of when failure might occur (e.g., on the expressway during rush hour, or late at night). On the other hand, having the oil changed and the car lubricated every morning would obviously be excessive because automobiles are designed to perform for much longer periods without oil changes and lubrications. The best approach is to seek a balance between preventive maintenance and breakdown maintenance. The same concept applies to maintaining production systems: Strike a balance between prevention costs and breakdown costs. This concept is illustrated in Figure 14S.1.

The age and condition of facilities and equipment, the degree of technology involved, the type of production process, and similar factors enter into the decision of how much preventive maintenance is desirable. Thus, in the example of a new automobile, little preventive maintenance may be needed because there is only a slight risk of breakdowns. As the car ages and becomes worn through use, the desirability of preventive maintenance increases because the risk of breakdown increases. Thus, when tires and brakes begin to show signs of wear,

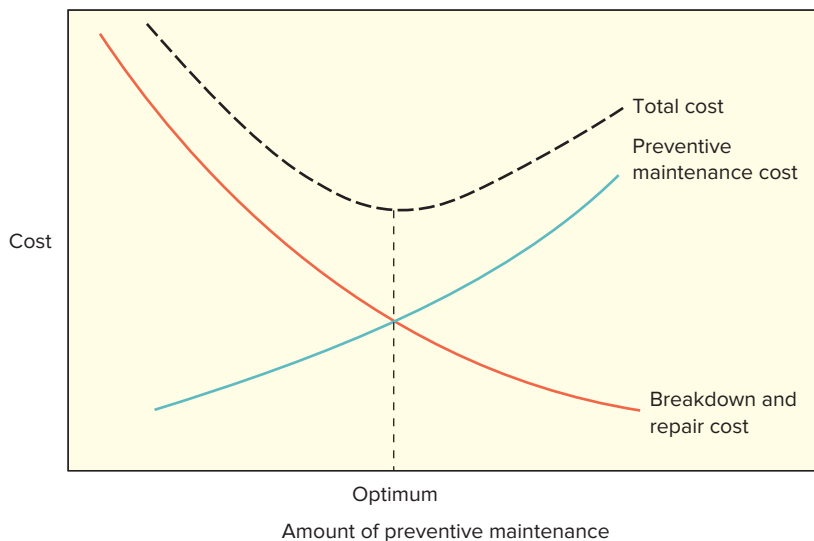

Breakdown maintenance

Reactive approach; dealing with breakdowns or problems when they occur.

Preventive maintenance

Proactive approach; reducing breakdowns through a program of lubrication, adjustment, cleaning, inspection, and replacement of worn parts.

FIGURE 14S.1

Total maintenance cost as a function of preventive maintenance effort

they should be replaced before they fail; dents and scratches should be periodically taken care of before they begin to rust; and the car should be lubricated and have its oil changed after exposure to high levels of dust and dirt. Also, inspection and replacement of critical parts that tend to fail suddenly should be performed before a road trip to avoid disruption of the trip and costly emergency repair bills.

14S.2 PREVENTIVE MAINTENANCE

LO14S.2 Describe the range of maintenance activities.

The goal of preventive maintenance is to reduce the incidence of breakdowns or failures in the plant or equipment to avoid the associated costs. Those costs can include loss of output; idle workers; schedule disruptions; injuries; damage to other equipment, products, or facilities; and repairs, which may involve maintaining inventories of spare parts, repair tools and equipment, and repair specialists.

Preventive maintenance is *periodic*. It can be scheduled according to the availability of maintenance personnel and to avoid interference with operating schedules. Managers usually schedule preventive maintenance using some combination of the following:

- The result of planned inspections that reveal a need for maintenance
- According to the calendar (passage of time)
- After a predetermined number of operating hours, or units produced

An important issue in preventive maintenance is the frequency of preventive maintenance. As the time between periodic maintenance episodes increases, the cost of preventive maintenance decreases, while the risk (and cost) of breakdowns increases. As noted, the goal is to strike a balance between the two costs (i.e., to minimize total cost).

Determining the amount of preventive maintenance to use is a function of the expected frequency of breakdown, the cost of a breakdown (including actual repair costs as well as potential damage or injury, lost production, and so on). The following two examples illustrate this.

EXAMPLE 14S-1

eXcel

mhhe.com/stevenson14e

Comparing the Costs of Preventive Maintenance and Breakdown Maintenance

The frequency of breakdown of a machine per month is shown in the table. The cost of a breakdown is \$1,000 and the cost of preventive maintenance is \$1,250 per month. If preventive maintenance is performed, the probability of a machine breakdown is negligible. Should the manager use preventive maintenance, or would it be cheaper to repair the machine when it breaks down?

Number of breakdowns	0	1	2	3
Frequency of occurrence	.20	.30	.40	.10

SOLUTION

The expected number of breakdowns without preventive maintenance is 1.40:

Number of Breakdowns	×	Frequency of Occurrence	=	Expected Number of Breakdowns
0		.20		0
1		.30		.30
2		.40		.80
3		.10		.30
		1.00		1.40

Expected cost using repair policy is 1.40 breakdowns/month \times \$1,000/breakdown = \$1,400. Preventive maintenance would cost \$1,250.

Therefore, preventive maintenance would yield a savings of \$150/month.

Comparing Preventive Maintenance and Breakdown Maintenance When Breakdown Time Is Normally Distributed

EXAMPLE 14S-2

Another approach that might be used relates to the time before a breakdown occurs. Suppose the average time before breakdown is normally distributed and has a mean of 3 weeks and a standard deviation of .60 week. If breakdown cost averages \$1,000 and preventive maintenance costs \$250, what is the optimal maintenance interval?

Begin by computing the ratio of preventive cost to the breakdown cost:

$$\frac{\text{Preventive cost}}{\text{Breakdown cost}} = \frac{\$250}{\$1,000} = .25$$

Find the number of standard deviations from the mean represented by an area under the normal curve equal to .25 using Appendix B, Table B. It is $-.67$. Use this value of z to compute the maintenance interval:

$$\text{Mean} + z \text{ standard deviations} = 3 - .67(.60) = 2.598 \text{ (round to 2.6 weeks)}$$

SOLUTION

Ideally, preventive maintenance will be performed just prior to a breakdown or failure because this will result in the longest possible use of facilities or equipment without a breakdown. **Predictive maintenance** is an attempt to determine when to perform preventive maintenance activities. It is based on historical records and analysis of technical data to predict when a piece of equipment or part is about to fail. The better the predictions of failures are, the more effective preventive maintenance will be. A good preventive maintenance effort relies on complete records for each piece of equipment. Records must include information such as date of installation, operating hours, dates and types of insurance, and dates and types of repairs.

Some companies have workers perform preventive maintenance on the machines they operate, rather than use separate maintenance personnel for that task. Called **total productive maintenance**, this approach is consistent with JIT systems and lean operations, where employees are given greater responsibility for quality, productivity, and the general functioning of the system.

In the broadest sense, preventive maintenance extends back to the design and selection stage of equipment and facilities. Maintenance problems are sometimes *designed into* a system. For example, equipment may be designed in such a way that it needs frequent maintenance, or maintenance may be difficult to perform (e.g., the equipment has to be partially dismantled in order to perform routine maintenance). An extreme example of this was a certain car model that required the engine block to be lifted slightly to change the spark plugs! In such cases, maintenance is very likely to be performed less often than if its performance were less demanding. In other instances, poor design can cause equipment to wear out at an early age or experience a much higher than expected breakdown rate. *Consumer Reports*, for example, publishes annual breakdown data on automobiles. The data indicate that some models tend to break down with a much higher frequency than others.

One possible reason for maintenance problems being designed into a product is that designers have considered other aspects of design more important. Cost is one such aspect. Another is appearance; an attractive design may be chosen over a less attractive one even though it will be more demanding to maintain. Customers may contribute to this situation; the buying public probably has a greater tendency to select an attractive design over one that offers ease of maintenance.

Obviously, durability and ease of maintenance can have long-term implications for preventive maintenance programs. Training of employees in proper operating procedures and in how to keep equipment in good operating order—and providing the incentive to do so—are also important. More and more, U.S. organizations are taking a cue from the Japanese and transferring routine maintenance (e.g., cleaning, adjusting, inspecting) to the users of equipment,

Predictive maintenance An attempt to determine when best to perform preventive maintenance activities.

Total productive maintenance JIT approach where workers perform maintenance on the machines they operate.

in an effort to give them a sense of responsibility and awareness of the equipment they use and to cut down on abuse and misuse of the equipment.

14S.3 BREAKDOWN PROGRAMS

LO14S.3 Discuss preventive maintenance and the key issues associated with it.

The risk of a breakdown can be greatly reduced by an effective preventive maintenance program. Nonetheless, occasional breakdowns still occur. Even firms with good preventive practices have some need for breakdown programs. Of course, organizations that rely less on preventive maintenance have an even greater need for effective ways of dealing with breakdowns.

Unlike preventive maintenance, management cannot schedule breakdowns but must deal with them on an irregular basis (i.e., as they occur). Among the major approaches used to deal with breakdowns are the following:

- **Standby or backup equipment** that can be quickly pressed into service.
- **Inventories of spare parts** that can be installed as needed, thereby avoiding lead times involved in ordering parts, and *buffer inventories*, so that other equipment will be less likely to be affected by short-term downtime of a particular piece of equipment.
- **Operators** who are able to perform at least minor repairs on their equipment.
- **Repair people** who are well trained and readily available to diagnose and correct problems with equipment.

LO14S.4 Explain breakdown maintenance and name the key issues associated with it.

The degree to which an organization pursues any or all of these approaches depends on how important a particular piece of equipment is to the overall operations system. At one extreme is equipment that is the focal point of a system (e.g., printing presses for a newspaper, or vital operating parts of a car, such as brakes, steering, transmission, ignition, and engine). At the other extreme is equipment that is seldom used, such as equipment needed for repairs, or equipment for which substitutes are readily available.

LO14S.5 State how the Pareto phenomenon pertains to maintenance decisions.

The implication is clear: Breakdown programs are most effective when they take into account the degree of importance a piece of equipment has in the operations system, and the ability of the system to do without it for a period of time. The Pareto phenomenon exists in such situations: A relatively few pieces of equipment will be extremely important to the functioning of the system, thereby justifying considerable effort and/or expense; some will require moderate effort or expense; and many will justify little effort or expense.

14S.4 REPLACEMENT

When breakdowns become frequent and/or costly, the manager is faced with a trade-off decision in which costs are an important consideration: What is the cost of replacement compared with the cost of continued maintenance? This question is sometimes difficult to resolve, especially if future breakdowns cannot be readily predicted. Historical records may help to project future experience. Another factor is technological change; newer equipment may have features that favor replacement over either preventive or breakdown maintenance. On the other hand, the removal of old equipment and the installation of new equipment may cause disruptions to the system, perhaps greater than the disruptions caused by breakdowns. Also, employees may have to be trained to operate the new equipment. Finally, forecasts of future demand for the use of the present or new equipment must be taken into account. The demand for the replacement equipment might differ because of the different features it has. For instance, demand for output of the current equipment might be two years, while demand for output of the replacement equipment might be much longer.

These decisions can be fairly complex, involving a number of different factors. Nevertheless, most of us are faced with a similar decision with our personal automobiles: When is it time for a replacement?

Maintaining the productive capability of an organization is an important function. Maintenance includes all of the activities related to keeping facilities and equipment in good operating order and maintaining the appearance of buildings and grounds.

The goal of maintenance is to minimize the total cost of keeping the facilities and equipment in good working order. Maintenance decisions typically reflect a trade-off between preventive maintenance, which seeks to reduce the incidence of breakdowns and failures, and breakdown maintenance, which seeks to reduce the impact of breakdowns when they do occur.

breakdown maintenance, 647 predictive maintenance, 649 total productive
 maintenance, 646 preventive maintenance, 647 maintenance, 649

SUMMARY

KEY TERMS

DISCUSSION AND REVIEW QUESTIONS

1. What is the goal of a maintenance program?
 2. List the costs associated with equipment breakdown.
 3. What are three different ways preventive maintenance is scheduled?
 4. Explain the term *predictive maintenance* and the importance of good records.
 5. List the major approaches organizations use to deal with breakdowns.
 6. Explain how the Pareto phenomenon applies to:
 - a. Preventive maintenance
 - b. Breakdown maintenance
 7. Discuss the key points of this supplement as they relate to maintenance of an automobile.
 8. What advantages does preventive maintenance have over breakdown maintenance?
 9. Explain why having a good preventive maintenance program in place is necessary prior to implementing a lean system.
 10. Discuss the relationship between preventive maintenance and quality.
1. The probability that equipment used in a hospital lab will need recalibration is given in the following table. A service firm is willing to perform maintenance and do any necessary calibrations for a fee of \$650 per month. Recalibration costs \$500 per time. Which approach would be most cost-effective, recalibration as needed or the service contract?

Number of Recalibrations	0	1	2	3	4
Probability of Occurrence	.15	.25	.30	.20	.10

2. The frequency of breakdown of a machine that issues lottery tickets is given in the following table. Repairs cost an average of \$240. A service firm is willing to provide preventive maintenance under either of two options: #1 is \$500 and covers all necessary repairs, and #2 is \$350 and covers any repairs after the first one. Which option would have the lower expected cost: pay for all repairs, service option #1, or service option #2?

Number of Breakdowns/Month	0	1	2	3	4
Frequency of Occurrence	.10	.30	.30	.20	.10

3. Determine the optimum preventive maintenance frequency for each of the pieces of equipment if breakdown time is normally distributed:

Equipment	Average Time (days) between Breakdowns	Standard Deviation	Equipment	Preventive Maintenance Cost	Breakdown Cost
A201	20	2	A201	\$300	\$2,300
B400	30	3	B400	\$200	\$3,500
C850	40	4	C850	\$530	\$4,800

PROBLEMS

**SELECTED
BIBLIOGRAPHY AND
FURTHER READINGS**

Lean Practices at EPA. <http://www.epa.gov/lean/environment/methods/tpm.htm>

Palmer, Richard D. *Planning and Scheduling Maintenance*, 3e. New York: McGraw-Hill, 2013.

<http://blog.infraspeak.com/preventive-vs-predictive-maintenance/>

<https://onupkeep.com/blog/differences-between-preventative-predictive-and-breakdown-maintenance/>

15

Supply Chain Management

CHAPTER

LEARNING OBJECTIVES

After completing this chapter, you should be able to:

- LO15.1** Explain the terms *supply chain* and *logistics*.
- LO15.2** Name the key aspects of supply chain management.
- LO15.3** List and briefly explain current trends in supply chain management.
- LO15.4** Outline the benefits and risks related to outsourcing.
- LO15.5** Explain what the main supply chain risks are and what businesses can do to minimize those risks.
- LO15.6** Describe some of the complexities related to global supply chains.
- LO15.7** Briefly describe ethical issues in supply chains and the key steps companies can take to avoid ethical problems.
- LO15.8** Describe the three concerns of small businesses related to the supply chain and suggest ways to manage those concerns.
- LO15.9** List several strategic, tactical, and operational responsibilities related to managing the supply chain.
- LO15.10** Discuss procurement in terms of the purchasing interfaces, the purchasing cycle, ethics, and centralized versus decentralized decision making.
- LO15.11** Briefly describe the key aspects of supplier management.
- LO15.12** Discuss the logistics aspects of supply chain management, including RFID technology.
- LO15.13** Discuss the issues involved in managing returns.
- LO15.14** Describe some of the challenges in creating an effective supply chain and some of the trade-offs involved.

CHAPTER OUTLINE

- | | | |
|---|---|--------------------------------------|
| 15.1 Introduction 656 | 15.5 Ethics and the Supply Chain 664 | The Purchasing Cycle 667 |
| 15.2 Trends in Supply Chain Management 657 | 15.6 Small Businesses 664 | Centralized versus |
| Risk Management and Resiliency 661 | 15.7 Management Responsibilities 665 | Decentralized Purchasing 668 |
| Shortening the Supply Chain 662 | Strategic Responsibilities 666 | Ethics in Purchasing 669 |
| 15.3 Global Supply Chains 663 | Key Tactical and Operational Responsibilities 666 | 15.9 E-Business 670 |
| 15.4 ERP and Supply Chain Management 663 | 15.8 Procurement 667 | 15.10 Supplier Management 671 |
| | Purchasing Interfaces 667 | Choosing Suppliers 671 |
| | | Supplier Audits 671 |
| | | Supplier Certification 672 |



Kevin Phillips/Getty Images

Supplier Relationship Management 672

Supplier Partnerships 673

Strategic Partnering 673

15.11 Inventory Management 674

15.12 Order Fulfillment 675

15.13 Logistics 676

Movement within a Facility 676

Operations Tour: Wegmans' Shipping System 677

Incoming and Outgoing Shipments 678

Getting to the Right Location 678

Tracking Goods: RFID 678

Evaluating Shipping Alternatives 680

3-PL 681

15.14 Creating an Effective Supply Chain 681

Managing Returns 683

Challenges 685

15.15 Strategy 686

Case: MasterTag 689

The Wegmans supermarket chain (see the Wegmans Operations Tour in Chapter 1) is often mentioned as one of the best-run supermarket chains in the United States. It's now being mentioned for its leadership in supply chain management in the grocery industry. When a Wegmans spokesperson was asked how many of its people work in its supply chain, the spokesperson essentially said all of them.

The fact of the matter is that most if not all of the people who work in any business organization are somehow involved with the supply chain. So no matter where your career takes you, in every job you do, you'll be involved in one (or more) supply chain(s).

In this chapter, you will learn about recent trends in supply chain management, key supply chain processes and management responsibilities, procurement, logistics, managing returns, managing risks, and creating an effective supply chain.

15.1 INTRODUCTION

LO15.1 Explain the terms *supply chain* and *logistics*.

Supply chain A sequence of organizations—their facilities, functions, and activities—that are involved in producing and delivering a product or service

Supply chain management The strategic coordination of the supply chain for the purpose of *integrating* supply and demand management.

Logistics The movement of goods, services, cash, and information in a supply chain.

A **supply chain** is the sequence of organizations—their facilities, functions, and activities—that are involved in producing and delivering a product or service. The sequence begins with basic suppliers of raw materials and extends all the way to their final customers. Facilities include warehouses, factories, processing centers, distribution centers, retail outlets, and offices. Functions and activities include forecasting, purchasing, inventory management, information management, quality assurance, scheduling, production, distribution, delivery, and customer service.

Supply chain management is the strategic coordination of business functions within a business organization and throughout its supply chain for the purpose of *integrating* supply and demand management. Supply chain managers are people at various levels of the organization who are responsible for managing supply and demand both within and across business organizations. They are involved with planning and coordinating activities that include sourcing and procurement of materials and services, transformation activities, and logistics. The main actions are plan, source, make, and deliver. Note that for many services, make and deliver happen at the same time.

Logistics is the part of a supply chain involved with the forward and reverse flow of goods, services, cash, and information. Logistics management includes management of inbound and outbound transportation, material handling, warehousing, inventory, order fulfillment and distribution, third-party logistics, and reverse logistics (the return of goods from customers).

Every business organization is part of at least one supply chain, and many are part of multiple supply chains. Often, the number and type of organizations in a supply chain are determined by whether the supply chain is manufacturing or service oriented. Figure 15.1 illustrates several perspectives of supply chains. Figure 15.2 shows a more detailed version of the farm-to-market supply chain that was shown in Chapter 1, with key suppliers at each stage included.

Supply chains are sometimes referred to as *value chains*, a term that reflects the concept that value is added as goods and services progress through the chain. Supply or value chains typically comprise separate business organizations, rather than just a single organization. Moreover, the supply or value chain has two components for each organization—a supply component and a demand component. The supply component starts at the beginning of the chain and ends with the internal operations of the organization. The demand component of the chain starts at the point where the organization's output is delivered to its immediate customer and ends with the final customer in the chain. The *demand chain* is the sales and distribution portion of the value chain. The length of each component depends on where a particular organization is in the chain; the closer the organization is to the final customer, the shorter its demand component and the longer its supply component.

Supply chains are the lifeblood of any business organization. They connect suppliers, producers, and final customers in a network that is essential to the creation and delivery of goods and services. Managing the supply chain is the process of planning, implementing, and controlling supply chain operations. The basic components are strategy, procurement, supply management, demand management, and logistics. The goal of supply chain management is to match supply to demand as effectively and efficiently as possible. Key aspects relate to:

- Determining the appropriate level of outsourcing
- Managing procurement
- Managing suppliers
- Managing customer relationships
- Being able to quickly identify problems and respond to them

LO15.2 Name the key aspects of supply chain management.

An important aspect of supply chain management is *flow management*. The three types of flow that need to be managed are product and service flow, information flow, and financial flow. Product and service flow involves the movement of goods or services from suppliers to customers, as well as handling customer service needs and product returns. Information flow involves sharing forecast and sales data, transmitting orders, tracking shipments, and updating order status. Financial flow involves credit terms, payments, and consignment and title

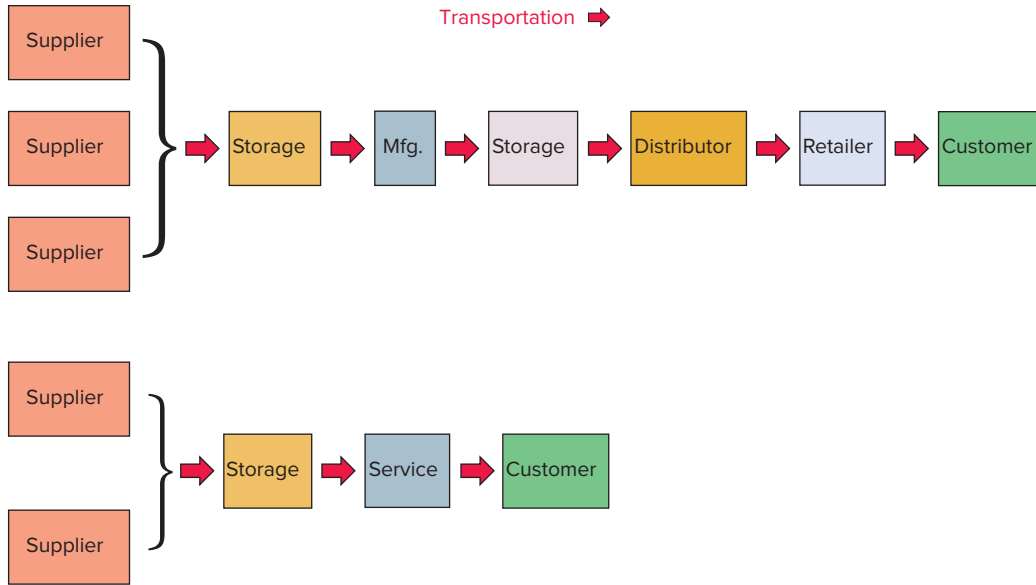
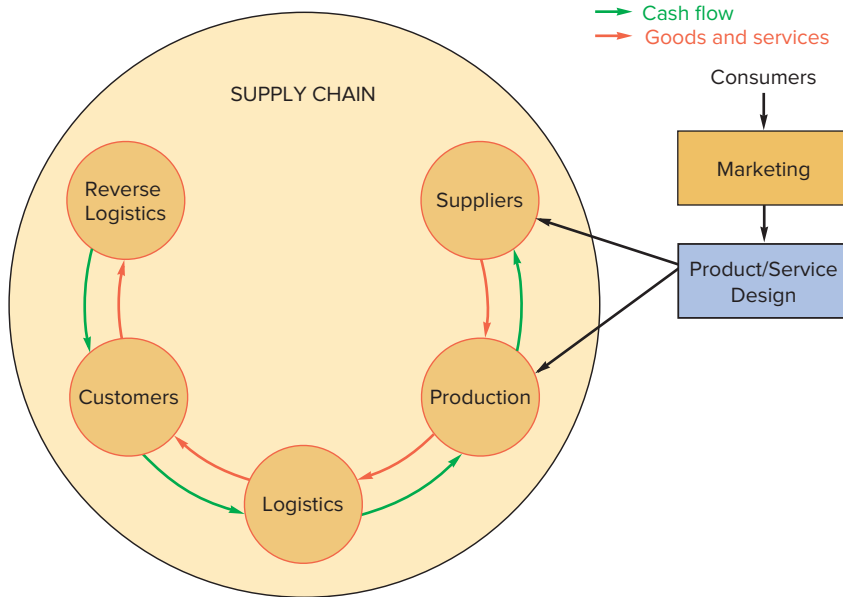

FIGURE 15.1
Typical supply chains

a. A typical manufacturing supply chain.

b. A typical service supply chain.



c. Goods and services flow clockwise in this diagram, and cash flows counterclockwise. Information flows in both directions.

d. A supply chain (network) is analogous to a tree with branches that have side branches.

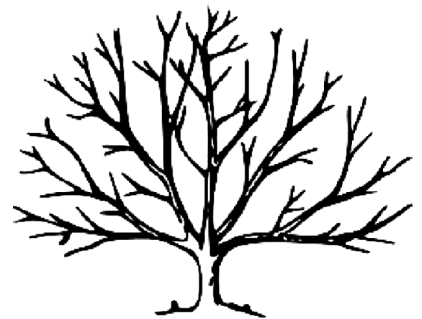

ownership arrangements. Technological advances have greatly enhanced the ability to effectively manage these flows. A dramatic decrease in the cost of transmitting and receiving information and the increased ease and speed of communication have facilitated the ability to coordinate supply chain activities and make timely decisions. In effect, a supply chain is a complex supply network.

15.2 TRENDS IN SUPPLY CHAIN MANAGEMENT

Although different industries and different businesses vary widely in terms of where they are in the evolution of their supply chain management, many businesses emphasize the following:

- Measuring supply chain ROI
- “Greening” the supply chain
- Reevaluating outsourcing

LO15.3 List and briefly explain current trends in supply change management.

FIGURE 15.2

A farm-to-market supply chain

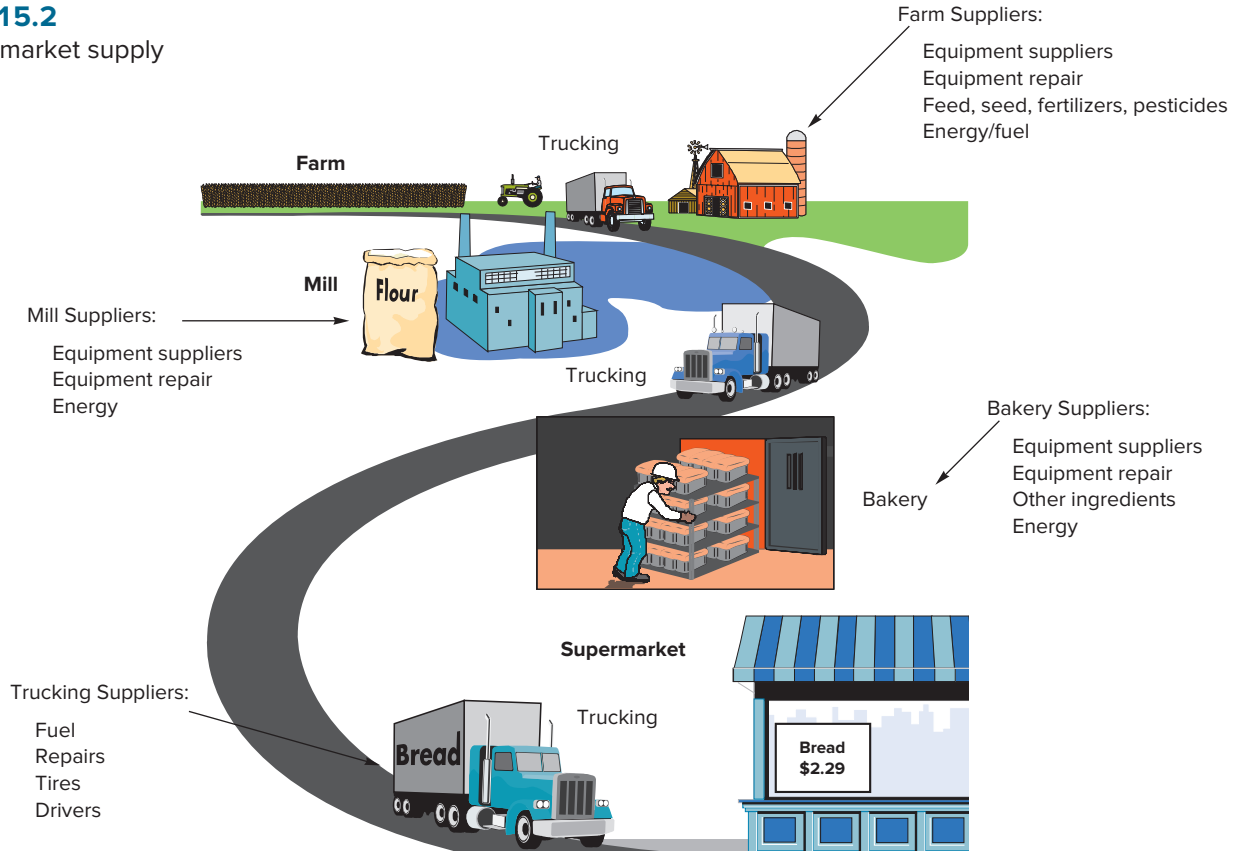

- Integrating IT
- Managing risks
- Adopting lean principles
- Being agile
- Adopting blockchain technology
- Establishing transparency
- Adopting new delivery modes

Measuring supply chain ROI. enables managers to incorporate economics into outsourcing and other decisions, giving them a rational basis for managing their supply chains.

“Greening” the supply chain. is generating interest for a variety of reasons, including corporate responsibility, regulations, and public pressure. This may involve redesigning products and services; reducing packaging; near-sourcing to reduce pollution from transportation (one estimate is that marine shipping alone causes about 60,000 premature deaths annually worldwide due to lung cancer and cardiopulmonary disease);¹ choosing “green” suppliers; managing returns; and implementing end-of-life programs, particularly for appliances and electronic equipment.

Reevaluating outsourcing. Companies are taking a second look at outsourcing, especially global suppliers. Business organizations outsource for a variety of reasons. Often, decisions to outsource have been based on lower prices resulting from lower labor costs. Other potential benefits include the ability to focus on core strengths, converting fixed costs to variable costs, freeing up capital to devote to other needs, shifting some risks to suppliers, taking advantage of supplier expertise, and ease of expansion outside the home country. Some potential difficulties, depending on the nature of what is outsourced and the length of the supply chain, include inflexibility due

LO15.4 Outline the benefits and risks related to outsourcing.

¹James J. Corbett, James J. Winebrake, Erin H. Green, Prasad Kasibhatla, Veronika Eyring, and Axel Lauer, “Mortality from Ship Emissions: A Global Assessment,” *Environmental Science & Technology* 41, no. 24 (December 15, 2007), pp. 8512–18.



Divyakant Solanki/EPA/Shutterstock

Supply chain disruptions can reduce revenue and threaten production and distribution. A risk from accidents is shown here with containers falling from the deck of a damaged cargo ship off the Mumbai coast after a collision between two cargo ships

to longer lead times for delivery of goods with distant suppliers, increased transportation costs, language and cultural differences, loss of jobs, loss of control, lower productivity, loss of ability to do the work internally and loss of business knowledge, knowledge transfer, concerns about intellectual property security, and increased effort needed to manage the supply chain.

One example of where this is getting increased attention is the clothing industry. Rising wages in China and other countries where suppliers make most of the clothing for retail sales provide less of a cost benefit than previously, and long lead times eliminate agility in an industry where the market rewards it. Add in instances of late deliveries and substandard quality, and events like factory fires and building collapses, and the decision to change suppliers and sometimes to back-shore becomes more feasible.

Integrating IT. produces real-time data that can enhance strategic planning and help businesses to control costs, measure quality and productivity, respond quickly to problems, and improve supply chain operations. This is why ERP systems are so important for supply chain management.

Managing risks. For some businesses, the supply chain is a major source of risk, so it is essential to adopt procedures for managing risks. According to a Deloitte survey,² 45 percent of supply chain leaders lack confidence in their risk management. The following section discusses sources of risk and actions businesses can take to reduce risks.

Adopting lean principles. Many businesses are turning to lean principles to improve the performance of their supply chains. In too many instances, traditional supply chains are a collection of loosely connected steps, and business processes are not linked to suppliers' or customers' needs. Applying lean principles to supply chains can overcome this weakness by eliminating non-value-added processes; improving product flow by using pull systems rather than push systems; using fewer suppliers and supplier certification programs, which can nearly eliminate the need for inspection of incoming goods; and adopting the lean attitude of never ceasing to improve the system.

Being agile. Being agile means that a supply chain is flexible enough to be able to respond fairly quickly to unpredictable changes or circumstances, such as supplier production or quality issues, weather disruptions, changing demand (volume of demand or customer preferences), transporting issues, and political issues.

Adopting blockchain technology. Blockchains are shared ledgers where all transactions are recorded securely in real-time and are incapable of being altered or deleted. A blockchain can connect ledgers across an organization's supply chain (suppliers, shippers, producers,

²Deloitte Survey: "Executives Face Growing Threats to Their Supply Chains." New York: Press release, February 7, 2013.



BY LISA SPENCER

With 11,300 stores under 58 company names in 27 countries around the world, Walmart is a logistical and operational giant. It boasts an e-commerce presence in ten countries as well. Its 2.2 million employees oversee the transfer and sale of an average yearly inventory worth \$32 billion. As the world's largest retailer, it generates the highest sales per square foot and operating profit in the discount retail world. For a company whose motto is to help consumers "Save money, live better," an efficient supply chain is essential.

Successful supply chain management means focusing on "right": having the right item to the right customer at the right time, and doing those things efficiently.

Even in its earliest days, founder Sam Walton worked to remove portions of the supply chains, making them shorter, more efficient, and less costly. In Walmart's early days, Walton bought merchandise in bulk and moved it directly to his stores. Two decades later, Walmart partnered with manufacturers to reduce costs and better manage the supply chain. Its vendor-managed inventory initiative put manufacturers in charge of managing their merchandise in Walmart's warehouses, resulting in nearly 100% order fulfillment, and greatly reducing distribution costs.

Other tactics have also contributed to Walmart's supply chain success:

- Strategic, long-term, high-volume partnerships with vendors result in lower prices for customers.
- Cross-docking reduces inventory and transportation costs as well as transit times. Merchandise arriving at distribution centers is unloaded from incoming trucks or railcars and placed onto outbound transport modes, usually in 24 hours or less.
- Distribution centers are on average only 130 miles from stores, further minimizing transportation distances and costs.
- A \$10.5 billion investment in advanced inventory technology helps store employees track inventory and make sure shelves are fully stocked. Walmart uses its massive information technology infrastructure, the biggest of any privately held company in the world, to forecast demand and inventory levels, develop efficient delivery routing, and interface with customers. The constant flow of information about demand patterns and customer purchases allows product to be pulled through the system via demand, rather than being pushed into the stores whether needed or not.
- The Top Stock program, begun in 2017, moves extra inventory out of back rooms and onto the top shelves in stores, making it easy for associates to find, and shortening the distance they have to travel to get it when it is needed. That also keeps associates out on the floor more, instead of being out of sight

hunting for merchandise in back rooms. More back room space can now be used to fulfill online orders or to host other functions, like job training and team building.

- Walmart joined an alliance of food industry businesses adopting an IBM blockchain to improve supply chain safety and sustainability. Lettuce and spinach suppliers provide precise information about their produce in the blockchain database. In the event of a crisis, such as the romaine lettuce *e-coli* outbreak of 2018, Walmart could quickly trace and contain contaminated produce. Whereas in the past it might take a week to identify and isolate contaminated items, the blockchain system can do the job in about two seconds.
- Seeking an edge over rival Amazon, Walmart tightened expectations for on-time, in full (OTIF) deliveries. Truckers must now deliver within a two-day window 87% of the time, as compared to 85% previously. Suppliers face fines if they miss the targets. Fines are levied not only for late shipments, but for shipments that do not contain all of the ordered merchandise. Delivery accuracy is becoming increasingly critical as Walmart offers more in-store pickup and other omnichannel delivery options and seeks to compete with strong market players like Amazon. The OTIF program has resulted in more shipments arriving on time and in full, keeping shelves better stocked with less inventory storage required in back rooms.

With omnichannel systems becoming the norm and technological capabilities becoming increasingly complex, Walmart continues to position itself to be a supply chain leader of the future.

Questions

1. What improvements has Walmart made to its supply chain system?
2. What competitive advantages might Walmart have over Amazon?

Based on: Dan Berthiaume, "Report: Walmart seeks supply chain edge over Amazon," Chain Store Age, March 8, 2019, <https://www.chainstoreage.com/operations/report-walmart-seeks-supply-chain-edge-over-amazon/>
"Company Facts," visited March 23, 2019, <https://corporate.walmart.com/newsroom/company-facts>

Matt Leanoard, "Walmart tightens on-time, in-full rate for suppliers to 87%," Supply Chain Dive, March 8, 2019, <https://www.supplychaindive.com/news/walmart-on-time-in-full-87-suppliers/550083/>

Kim Souza, "The Supply Side: Retail supply chain digitization lags," Talk Business and Politics, March 17, 2019, <https://talkbusiness.net/2019/03/the-supply-side-retail-supply-chain-digitization-lags/>

Elizabeth Sturcken, "Supply Chain Disruptions Keeping You Up At Night? These Technologies Can Help," Forbes, March 19, 2019, <https://www.forbes.com/sites/edfenergyexchange/2019/03/19/supply-chain-disruptions-keeping-you-up-at-night-these-technologies-can-help/#37e52d586371>

"Walmart's successful supply chain management," Tradegecko, visited March 23, 2019, <https://www.tradegecko.com/blog/incredibly-successful-supply-chain-management-walmart>

distributors, retailers, and final consumer) to improve the accuracy and efficiency of tracking products, eliminating a manual process that can take days into an automated process that takes seconds.

Advances from AI to blockchains are fostering intelligent supply chains, autonomous systems that can streamline supply chain processes. Blockchains will provide greater transparency



BY LISA SPENCER

Supply chain transparency can be a big competitive advantage over rivals who aren't transparent when it comes to where and how their products are produced. This is particularly true in the retail industry, where consumers are increasingly concerned with the "where and how" of the products they purchase are produced.

Technology is a big part of this. Electronic tracking (RFID) of goods from raw materials through production and distribution allows for much more information than paper or cloth labels. Furthermore, some companies provide consumers with portals that enable them to view production operations. Some of Walmart's suppliers have responded to the public's call for greater transparency in labor practices by installing webcams in their factories that consumers can access to get a firsthand look at operations in clothing factories.

Some manufacturers even make facility inspection results and product safety sheets available publicly and provide customers with information about every step in the supply chain. Not only does this increase customer satisfaction, it also bolsters any ethical claims companies make.

Questions

1. How concerned should customers be about what occurs in the supply chains for clothing they purchase?
2. What are the benefits and costs for companies involved in increasing supply chain transparency?

Based on: "Why Supply Chain Transparency Results in Big Business Benefits" by Megan Ray Nichols. <https://cerasis.com/supply-chain-transparency>

and trust among supply chain partners. Intelligent supply chains provide real-time visibility across the supply chain and manufacturing operations, facilitating collaboration and improving forecasts to better manage inventories and make matching supply and demand more efficient and less costly.

Blockchains also enable companies to build anti-counterfeit databases, track stolen products, or track items with specific qualities, such as luxury products that rely on product authenticity. One promising application of blockchain is contract and document management by digitalizing them and moving the management of paper certificates, warranties, and contracts into a blockchain that can automatically update the documents as needed. Another application is in the food safety industry, where blockchains will soon allow food items to be tracked, so when a producer identifies a problem, such as a tainted batch of romaine lettuce, the problem can be contained by identifying the source and issuing a recall for only the affected products.

Establishing transparency. Buyers, especially consumers, are becoming increasingly interested in knowing where and how the goods they purchase are made.

Adopting new delivery modes. Adding to traditional shipping modes that include trucks, trains, boats, mail, and companies such as FedEx and UPS, self-driving vehicles and drones are now increasingly being used to deliver to individual customers. Robots deliver pizza and other fast-food items on some college campuses. Grubhub and Doordash deliver restaurant meals, and other services shop for and deliver groceries. This provides more options for shippers, but also more challenges. Risks and liability issues are among the challenges.

As a result of these current and possible future trends, organizations are likely to give serious thought to reconfiguring their supply chains to reduce risks, improve flow, reduce costs and increase profits, and generally increase customer satisfaction.

Risk Management and Resiliency

Risk management involves identifying risks, assessing their likelihood of occurring and their potential impact, and then developing strategies for addressing those risks. Strategies can pertain to *risk avoidance*, *risk reduction*, and *risk sharing* with supply chain partners. *Risk avoidance* may mean not dealing with suppliers in a certain area, *risk reduction* can mean replacing unreliable suppliers, and *risk sharing* can mean contractual arrangements with supply chain partners that spread the risk. **Resiliency** is the ability of a business to recover from an event that negatively impacts the supply chain. Recovery is a function of the severity of the impact and the plans that are in place to cope with the event. Businesses can reduce, but not eliminate, the need for resiliency by managing risks.

LO15.5 Explain what the main supply chain risks are and what businesses can do to minimize those risks.

Resiliency The ability of a business to recover from an event that negatively impacts the supply chain.



One of 3M's many products is a plastic hook. Production occurred at several widely scattered locations in the Midwest. The process started in a Springfield, Missouri, plant that made adhesives, which were then shipped about 550 miles to a plant in Hartford City, Indiana, where the adhesive was applied to foam. Next, the foam was shipped another 600 miles to a plant near Minneapolis, Minnesota, where the foam was cut into individual pieces and imprinted with the 3M logo. Finally, the foam pieces were shipped to a plant in central Wisconsin, another 200 miles or so, where they were bundled with the hooks and packages for sale. This entire process took over a hundred days and over 1,000 miles to complete.

3M eventually consolidated operations in a single plant in Hutchinson, Minnesota, where a number of other 3M products are made. That eliminated all the travel and reduced the process time by two-thirds.

Situations like this can arise when businesses acquire other companies and then elect to maintain their processing operations in their current locations.

Questions

1. Businesses sometimes acquire widely dispersed processing facilities through a number of mergers or acquisitions. What trade-offs might they face in considering consolidation?
2. This reading offers one possible reason for the existence of a long supply process. Can you think of some other possible reasons for long supply processes?

Based on: "3M Begins Untangling Their Hairballs." *The Wall Street Journal*, May 17, 2012.

The first step in risk management is to identify potential risks. Supply chain risks fall into several categories. One is disruptions, which can come from natural disasters—such as fires, flooding, hurricanes, and the like—that either disrupt shipping or that affect suppliers directly (by damaging production or storage facilities) or indirectly (by impacting access to facilities or impacting employees in other ways). Other disruptions can occur as a result of supplier issues such as labor strife, production problems, and supplier bankruptcy. Another source of risk is quality issues, which can disrupt supplies and may lead to product recalls, liability claims, and negative publicity. Still another risk is the potential for suppliers divulging sensitive information to competitors that weakens a competitive advantage.

Key elements of successful risk management include:

Knowing your suppliers. Mapping the supply chain can be helpful in grasping the scope of the supply chain, identifying suppliers, and seeing if there are any supplier concentrations in first or second tiers of suppliers, which can greatly amplify risk. This might also lead to the desirability of simplifying (shortening) the supply chain.

Providing supply chain visibility. **Supply chain visibility** means that a major trading partner can connect to any part of its supply chain to access data in real time on inventory levels, shipment status, and similar key information. This requires data sharing.

Developing event-response capability. **Event-response capability** is the ability to detect and respond to unplanned events such as delayed shipment or a warehouse running low on a certain item. An event management system should have four capabilities: monitoring the system; notifying when certain planned or unplanned events occur; simulating potential solutions when an unplanned event occurs; and measuring the long-term performance of suppliers, transporters, and other supply chain partners.

Event response can mean identifying alternate sources of supply. General operations should also include the ability to deal with unknown disruptions—that is, events that cannot generally be predicted, but which can, if they occur, have an impact on the supply chain. Because these are unknowns, the severity and length of such disruptions are impossible to predict. Consequently, it is important to recognize that unforeseen events could happen, and to have a plan for addressing them should they occur.

Shortening the Supply Chain

As businesses search for ways to reduce transportation time and cost, some are placing more emphasis on using nearby suppliers, storage facilities, and processing centers. Others are finding savings by consolidating their supply chains, as described in the Reading Box.

Supply chain visibility A major trading partner can connect to its supply chain to access data in real time.

Event-response capability The ability to detect and respond to unplanned events.

15.3 GLOBAL SUPPLY CHAINS

As businesses increasingly make use of outsourcing and pursue opportunities beyond their domestic markets, their supply chains are becoming increasingly global. For example, product designs often use inputs from around the world, especially when products are sold globally.

As businesses recognize the strategic importance of effective supply chain management, they are also discovering that global supply chains have additional complexities that were either negligible or nonexistent in domestic operations. These complexities include language and cultural differences, currency fluctuations and tariffs, time differences in terms of discussions and travel, armed conflicts, increased transportation costs and lead times, and the increased need for trust and cooperation among supply chain partners. Furthermore, managers must be able to identify and analyze factors that differ from country to country, which can affect the success of the supply chain, including local capabilities; financial, transportation, and communication infrastructures; governmental, environmental, and regulatory issues; and political issues.

These and other factors have made risk management an important aspect of global supply chain management. To compensate for this, some firms have increased the amount of inventory at various points in their supply chains, thereby losing some of the benefits of global sourcing.

Risks can relate to supply (e.g., weather conditions, supplier failure, quality issues, sustainability issues, transportation issues, pirates, and terrorism), costs (e.g., increasing commodity costs), and demand (e.g., decreasing demand, demand volatility, and transportation issues). Still other risks can involve intellectual rights issues, contract compliance issues, competitive pressure, forecasting errors, and inventory management.

A positive factor of globalization has been the set of technological advances in communications: the ability to link operations around the world with real-time information exchange. Consequently, information technology has a key role in integrating operations across global supply chains. Unfortunately, there are some parts of the globe that are still not connected.

LO15.6 Describe some of the complexities related to global supply chains.

15.4 ERP AND SUPPLY CHAIN MANAGEMENT

Supply chain management that integrates ERP is a formal approach to effectively plan and manage all the resources of a business enterprise. Implementation of ERP involves establishing operating systems and operating performance measurements to enable them to manage business operations and meet business and financial objectives. ERP encompasses supply chain management activities such as planning for demand and managing supply, inventory replenishment, production, warehousing, and transportation. ERP software also plays a key role in centralizing transaction data.

ERP software can provide the ability to coordinate, monitor, and manage a supply chain. It is an integrated system that provides for systemwide visibility of key activities and events in areas such as supplier relationships, performance management, sales and order fulfillment, and customer relationships.

Supplier Relationship Management ERP integrates purchasing, receiving, information about vendor ratings and performance, lead times, quality, electronic funds disbursements, simplifying processes, and enabling analysis of those processes.

Performance Management This aspect of ERP pulls together information on costs and profits, productivity, quality performance, and customer satisfaction.

Sales and Order Fulfillment ERP includes the ability to provide inventory and quality management, track returns, and schedule and monitor production, packaging, and distribution. Reports can provide information on order and inventory status, delivery dates, and logistics performance.

Customer Relationship Management An ERP system not only centralizes basic contact information, details on contracts, payment terms, credit history, and shipping preferences, it also provides information on purchasing patterns, service, and returns.

15.5 ETHICS AND THE SUPPLY CHAIN

LO15.7 Briefly describe ethical issues in supply chains and the key steps companies can take to avoid ethical problems.

There are many examples of unethical behavior involving supply chains. They include bribing government or company officials to secure permits or favorable status; “exporting smokestacks” to developing countries; claiming a “green” supply chain when in reality the level of “green” is only minimal; ignoring health, safety, and environmental standards; violating basic rights of workers (e.g., paying substandard wages; using sweatshops, forced labor, or child labor); mislabeling country of origin; and selling goods abroad that are banned at home.

Every company should develop an ethical supply chain code to guide behavior. A code should cover behaviors that involve customers, suppliers, suppliers’ behaviors, contract negotiation, recruiting, and the environmental issues.

A major risk of unethical behavior is that when such behavior is exposed in the media, consumers tend to blame the major company or brand in the supply chain associated with the ethical infractions that were actually committed by legally independent companies in the supply chain. The problem is particularly difficult to manage when supply chains are global, as they often are in manufacturing operations. Unfortunately, many companies lack the ability to quickly contact most or all of the companies in their supply chain, and communicate with suppliers on critical issues of ethics and compliance. Although monitoring of supply chain activities is essential, it is only one aspect of maintaining an ethical supply chain. With global manufacturing and distribution, supply chain scrutiny should include all supply chain activities from purchasing, manufacturing, assembly, and transportation, to service and repair operations, and eventually to the proper disposal of products at the end of their useful life.

Key steps companies can take to reduce the risk of damages due to unethical supplier behavior are to choose those that have a reputation for good ethical behavior; incorporate compliance with labor standards in supplier contracts; develop direct, long-term relationships with ethical suppliers; and address quickly any problems that occur.

An ethical and sustainable global supply chain has fair wages, good working conditions, gender equality, and does nothing to harm workers or the environment.

15.6 SMALL BUSINESSES

LO15.8 Describe the three concerns of small businesses related to the supply chain and suggest ways to manage those concerns.

Small businesses do not always give adequate attention to their supply chains. However, there are many benefits to be had for small businesses by actively managing their supply chains, including increased efficiencies, reduced costs, reduced risks, and increased profits. And size can actually be a competitive advantage for small businesses because they frequently are more agile than larger companies, enabling them to make decisions and changes more quickly when the need arises.

Three aspects of supply chain management that are often of concern to small businesses are:

- Inventory management
- Reducing risks
- International trade

Inventories can be an issue for small businesses. They may carry extra inventory as a way to avoid shortages due to supply chain interruptions. However, that can tie up capital and take up space. An alternative is to have backup suppliers for critical items. Similarly, having backups for delivery from suppliers and deliveries to customers can help overcome disruptions.

Because it can take a fair amount of time to set up accounts, it is prudent to have these systems in place before they are needed to maintain operations.

Another area that often needs attention is risk management. The key to reducing risks is managing suppliers. Important steps are:

- Use only reliable suppliers
- Determine which suppliers are critical; get to know them, and any challenges they have
- Measure supplier performance (e.g., quality, reliability, flexibility)
- Recognize warning signs of supplier issues (e.g., late deliveries, incomplete orders, quality problems)
- Have plans in place to manage supply chain problems

Exporting can offer opportunities for small business producers to greatly expand their businesses, although they typically lack the knowledge to do so, which can cause unforeseen problems. For instance, exporting nonconforming goods or packaging can result in shipments being held up at a port of entry, which can be costly and time-consuming, and can lead to dissatisfied customers.

Importing can have benefits for small businesses. The Small Business Administration has some tips for using foreign suppliers:³

- Work with someone who has expertise to help oversee foreign suppliers, preferably someone who spends a good deal of time in that country. Also, a licensed customs broker can help with laws and regulations, necessary documents, and working with importers and exporters.
- Describe your buying patterns and schedules to set expectations for demand and timing.
- Don't rely on a single supplier; a backup supplier can reduce risk and provide bargaining leverage.
- Building goodwill can have benefits in negotiations and resolving problems when they arise.
- Consider using domestic suppliers if the risks or other issues with foreign suppliers are formidable. Advantages can involve lower shipping times and costs, closer interactions with suppliers, and increased agility.

15.7 MANAGEMENT RESPONSIBILITIES

Generally speaking, corporate management responsibilities have legal, economic, and ethical aspects. Legal responsibilities include being knowledgeable about laws and regulations of the countries where supply chains exist, obeying the laws, and operating to conform to regulations. Economic responsibilities include supplying products and services to meet demand as efficiently as possible. Ethical responsibilities include conducting business in ways that are consistent with the moral standards of society.

SOME SUPPLY CHAIN STRATEGIES

There are many different strategies a business organization can choose from. Here is a sample of some of those strategies:

Responsive/agile. A flexible supply chain that has the ability to quickly respond to changes in product requirements or volume of demand, as well as adapt to supply chain disruptions.

Lean supply chain. Focused on eliminating non-value-added activities to create an efficient, low-cost supply chain.

Near-sourcing. Using nearby suppliers shortens the supply chain, reducing transportation time and cost, reducing supply chain inventory, reducing the risk of disruptions, and increasing responsiveness.

³U.S. Small Business Administration, "5 Tips for Managing an Efficient Global Supply Chain," *Small Business Operations*, March 12, 2013.

More specific areas of responsibility relate to organizational strategy, tactics, and operations.

Strategic Responsibilities

LO15.9 List several strategic, tactical, and operational responsibilities related to managing the supply chain.

Top management has certain strategic responsibilities that have a major impact on the success not only of supply chain management but also of the business itself. These strategies include:

Supply chain strategy alignment: Aligning supply and distribution strategies with organizational strategy and deciding on the degree to which outsourcing will be employed.

Network configuration: Determining the number and location of suppliers, warehouses, production/operations facilities, and distribution centers.

Information technology: Integrating systems and processes throughout the supply chain to share information, including forecasts, inventory status, tracking of shipments, and events. This is often more difficult to achieve with small suppliers than with large suppliers.

Products and services: Making decisions on new product and services selection and design.

Capacity planning: Assessing long-term capacity needs, including when and how much will be needed and the degree of flexibility to incorporate.

Strategic partnerships: Partnership choices, level of partnering, and degree of formality.

Distribution strategy: Deciding whether to use centralized or decentralized distribution, and deciding whether to use the organization's own facilities and equipment for distribution or to use third-party logistics providers.

Uncertainty and risk reduction: Identifying potential sources of risk and deciding the amount of risk that is acceptable.

Key Tactical and Operational Responsibilities

The key tactical and operational responsibilities are outlined in Table 15.1.

TABLE 15.1

Key tactical and operational responsibilities

Tactical Responsibilities

Forecasting: Prepare and evaluate forecasts.

Sourcing: Choose suppliers and some make-or-buy decisions.

Operations planning: Coordinate the external supply chain and internal operations.

Managing inventory: Jointly decide with suppliers where in the supply chain to store the various types of inventory (raw materials, semi-finished goods, finished goods).

Transportation planning: Match capacity with demand.

Collaborating: Work with supply chain partners to coordinate plans.

Operational Responsibilities

Scheduling: Short-term scheduling of operations and distribution.

Receiving: Management of inbound deliveries from suppliers.

Transforming: Conversion of inputs into outputs.

Order fulfilling: Linking production resources and/or inventory to specific customer orders.

Managing inventory: Maintenance and replenishment activities.

Shipping: Management of outbound deliveries to distribution centers and/or customers.

Information sharing: Exchange of information with supply chain partners.

Controlling: Control of quality, inventory, and other key variables and implementing corrective action, including variation reduction, when necessary.

15.8 PROCUREMENT

The purchasing department of an organization is responsible for obtaining the materials, parts, supplies, and services needed to produce a product or provide a service. You can get some idea of the importance of purchasing when you consider that, in manufacturing, upwards of 60 percent of the cost of finished goods comes from purchased parts and materials. Furthermore, the percentages for purchased inventories are even higher for retail and wholesale companies, sometimes exceeding 90 percent. Nonetheless, the importance of purchasing is more than just the cost of goods purchased; other important factors include the *quality* of goods and services and the *timing* of deliveries of goods or services, both of which can have a significant impact on operations.

Among the duties of purchasing are identifying sources of supply, negotiating contracts, maintaining a database of suppliers, obtaining goods and services that meet or exceed operations requirements in a timely and cost-efficient manner, and managing suppliers.

Purchasing Interfaces

Purchasing has interfaces with a number of other functional areas, as well as with outside suppliers. It is the connecting link between the organization and its suppliers. In this capacity, it exchanges information with suppliers and functional areas. The interactions between purchasing and these other areas are briefly summarized in the following paragraphs.

Operations constitute the main source of requests for purchased materials, and close cooperation between these units and the purchasing department is vital if quality, quantity, and delivery goals are to be met. Cancellations, changes in specifications, or changes in quantity or delivery times must be communicated immediately for purchasing to be effective.

The purchasing department may require the assistance of the *legal* department in contract negotiations, in drawing up bid specifications for nonroutine purchases, and in helping interpret legislation on pricing, product liability, and contracts with suppliers.

Accounting is responsible for handling payments to suppliers and must be notified promptly when goods are received in order to take advantage of possible discounts. In many firms, *data processing* is handled by the accounting department, which keeps inventory records, checks invoices, and monitors vendor performance.

Design and engineering usually prepare material specifications, which must be communicated to purchasing. Because of its contacts with suppliers, purchasing is often in a position to pass information about new products and materials improvements on to design personnel. Also, design and purchasing people may work closely to determine whether changes in specifications, design, or materials can reduce the cost of purchased items (see the following section on value analysis).

Receiving checks incoming shipments of purchased items to determine whether quality, quantity, and timing objectives have been met, and it moves the goods to temporary storage. Purchasing must be notified when shipments are late; accounting must be notified when shipments are received so that payments can be made; and both purchasing and accounting must be apprised of current information on continuing vendor evaluation.

Suppliers or vendors work closely with purchasing to learn what materials will be purchased and what kinds of specifications will be required in terms of quality, quantity, and deliveries. Sometimes this involves new suppliers instead of existing suppliers. Purchasing must rate vendors on cost, reliability, and so on (see the later section on vendor analysis). Good supplier relations can be important on rush orders and changes, and vendors provide a good source of information on product and material improvements.

Figure 15.3 depicts the purchasing interfaces.

The Purchasing Cycle

The **purchasing cycle** begins with a request from within the organization to purchase material, equipment, supplies, or other items from outside the organization, and the cycle ends

LO15.10 Discuss procurement in terms of the purchasing interfaces, the purchasing cycle, ethics, and centralized versus decentralized decision making.

Purchasing cycle Series of steps that begin with a request for purchase and end with notification of shipment received in satisfactory condition.

FIGURE 15.3
Purchasing interfaces

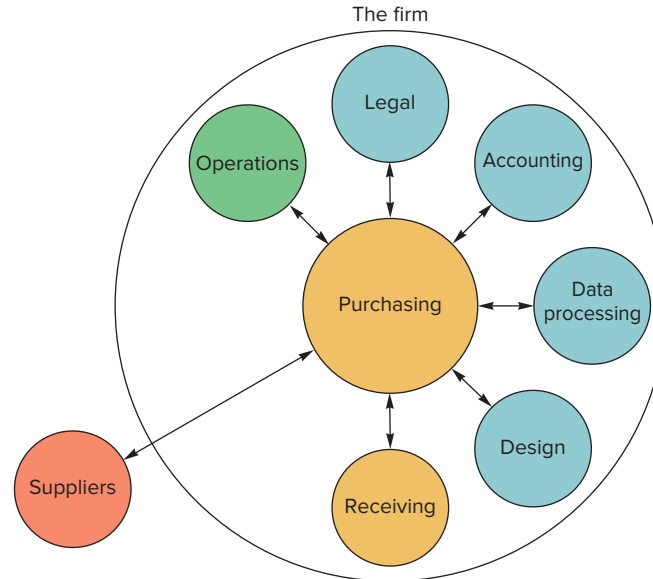

when the purchasing department is notified that a shipment has been received in satisfactory condition. The main steps in the cycle are these:

1. **Purchasing receives the requisition.** The requisition includes (a) a description of the item or material desired, (b) the quantity and quality necessary, (c) desired delivery dates, and (d) who is requesting the purchase.
2. **Purchasing selects a supplier.** The purchasing department must identify suppliers who have the capability of supplying the desired goods. If no suppliers are currently listed in the files, new ones must be sought. Vendor ratings may be referred to in choosing among vendors, or perhaps rating information can be relayed to the vendor with the thought of upgrading future performance.
3. **Purchasing places the order with a vendor.** If the order involves a large expenditure, particularly for a one-time purchase of equipment, for example, vendors will usually be asked to bid on the job, and operating and design personnel may be asked to assist in negotiations with a vendor. Large-volume, continuous-usage items may be covered by blanket purchase orders, which often involve annual negotiation of prices with deliveries subject to request throughout the year. Moderate-volume items may also have blanket purchase orders, or they may be handled on an individual basis. Small purchases may be handled directly between the operating unit requesting a purchased item and the supplier, although some control should be exercised over those purchases so they don't get out of hand.
4. **Monitoring orders.** Routine follow-up on orders, especially large orders or those with lengthy lead times, allows the purchasing department to project potential delays and relay that information to the operating units. Conversely, the purchasing department must communicate changes in quantities and delivery needs of the operating units to suppliers to allow them time to change their plans.
5. **Receiving orders.** Receiving must check incoming shipments for quality and quantity. It must notify purchasing, accounting, and the operating unit that requested the goods. If the goods are not satisfactory, they may have to be returned to the supplier or subjected to further inspection.

Centralized versus Decentralized Purchasing

Purchasing can be centralized or decentralized. Centralized purchasing means that purchasing is handled by one special department. Decentralized purchasing means that individual departments or separate locations handle their own purchasing requirements.

Centralized purchasing may be able to obtain lower prices than decentralized units if the higher volume created by combining orders enables it to take advantage of quantity discounts offered on large orders. Centralized purchasing may also be able to obtain better service and closer attention from suppliers. In addition, centralized purchasing often enables companies to assign certain categories of items to specialists, who tend to be more efficient because they are able to concentrate their efforts on relatively few items instead of spreading themselves across many items.

Decentralized purchasing has the advantage of awareness of differing “local” needs and being better able to respond to those needs. Decentralized purchasing usually can offer quicker response than centralized purchasing. Where locations are widely scattered, decentralized purchasing may be able to save on transportation costs by buying locally, which has the added attraction of creating goodwill in the community.

Some organizations manage to take advantage of both centralization and decentralization by permitting individual units to handle certain items while centralizing purchases of other items. For example, small orders and rush orders may be handled locally or by departments, while centralized purchases would be used for high-volume, high-value items for which discounts are applicable or specialists can provide better service than local buyers or departments.

Ethics in Purchasing

Ethical behavior is important in all aspects of business. This is certainly true in purchasing, where the temptations for unethical behavior can be enormous. Buyers often hold great power, and salespeople are often eager to make a sale. Unless both parties act in an ethical manner, the potential for abuse is very real. Furthermore, with increased globalization, the challenges are particularly great because a behavior regarded as customary in one country might be regarded as unethical in another country.

The National Association of Purchasing Management has established a set of guidelines for ethical behavior. (See Table 15.2.) This list offers some insight into the scope of ethics issues in purchasing.

Centralized purchasing Purchasing is handled by one special department.

Decentralized purchasing Individual departments or separate locations handle their own purchasing requirements.

PRINCIPLES
Integrity in Your Decisions and Actions
Value for Your Employer
Loyalty to Your Profession

STANDARDS

1. **Perceived Impropriety.** Prevent the intent and appearance of unethical or compromising conduct in relationships, actions, and communications.
2. **Conflicts of Interest.** Ensure that any personal, business, or other activity does not conflict with the lawful interests of your employer.
3. **Issues of Influence.** Avoid behaviors or actions that may negatively influence, or appear to influence, supply management decisions.
4. **Responsibilities to Your Employer.** Uphold fiduciary and other responsibilities using reasonable care and granted authority to deliver value to your employer.
5. **Supplier and Customer Relationships.** Promote positive supplier and customer relationships.
6. **Sustainability and Social Responsibility.** Champion social responsibility and sustainability practices in supply management.
7. **Confidential and Proprietary Information.** Protect confidential and proprietary information.
8. **Reciprocity.** Avoid improper reciprocal agreements.
9. **Applicable Laws, Regulations, and Trade Agreements.** Know and obey the letter and spirit of laws, regulations, and trade agreements applicable to supply management.
10. **Professional Competence.** Develop skills, expand knowledge, and conduct business that demonstrates competence and promotes the supply management profession.

TABLE 15.2

Guidelines for ethical behavior in purchasing

15.9 E-BUSINESS

E-business The use of electronic technology to facilitate business transactions.

E-business refers to the use of electronic technology to facilitate business transactions. E-business, or e-commerce, involves the interaction of different business organizations, as well as the interaction of individuals with business organizations. Applications include internet buying and selling, e-mail, order and shipment tracking, and electronic data interchange. In addition, companies use e-business to promote their products or services, and to provide information about them. Delivery firms have seen the demand for their services increase dramatically due to e-business. Among them are giants UPS and FedEx. In addition, some companies such as Amazon and Walmart are handling some of their own deliveries.

Table 15.3 lists some of the numerous advantages of e-business.

There are two essential features of e-business: the website or an app, and order fulfillment. Companies may invest considerable time and effort in front-end design of a website, or employ apps, but the back end (order fulfillment) is at least as important. It involves order processing, billing, inventory management, warehousing, packing, shipping, and delivery.

Many of the problems that occur with internet selling are supply related. The ability to order quickly creates an expectation in customers that the remainder of the process will proceed smoothly and quickly. But the same capability that enables quick ordering also enables demand fluctuations that can inject a certain amount of chaos into the system, almost guaranteeing that there won't be a smooth or quick delivery. Oftentimes, the rate at which orders come in via the internet greatly exceeds an organization's ability to fulfill them, leading to customer dissatisfaction.

In the early days of internet selling, many organizations thought they could avoid bearing the costs of holding inventories by acting solely as intermediaries, having their suppliers ship directly to their customers. Although this approach worked for some companies, it failed for others, usually because suppliers ran out of certain items. This led some companies to rethink the strategy. Industry giants such as Amazon.com and Barnesandnoble.com built huge warehouses around the country so they could maintain greater control over their inventories. And Amazon handles much of this for smaller sellers. Still others are outsourcing fulfillment,

TABLE 15.3

Advantages of e-business

Companies and publishers have a global presence and the customer has global choices and easy access to information.
Companies can improve competitiveness and quality of service by allowing access to their services any place, any time. Companies also have the ability to monitor customers' choices and requests electronically.
Companies can analyze the interest in various products based on the number of hits and requests for information.
Companies can collect detailed information about clients' preferences, which enables mass customization and personalized products. An example is the purchase of PCs over the web, where the buyer specifies the final configuration.
Supply chain response times are shortened. The biggest impact is on products that can be delivered directly on the web, such as forms of publishing and software distribution.
The roles of the intermediary and sometimes the traditional retailer or service provider are reduced or eliminated entirely in a process called <i>disintermediation</i> . This process reduces costs and adds alternative purchasing options.
Substantial cost savings and substantial price reductions related to the reduction of transaction costs can be realized. Companies that provide purchasing and support through the web can save significant personnel costs.
E-commerce allows the creation of virtual companies that distribute only through the web, thus reducing costs. Amazon.com and other net vendors can afford to sell for a lower price because they do not need to maintain retail stores and, in many cases, warehouse space.
The playing field is leveled for small companies that lack significant resources to invest in infrastructure and marketing.

Source: Reprinted by permission from David Simchi-Levi, Philip Kaminsky, and Edith Simchi-Levi, *Designing and Managing the Supply Chain: Concepts, Strategies, and Case Studies* (New York: Irwin/McGraw-Hill, 2000), p. 235.

Type	Description
Financial	Provide financial and other resources for web-enhanced commerce.
Technology	Provide software, applications, and expertise necessary to create B2B marketplace.

Source: Adapted from *Forbes*, July 17, 2000.

turning over that portion of their business to third-party fulfillment operators such as former catalog fulfillment company Fingerhut, now a unit of Federated Department Stores.

Using third-party fulfillment means losing control over fulfillment. It might also result in fulfillers substituting their standards for the company they are serving, and using the fulfiller's shipping price structure. On the other hand, an e-commerce company may not have the resources or infrastructure to do the job itself. Another alternative might be to form a strategic partnership with a bricks-and-mortar company. This can be a quick way to jump-start an e-commerce business. In any case, somewhere in the supply chain there has to be a bricks-and-mortar facility.

A growing portion of e-business involves business-to-business (B2B) commerce. To facilitate business-to-business commerce, B2B marketplaces are created. Table 15.4 describes B2B marketplace enablers.

B2B exchanges can improve supply chain visibility to trading partners from a single point of access, facilitating the development of common standards and data formats for schedules, product codes, location codes, and performance criteria. And e-businesses focusing on transportation services can benefit from having an efficient hub for collaboration between shippers and transportation providers, helping to translate customer shipment forecasts into more predictable demand for equipment, and enabling carriers to deploy their equipment more effectively.

15.10 SUPPLIER MANAGEMENT

Reliable and trustworthy suppliers are a vital link in an effective supply chain. Timely deliveries of goods or services and high quality are just two of the ways suppliers can contribute to effective operations. A purchasing manager may function as an “external operations manager,” working with suppliers to coordinate supplier operations and buyer needs.

In this section, various aspects of supplier management are described, including supplier audits, supplier certification, and supplier partnering. The section starts with an aspect that can have important ramifications for the entire organization: choosing suppliers.

Choosing Suppliers

In many respects, choosing a vendor involves taking into account many of the same factors associated with making a major purchase (e.g., a car or stereo system). A company considers price, quality, the supplier's reputation, past experience with the supplier, and service after the sale. The main difference is that a company, because of the quantities it orders and operations requirements, often provides suppliers with detailed specifications of the materials or parts it wants instead of buying items off the shelf, although most organizations buy standard items that way. The main factors a company takes into account when it selects a vendor are outlined in Table 15.5.

Because different factors are important for different situations, purchasing must decide, with the help of operations, the importance of each factor (i.e., how much weight to give to each factor), and then rate potential vendors according to how well they can be expected to perform against this list. This process is called **vendor analysis**, and it is conducted periodically, or whenever there is a significant change in the weighting assigned to the various factors.

Supplier Audits

Periodic audits of suppliers are a means of keeping current on suppliers' production (or service) capabilities, quality and delivery problems and resolutions, and suppliers' performance on other criteria. If an audit reveals problem areas, a buyer can attempt to find a solution

TABLE 15.4
B2B marketplace enablers

LO15.11 Briefly describe the key aspects of supplier management.

Vendor analysis Evaluating the sources of supply in terms of price, quality, reputation, and service.

TABLE 15.5
Choosing a supplier

Factor	Typical Questions
Quality and quality assurance	What procedures does the supplier have for quality control and quality assurance? Are quality problems and corrective actions documented?
Flexibility	How flexible is the supplier in handling changes in delivery schedules, quantity, and product or service changes?
Location	Is the supplier nearby?
Price	Are prices reasonable given the entire package the supplier will provide? Is the supplier willing to negotiate prices? Is the supplier willing to cooperate to reduce costs?
Product or service changes	How much advance notification does the supplier require for product or service changes?
Reputation and financial stability	What is the reputation of the supplier? How financially stable is the supplier?
Lead times and on-time delivery	What lead times can the supplier provide? What procedures does the supplier have for assuring on-time deliveries? What procedures does the supplier have for documenting and correcting problems?
Other accounts	Is the supplier heavily dependent on other customers, causing a risk of giving priority to those needs over ours?

before more serious problems develop. Among the factors typically covered by a supplier audit are management style, quality assurance, materials management, the design process used, process improvement policies, and procedures for corrective action and follow-up.

Supplier audits are also an important first step in supplier certification programs.

Supplier Certification

Supplier certification is a detailed examination of the policies and capabilities of a supplier. The certification process verifies that a supplier meets or exceeds the requirements of a buyer. This is generally important in supplier relationships, but it is particularly important when buyers are seeking to establish a long-term relationship with suppliers. Certified suppliers are sometimes referred to as *world class* suppliers. One advantage of using certified suppliers is that the buyer can eliminate much or all of the inspection and testing of delivered goods. And although problems with supplier goods or services might not be totally eliminated, there is much less risk than with noncertified suppliers.

Rather than develop their own certification programs, some companies rely on standard industry certifications such as ISO 9000, perhaps the most widely used international certification.

Supplier Relationship Management

Purchasing has the ultimate responsibility for establishing and maintaining good supplier relationships. The type of relationship is often related to the length of a contract between buyers and sellers. Short-term contracts involve competitive bidding. Companies post specifications and potential suppliers bid on the contracts. Suppliers are kept at arm's length, and the relationship is minimal. Business may be conducted through computerized interaction. Medium-term contracts often involve ongoing relationships. Long-term contracts often evolve into partnerships, with buyers and sellers cooperating on various issues that tend to benefit both parties. Increasingly, business organizations are establishing long-term relationships with suppliers in certain situations that are based on *strategic* considerations.

Some business organizations use *supplier forums* to educate potential suppliers about the organization's policies and requirements and to enhance opportunities for receiving contracts.

Others use supplier forums to share information, strengthen cooperation, and encourage joint thinking. And some organizations use a *supplier code of conduct* that requires suppliers to maintain safe working conditions, treat workers with respect and dignity, and have production processes that do not harm workers, customers, or the environment.

Business organizations are becoming increasingly aware of the importance of building good relationships with their suppliers. In the past, too many firms regarded their suppliers as adversaries and dealt with them on that basis. One lesson learned from the Japanese is that numerous benefits derive from good supplier relations, including supplier flexibility in terms of accepting changes in delivery schedules, quality, and quantities. Moreover, suppliers can often help identify problems and offer suggestions for solving them. Thus, simply choosing and switching suppliers on the basis of price is a very shortsighted approach to handling an ongoing need.

Keeping good relations with suppliers is increasingly recognized as an important factor in maintaining a competitive edge. Many companies are adopting a view of suppliers as partners. This viewpoint stresses a stable relationship with relatively few reliable suppliers who can provide high-quality supplies, maintain precise delivery schedules, and remain flexible relative to changes in productive specifications and delivery schedules. A comparison of the contrasting views of suppliers is provided in Table 15.6.

Supplier Partnerships

More and more business organizations are seeking to establish partnerships with other organizations in their supply chains. This implies fewer suppliers, longer-term relationships, sharing of information (forecasts, sales data, problem alerts), and cooperation in planning. Among the possible benefits are higher quality, increased delivery speed and reliability, lower inventories, lower costs, higher profits, and, in general, improved operations.

There are a number of obstacles to supplier partnerships, not the least of which is that because many of the benefits go to the buyer, suppliers may be hesitant to enter into such relationships. Suppliers may have to increase their investment in equipment, which might put a strain on cash flow. Another possibility is that the cultures of the buyer and supplier might be quite different and not lend themselves to such an arrangement.

Strategic Partnering

Strategic partnering occurs when two or more business organizations that have complementary products or services that would *strategically* benefit the others agree to join so that each may realize a strategic benefit. One way this occurs is when a supplier agrees to hold inventory for a customer, thereby reducing the customer's cost of holding the inventory, in exchange for the customer's agreeing to a long-term commitment, thereby relieving the supplier of the costs that would be needed to continually find new customers, negotiate prices and services, and so on.

Strategic partnering Two or more business organizations that have complementary products or services join so that each may realize a strategic benefit.

Aspect	Adversary	Partner
Number of suppliers	Many; play one off against the others	One or a few
Length of relationship	May be brief	Long-term
Low price	Major consideration	Moderately important
Reliability	May not be high	High
Openness	Low	High
Quality	May be unreliable; buyer inspects	At the source; vendor certified
Volume of business	May be low due to many suppliers	High
Flexibility	Relatively low	Relatively high
Location	Widely dispersed	Nearness is important for short lead times and quick service

TABLE 15.6

Supplier as adversary versus supplier as partner

Collaborative planning, forecasting, and replenishment (CPFR) is a contractual agreement used to achieve supply chain integration by cooperative management of inventory in the supply chain by major supply chain partners. It involves information sharing, forecasting, and joint decision making. If done well, it can lead to cost savings on inventory, logistics, and merchandising for the partners.

15.11 INVENTORY MANAGEMENT

Inventories are a key component of supply chains. Although inventory management is discussed in more detail in several other chapters, certain aspects of inventory management are particularly important for supply chain management. They relate to the location of inventories in the supply chain, the speed at which inventory moves through the supply chain, and dealing with the effect of demand variability on inventories.

The location of inventories is an important factor for effective material flow through the chain and for order fulfillment. Often, trade-offs must be made. One approach is to use centralized inventories, which generally results in lower overall inventory than there would be if decentralized inventories were used, because with decentralized inventories, one location may be understocked, while another location is overstocked. Conversely, decentralized locations can provide faster delivery and generally lower shipping costs.

The rate at which material moves through a supply chain is referred to as **inventory velocity**. The greater the velocity, the lower the inventory holding costs and the faster orders are filled and goods are turned into cash.

Without careful management, demand variations can easily cause inventory fluctuations to get out of control. Variations in demand at the consumer end of a supply chain tend to ripple backward through the chain. Moreover, periodic ordering and reaction to shortages can magnify variations, causing inventories to oscillate in increasingly larger swings. This is known as the **bullwhip effect**, because the pattern of demand variation is analogous to the motion of a bullwhip in response to a slight jerking of the handle. Consequently, shortages and surpluses occur throughout the chain, resulting in higher costs and lower customer satisfaction, unless preventive action is taken. The bullwhip effect is illustrated in Figure 15.4.

The causes of inventory variability can be not only demand variability but also factors such as quality problems, labor problems, unusual weather conditions, and delays in shipments of goods. Adding to this can be communication delays, incomplete communications, and lack of coordination of activities among organizations in the supply chain.

Still other factors can contribute to the bullwhip effect. They include forecast inaccuracies, overreaction to stockouts (customers often order more than they need after experiencing a shortage), order batching to save on ordering and transportation costs (e.g., full truckloads, economic lot sizes), sales incentives, promotions, and quantity discounts, and service and product mix changes, which can create uneven demand patterns and liberal return policies.

Good supply chain management can overcome the bullwhip effect by *strategic buffering* of inventory, information sharing, and inventory replenishment based on needs. An example

Inventory velocity The speed at which goods move through a supply chain.

Bullwhip effect Inventory oscillations become progressively larger looking backward through the supply chain.

FIGURE 15.4

The bullwhip effect: Demand variations begin at the customer end of the chain and become increasingly large as they radiate backward through the chain.

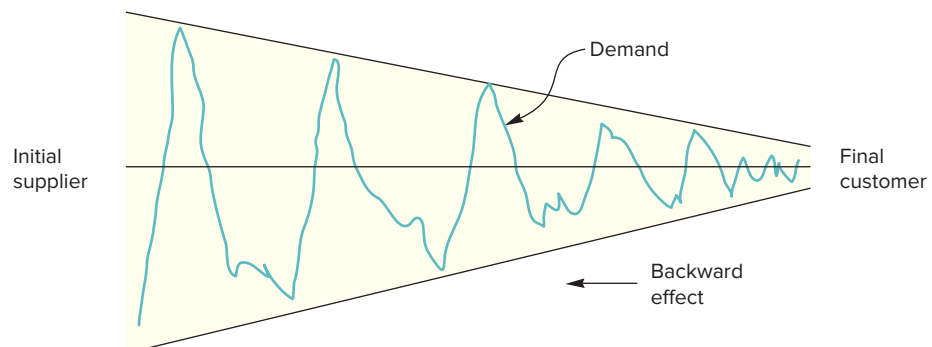



Mike Kane/Bloomberg/Getty Images

Employees assemble Boeing 777 airplanes on a moving production line at the company's facility in Everett, Washington. Airplanes move slowly but at a steady pace toward completion and the hangar door. If there is a production problem along the route, the line stops, responsible teams are alerted, and the issue is addressed until it is resolved.

of strategic buffering would be holding the bulk of retail inventory at a distribution center rather than at retail outlets. That way, inventories of specific retail outlets can be replenished as needed based on point-of-sale information from retail outlets, as well as information on retail outlet inventories.

This is sometimes accomplished using **vendor-managed inventory (VMI)**. Vendors track goods shipped to distributors and retail outlets, and monitor retail supplies, enabling the vendors to replenish inventories when supplies are low. The practice is common in the retail sector, and is also used in other phases of supply chains. VMI lets companies reduce overhead by shifting responsibility for owning, managing, and replenishing inventory to vendors. Not only do assets decrease, the amount of working capital needed to operate a business also decreases.

Vendor-managed inventory (VMI) Vendors monitor goods and replenish retail inventories when supplies are low.

15.12 ORDER FULFILLMENT

Order fulfillment refers to the processes involved in responding to customer orders. Fulfillment time can be an important criterion for customers. It is often a function of the degree of customization required. The following are some common approaches:

Order fulfillment The processes involved in responding to customer orders.

- **Engineer-to-Order (ETO).** With this approach, products are designed and built according to customer specifications. This approach is frequently used for large-scale construction projects, custom homebuilding, home remodeling, and for products made in job shops. The fulfillment time can be relatively lengthy because of the nature of the project, as well as the presence of other jobs ahead of the new one.
- **Make-to-Order (MTO).** With this approach, a standard product design is used, but production of the final product is linked to the final customer's specifications. This approach is used by aircraft manufacturers such as Boeing. Fulfillment time is generally less than with ETO fulfillment, but still fairly long.
- **Assemble-to-Order (ATO).** With this approach, products are assembled to customer specifications from a stock of standard and modular components. Computer manufacturers such as Dell operate using this approach. Fulfillment times are fairly short, often a week or less.

- **Make-to-Stock (MTS).** With this approach, production is based on a forecast, and products are sold to the customer from finished goods stock. This approach is used in department stores and supermarkets. The order fulfillment time is immediate. A variation of this is e-commerce; although goods have already been produced, there is a lag in fulfillment to allow for shipping.

LO15.12 Discuss the logistics aspects of supply chain management, including RFID technology.

Logistics The movement of materials, services, cash, and information in a supply chain.

15.13 LOGISTICS

Logistics refers to the movement of materials, services, cash, and information in a supply chain. Materials include all of the physical items used in a production process. In addition to raw materials and work in process, there are support items such as fuels, equipment, parts, tools, lubricants, office supplies, and more. Logistics includes movement within a facility, overseeing incoming and outgoing shipments of goods and materials, and information flow throughout the supply chain.

Movement within a Facility

Movement of goods within a manufacturing facility is part of production control. Figure 15.5 shows the many steps where materials move within a manufacturing facility:

1. From incoming vehicles to receiving
2. From receiving to storage
3. From storage to the point of use (e.g., a work center)
4. From one work center to the next or to temporary storage
5. From the last operation to final storage
6. From storage to packaging/shipping
7. From shipping to outgoing vehicles

FIGURE 15.5
Movement within a facility

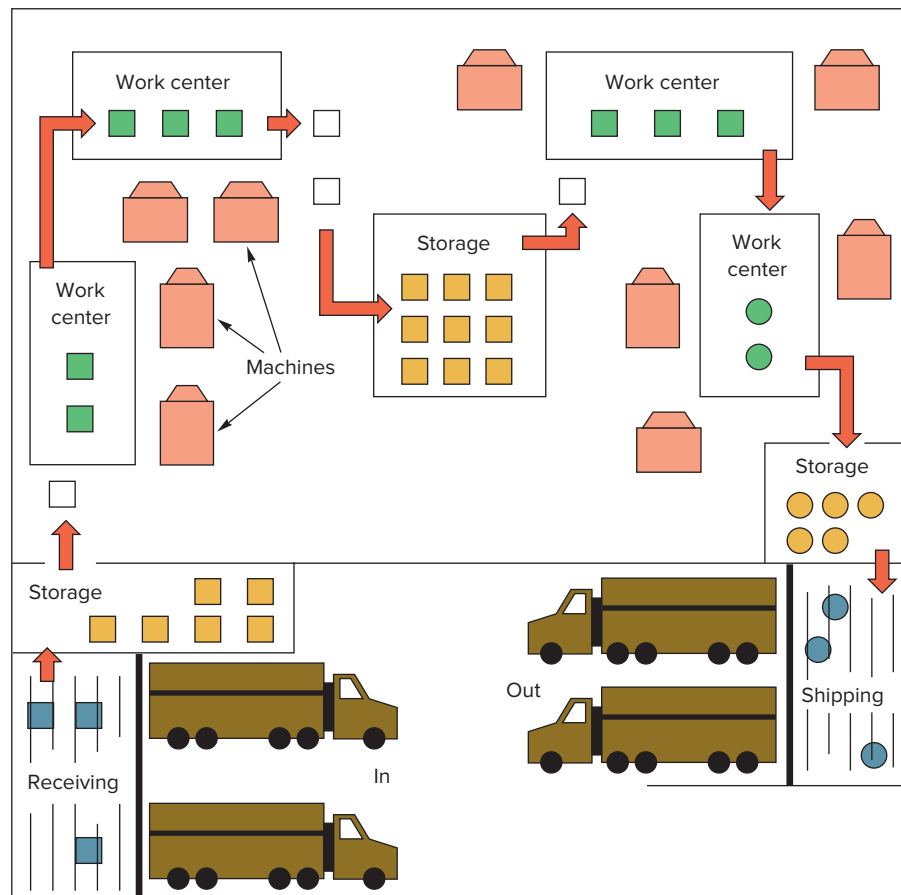

In some instances, the goods being moved are supplies; in other instances, the goods are actual products or partially completed products; and in still other instances, the goods are raw materials or purchased parts.

Movement of materials must be coordinated to arrive at the appropriate destinations at appropriate times. Workers and supervisors must take care so that items are not lost, stolen, or damaged during movement.

OPERATIONS TOUR



WEGMANS' SHIPPING SYSTEM

The Wegmans supermarket chain (see the Wegmans Operations Tour at the end of Chapter 1) has been cited as a leader in supply chain management in the grocery industry. Its distribution system provides a number of examples of strategies and tactics that contribute to its success in managing its supply chain.

Wegmans operates a number of warehouses that are used to supply its stores. Some warehouses stock grocery items, while others stock frozen foods, and still others stock bakery products, seasonal items, and/or produce. Even though all stores and warehouses are owned by Wegmans, the warehouses service the stores on a B2B basis.

Distribution

Individual stores' orders are generated automatically on a daily basis. These are directed to the appropriate warehouses. Order fulfillment begins when a warehouse downloads a store's order to its information system. There are a variety of methods used to replenish stores' inventories. Several of these avoid the need for warehouse storage, saving the company storage and handling costs. Those methods are:

- **Cross-dock:** A full inbound pallet is redirected to an outbound shipment.
- **Cross-distribution:** An inbound pallet is broken down into cases right on the dock, and then the cases are immediately distributed to outbound pallets.
- **Vendor-managed inventory:** Vendors of some non-store brand items, such as bread and soft drinks, handle replenishment, and those items come directly from the vendor's warehouse to the stores.

Warehoused replenishment items are handled as full pallets, or broken down into cases, depending on quantities ordered:

- **Block pick:** An entire pallet of goods in the warehouse is placed on an outbound truck.
- **Case pick:** Individual cases or packages are pulled from inventory, placed on pallets and shrink-wrapped, and then placed on outbound trucks.

Computerized information on incoming orders is checked against incoming shipments of stocks to determine which items can be filled using cross-docking or cross-distribution right in the loading area. These items are then subtracted from a store's order. The remaining items are filled from warehouse supplies.

Warehoused Items

Here is a brief description of retrieval of warehoused items in a dry goods (canned, boxed, etc.) warehouse: The system is semiautomated, and only a few workers are needed to process orders and monitor the system.

Warehoused items are classified for either conveyor belt or non-conveyor belt handling. Items are designated for conveyor belt handling based on their packaging and volume. If volume is low and packaging can withstand the conveyor belt, it will be assigned to the conveyor belt. If the packaging cannot withstand the conveyor belt, the items will be individually case-picked. Non-conveyor belt items that

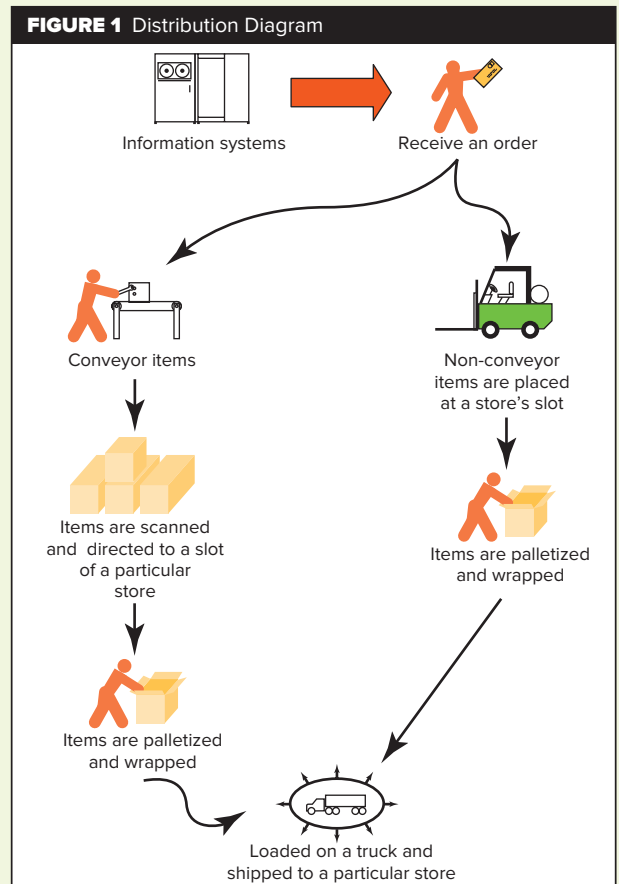

(continued)

(concluded)

are high volume are automatically moved in bulk from their warehouse locations to a staging area to await loading onto an outbound truck.

When orders for conveyor belt items are received, a worker is given bar code labels that contain the number of the ordering store. The worker then goes to the section where an item is stored, affixes the appropriate store bar code, and places the item on the conveyor belt. As items move along the conveyor belt, their bar codes are scanned and they are sorted according to store number. After scanning and sorting, items move to staging areas where they are placed on pallets and shrink-wrapped, and then placed in a slot designated for the appropriate store. The figure illustrates the handling of low-volume items.

Collaboration with Vendors

A desire to improve conveyor belt transporting has led Wegmans to collaborate with vendors in an effort to improve packaging design. Occasionally goods will fall off the belt, and those items have to be inspected to see if they have been damaged. Damaged goods not only are costly, but they are also lost from inventory and must be replaced. Improved packaging also increases the number of goods that can be handled with the conveyor system.

Forecasting

Wegmans implemented a program of consistent low pricing. This program reduced the number of promotional and sale items, reduced much of the volatility in demand, and made forecasting and inventory planning easier.

New Approaches

Wegmans is now using RFID tags. The tags are very small microchips, no bigger than a grain of salt. The tags are somewhat similar to bar codes, but offer greater potential for supply chain management because they can be more quickly read (e.g., multiple items can be scanned at once and, unlike bar codes, no line-of-sight is required for a reading), and scanning devices can be placed in warehouses and even on supermarket shelves that would warn when stocks of individual items are running low. The tags initially cost about \$1 each, and currently cost about five cents each, making them cost effective for tracking shipments and bulk quantities of items, but still too costly to use on individual store items. However, they hold great promise for increasing supply chain visibility and event management capabilities.

Traffic management Overseeing the shipment of incoming and outgoing goods.

Incoming and Outgoing Shipments

Overseeing the shipment of incoming and outgoing goods comes under the heading of **traffic management**. This function handles schedules and decisions on shipping method and times, taking into account costs of various alternatives, government regulations, the needs of the organization relative to quantities and timing, and external factors such as potential shipping delays or disruptions (e.g., highway construction, truckers' strikes).

Computer tracking of shipments often helps to maintain knowledge of the current status of shipments, as well as to provide other up-to-date information on costs and schedules.

Getting to the Right Location

GPS navigation continues to be a valuable asset for deliveries, both to customers and to businesses, guiding drivers or autonomous vehicles to the right location. And cloud-based software helps companies plan efficient routes and delivery schedules. The benefits include efficient routes with less driving time, a reduction in mileage and fuel costs, avoidance of traffic congestion and road closures, and the ability of companies to track their vehicles. Some even enable identifying aggressive driver behavior. GPS navigation is also a valuable asset to service technicians such as plumbers and electricians, emergency services, food delivery, and car services such as Uber and Lyft.

Tracking Goods: RFID

Advances in technology are revolutionizing the way businesses track goods in their supply chains. **Radio frequency identification (RFID)** is a technology that uses radio waves to identify objects, such as goods in supply chains. This is done through an RFID tag that is attached to an object. The tag has an integrated circuit and an antenna that project information or other data to network-connected RFID readers using radio waves. RFID tags can be attached to pallets, cases, or individual items. They provide unique identification, enabling businesses to identify, track, monitor, or locate practically any object in the supply chain that is within range

Radio frequency identification (RFID) A technology that uses radio waves to identify objects, such as goods in supply chains.



UPS SETS THE PACE FOR DELIVERIES AND SAFE DRIVING

BY LISA SPENCER

UPS has implemented policies and rules based on technology and worker training that have increased productivity and safety, and reduced costs. Workers are taught to walk 2.5 paces per second. Keys have given way to proximity key fobs attached to belt loops to get drivers into their vehicles more quickly, saving seconds on each delivery. Entering one less keystroke per driver per day on a hand-held data device saves UPS \$100,000 per year.

The brown delivery truck may look the same on the outside, but technology and big data are changing work that was once primarily manual to a system where nearly every movement can be tracked and monitored. On-board computers gather data all day long, and over 200 sensors on each vehicle can tell if a driver is wearing a seatbelt, opening or closing a door, or using the brakes. Worker safety has increased, as seatbelts are now worn nearly 100 percent of the time. Sensors reveal when the vehicle is started and how fast it is going. They know if the bulkhead door

is open, which street the vehicle is driving on, and the percent of time the vehicle is idling as opposed to being in motion.

Sensors can detect when a driver is backing up, as well as how fast and how far. UPS wants drivers to avoid that practice because it can lead to accidents, and the company tells its workers if they are doing it too much. Using technology and data, UPS increased a typical driver's day by 33 percent while decreasing fuel usage by 8.5 million gallons a year due to better route optimization programs. UPS even uses diagnostic data for preventive maintenance to reduce the downtime surprises.

Based on: Jacob Goldstein, "To increase productivity, UPS monitors drivers' every move." NPR, April 17, 2014, <https://www.npr.org/sections/money/2014/04/17/303770907/to-increase-productivity-ups-monitors-drivers-every-move>

Randy Stashick, "Big data delivers big results at UPS." Production and Operations Management Society Conference, May 11, 2014, <https://pressroom.ups.com/pressroom/ContentDetailsViewer.page?ConceptType=Speeches&id=1426415450350-355>

of a tag reader. These tags are similar to bar codes, but they have the advantage of conveying much more information, and they do not require a line-of-sight for reading that bar codes must have. And unlike bar codes, which must be scanned individually and usually manually, multiple RFID tags can be read simultaneously and automatically. Furthermore, an RFID tag provides more precise information than a bar code: Tags contain detailed information on each object, whereas bar codes convey only an object's classification, such as its stockkeeping unit (SKU). This enables management to know where every object is in the supply chain. RFID has the potential to fundamentally change the way companies track inventory and share information, and to dramatically improve the management of supply chains. This technology increases supply chain visibility, improves inventory management, improves quality control, and enhances relationships with suppliers and customers.



Steven Puetzer/Getty Images

RFID eliminates the need for manual counting and bar-code scanning of goods at receiving docks, in warehouses, and on retail shelves. This eliminates errors and greatly speeds up the process. Tags could reduce employee and customer theft by placing readers at building exits and in parking lots. Still other advantages include increased accuracy in warehouse "picking" of items for shipping or for use in assembly operations, increased accuracy in dispensing drugs to patients in hospitals, and reduced surgical errors.

RFID may enable small, agile businesses to compete with larger, more bureaucratic businesses that may be slow to adopt this new technology. Conversely, large businesses may be better able to afford the costs involved. These include the costs of the tags themselves, as well as the cost of affixing individual tags, the cost of readers, and the cost of computer hardware and software to transmit and analyze the data generated.



The Springdale Farm is a demonstration farm located near Rochester, New York. One area of the farm is dedicated to advances in dairy cow management that involves a unique application of RFID technology. The farm has a milking parlor that features a robotic milking system that has been “trained” on a cow-by-cow basis so it automatically adapts to the physical aspects of each particular cow. When a cow enters the milking parlor, it is immediately identified by its RFID tag, and the milking machine adjusts itself and then attaches itself to the cow for milking. The system includes a self-cleaning, laser-guided robot, plus an automatic feeder, all managed by a software program tied into RFID tags worn by the

cows. The accompanying software keeps track of data regarding the cow’s health, history, milk production, and milk quality. It also allows the cows to be milked whenever they want, without human intervention, freeing workers to focus on other aspects of the operation of the farm. When a cow enters the milking parlor, it is bathed, and then the milking equipment automatically attaches itself to the cow and begins milking. Meanwhile, the cow is given a snack especially formulated for that cow. When the milking is complete, the machine detaches from the cow, the snack is withdrawn, the front door swings open, and the cow exits.

The potential benefits for supply chain management are huge, and widespread adoption of RFID technology by retailers and manufacturers is predicted. In order to take advantage of RFID technology, businesses must first assess the capabilities of their existing information systems, then identify where RFID can have the greatest impact, estimate the time and resources that will be needed to implement the new system, estimate the risks and rewards of early versus late adoption, and then decide the best course of action. Important concerns at the retail level relate to privacy concerns if tags are not deactivated after items have been purchased and placement of tags so they do not hide important customer information on products.

Evaluating Shipping Alternatives

Evaluation of shipping alternatives is an important component of supply chain management. Considerations include not only shipping costs, but also coordination of shipments with other supply chain activities, flexibility, speed, and environmental issues. Shipping options can involve trains, trucks, planes, and boats. Relevant factors include cost, time, availability, materials being shipped, and sometimes environmental considerations. At times, options may be limited due to one or more of these factors. For example, heavy materials such as coal and iron ore would not be shipped by plane. High costs in some cases may rule out certain options. Also, time–cost trade-offs can be important. Organizations using a low-cost strategy often opt for slower, lower cost options, whereas organizations using a responsive strategy more often opt for quicker, higher-cost options.

A situation that often arises in some businesses is the need to make a choice between rapid (but more expensive) shipping alternatives, such as overnight or second-day air, and slower (but less expensive) alternatives. In some instances, an overriding factor justifies sending a shipment by the quickest means possible, so there is little or no choice involved. However, in other instances, urgency is not the primary consideration, so there is a choice. The decision in such cases often focuses on the cost savings of slower alternatives versus the incremental holding cost (here, the annual dollar amount that could be earned by the revenue from the item being shipped) that would result from using the slower alternative. An important assumption is that the seller gets paid upon receipt of the goods by the buyer (e.g., through electronic data interchange).

The incremental holding cost incurred by using the slower alternative is computed as

$$\text{Incremental holding cost} = \frac{H(d)}{365} \quad (15-1)$$

where

H = Annual earning potential of shipped item

d = Difference (in days) between shipping alternatives



Active RFID tags have a transmitter and their own power source, which is typically a battery. The power source is used to run its circuitry and to broadcast a signal to a tag reader. Semi-passive tags use a battery to run the circuitry, but draw power from the reader to communicate with the reader. Passive tags do not have a battery. Instead, like semi-passive tags, they draw power from

the reader. Active and semi-passive tags are especially useful for tracking high-value goods that need to be scanned over long ranges, such as on trucks or railroad cars. However, their high cost relative to passive tag cost doesn't make it economical to use them on low-cost items.

Comparing Costs of Shipping Alternatives

EXAMPLE 1

Determine which shipping alternative, one day or three days, is best when the holding cost of an item is \$1,000 per year, the one-day shipping cost is \$40, and the three-day shipping cost is:

- \$35
- \$30

SOLUTION

$H = \$1,000$ per year

Time savings = 2 days using 1-day shipping

Holding cost for additional 2 days = $\$1,000 \times (2/365) = \5.48

- Cost savings = \$5. Because the actual savings of \$5 is less than the holding cost (\$5.48), use the one-day alternative.
- Cost savings = \$10. Because the actual savings of \$10 exceeds the savings in holding cost of \$5.48, use the three-day alternative.

3-PL

Third-party logistics (3-PL) is the term used to describe the outsourcing of logistics management. According to the website of the Council of Supply Chain Management Professionals, the legal definition of a 3PL is “A person who solely receives, holds, or otherwise transports a consumer product in the ordinary course of business but who does not take title to the product.”

This might involve part or even all of the logistics function. For example, some companies use third-party providers just for shipping, others include warehousing and distribution, and still others rely on third-party companies to manage most or all of their supply chains. Companies are turning over warehousing and distribution to companies that specialize in these areas. Among the potential benefits of this are taking advantage of specialists' knowledge, their well-developed information system, and their ability to obtain more favorable shipping rates, and enabling the company to focus more on its core business.

Third-party logistics (3-PL)

The outsourcing of logistics management.

15.14 CREATING AN EFFECTIVE SUPPLY CHAIN

Creating an effective supply chain requires a thorough analysis of all aspects of the supply chain. Strategic sourcing is a term sometimes used to describe the process. **Strategic sourcing** is a systematic process for analyzing the purchase of products and services to reduce costs by reducing waste and non-value-added activities, increase profits, reduce risks, and improve supplier performance. Strategic sourcing differs from more traditional sourcing in that it emphasizes total cost rather than purchase price. Total cost includes storage costs, repair costs, disposal costs, and sustainability costs in addition to purchase price. It also seeks to consolidate purchasing power to achieve lower prices, relies on fewer suppliers and collaborative relationships, works to eliminate redundancies, and employs cross-functional teams to help overcome traditional organizational barriers.

Strategic sourcing Analyzing the procurement process to lower costs by reducing waste and non-value-added activities, increase profits, reduce risks, and improve supplier performance.

Strategic sourcing looks at current procurement in terms of what is bought, where and from what suppliers it is bought, and what other sources of supply are available; a sourcing strategy then is designed to minimize a combination of costs and risks. The goal is to have a cooperative relationship among supply chain partners that will facilitate planning and coordination of activities. It is essential for major trading partners to trust each other and to feel confident that partners share similar goals and will take actions that are mutually beneficial. The process is repeated periodically. A system for tracking results and making changes when needed is also established.

The SCOR[®] (Supply Chain Operations Reference) model (www.supply-chain.org/SCOR) provides steps that can be used to create an effective supply chain:

1. **Plan.** Develop a strategy for managing all the resources that go into meeting expected customer demand for a product or service, including a set of metrics to monitor the supply chain.
2. **Source.** Select suppliers that will provide the goods and services needed to create products or support services. Also, develop a system for delivery, receiving, and verifying shipments or services. Structure payment along with metrics for monitoring and, if necessary, improving relationships.
3. **Make.** Design the processes necessary for providing services or producing, testing, and packaging goods. Monitor quality, service levels or production output, and worker productivity.
4. **Deliver.** Establish systems for coordinating receipt of shipments from vendors; develop a network of warehouses; select carriers to transport goods to customers; set up an invoicing system to receive payments; and devise a communication system for two-way flow of information among supply chain partners.
5. **Manage returns.** Create a responsive and flexible network for receiving defective and excess products from customers.

Achieving an effective supply chain requires integration of all aspects of the supply chain. Three important aspects of this are effective communication, the speed with which information moves through the supply chain, and having performance metrics.

Effective communication. Effective supply chain communication requires integrated technology and standardized ways and means of communicating among partners.

Information velocity. **Information velocity** is important; the faster information flows (two-way), the better.

Performance metrics. Performance metrics are necessary to confirm that the supply chain is functioning as expected, or that there are problems that must be addressed. A variety of measures can be used, which relate to such things as late deliveries, inventory turnover, response time, quality issues, and so on. In the retail sector, the **fill rate** (the percentage of demand filled from stock on hand) is often very important.

Table 15.7 lists some other key performance measures.

Information velocity The speed at which information is communicated in a supply chain.

Fill rate The percentage of demand filled from stock on hand.

TABLE 15.7
Supply chain performance measures

Financial	Operations	Order fulfillment
Return on assets	Productivity	Order accuracy
Cost	Quality	Time to fill orders
Cash flow		Percentage of incomplete orders shipped
Profits		Percentage of orders delivered on time
Suppliers	Inventory	Customers
Quality	Average value	Customer satisfaction
On-time delivery	Turnover	Percentage of customer complaints
Cooperation	Weeks of supply	
Flexibility		



The term “clicks-or-bricks” refers to a business model in which a company has either an online (clicks) or an offline (bricks) presence. Many companies have both. Sometimes that business model is referred to as “clicks-and-mortar” or “clicks-and-bricks.” In one version, a chain store may allow a customer to order goods online and pick them up at a local store. In another version, large items such as appliances or furniture may be viewed at a local store and then ordered electronically for home delivery. In both instances, the “bricks” portion necessitates a location decision.

Even companies that are seemingly pure “clicks,” selling electronic products such as computers, still have warehousing and delivery facilities behind businesses that trade in material goods. Again, location decisions are necessary.

The choice of which business model to use requires taking into account the costs of having a physical presence and what the balance between the two should be. Of course, customer preferences and shopping patterns are important. For example, some reasons people shop online include ease of price comparison,

convenience, availability of hard-to-find items, research recommendations, and elimination of the need to travel. Reasons for offline shopping include immediate possession of an item, ease of returns, the security risks of online shopping, the need to use a credit card, the burden of logistics for returns, and ability to “kick the tires” (e.g., try on clothing or footwear, judge quality).

Questions

1. Retail outlets that do not have an internet presence often complain that consumers come in to “kick the tires,” but then buy online from a competitor. Can you suggest some ways outlets can overcome that?
2. Some customers of internet businesses can avoid paying state sales taxes on purchases if the internet businesses don’t have a physical presence in their state. However, more states are enacting laws to collect taxes. What impact might this have on the clicks, bricks, or both choices?

Managing Returns

Products are returned to companies or third-party handlers for a variety of reasons, and in a variety of conditions. Among them are the following:

- Defective products
- Recalled products
- Obsolete products
- Unsold products returned from retailers
- Parts replaced in the field
- Items for recycling
- Waste

The importance of returns is underscored by the fact that in the United States, the annual value of returns is estimated to be in the neighborhood of \$100 billion. In the past, most items—except unsold products—were typically discarded. More recently, companies are recognizing that substantial value can be reclaimed from returned items. For example, defective parts can be repaired or replaced, and products can be resold as reconditioned. Obsolete products may have usable parts or subassemblies, or they may have value in other markets. Parts replaced in the field may in fact not be defective at all; it is estimated that about a third of such parts are not defective and may be reusable as “reconditioned” replacement parts. Recyclable items can be sold to recyclers and might be usable for energy production; other waste and unusable products and parts might require disposal according to sometimes stringent guidelines. For example, governments, particularly in Europe, are increasingly enacting legislation making original manufacturers responsible for acquiring and disposing of their products at the end of their products’ useful lives.

To make a determination as to the appropriate disposition of returned items, the items must be sorted, inspected, or tested and directed to the appropriate destination for repair and reuse, recycling, or disposal. Often, transportation is required. **Reverse logistics** is the process of physically transporting returned items. This involves either retrieving items from the field or moving items from the point of return to a facility where they will be inspected and sorted and then transporting them to their final destination.

LO15.13 Discuss the issues involved in managing returns.

Reverse logistics The process of transporting returned items.



BY LISA SPENCER

As e-commerce has grown, so have returns, and the company Happy Returns is there to help consumers. To save them the hassle of sending their returns and waiting to get their refunds, Happy Returns offers an easier alternative: Drop off your package in one of its user-friendly kiosks in over 300 locations across the country and get refunded in real time. Return kiosks or “bars” are located in stores, shopping malls, and college bookstores across the United States. Using the kiosk involves a 60-second process, where the customer accesses the original order on an integrated tablet, chooses the appropriate item, and opts to either return or exchange it. The item is then put through a tamper-proof door in the kiosk, and the refund is processed. Happy Returns takes over from there.

The system benefits retailers as well, simplifying the process and lowering costs by aggregating returns from multiple customers

and returning items in bulk. From kiosks, the items travel to return hubs, where they are inspected and grouped based on the retailer to which they will be shipped.

Questions

1. What are the advantages and disadvantages of the Happy Returns process for retailers?
2. What example does this provide for future entrepreneurs?

Based on: “Happy Returns launches self-service return solution to eliminate the pain of buy-online-return-in-store for omni-channel retailers and their customers.” March 4, 2019. <https://www.businesswire.com/news/home/20190304005045/en/Happy-Returns-Launches-Self-Service-Return-Solution>

Vishnu Rajamanickam. “Happy Returns launches a kiosk that takes ecommerce returns items.” *Freightwaves*, March 4, 2019. <https://www.freightwaves.com/news/technology/happy-returns-launches-a-kiosk-that-takes-ecommerce-return-items>

An Amazon.com employee inspects returned products at a distribution warehouse in Nevada. The returned goods are inspected for restocking if in pristine condition, forwarded to a repair center if necessary, inventoried, and examined for potential product, process, or packaging improvements if they are defective.



Mark Richard/PhotoEdit

Gatekeeping Screening returned goods to prevent incorrect acceptance of goods.

Avoidance Finding ways to minimize the number of items that are returned.

Two key elements of managing returns are *gatekeeping* and *avoidance*. **Gatekeeping** oversees the acceptance of returned goods with the intent of reducing the cost of returns by screening returns at the point of entry into the system and refusing to accept goods that should not be returned, or goods that are returned to the wrong destination. Effective gatekeeping enables organizations to control the rate of returns without negatively impacting customer service. **Avoidance** refers to finding ways to minimize the number of items returned. It can involve product design and quality assurance. It may also involve monitoring forecasts during promotional programs to avoid overestimating demand to minimize returns of unsold product.

The condition of returned products, as well as the timing of returns, may vary, making it difficult to plan for the reverse flow. On the other hand, returns can provide valuable information, such as how and why failures occurred, which can improve product quality and/or

product design and minimize future returns for that reason. They can also help identify some sources of customer dissatisfaction, which can have design benefits.

It is likely that the importance of this aspect of supply chain management will grow due to shortened product life cycles, increasing returns from increasing internet commerce sales from dissatisfied customers, replacement of consumer electronics that are in working order as newer models become available, pressures on manufacturers to reduce costs, and increasing consumer and government environmental concerns. The term **closed-loop supply chain** is used to describe a situation where a manufacturer controls both the forward and reverse logistics.

Closed-loop supply chain A manufacturer controls both the forward and reverse shipment of product.

Challenges

The often dynamic supply chain environment and the complexity of supply chains can make managing them very challenging.

Barriers to Integration of Separate Organizations. Organizations, and their functional areas, have traditionally had an inward focus. They set up buffers between themselves and their suppliers. Changing that attitude can be difficult. The objective of supply chain management is to be efficient across the entire supply chain.

LO15.14 Describe some of the challenges in creating an effective supply chain and some of the trade-offs involved.

One difficulty in achieving this objective is that different components of the supply chain often have conflicting objectives. For example, to reduce their inventory holding costs, some companies opt for frequent small deliveries of supplies. This can result in increased holding costs for suppliers, so the cost is merely transferred to suppliers. Similarly, within an organization, functional areas often make decisions with a narrow focus, doing things that “optimize” results under their control; in so doing, however, they may suboptimize results for the overall organization. To be effective, organizations must adopt a *systems approach* to both the internal and external portions of their supply chains, being careful to make decisions that are consistent with optimizing the supply chain.

Another difficulty is that for supply chain management to be successful, organizations in the chain must allow other organizations access to their data. There is a natural reluctance to do this in many cases. One reason can be lack of trust; another can be unwillingness to share proprietary information in general; and another can be that an organization, as a member of multiple chains, fears exposure of proprietary information to competitors.

Getting CEOs, Boards of Directors, Managers, and Employees “Onboard.” CEOs and boards of directors need to be convinced of the potential payoffs from supply chain management. And because much of supply chain management involves a change in the way business has been practiced for an extended period of time, getting managers and workers to adopt new attitudes and practices that are consistent with effective supply chain operations poses a real challenge.

Making the Supply Chain More Efficient.

1. **Large vs. small lot sizes.** Compare the benefits and costs of large lots (quantity discounts and lower setup costs, but larger carrying costs) with the benefits and risks of small lots (agility, the possibility of shorter lead times from not needing to wait for production of larger lot quantities, and lower carrying costs, but increased risk of stockouts). Note, too, that use of large lots can contribute to the bullwhip effect.
2. **Saving cost and time by using cross-docking.** **Cross-docking** is a technique whereby goods arriving at a warehouse from a supplier are unloaded from the supplier’s truck and immediately loaded on one or more outbound trucks, thereby avoiding storage at the warehouse completely. Walmart is among the companies that have used this technique successfully to reduce inventory holding costs and lead times.
3. **Increase the perception of variety while taking advantage of the benefits of low variety by using delayed differentiation.** **Delayed differentiation** involves producing

Cross-docking A technique whereby goods arriving at a warehouse from a supplier are unloaded from the supplier’s truck and loaded onto outbound trucks, thereby avoiding warehouse storage.

Delayed differentiation Production of standard components and subassemblies, which are held until late in the process to add differentiating features.

standard components and subassemblies, and then delaying until late in the process to add differentiating features. For example, an automobile producer may allow dealers to add (or subtract) certain features for customers, increasing the appeal of vehicles while reducing the need to maintain large inventories of vehicles to be able to satisfy different customer wants. Similarly, a bakery can produce “standard” cakes that can be decorated (e.g., Happy Birthday Baby!) according to a customer’s specifications.

4. **Ship directly to the customer to reduce waiting time.** One approach to reducing the time customers must wait for their orders is to ship directly from a warehouse to the customer, bypassing a retail outlet. Another approach used by some supermarkets is to have employees do the shopping based on customer orders. This may include delivery to the customer, or provide for customer pickup of an order. When one or more steps in a supply chain are eliminated, that is referred to as **disintermediation**. Aside from reducing waiting time, storage costs are avoided, although delivery costs are higher. Allowing store pickups can reduce transportation costs.

Disintermediation Reducing one or more steps in a supply chain by cutting out one or more intermediaries.

Small Businesses. Small businesses may be reluctant to embrace supply chain management because it can involve specialized, complicated software, as well as sharing sensitive information with outside companies. Nonetheless, in order for them to survive, they may have to do so.

Variability and Uncertainty. Variations create uncertainty, thereby causing inefficiencies in a supply chain. Variations occur in incoming shipments from suppliers, internal operations, deliveries of products or services to customers, and customer demands. Increases in product and service *variety* add to uncertainty, because organizations have to deal with a broader range and frequent changes in operations. Hence, when deciding to increase variety, organizations should consider this trade-off.

Although variations exist throughout most supply chains, decision makers often treat the uncertainties as if they were certainties and make decisions on that basis. In fact, systems are often designed on the basis of certainty, so they may not be able to cope with uncertainty. Unfortunately, uncertainties are detrimental to effective management of supply chains because they result in various undesirable occurrences, such as inventory buildups, bottleneck delays, missed delivery dates, and frustration for employees and customers at all stages of a supply chain.

Response Time. Response time is an important issue in supply chain management. Long lead times impair the ability of a supply chain to quickly respond to changing conditions, such as changes in the quantity or timing of demand, changes in product or service design, and quality or logistics problems. Similarly, long delivery lead times can be a competitive disadvantage. Therefore, it is important to work to reduce long product lead times, long collaborative lead times, and long delivery lead times. Also, a plan should be in place to deal with problems when they arise.

15.15 STRATEGY

Effective supply chains are critical to the success of business organizations. Development of supply chains should be accorded strategic importance. Achieving an effective supply chain requires integration of all aspects of the chain. Supplier relationships are a critical component of supply chain management. Collaboration and joint planning and coordination are keys to supply chain success. In that regard, a systems view of the supply chain is essential.

Many businesses are employing principles of lean operations and six sigma methodology to improve supply chain performance. However, lean supply chains can increase supply chain risk and may necessitate increased inventories to offset those risks.

A supply chain consists of all of the organizations, facilities, functions, and activities involved in producing a product or providing a service. The chapter provides a list of strategic, tactical, and operational responsibilities related to supply chain management. The chapter covers key issues, recent trends, procurement, ethical behavior, e-business, supplier management, inventory management, returns management, and risk management.

The basic components of supply chain management are strategy formulation, procurement, supply management, demand management, and logistics management. The key issues in supply chain management relate to determining the appropriate level of outsourcing, managing procurement, managing suppliers, managing customer relationships, being able to quickly identify problems and respond to them, and managing risk.

The goal of supply chain management is to match supply and demand as effectively and efficiently as possible. Because supply chains are made up of multiple organizations, cooperation and collaboration among supply chain partners is very important. Supply chain functioning benefits from mutual trust, information sharing, and collaborative forecasting and planning.

Recent trends in supply chain management relate to managing risk, reevaluating outsourcing, managing inventories, and applying lean principles to improve supply chain performance.

1. Supply chains are a vital part of every business organization and need to be managed effectively to achieve a balance of supply and demand.
2. Among important trends in supply chain management are measuring ROI, “greening” the supply chain, reevaluating outsourcing, integrating IT, managing risks, adopting lean principles, being agile, and being transparent.
3. It is important for businesses to encourage their supply chain partners to act ethically.
4. Effective supply chains involve trust, communication, a rapid two-way flow of information, visibility, and event-response capability.

avoidance, 684
 bullwhip effect, 674
 centralized purchasing, 669
 closed-loop supply chain, 685
 cross-docking, 685
 decentralized purchasing, 669
 delayed differentiation, 685
 disintermediation, 686
 e-business, 670
 event-response capability, 662
 fill rate, 682

gatekeeping, 684
 information velocity, 682
 inventory velocity, 674
 logistics, 656, 676
 order fulfillment, 675
 purchasing cycle, 667
 reverse logistics, 683
 radio frequency identification (RFID), 678
 resiliency, 661
 strategic partnering, 673

strategic sourcing, 681
 supply chain, 656
 supply chain management, 656
 supply chain visibility, 662
 third-party logistics (3-PL), 681
 traffic management, 678
 vendor analysis, 671
 vendor-managed inventory (VMI), 675

1. What is a supply chain?
2. What are some recent trends in supply chain management?
3. What are the elements of supply chain management?
4. What are the strategic, tactical, and operations responsibilities in supply chain management?
5. What is the bullwhip effect, and why does it occur? How can it be overcome?
6. Explain the increasing importance of the procurement function.
7. What is meant by the term *inventory velocity* and why is this important? What is *information velocity*, and why is it important?
8. Explain strategic partnering.
9. What impact has e-business had on supply chain management?
10. What are some of the advantages of e-business?
11. What are some of the trade-offs that might be factors in designing a supply chain?
12. Why is managing returns important?
13. Explain the importance of supply chain visibility.
14. Describe what purchasing managers do.

SUMMARY

KEY POINTS

KEY TERMS

DISCUSSION AND REVIEW QUESTIONS

15. Describe how purchasing interacts with two other functional areas of an organization.
16. Discuss the importance of RFID for supply chain management.
17. Discuss centralization versus decentralization in purchasing. What are the advantages of each?
18. Describe vendor analysis.
19. Describe supplier certification and explain why it can be important.
20. Compare viewing suppliers as adversaries with viewing them as partners.
21. Explain the benefit of cross-docking.

TAKING STOCK

1. What trade-offs are involved in (a) sharing information with other organizations in a supply chain and (b) the acquisition of information-processing technology?
2. Who needs to be involved in (a) decisions on technology acquisition for supply chain management and (b) supply chain management?
3. Name three different ways that technology has improved the ability to manage supply chains.

CRITICAL THINKING EXERCISES

1. Explain why each of these is critical for a successful supply chain operation:
 - a. Integrated technology
 - b. Information sharing
 - c. Trust among trading partners
 - d. Real-time information availability
 - e. Event-response capability
 - f. Procurement
 - g. Risk management
 - h. Agility
2. Given the complexities and risks involved with supply chains, might it make sense for a business organization to vertically integrate and be its own supply chain?
3. From a systems viewpoint, what are some of the environmental issues involved in a decision by a company to outsource manufacturing operations to a foreign country?
4. Select three of the examples of unethical behavior in section 15.5, other than those that violate basic human rights, and indicate which principle in Table 15.2 would be violated.

PROBLEMS

1. A manager at Strateline Manufacturing must choose between two shipping alternatives: two-day freight and five-day freight. Using five-day freight would cost \$135 less than using two-day freight. The primary consideration is holding cost, which is \$10 per unit a year. Two thousand items are to be shipped. Which alternative would you recommend? Explain.
2. Determine which shipping alternative would be most economical to ship 80 boxes of parts when each box has a price of \$200 and holding costs are 30 percent of price, given this shipping information: overnight, \$300; two-day, \$260; six-day, \$180.
3. A manager must make a decision on shipping. There are two shippers: A and B. Both offer a two-day rate: A for \$500, and B for \$525. In addition, A offers a three-day rate of \$460 and a nine-day rate of \$400, and B offers a four-day rate of \$450 and a seven-day rate of \$410. Annual holding costs are 35 percent of unit price. Three hundred boxes are to be shipped, and each box has a price of \$140. Which shipping alternative would you recommend? Explain.



BY NICOLE FOSTER, GRAND VALLEY STATE UNIVERSITY

When MasterTag was founded in 1949, its founder, Ludwig Schmidt, set out to be a manufacturer of plastic fishing bobbers. Then, in 1950, Mr. Schmidt was approached by a local greenhouse owner and was asked if he could produce a line of horticultural labels for plants. At the time, these labels were made of wood. Mr. Schmidt adapted his machines to produce these labels and has been manufacturing the plastic “tags” for plants ever since. Over the years, the labels have increased in quality and now feature full-color pictures of the plants, along with their name and planting and care instructions.

Many of MasterTag’s largest customers are seed companies that sell the seeds to commercial growers. The large seed companies typically place one or two large orders with MasterTag at the beginning of the growing season. The seed companies then sell their seeds and the labels to their customers who grow the plants and sell them to the end consumer. For various reasons, the seed companies do not like ordering tags, but do so because their customers demand labels with their seeds.

However, there are several problems with this ordering process. The main issue stems from the fact that the exact quantities of tags that will be needed is difficult to predict due to possible crop failures and the introduction of new items. To avoid a shortage of tags, seed companies order and ship a large quantity of tags to their customers. Tags are ordered early to allow for the time needed to incorporate the tags with the seeds. Seed companies usually end up each year with huge numbers of leftover tags. In fact, MasterTag’s largest customers often end up with millions of leftover tags.

When MasterTag’s management became aware of all the unused labels and unhappy customers, they decided they must come up with a better solution for achieving a match between supply and demand of the tags. One possible solution would be to make an initial, fairly large batch, which would be produced and shipped directly to the growers instead of the seed companies, as is now being done. Later, when the grower results became available, a second batch would be produced using information from growers on how many additional tags are needed. The second batch would then be made and shipped to the growers. (See figure for Before and After.)

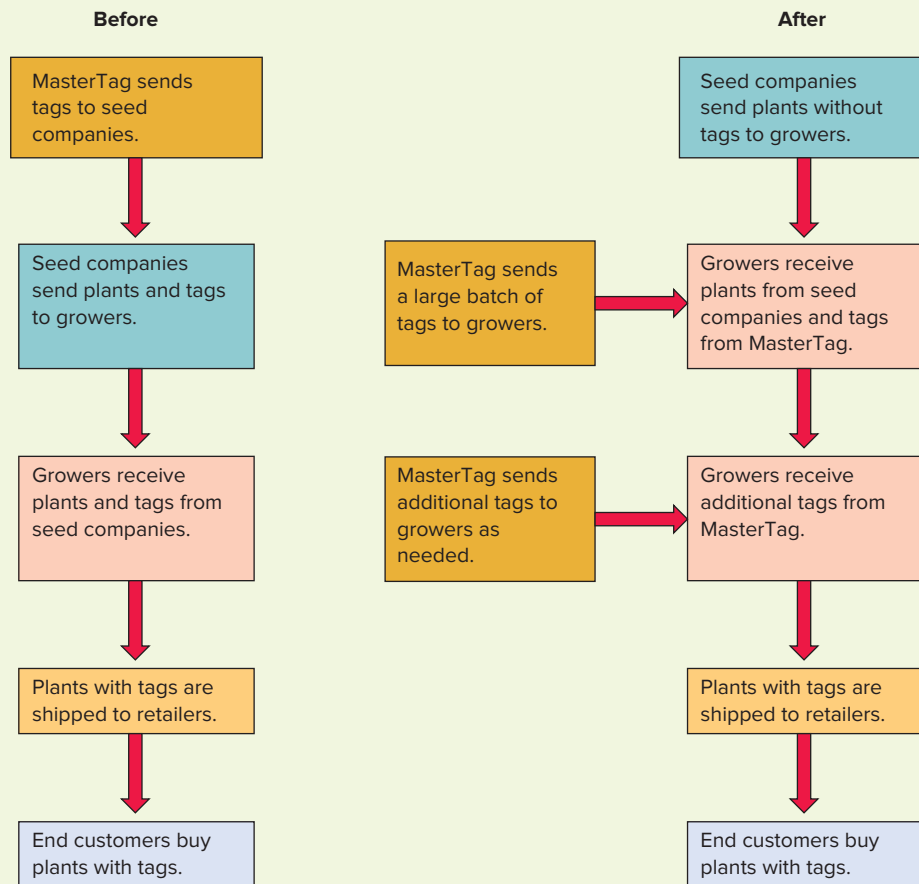

Questions

1. Explain the key benefit of the revised approach, and the reason for the benefit.

2. MasterTag has not yet decided to implement this plan. List the pros and cons you think should be considered.

**SELECTED
BIBLIOGRAPHY AND
FURTHER READINGS**

- Benton, W. C. *Purchasing and Supply Chain Management*, 3rd ed. New York: McGraw-Hill, 2013.
- Bowersox, Donald J., David J. Closs, and M. Bixby Cooper. *Supply Chain Logistics Management*, 5th ed. New York: McGraw-Hill Education, 2019.
- Chopra, Sunil. *Supply Chain Management: Strategy, Planning, and Operation*, 7th ed. New York: Pearson, 2018.
- Handfield, Robert B., and Ernest L. Nichols Jr. *Introduction to Supply Chain Management*, 2nd ed. Upper Saddle River, NJ: Prentice Hall, 2014.
- Johnson, P. Fraser, Michiel R. Leenders, and Anna E. Flynn. *Purchasing and Supply Management*, 14th ed. New York: McGraw-Hill/Irwin, 2011.
- Monczka, Robert M., Robert H. Handfield, Larry Guinipero, and James Patterson. *Purchasing and Supply Chain Management*, 6th ed. Stamford, CT: South-Western Cengage Learning, 2016.
- Murphy, Paul R. Jr., and A. Michael Knemeyer. *Contemporary Logistics*, 12th ed. Pearson, 2017.
- RFID Journal.com*
- Simchi-Levi, David, Philip Kaminsky, and Edith Simchi-Levi. *Designing and Managing the Supply Chain: Concepts, Strategies, and Case Studies*, 3rd ed. New York: McGraw-Hill, 2008.
- Webster, Scott. *Principles and Tools for Supply Chain Management*. New York: McGraw-Hill, 2009.

16 Scheduling

CHAPTER

LEARNING OBJECTIVES

After completing this chapter, you should be able to:

- LO16.1** Explain what scheduling involves and the importance of good scheduling.
- LO16.2** Compare product and service scheduling hierarchies.
- LO16.3** Describe scheduling needs in high-volume systems.
- LO16.4** Describe scheduling needs in intermediate-volume systems.
- LO16.5** Describe scheduling needs in job shops.
- LO16.6** Use and interpret Gantt charts.
- LO16.7** Use the assignment method for loading.
- LO16.8** Give examples of commonly used priority rules.
- LO16.9** Discuss the theory of constraints and that approach to scheduling.
- LO16.10** Summarize some of the unique problems encountered in service systems, and describe some of the approaches used for scheduling service systems.

CHAPTER OUTLINE

- 16.1 Scheduling Operations** 694
 - Scheduling in High-Volume Systems 694
 - Scheduling in Intermediate-Volume Systems 696
- 16.2 Scheduling in Low-Volume Systems** 697
 - Loading 697
 - Sequencing 704
 - Sequencing Jobs through Two Work Centers 711
 - Sequencing Jobs When Setup Times Are Sequence-Dependent 713
 - Why Scheduling Can Be Difficult 713
 - Minimizing Scheduling Difficulties 714
 - The Theory of Constraints 714
- 16.3 Scheduling Services** 715
 - Appointment Systems 716
 - Reservation Systems 716
 - Yield Management 716
 - Scheduling the Workforce 717
 - Cyclical Scheduling 717
 - Scheduling Multiple Resources 718
- 16.4 Operations Strategy** 719
 - Case:** Hi-Ho, Yo-Yo, Inc. 731



Ulrich Baumgarten/Getty Images

Airline travel can be difficult when flights are delayed or canceled due to weather problems. And even though it may be clear and dry in some areas, flights in those places can still be affected by weather in other areas. Because of all the interdependencies, a problem in one area, especially around major hub airports like Chicago, Atlanta, and New York, has a cascading effect with impacts throughout the nation. This results in massive scheduling problems. Flight arrivals and departures have to be rescheduled, which then means flight crews, terminal gates, connections, and baggage and freight also must be rescheduled. Airline and air traffic control software scheduling systems include and optimize thousands of variables.

Within an organization, **scheduling** pertains to establishing the timing of the use of specific resources of that organization. It relates to the use of equipment, facilities, and human activities. Scheduling occurs in every organization, regardless of the nature of its activities. For example, manufacturers must schedule production, which means developing schedules for workers, equipment, purchases, maintenance, and so on. Hospitals must schedule admissions, surgery, nursing assignments, and support services such as meal preparation, security, maintenance, and cleaning. Educational institutions must schedule classrooms, instruction, and students. And lawyers, doctors, dentists, hairdressers, and auto repair shops must schedule appointments. In addition, in many situations, there are unscheduled arrivals that must be dealt with. For instance, auto repair shops often have drive-in customers; barber shops and others may advertise “No appointment necessary.”

In the decision-making hierarchy, scheduling decisions are the final step in the transformation process before actual output occurs. Many decisions about system design and operation have been made long before scheduling decisions.

Scheduling Establishing the timing of the use of equipment, facilities, and human activities in an organization.

LO16.1 Explain what scheduling involves and the importance of good scheduling.

continued

They include the capacity of the system, product or service design, equipment selection, selection and training of workers, and aggregate planning and master scheduling. Consequently, scheduling decisions must be made within the constraints established by many other decisions, making them fairly narrow in scope and latitude. Figure 16.1 depicts scheduling hierarchies for manufacturing and service scheduling.

Effective scheduling can yield cost savings, increases in productivity, and other benefits. For example, in hospitals, effective scheduling can save lives and improve patient care. In educational institutions, it can reduce the need for expansion of facilities. In competitive environments, effective scheduling can give a company a competitive advantage in terms of customer service (shorter wait time for their orders) if its competitors are less effective with their scheduling.

Generally, the objectives of scheduling are to achieve trade-offs among conflicting goals, which include efficient utilization of staff, equipment, and facilities, and minimization of customer waiting time, inventories, and process times.

This chapter covers scheduling in both manufacturing and service environments. Although the two environments have many similarities, some basic differences are important.

FIGURE 16.1
Scheduling hierarchies

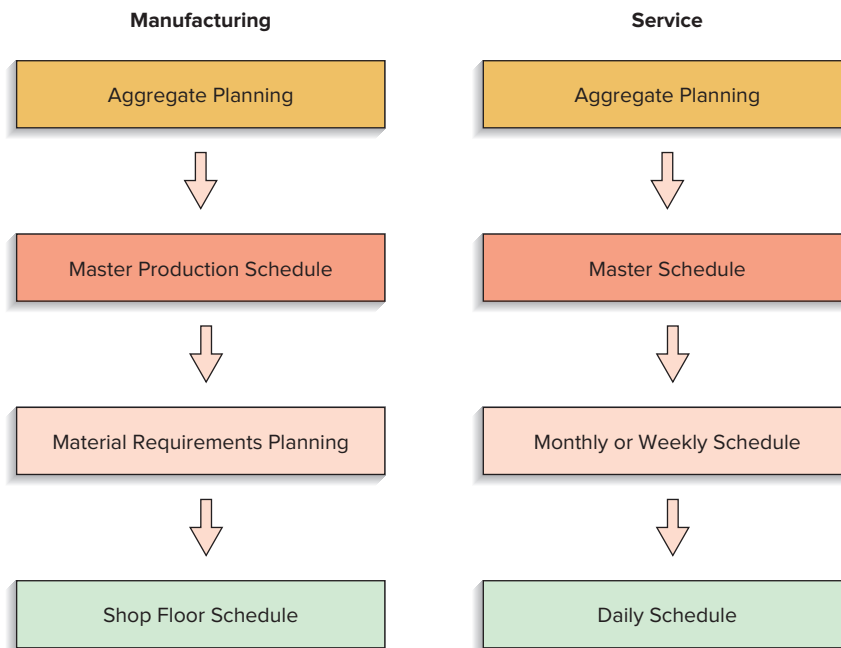

LO16.2 Compare product and service scheduling hierarchies.

LO16.3 Describe scheduling needs in high-volume systems.

16.1 SCHEDULING OPERATIONS

Scheduling tasks are largely a function of the volume of system output for both production and service systems. High-volume systems require approaches substantially different from those required by job shops, and project scheduling requires still different approaches. In this chapter, we will consider scheduling for high-volume systems, intermediate-volume systems, and low-volume (job shop) scheduling. Project scheduling is discussed in Chapter 17.

Scheduling in High-Volume Systems

Scheduling encompasses allocating workloads to specific work centers and determining the sequence in which operations are to be performed. High-volume systems are characterized by standardized equipment and activities that provide identical or highly similar operations on customers or products as they pass through the system. The goal is to obtain a smooth rate of flow of goods or customers through the system in order to get a high utilization of labor and equipment. High-volume systems, where jobs follow the same sequence, are often referred to

as **flow systems**; scheduling in these systems is referred to as **flow-shop scheduling**, although flow-shop scheduling also can be used in medium-volume systems. Examples of high-volume products include autos, smartphones, radios and televisions, office supplies, toys, and appliances. In process industries, examples include petroleum refining, sugar refining, mining, waste treatment, and the manufacturing of fertilizers. Examples of services include cafeteria lines, news broadcasts, and mass inoculations. Because of the highly repetitive nature of these systems, many of the loading and sequence decisions are determined during the design of the system. The use of highly specialized tools and equipment, arrangement of equipment, use of specialized material-handling equipment, and division of labor are all designed to enhance the flow of work through the system, because all items follow virtually the same sequence of operations.

A major aspect in the design of flow systems is *line balancing*, which concerns allocating the required tasks to workstations so that they satisfy technical (sequencing) constraints and are balanced with respect to equal work times among stations. Highly balanced systems result in the maximum utilization of equipment and personnel, as well as the highest possible rate of output. Line balancing was discussed in Chapter 6.

In setting up flow systems, designers must consider the potential discontent of workers in connection with the specialization of job tasks in these systems; high work rates are often achieved by dividing the work into a series of relatively simple tasks assigned to different workers. The resulting jobs tend to be boring and monotonous and may give rise to fatigue, absenteeism, turnover, and other problems, all of which tend to reduce productivity and disrupt the smooth flow of work. These problems and potential solutions were elaborated on in Chapter 7, which deals with the design of work systems.

In spite of the built-in attributes of flow systems related to scheduling, a number of scheduling problems remain. One stems from the fact that few flow systems are *completely* devoted to a single product or service; most must handle a variety of sizes and models. Thus, an automobile manufacturer will assemble many different combinations of cars—two-door and four-door models, some with air-conditioning and some not, some with deluxe trim and others with standard trim, some with CD players, some with tinted glass, and so on. The same can be said for producers of appliances, electronic equipment, and toys. Each change involves slightly different inputs of parts, materials, and processing requirements that must be scheduled into the line. If the line is to operate smoothly, a supervisor must coordinate the flow of materials and the work, which includes the inputs, processing, and outputs, as well as purchases. In addition to achieving a smooth flow, it is important to avoid excessive buildup of inventories. Again, each variation in size or model will tend to have somewhat different inventory requirements, so that additional scheduling efforts will be needed.

One source of scheduling concern is possible disruptions in the system that result in less than the desired output. These can be caused by equipment failures, material shortages, accidents, and absences. In practice, it is usually impossible to increase the rate of output to compensate for these factors, mainly because flow systems are designed to operate at a given rate. Instead, strategies involving subcontracting or overtime are often

Flow system High-volume system in which jobs all follow the same sequence.

Flow-shop scheduling
Scheduling for flow systems.

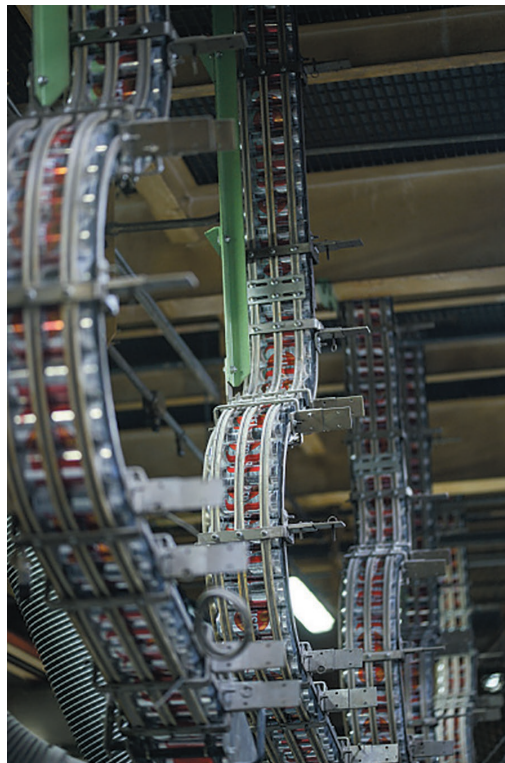

Aluminium cans travel along the production line after being washed at a beverage plant in Brazil.

required, although subcontracting on short notice is not always feasible. Sometimes work that is partly completed can be made up off the line.

The reverse situation can also impose scheduling problems, although these are less severe. This happens when the desired output is less than the usual rate. However, instead of slowing the ensuing rate of output, it is usually necessary to operate the system at the usual rate, but for fewer hours. For instance, a production line might operate temporarily for seven hours a day instead of eight.

High-volume systems usually require automated or specialized equipment for processing and handling. Moreover, they perform best with a high, uniform output. Shutdowns and start-ups are generally costly, and especially costly in process industries. Consequently, the following factors often determine the success of such a system:

- **Process and product design.** Here, cost and manufacturability are important, as is achieving a smooth flow through the system.
- **Preventive maintenance.** Keeping equipment in good operating order can minimize breakdowns that would disrupt the flow of work.
- **Rapid repair when breakdowns occur.** This can require specialists, as well as stocks of critical spare parts.
- **Optimal product mixes.** Techniques such as linear programming can be used to determine optimal blends of inputs to achieve desired outputs at minimal costs. This is particularly true in the manufacture of fertilizers, animal feeds, and diet foods.
- **Minimization of quality problems.** Quality problems can be extremely disruptive, requiring shutdowns while problems are resolved. Moreover, when output fails to meet quality standards, not only is there the loss of output but also a waste of the labor, material, time, and other resources that went into it.
- **Reliability and timing of supplies.** Shortages of supplies are an obvious source of disruption and must be avoided. On the other hand, if the solution is to stockpile supplies, that can lead to high carrying costs. Shortening supply lead times, developing reliable supply schedules, and carefully projecting needs are all useful.

LO16.4 Describe scheduling needs in intermediate-volume systems.

Scheduling in Intermediate-Volume Systems

Intermediate-volume system outputs fall between the standardized type of output of the high-volume systems and made-to-order output of job shops. Like the high-volume systems, intermediate-volume systems typically produce standard outputs. If manufacturing is involved, the products may be for stock rather than for special order. However, the volume of output in such cases is not large enough to justify continuous production. Instead, it is more economical to process these items *intermittently*. Thus, intermediate-volume work centers periodically shift from one job to another. In contrast to a job shop, the run (batch) sizes are relatively large. Examples of products made in these systems include canned foods, baked goods, paint, and cosmetics.

The three basic issues in these systems are the *run size* of jobs, the *timing* of jobs, and the *sequence* in which jobs should be processed.

Sometimes, the issue of run size can be determined by using a model such as the economic run size model discussed in Chapter 12 on inventory management. The run size that would minimize setup and inventory costs is

$$Q_p = \sqrt{\frac{2DS}{H}} \sqrt{\frac{p}{p-u}}, \text{ where } S = \text{Setup cost rather than ordering cost} \quad (16-1)$$

Setup cost may be an important consideration. Setup costs may depend on the order in which jobs are processed; similar jobs may require less setup change between them. For example, jobs in a print shop may be sequenced by ink color to reduce the number of setups needed. This opens up the possibility of reducing setup cost and time by taking processing sequence into account. It also makes sequencing more complex, and it requires estimating job setup costs for every sequence combination.

In another vein, companies are working to reduce setup times and, hence, experience less downtime for equipment changeover. Tactics include offline setups, snap-on parts, modular setups, and flexible equipment designed to handle a variety of processing requirements.

Another difficulty arises because usage is not always as smooth as assumed in the model. Some products will tend to be used up faster than expected and have to be replenished sooner. Also, because multiple products are to be processed, it is not always possible to schedule production to correspond with optimum run times.

Another approach frequently used is to base production on a master schedule developed from customer orders and forecasts of demand. Companies engaged in assembly operations would then use an MRP approach (described in Chapter 13) to determine the quantity and projected timing of jobs for components. The manager would then compare projected requirements with projected capacity and develop a feasible schedule from that information. Companies engaged in producing processed rather than assembled goods (e.g., food products, such as canned goods and beverages; publishing, such as magazines; paints and cleaning supplies) would use a somewhat different approach; the *time-phasing* information provided by MRP would not be an important factor.

16.2 SCHEDULING IN LOW-VOLUME SYSTEMS

The characteristics of low-volume systems (job shops) are considerably different from those of high- and intermediate-volume systems. Recall that job shops include hospital emergency rooms, repair shops, tool and die shops, and the like. Products are made to order, and services are performed according to need. Orders usually differ considerably in terms of processing requirements, materials needed, processing time, and processing sequence and setups. Because of these circumstances, **job-shop scheduling** can sometimes be fairly complex. This is compounded by the impossibility of establishing firm schedules prior to receiving the actual jobs.

Job-shop processing gives rise to two important issues for schedulers: how to distribute the workload among work centers and what job processing sequence to use.

Loading

Loading refers to the assignment of jobs to processing (work) centers. Loading decisions involve assigning specific jobs to work centers and to various machines in the work centers. In cases where a job can be processed only by a specific center, loading presents little difficulty. However, problems arise when two or more jobs are to be processed and there are a number of work centers capable of performing the required work. In such cases, the operations manager needs some way of assigning jobs to the centers.

When making assignments, managers often seek an arrangement that will minimize processing and setup costs, minimize idle time among work centers, or minimize job completion time, depending on the situation.

Gantt Charts. Visual aids called **Gantt charts** are used for a variety of purposes related to loading and scheduling. They derive their name from Henry Gantt, who pioneered the use of charts for industrial scheduling in the early 1900s. Gantt charts can be used in a number of different ways, two of which are illustrated in Figure 16.2, which shows scheduling classrooms for a university and scheduling hospital operating rooms for a day.

The purpose of Gantt charts is to organize and visually display the actual or intended use of resources in a *time framework*. In most cases, a time scale is represented horizontally, and resources to be scheduled are listed vertically. The use and idle times of resources are reflected in the chart.

Managers may use the charts for trial-and-error schedule development to get an idea of what different arrangements would involve. Thus, a tentative surgery schedule might reveal insufficient allowance for surgery that takes longer than expected and can be revised accordingly. Use of the chart for classroom scheduling would help avoid assigning two different classes to the same room at the same time.

There are a number of different types of Gantt charts. Two of the most commonly used are the *load chart* and the *schedule chart*.

LO16.5 Describe scheduling needs in job shops.

Job-shop scheduling Scheduling for low-volume systems with many variations in requirements.

Loading The assignment of jobs to processing centers.

Gantt chart Chart used as a visual aid for loading and scheduling purposes.

LO16.6 Use and interpret Gantt charts.

FIGURE 16.2
Examples of charts used for scheduling

Classroom schedule: Fall Friday

Room	8	9	10	11	12	1	2	3	4	5
A100	Stat 1	Econ 101	Econ 102	Fin 201	Mar 210	Acct 212				Mar 410
A105	Stat 2	Math 2a	Math 2b			Acct 210	CCE	---	---	---
A110	Acct 340	Mgmt 250	Math 3		Mar 220					
A115	Mar 440		Mgmt 230			Fin 310	Acct 360			

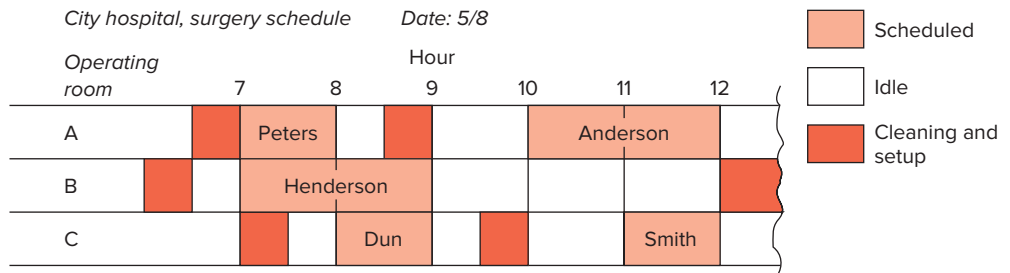

Load chart A Gantt chart that shows the loading and idle times for a group of machines or list of departments.

A **load chart** depicts the loading and idle times for a group of machines or a list of departments. Figure 16.3 illustrates a typical load chart. This chart indicates that work center 3 is completely loaded for the entire week, center 4 will be available from Tuesday to Friday, and the other two centers have idle time scattered throughout the week. This information can help a manager rework loading assignments to better utilize the centers. For instance, if all centers perform the same kind of work, the manager might want to free one center for a long job or a rush order. The chart also shows when certain jobs are scheduled to start and finish, and where to expect idle time.

Infinite loading Jobs are assigned to work centers without regard to the capacity of the work center.

Two different approaches are used to load work centers: *infinite* loading and *finite* loading. **Infinite loading** assigns jobs to work centers without regard to the capacity of the work center. As you can see in the diagram that follows, this can lead to overloads in some time periods and underloads in others. The priority sequencing rules described in this chapter use infinite loading. One possible result of infinite loading is the formation of queues in some (or all) work centers. That requires a second step to correct the imbalance. **Finite loading** projects actual job starting and stopping times at each work center, taking into account the capacities of each work center and the processing times of jobs, so that capacity is not exceeded. One output of finite loading is a detailed projection of hours each work center will operate. Schedules based on finite loading may have to be updated often, perhaps daily, due to processing delays at work centers and the addition of new jobs or cancellation of current jobs. The following diagram illustrates these two approaches.

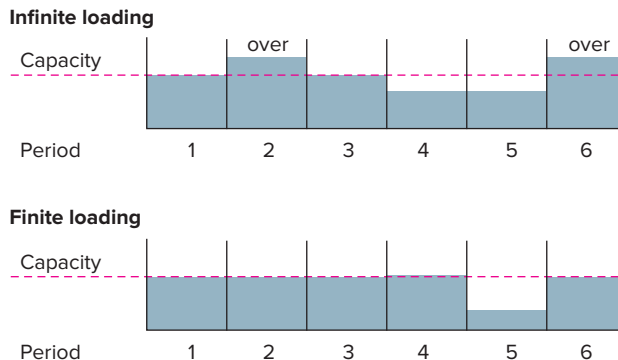

Finite loading Jobs are assigned to work centers taking into account the work center capacity and job processing times.

A.

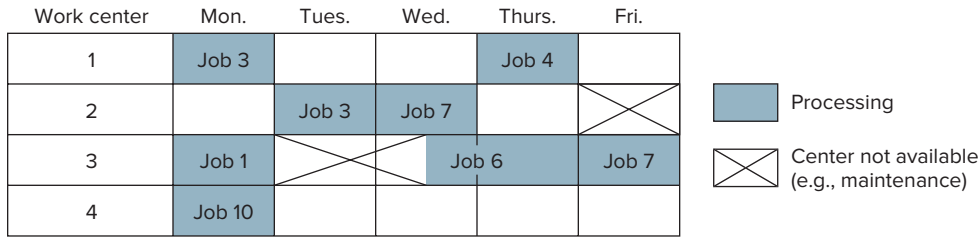
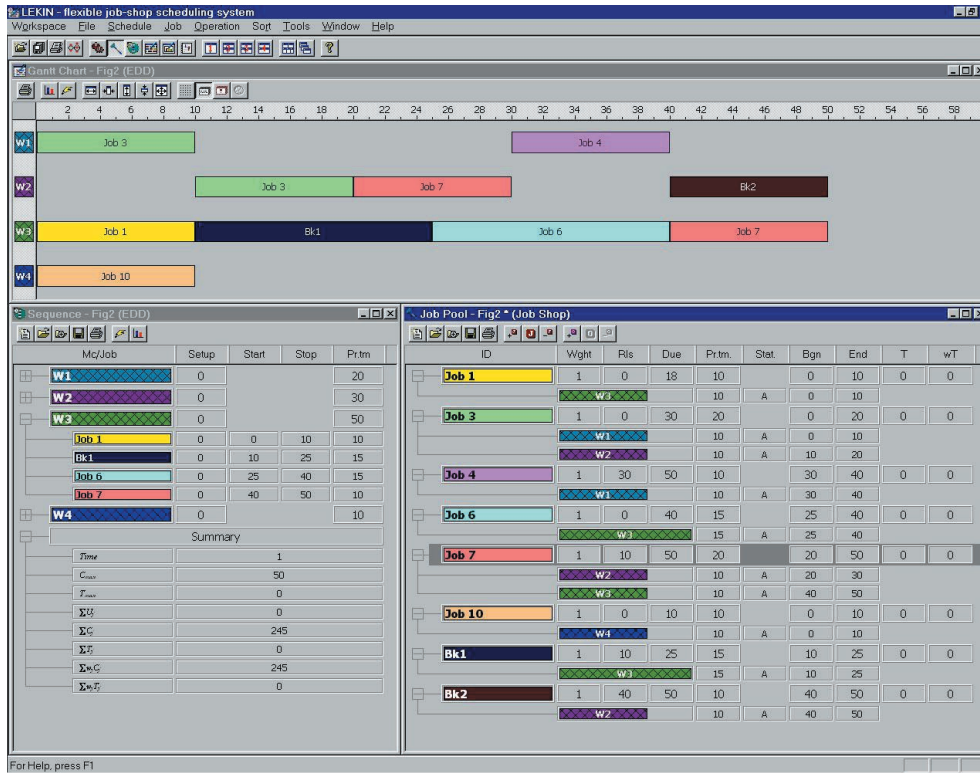

FIGURE 16.3

A. Sample Gantt load chart.
 B. The same Gantt chart using the Lekin software, developed at New York University, includes multiple scheduling routines along with graphics.

Source: Pinedo and Feldman

B.



With infinite loading, a manager may need to make some response to overloaded work centers. Among the possible responses are shifting work to other periods or other centers, working overtime, or contracting out a portion of the work. Note that the last two options in effect increase capacity to meet the workload.

Finite loading may reflect a fixed upper limit on capacity. For example, a bus line will have only so many buses. Hence, the decision to place into service a particular number of buses fixes capacity. Similarly, a manufacturer might have one specialized machine that it operates around the clock. Thus, it is operated at the upper limit of its capacity, so finite loading would be called for.

There are two general approaches to scheduling—forward scheduling and backward scheduling. **Forward scheduling** means scheduling ahead from a point in time; **backward scheduling** means scheduling backward from a job’s due date. Forward scheduling is used if the issue is “How long will it take to complete this job?” Backward scheduling would be used if the issue is “When is the latest the job can be started and still be completed by the due date?” Forward scheduling enables the scheduler to determine the earliest possible completion time for each job and, thus, the amount of lateness or the amount of slack can be determined. That information can be combined with information from other jobs in setting up a schedule for all current jobs.

Forward scheduling Scheduling ahead from a point in time.

Backward scheduling Scheduling backward from a due date.

Schedule chart A Gantt chart that shows the orders or jobs in progress and whether they are on schedule.

A manager often uses a **schedule chart** to monitor the progress of jobs. The vertical axis on this type of Gantt chart shows the orders or jobs in progress, and the horizontal axis shows time. The chart indicates which jobs are on schedule and which are behind or ahead.

A typical schedule chart is illustrated in Figure 16.4. It shows the current status of a landscaping job with planned and actual starting and finishing times for the five stages of the job. The chart indicates that approval and the ordering of trees and shrubs was on schedule. The site preparation was a bit behind schedule. The trees were received earlier than expected, and planting is ahead of schedule. However, the shrubs have not yet been received. The chart indicates some slack between scheduled receipt of shrubs and shrub planting, so if the shrubs arrive by the end of the week, it appears the schedule can still be met.

Despite the obvious benefits of Gantt charts and the fact that they are widely used, they possess certain limitations, the chief one being the need to repeatedly update a chart to keep it current. In addition, a chart does not directly reveal costs associated with alternative loadings. Finally, a job’s processing time may vary depending on the work center; certain stations or work centers may be capable of processing some jobs faster than other stations. Again, that situation would increase the complexity of evaluating alternative schedules.

In addition to Gantt charts, managers often rely on input/output reports to manage work flow.

Input/output (I/O) control Managing work flow and queues at work centers.

Input/Output Control. **Input/output (I/O) control** refers to monitoring the work flow and queue lengths at work centers. The purpose of I/O control is to manage work flow so that queues and waiting times are kept under control. Without I/O control, demand may exceed processing capacity, causing an overload at a center. Conversely, work may arrive slower than the rate a work center can handle, leaving the work center underutilized. Ideally, a balance can be struck between the input and output rates, thereby achieving effective use of work center capacities without experiencing excessive queues at the work centers. A simple example of I/O control is the use of stoplights on some expressway on-ramps. These regulate the flow of entering traffic according to the current volume of expressway traffic.

Figure 16.5 illustrates an input/output report for a work center. A key portion of the report is the backlog of work waiting to be processed. The report also reveals deviations-from-planned for both inputs and outputs, thereby enabling a manager to determine possible sources of problems.

The deviations in each period are determined by subtracting “planned” from “actual.” For example, in the first period, subtracting the planned input of 100 hours from the actual input of 120 hours produces a deviation of +20 hours. Similarly, in the first period, the planned and actual outputs are equal, producing a deviation of 0 hours.

The backlog for each period is determined by subtracting the “actual output” from the “actual input” and adjusting the backlog from the previous period by that amount. For example, in the second period, actual output exceeds actual input by 10 hours. Hence, the previous backlog of 50 hours is reduced by 10 hours to 40 hours.

Another approach that can be used to assign jobs to resources is the *assignment method*.

FIGURE 16.4 Progress chart for landscaping job

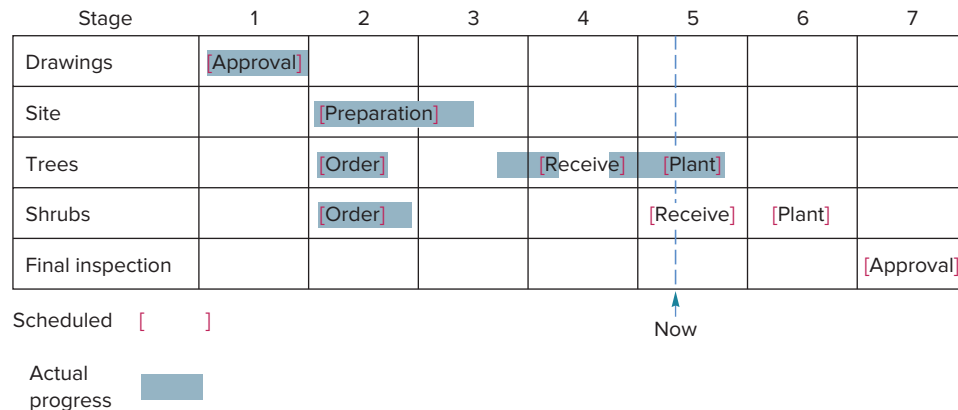

		Period					
		1	2	3	4	5	6
Input	Planned	100	100	90	90	90	90
	Actual	120	95	80	88	93	94
	Deviation	+20	-5	-10	-2	+3	+4
	Cum. dev.	+20	+15	+5	+3	+6	+10
Output	Planned	110	110	100	100	100	95
	Actual	110	105	95	101	103	96
	Deviation	0	-5	-5	+1	+3	+1
	Cum. dev.	0	+5	+10	+9	+6	+5
Backlog	40*	50	40	25	12	2	0

FIGURE 16.5

A sample input/output report for a work center showing input and output in hours of processing time

Note: Figures represent standard hours of processing time.

*Given, not derived from the data.

Assignment Method of Linear Programming. The **assignment model** is a special-purpose linear programming model that is useful in situations that call for assigning tasks or other work requirements to resources. Typical examples include assigning jobs to machines or workers, territories to salespeople, and repair jobs to repair crews. The idea is to obtain an optimum *matching* of tasks and resources. Commonly used criteria include costs, profits, efficiency, and performance.

Table 16.1 illustrates a typical problem, where four jobs are to be assigned to four workers. The problem is arranged in a format that facilitates evaluation of assignments. The numbers in the body of the table represent the value or cost associated with each job-worker combination. In this case, the numbers represent costs. Thus, it would cost \$8 for worker A to do job 1, \$6 for worker B to do job 1, and so on. If the problem involved minimizing the cost for job 1 alone, it would clearly be assigned to worker C, because that combination has the lowest cost. However, that assignment does not take into account the other jobs and their costs, which is important because the lowest-cost assignment for any one job may not be consistent with a minimum-cost assignment when all jobs are considered.

If there are to be n matches, there are $n!$ different possibilities. In this case, there are $4! = 24$ different matches. One approach is to investigate each match and select the one with the lowest cost. However, if there are 12 jobs, there would be 479 million different matches! A much simpler approach is to use a procedure called the **Hungarian method** to identify the lowest-cost solution.

To be able to use the Hungarian method, a one-for-one matching is required. Each job, for example, must be assigned to only one worker. It is also assumed that every worker is capable of handling every job, and that the costs or values associated with each assignment combination are known and fixed (i.e., not subject to variation). The number of rows and columns must be the same. Solved Problem 1 at the end of the chapter shows what to do if they aren't the same.

Once the relevant cost information has been acquired and arranged in tabular form, the basic procedure of the Hungarian method is as follows:

1. Subtract the smallest number in each row from every number in the row. This is called a *row reduction*. Enter the results in a new table.
2. Subtract the smallest number in each column of the new table from every number in the column. This is called a *column reduction*. Enter the results in another table.
3. Test whether an optimum assignment can be made. You do this by determining the *minimum* number of lines (horizontal or vertical) needed to cross out (cover) all zeroes. If the number of lines equals the number of rows, an optimum assignment is possible. In that case, go to step 6. Otherwise, go on to step 4.

Assignment model A linear programming model for optimal assignment of tasks and resources.

LO16.7 Use the assignment method for loading.

Hungarian method Method of assigning jobs by a one-for-one matching to identify the lowest-cost solution.

TABLE 16.1

A typical assignment problem showing job times for each job/worker combination

		WORKER			
		A	B	C	D
Job	1	8	6	2	4
	2	6	7	11	10
	3	3	5	7	6
	4	5	10	12	9

4. If the number of lines is less than the number of rows, modify the table in this way:
 - a. Subtract the smallest uncovered number from every uncovered number in the table.
 - b. Add the smallest uncovered number to the numbers at *intersections* of cross-out lines.
 - c. Numbers crossed out but not at intersections of cross-out lines carry over to the next table.
5. Repeat steps 3 and 4 until an optimal table is obtained.
6. Make the assignments. Begin with rows or columns with only one zero. Match items that have zeroes, using only one match for each row and each column. Eliminate both the row and the column after the match.

EXAMPLE 1**Using the Assignment Method to Make Job Assignments****excel**

mhhe.com/stevenson14e

Determine the optimum assignment of jobs to workers for the following data (from Table 16.1):

		WORKER				Row Minimum
		A	B	C	D	
Job	1	8	6	2	4	2
	2	6	7	11	10	6
	3	3	5	7	6	3
	4	5	10	12	9	5

SOLUTION

- a. Subtract the smallest number in each row from every number in the row, and enter the results in a new table. The result of this row reduction is:

		WORKER			
		A	B	C	D
Job	1	6	4	0	2
	2	0	1	5	4
	3	0	2	4	3
	4	0	5	7	4
Column Minimum		0	1	0	2

- b. Subtract the smallest number in each column from every number in the column, and enter the results in a new table. The result of this column reduction is:

		WORKER			
		A	B	C	D
Job	1	6	3	0	0
	2	0	0	5	2
	3	0	1	4	1
	4	0	4	7	2

- c. Determine the *minimum* number of lines needed to cross out all zeroes. (Try to cross out as many zeroes as possible when drawing lines.)

		WORKER			
		A	B	C	D
Job	1	6	3	0	0
	2	0	0	5	2
	3	0	1	4	1
	4	0	4	7	2

- d. Because only three lines are needed to cross out all zeroes and the table has four rows, this is not the optimum. Note that the smallest uncovered value is 1.

- e. Subtract the smallest uncovered value from every uncovered number that hasn't been crossed out, and add it to numbers that are at the intersections of covering lines. The results are as follows:

		WORKER			
		A	B	C	D
Job	1	7	3	0	0
	2	1	0	5	2
	3	0	0	3	0
	4	0	3	6	1

- f. Determine the minimum number of lines needed to cross out all zeroes (four). Because this equals the number of rows, you can make the optimum assignment.

		WORKER			
		A	B	C	D
Job	1	7	3	0	0
	2	1	0	5	2
	3	0	0	3	0
	4	0	3	6	1

- g. Make assignments: Start with rows and columns with only one zero. Match jobs with machines that have a zero cost.

		WORKER				Assignment	Cost
		A	B	C	D		
Job	1	7	3	0	0	1-C	\$ 2
	2	1	0	5	2	2-B	7
	3	0	0	3	0	3-D	6
	4	0	3	6	1	4-A	5
							<u>20</u>

The assignment problem can also be solved using an Excel template, as seen in Table 16.2. The ones in the solution matrix denote assignments (i.e., assign C to job 1), and the zeroes denote no assignment for a worker/machine and job combination.

TABLE 16.2 Excel solution to Example 1

Input Matrix:		Worker/Machine									
		A	B	C	D	E	F	G	H		
Job	1	8	6	2	4					1	
	2	6	7	11	10					1	
	3	3	5	7	6					1	
	4	5	10	12	9					1	
	5										0
	6										0
	7										0
	8										0
		1	1	1	1	0	0	0	0		
										Total Jobs = 4	
										Total Workers/Machines = 4	
Solution Matrix:		Worker/Machine									
		A	B	C	D	E	F	G	H		
Job	1	0	0	1	0	0	0	0	0	1	
	2	0	1	0	0	0	0	0	0	1	
	3	0	0	0	1	0	0	0	0	1	
	4	1	0	0	0	0	0	0	0	1	
	5	0	0	0	0	0	0	0	0	0	
	6	0	0	0	0	0	0	0	0	0	
	7	0	0	0	0	0	0	0	0	0	
	8	0	0	0	0	0	0	0	0	0	
		1	1	1	1	0	0	0	0		
										Total Cost = 20	

Source: Microsoft

As you can see, the process is relatively simple. The simplicity of the Hungarian method belies its usefulness when the assumptions are met. Not only does it provide a rational method for making assignments, it guarantees an optimal solution, often without the use of a computer, which is necessary only for fairly large problems. When profits instead of costs are involved, the profits can be converted to *relative costs* by subtracting every number in the table from the largest number and then proceeding as in a minimization problem.

It is worth knowing that one extension of this technique can be used to prevent undesirable assignments. For example, union rules may prohibit one person's assignment to a particular job, or a manager might wish to avoid assigning an unqualified person to a job. Whatever the reason, specific combinations can be avoided by assigning a relatively high cost to that combination. In the previous example, if we wish to avoid combination 1-A, assigning a cost of \$50 to that combination will achieve the desired effect, because \$50 is much greater than the other costs.

Sequencing

Although loading decisions determine the machines or work centers that will be used to process specific jobs, they do not indicate the *order* in which the jobs waiting at a given work center are to be processed. **Sequencing** is concerned with determining job processing order. Sequencing decisions determine both the order in which jobs are processed at various work centers and the order in which jobs are processed at individual **workstations** *within* the work centers.

If work centers are lightly loaded and if jobs all require the same amount of processing time, sequencing presents no particular difficulties. However, for heavily loaded work centers, especially in situations where relatively lengthy jobs are involved, the order of processing can be very important in terms of costs associated with jobs waiting for processing and in terms of idle time at the work centers. In this section, we will examine some of the ways in which jobs are sequenced.

Typically, a number of jobs will be waiting for processing. **Priority rules** are simple heuristics used to select the order in which the jobs will be processed. Some of the most common are listed in Table 16.3. The rules generally rest on the assumption that job setup cost and time are *independent* of processing sequence. In using these rules, job processing times and due dates are important pieces of information. **Job time** usually includes setup and processing times. Jobs that require similar setups can lead to reduced setup times if the sequencing rule takes this into account (the rules described here do not). Due dates may be the result of delivery times promised to customers, material requirements planning (MRP) processing, or managerial decisions. They are subject to revision and must be kept current to give meaning to sequencing choices. Also, it should be noted that due dates associated with all rules except slack per operation (S/O) and critical ratio (CR) are for the operation about to be performed; due dates for S/O and CR are typically final due dates for orders rather than intermediate, departmental deadlines.

The priority rules can be classified as either *local* or *global*. **Local priority rules** take into account information pertaining only to a single workstation; **global priority rules** take into account information pertaining to multiple workstations. First come, first served (FCFS), shortest processing time (SPT), and earliest due date (EDD) are local rules; CR and S/O are global rules. Rush can be either local or global. As you might imagine, global rules require more effort than local rules. A major complication in global sequencing is that not all jobs require

Sequencing Determining the order in which jobs at a work center will be processed.

Workstation An area where one or a few workers and/or machines perform similar work.

Priority rules Simple heuristics used to select the order in which jobs will be processed.

Job time Time needed for the setup and processing of a job.

Local priority rules Focus on information pertaining to a single workstation when establishing a job sequence.

Global priority rules Incorporate information from multiple workstations when establishing a job sequence.

TABLE 16.3

Possible priority rules

LO16.8 Give examples of commonly used priority rules.

First come, first served (FCFS): Jobs are processed in the order in which they arrive at a machine or work center.

Shortest processing time (SPT): Jobs are processed according to processing time at a machine or work center, shortest job first.

Earliest due date (EDD): Jobs are processed according to due date, earliest due date first.

Critical ratio (CR): Jobs are processed according to smallest ratio of time remaining until due date to processing time remaining.

Slack per operation (S/O): Jobs are processed according to average slack time (time until due date minus remaining time to process). Compute by dividing slack time by number of remaining operations, including the current one.

Rush: Emergency or preferred customers first.

The set of jobs is known; no new jobs arrive after processing begins; and no jobs are canceled.
 Setup time is independent of processing sequence.
 Setup time is deterministic.
 Processing times are deterministic rather than variable.
 There will be no interruptions in processing such as machine breakdowns, accidents, or worker illness.

the same processing or even the same order of processing. As a result, the set of jobs is different for different workstations. Local rules are particularly useful for bottleneck operations, but they are not limited to those situations.

A number of assumptions apply when using the priority rules; Table 16.4 lists them. In effect, the priority rules pertain to *static* sequencing: For simplicity, it is assumed there is no variability in either setup or processing times, or in the set of jobs. The assumptions make the scheduling problem manageable. In practice, jobs may be delayed or canceled, and new jobs may arrive, requiring schedule revisions.

The effectiveness of any given sequence is frequently judged in terms of one or more *performance measures*. The most frequently used performance measures follow:

- **Job flow time** is the amount of time it takes from when a job arrives until it is complete. It includes not only actual processing time but also any time waiting to be processed, transportation time between operations, and any waiting time related to equipment breakdowns, unavailable parts, quality problems, and so on. The average flow time for a group of jobs is equal to the total flow time for the jobs divided by the number of jobs. Flow time is the *cumulative* sum of job times. It is a job's time plus the sum of all preceding job times. Total flow time is equal to the sum of the cumulative job flow times. For example, if there are three jobs, each with a time of 10 minutes, the flow time of the first job is 10 minutes, the flow time of the second job is $10 + 10 = 20$ minutes, and the flow time of the third job is $20 + 10 = 30$ minutes. The total flow time for the three jobs is then $10 + 20 + 30 = 60$ minutes.
- **Job lateness** is the amount of time the job completion date is expected to exceed the date the job was due or promised to a customer. It is the difference between the actual completion time and the due date. If only differences for jobs with completion times that exceed due dates are recorded, and zeroes are assigned to jobs that are early, the term used is job *tardiness*.
- **Makespan** is the total time needed to complete a *group* of jobs. It is the length of time between the start of the first job in the group and the completion of the last job in the group. If processing involves only one work center, makespan will be the same regardless of the priority rule being used.
- **Average number of jobs.** Jobs that are in a shop are considered to be work-in-process inventory. The average work-in-process for a group of jobs can be computed using the following formula:

$$\text{Average number of jobs} = \text{Total flow time} \div \text{Makespan}$$

If the jobs represent equal amounts of inventory, the average number of jobs will also reflect the average work-in-process inventory.

Of the priority rules, rush scheduling is quite simple and needs no explanation. The other rules and performance measures are illustrated in the following two examples.

TABLE 16.4
 Assumptions of priority rules

Job flow time The amount of time from when a job arrives until it is finished.

Job lateness The difference between the actual completion date and the due date.

Makespan Total time needed to complete a group of jobs from the beginning of the first job to the completion of the last job.

Determining Job Sequences Using Various Rules

Processing times (including setup times) and due dates for six jobs waiting to be processed at a work center are given in the following table. Determine the sequence of jobs, the average flow time, average tardiness, and average number of jobs at the work center, for each of these rules:

- FCFS
- SPT

EXAMPLE 2

excel
 mhhe.com/stevenson14e

- c. EDD
d. CR

Job	Processing Time (days)	Due Date (days from present time)
A	2	7
B	8	16
C	4	4
D	10	17
E	5	15
F	12	18

Assume jobs arrived in the order shown.

SOLUTION

- a. The FCFS sequence is simply A-B-C-D-E-F. The measures of effectiveness are as follows (see table):

(1) *Average flow time*: $120/6 = 20$ days

(2) *Average tardiness*: $54/6 = 9$ days

(3) The *makespan* is 41 days. *Average number of jobs at the work center*: $120/41 = 2.93$

Job Sequence	(1) Processing Time	(2) Flow Time	(3) Due Date	(2) - (3) Days Tardy [0 if negative]
A	2	2	7	0
B	8	10	16	0
C	4	14	4	10
D	10	24	17	7
E	5	29	15	14
F	<u>12</u>	<u>41</u>	18	<u>23</u>
	41	120		54

The flow time column indicates *cumulative* processing time, so summing these times and dividing by the total number of jobs processed indicates the average time each job spends at the work center. Similarly, find the average number of jobs at the center by summing the flow times and dividing by the total processing time.

The Excel solution is shown in Table 16.5.

- b. Using the SPT rule, the job sequence is A-C-E-B-D-F (see the following table). The resulting values for the three measures of effectiveness are:

(1) *Average flow time*: $108/6 = 18$ days

(2) *Average tardiness*: $40/6 = 6.67$ days

(3) *Average number of jobs at the work center*: $108/41 = 2.63$

Job Sequence	(1) Processing Time	(2) Flow Time	(3) Due Date	(2) - (3) Days Tardy [0 if negative]
A	2	2	7	0
C	4	6	4	2
E	5	11	15	0
B	8	19	16	3
D	10	29	17	12
F	<u>12</u>	<u>41</u>	18	<u>23</u>
	41	108		40

TABLE 16.5 Excel solution for Example 2a

Job Sequencing									
<Back	Notes	Clear	FCFS	SPT	DD	CR	S/O		
Current Date:				23					
Job	Process. Time	Due Date	Remain Oper.	CR Sequence	Critical Ratio	Slack	S/O	Flow Time	Days Late
A	2	7		3		5		2	0
B	8	16		5		8		10	0
C	4	4		1		0		14	10
D	10	17		6		7		24	7
E	5	15		4		10		29	14
F	12	18		2		6		41	23
Totals	41		0			36		120	54

Method	FCFS
Average Flow Time	20.00
Average Tardiness	9.00
Average Number of Jobs	2.93

See notes below.

Notes:

- Enter Job Name, Processing Time, and Due Date for each job.
- For the FCFS, SPT, and DD rules, simply press the appropriate button.
- For the CR rule, perform the following BEFORE pressing the CR button:
 - Select job with lowest Critical Ratio
 - Schedule that job next by entering next sequence number (start with 1) in the CR Sequence column.
 - Add the processing time for that job to the current date.
 - Repeat steps a, b, and c until all jobs have been scheduled (i.e. the CR Sequence column is filled in).
 - Then press the CR button.
- Fill in the Remaining Operations column and then press the S/O button.

Source: Microsoft

- c. Using earliest due date as the selection criterion, the job sequence is C-A-E-B-D-F. The measures of effectiveness are as follows (see table):
- (1) Average flow time: $110/6 = 18.33$ days
 - (2) Average tardiness: $38/6 = 6.33$ days
 - (3) Average number of jobs at the work center: $110/41 = 2.68$

Job Sequence	(1) Processing Time	(2) Flow Time	(3) Due Date	(2) - (3) Days Tardy [0 if negative]
C	4	4	4	0
A	2	6	7	0
E	5	11	15	0
B	8	19	16	3
D	10	29	17	12
F	12	41	18	23
	41	110		38

d. Using the critical ratio, we find:

Job Sequence	Processing Time	Due Date	Critical Ratio Calculation
A	2	7	$(7 - 0)/2 = 3.5$
B	8	16	$(16 - 0)/8 = 2.0$
C	4	4	$(4 - 0)/4 = 1.0$ (lowest)
D	10	17	$(17 - 0)/10 = 1.7$
E	5	15	$(15 - 0)/5 = 3.0$
F	12	18	$(18 - 0)/12 = 1.5$

At day 4 [C completed], the critical ratios are:

Job Sequence	Processing Time	Due Date	Critical Ratio Calculation
A	2	7	$(7 - 4)/2 = 1.5$
B	8	16	$(16 - 4)/8 = 1.5$
C	—	—	—
D	10	17	$(17 - 4)/10 = 1.3$
E	5	15	$(15 - 4)/5 = 2.2$
F	12	18	$(18 - 4)/12 = 1.17$ (lowest)

At day 16 [C and F completed], the critical ratios are:

Job Sequence	Processing Time	Due Date	Critical Ratio Calculation
A	2	7	$(7 - 16)/2 = -4.5$ (lowest)
B	8	16	$(16 - 18)/8 = 0.0$
C	—	—	—
D	10	17	$(17 - 16)/10 = 0.1$
E	5	15	$(15 - 16)/5 = -0.2$
F	—	—	—

At day 18 [C, F, and A completed], the critical ratios are:

Job Sequence	Processing Time	Due Date	Critical Ratio Calculation
A	—	—	—
B	8	16	$(16 - 18)/8 = -0.25$
C	—	—	—
D	10	17	$(17 - 18)/10 = -0.10$
E	5	15	$(15 - 18)/5 = -0.60$ (lowest)
F	—	—	—

At day 23 [C, F, A, and E completed], the critical ratios are:

Job Sequence	Processing Time	Due Date	Critical Ratio Calculation
A	—	—	—
B	8	16	$(16 - 23)/8 = -0.875$ (lowest)
C	—	—	—
D	10	17	$(17 - 23)/10 = -0.60$
E	—	—	—
F	—	—	—

The job sequence is C-F-A-E-B-D, and the resulting values for the measures of effectiveness are as follows:

- (1) *Average flow time:* $133/6 = 22.17$ days
- (2) *Average tardiness:* $58/6 = 9.67$ days
- (3) *Average number of jobs at the work center:* $133/41 = 3.24$

Sequence	(1) Processing Time	(2) Flow Time	(3) Due Date	(2) – (3) Days Tardy
C	4	4	4	0
F	12	16	18	0
A	2	18	7	11
E	5	23	15	8
B	8	31	16	15
D	10	41	17	24
	41	133		58

The results of these four rules are summarized in Table 16.6.

In Example 2, the SPT rule was the best according to two of the measures of effectiveness and a little worse than the EDD rule on average tardiness. The CR rule was the worst in every case. For a different set of numbers, the EDD rule (or perhaps another rule not mentioned here) might prove superior to SPT in terms of average job tardiness or some other measure of effectiveness. However, SPT is always superior in terms of minimizing flow time and, hence, in terms of minimizing the average number of jobs at the work center and completion time. This results in faster job completion, which has the potential to generate more revenue.

Generally speaking, the FCFS rule and the CR rule turn out to be the least effective of the rules.

The primary limitation of the FCFS rule is that long jobs will tend to delay other jobs. If a process consists of work on a number of machines, machine idle time for downstream workstations will increase. However, for service systems in which customers are directly involved, the FCFS rule is by far the dominant priority rule, mainly because of the inherent fairness, but also because of the inability to obtain realistic estimates of processing time for individual jobs. The FCFS rule also has the advantage of simplicity. If other measures are important when there is high customer contact, companies may adopt the strategy of moving processing to the “backroom” so they don’t necessarily have to follow FCFS.

Because the SPT rule always results in the lowest (i.e., optimal) average completion (flow) time, it can result in lower in-process inventories. And because it often provides the lowest (optimal) average tardiness, it can result in better customer service levels. Finally, because it always involves a lower average number of jobs at the work center, there tends to be less congestion in the work area. SPT also minimizes downstream idle time. However, due dates are often uppermost in managers’ minds, so they may not use SPT because it doesn’t incorporate due dates.

The major disadvantage of the SPT rule is that it tends to make long jobs wait, perhaps for rather long times (especially if new, shorter jobs are continually added to the system). That can be troubling if long jobs are from the company’s best customers. Various modifications may be used in an effort to avoid this. For example, after waiting for a given time period, any remaining jobs are automatically moved to the head of the line. This is known as the *truncated* SPT rule.

Rule	Average Flow Time (days)	Average Tardiness (days)	Average Number of Jobs at the Work Center
FCFS	20.00	9.00	2.93
SPT	18.00	6.67	2.63
EDD	18.33	6.33	2.68
CR	22.17	9.67	3.24

TABLE 16.6

Comparison of the four rules for Example 2

The EDD rule directly addresses due dates and minimizes lateness. Although it has intuitive appeal, its main limitation is that it does not take processing time into account. One possible consequence is that it can result in some jobs waiting a long time, which adds to both in-process inventories and shop congestion.

The CR rule is easy to use and has intuitive appeal. Although it had the poorest showing in Example 2 for all three measures, it usually does quite well in terms of minimizing job tardiness. Therefore, if job tardiness is important, the CR rule might be the best choice among the rules.

Let's take a look now at the S/O (slack per operation) rule.

EXAMPLE 3

Scheduling Jobs Using the S/O Rule

eXcel

mhhe.com/stevenson14e

Use the S/O rule to schedule the following jobs. Note that processing time includes the time remaining for the current and subsequent operations. In addition, you will need to know the number of operations remaining, including the current one.

Job	Remaining Processing Time	Due Date	Remaining Number of Operations
A	4	14	3
B	16	32	6
C	8	8	5
D	20	34	2
E	10	30	4
F	18	30	2

SOLUTION

Determine the difference between the due date and the processing time for each operation. Divide the difference by the number of remaining operations, and rank them from low to high. This yields the sequence of jobs:

Job	(1) Remaining Processing Time	(2) Due Date	(3) (2) - (1) Slack	(4) Remaining Number of Operations	(5) (3) ÷ (4) Ratio	(6) Rank
A	4	14	10	3	3.33	3
B	16	32	16	6	2.67	2
C	8	8	0	5	0	1
D	20	34	14	2	7.00	6
E	10	30	20	4	5.00	4
F	18	30	12	2	6.00	5

The indicated sequence (see column 6) is C-B-A-E-F-D.

Using the S/O rule, the designated job sequence may change after any given operation, so if that happened, it would be necessary to reevaluate the sequence after each operation. Note that any of the previously mentioned priority rules could be used on a station-by-station basis for this situation; the only difference is that the S/O approach incorporates downstream information in arriving at a job sequence.

In reality, many priority rules are available to sequence jobs, and some other rule might provide superior results for a given set of circumstances. The purpose in examining these few rules is to provide insight into the nature of sequencing rules. Each shop or organization should consider carefully its own circumstances and the measures of effectiveness it feels are important, when selecting a rule to use.

The following section describes a special-purpose algorithm that can be used to sequence a set of jobs that must all be processed at the same two machines or work centers.

Sequencing Jobs through Two Work Centers¹

Johnson's rule is a technique that managers can use to minimize the makespan for a group of jobs to be processed on two machines or at two successive work centers (sometimes referred to as a two-machine flow shop).² It also minimizes the total idle time at the work centers. For the technique to work, several conditions must be satisfied:

- Job time (including setup and processing) must be known and constant for each job at each work center.
- Job times must be independent of the job sequence.
- All jobs must follow the same two-step work sequence.
- A job must be completed at the first work center before the job moves on to the second work center.

Application of Johnson's rule begins with a listing of all jobs to be scheduled, and how much time will be required by each job at each workstation. The sequence is determined by following these steps:

1. Select the job with the shortest time. If the shortest time is at the first work center, schedule that job first; if the time is at the second work center, schedule the job last. Break ties arbitrarily.
2. Eliminate the job and its time from further consideration.
3. Repeat steps 1 and 2, working toward the center of the sequence, until all jobs have been scheduled.

Successful application of these steps identifies the sequence with the minimum makespan, or when all work is completed as soon as possible. However, precisely *when* a certain job will be completed (its flow time) or when idle time will occur is not apparent by inspecting the sequence. To determine such detailed performance information, it is generally easiest to create a Gantt chart illustrating the finished sequence, as demonstrated in Example 4.

When significant idle time at the second work center occurs, job splitting at the first center just prior to the occurrence of idle time may alleviate some of it and also shorten throughput time. In Example 4, this is not a concern. The last solved problem at the end of this chapter illustrates the use of job splitting.

Johnson's rule Technique for minimizing makespan for a group of jobs to be processed on two machines or at two work centers.

Using Johnson's Rule to Sequence Jobs

A group of six jobs is to be processed through a two-machine flow shop. The first operation involves cleaning, and the second involves painting. Determine a sequence that will minimize the total completion time for this group of jobs. Processing times are as follows:

Job	PROCESSING TIME (hours)	
	Work Center 1	Work Center 2
A	5	5
B	4	3
C	8	9
D	2	7
E	6	8
F	12	15

To employ Johnson's rule, create a "blank" sequence first, such as:

1st	2nd	3rd	4th	5th	6th

EXAMPLE 4

excel
mhhe.com/stevenson14e

¹For a description of a heuristic that can be used for the case where a set of jobs is to be processed through more than two work centers, see Thomas Vollmann et al., *Manufacturing Planning and Control Systems*, 5th ed. (New York: Irwin/McGraw-Hill, 2004).

²S. M. Johnson, "Optimal Two- and Three-Stage Production with Setup Times Included," *Naval Research Quarterly* 1 (March 1954), pp. 61–68.

Thus, the group of jobs will take 51 hours to complete. The second work center will wait 2 hours for its first job and also wait 2 hours after finishing job C. Center 1 will be finished in 37 hours. Of course, idle periods at the beginning or end of the sequence could be used to do other jobs, or for maintenance or setup/teardown activities.

Sequencing Jobs When Setup Times Are Sequence-Dependent

The preceding discussion and examples assumed that machine setup times are independent of processing order, but in many instances that assumption is not true. Consequently, a manager may want to schedule jobs at a workstation taking those dependencies into account. The goal is to minimize total setup time.

Consider the following table, which shows workstation machine setup times based on job processing order. For example, if job A is followed by job B, the setup time for B will be six hours. Furthermore, if job A is completed first, followed by job B, job C will then follow job B and have a setup time of four hours. If a job is done first, its setup time will be the amount shown in the setup time column to the right of the job. Thus, if job A is done first, its setup time will be three hours.

		Setup time (hrs.)	Resulting following job setup time (hrs.) is		
			A	B	C
If the preceding job is	A	3	—	6	2
	B	2	1	—	4
	C	2	5	3	—

The simplest way to determine which sequence will result in the lowest total setup time is to list each possible sequence and determine its total setup time. In general, the number of different alternatives is equal to $n!$, where n is the number of jobs. Here, n is 3, so $n! = 3 \times 2 \times 1 = 6$. The six alternatives and their total setup times are as follows:

Sequence	Setup Times	Total
A-B-C	$3 + 6 + 4 = 13$	
A-C-B	$3 + 2 + 3 = 8$	
B-A-C	$2 + 1 + 2 = 5$ (best)	
B-C-A	$2 + 4 + 5 = 11$	
C-A-B	$2 + 5 + 6 = 13$	
C-B-A	$2 + 3 + 1 = 6$	

Hence, to minimize total setup time, the manager would select sequence B-A-C.

This procedure is relatively simple to do manually when the number of jobs is two or three. However, as the number of jobs increases, the list of alternatives quickly becomes larger. For example, six jobs would have 720 alternatives. In such instances, a manager would employ a computer to generate the list and identify the best alternative(s). (Note that more than one alternative may be tied for the lowest setup time.)

Why Scheduling Can Be Difficult

Scheduling can be difficult for a number of reasons. One is that, in reality, an operation must deal with variability in setup times, processing times, interruptions, and changes in the set of jobs. Another major reason is that, except for small job sets, there is no method



Alex Maclean/Getty Images

LO16.9 Discuss the theory of constraints and that approach to scheduling.

for identifying the optimal schedule, and it would be virtually impossible to sort through the vast number of possible alternatives to obtain the best schedule. As a result, scheduling is far from an exact science and, in many instances, is an ongoing task for a manager.

Computer technology reduces the burden of scheduling and makes real-time scheduling possible.

Minimizing Scheduling Difficulties

There are a number of actions that managers can consider to minimize scheduling problems:

- Setting realistic due dates.
- Focusing on bottleneck operations: First, try to increase the capacity of the operations. If that is not possible or feasible, schedule the bottleneck operations first, and then schedule the nonbottleneck operations around the bottleneck operations.
- Considering lot splitting for large jobs. This usually works best when there are relatively large differences in job times. Note that this doesn't apply to single-unit jobs.

The Theory of Constraints

Another approach to scheduling was developed and promoted by Eli Goldratt.³ He first described it in his book *The Goal*. Goldratt avoided much of the complexity often associated with scheduling problems by simply focusing on *bottleneck* operations (i.e., those for which there was insufficient capacity—in effect, a work center with

zero idle time). He reasoned the output of the system was limited by the output of the bottleneck operation(s); therefore, it was essential to schedule the nonbottleneck operations in a way that minimized the idle time of the bottleneck operation(s). Thus, idle time of nonbottleneck operations was not a factor in overall productivity of the system, as long as the bottleneck operations were used effectively. These observations have been refined into a series of scheduling principles that include:

- An hour lost at a bottleneck operation is an hour lost by the system. The bottleneck operation determines the overall capacity of the system.
- Saving time through improvements of a nonbottleneck will not increase the ultimate output of the system.
- Activation of a resource is not the same as utilization of a resource. Because a nonbottleneck operation is active does not necessarily mean it is being useful.

These principles are also the foundation of a specific scheduling technique for intermittent production systems, one that many firms have found simpler and less time-consuming to use than traditional analytical techniques. This technique uses a *drum-buffer-rope* conceptualization to manage the system. The “drum” is the schedule; it sets the pace of production. The goal is to schedule to make maximum use of bottleneck resources. The “buffer” refers to potentially constraining resources outside of the bottleneck. The role of the buffer is to keep a small amount of inventory ahead of the bottleneck operation to minimize the risk of having it be idle. The “rope” represents the synchronizing of the sequence of operations to ensure effective use of the bottleneck operations. The goal is to avoid costly and time-consuming multiple setups, particularly of capacity-constrained resources, so they do not become bottlenecks too.

³Eli Goldratt, *The General Theory of Constraints* (New Haven, CT: Avraham Y. Institute, 1989).

The drum-buffer-rope approach provides a basis for developing a schedule that achieves maximum output and shorter lead times while avoiding carrying excess inventory. Use of the drum-buffer-rope approach generally results in operations capable of consistent on-time delivery, reduced inventory, and shorter lead times, as well as a reduction in disruptions that require expediting.

Goldratt also developed a system of varying batch sizes to achieve the greatest output of bottleneck operations. He used the term **process batch** to denote the basic lot size for a job, and the term **transfer batch** to denote a portion of the basic lot that could be used during production to facilitate utilization of bottleneck operations. In effect, a lot could be split into two or more parts. Splitting a large lot at one or more operations preceding a bottleneck operation would reduce the waiting time of the bottleneck operation.

Traditional management has emphasized maximizing output of every operation. In contrast to that approach, the **theory of constraints** has as its goal maximizing flow through the entire system, which it does by emphasizing balancing the flow through the various operations. It begins with identifying the bottleneck operation. Next, there is a five-step procedure to improve the performance of the bottleneck operation:

1. Determine what is constraining the operation.
2. Exploit the constraint (i.e., make sure the constraining resource is used to its maximum).
3. Subordinate everything to the constraint (i.e., focus on the constraint).
4. Determine how to overcome (eliminate) the constraint.
5. Repeat the process for the next highest constraint.

(Note the similarity to the plan-do-study-act [PDSA] approach discussed in Chapter 9.)

The goal, of course, is to make improvements. The theory of constraints uses three metrics to assess the effectiveness of improvements:

- **Throughput:** The rate at which the system generates *money* through sales (i.e., the contribution margin, or sales revenue less variable costs; labor costs are considered to be part of operating expense)
- **Inventory:** Inventory represents *money* tied up in goods and materials used in a process
- **Operating expense:** All the *money* the system spends to convert inventory into throughput; this includes utilities, scrap, depreciation, and so on

Goldratt's ideas are applicable to both manufacturing and service environments.

16.3 SCHEDULING SERVICES

Scheduling service systems presents certain problems not generally encountered in manufacturing systems. This is due primarily to (1) the inability to store or inventory services, (2) the random nature of customer requests for service, and (3) the fact that when waiting customers can observe the service, first-come-first served is used even though it isn't the most efficient system. In some situations, the second difficulty can be moderated by using appointment or reservation systems, but the inability to store services in most cases is a fact of life that managers must contend with.

The approach used to schedule services generally depends on whether customer contact is involved. In back-office operations, where there is little or no customer contact—such as processing mail-order requests, loan approvals, and tax preparation—the same priority rules described in the preceding pages are used. The goal is to maximize worker efficiency, and work is often processed in batches. A key factor can be the due date, say for rush orders, orders where the customer has paid a premium for faster-than-normal delivery. That is similar to the situation that occurs in front-office operations, where there is a high degree of customer contact, and efficiency may become secondary to keeping customer waiting times to reasonable levels, so scheduling the workforce to meet demand becomes a priority. Having too few workers causes waiting lines to form, but having more workers than needed increases labor costs, which can have a substantial impact on profits, particularly in service systems where labor is the major cost involved.

Process batch The economical quantity to produce upon the activation of a given operation.

Transfer batch The quantity to be transported from one operation to another, assumed to be smaller than the first operation's process batch.

Theory of constraints Production planning approach that emphasizes balancing flow throughout a system, and pursues a perpetual five-step improvement process centered around the system's currently most restrictive constraint.

LO16.10 Summarize some of the unique problems encountered in service systems, and describe some of the approaches used for scheduling service systems.

An ideal situation is one that has a smooth flow of customers through the system. This would occur if each new customer arrives at the precise instant that the preceding customer's service is completed, as in a physician's office, or in air travel if the demand just equals the number of available seats. In each of these situations, customer waiting time would be minimized, and the service system staff and equipment would be fully utilized. Unfortunately, the random nature of customer requests for service that generally prevails in service systems makes it nearly impossible to provide service capability that matches demand. Moreover, if service times are subject to variability—say, because of differing processing requirements—the inefficiency of the system is compounded. The inefficiencies can be reduced if arrivals can be scheduled (e.g., appointments), as in the case of doctors and dentists. However, in many situations, appointments are not possible (supermarkets, gas stations, theaters, hospital emergency rooms, repair of equipment breakdowns). Chapter 18, on waiting lines, focuses on those kinds of situations. There, the emphasis is on intermediate-term decisions related to service capacity. In this section, we will concern ourselves with short-term *scheduling*, in which much of the capacity of a system is essentially fixed, and the goal is to achieve a certain degree of customer service by efficient utilization of that capacity.

Scheduling in service systems may involve scheduling (1) customers, (2) the workforce, and (3) equipment. Scheduling customers often takes the form of appointment systems or reservation systems.

Appointment Systems

Appointment systems are intended to control the timing of customer arrivals in order to minimize customer waiting while achieving a high degree of capacity utilization. A doctor can use an appointment system to schedule patients' office visits during the afternoon, leaving the mornings free for hospital duties. Similarly, an attorney can schedule client meetings around court appearances. Even with appointments, however, problems can still arise due to lack of punctuality on the part of patients or clients, no-shows, and the inability to completely control the length of contact time (e.g., a dentist might run into complications in filling a tooth and have to spend additional time with a patient, thus backing up later appointments). Some of this can be avoided by trying to match the time reserved for a patient or client with the specific needs of that case rather than setting appointments at regular intervals. Even with the problems of late arrivals and no-shows, the appointment system is a tremendous improvement over random arrivals.

Reservation Systems

Reservation systems are designed to enable service systems to formulate a fairly accurate estimate of the demand on the system for a given time period and to minimize customer disappointment generated by excessive waiting or an inability to obtain service. Reservation systems are widely used by resorts, hotels and motels, restaurants, and some modes of transportation (e.g., airlines, car rentals). In the case of restaurants, reservations enable management to spread out or group customers so that demand matches service capabilities. Late arrivals and no-shows can disrupt the system. One approach to the no-show problem is to use decision theory (described in the supplement to Chapter 5). The problem also can be viewed as a single-period inventory problem, as described in Chapter 12.

Yield Management

Many companies, especially in the travel and tourist industries, operate with fixed capacities. Examples include hotels and motels, which operate with a fixed number of rooms to rent each night; airlines, which operate with a fixed number of seats to sell on any given flight; and cruise lines, which operate with a fixed number of berths to sell for any given cruise. The number of rooms, seats, or berths can be thought of as perishable inventory. For example, unsold seats on a flight cannot be carried over to the next flight; they are lost. The same is true for hotel rooms and cruise ship cabins. Of course, that unsold inventory does not generate income, so companies with fixed capacities must develop strategies to deal with sales.

Yield management is the application of pricing strategies to allocate capacity among various categories of demand with the goal of maximizing the revenue generated by the fixed capacity. Demand for fixed capacity usually consists of customers who make advance reservations and walk-ins. Customers who make advance reservations are typically price-sensitive, while walk-ins are often price-insensitive. Companies must decide on the percentage of their limited inventory to allocate to reservations, trading off lower revenue per unit for increased certainty of sales, and how much to allocate to walk-ins, where demand is less certain but revenue per unit is higher.

The ability to predict demand is critical to the success of yield management, so forecasting plays a key role in the process. Seasonal variations are generally important, so forecasts must incorporate seasonality and plans must also be somewhat flexible to allow for ever-present random variations.



Mark Wilson/Getty Images

The basic yield management concept is applicable to railroads as well as airlines. Yield management is multidisciplinary because it blends elements of marketing, operations, and financial management.

Yield management The application of pricing strategies to allocate capacity among various categories of demand.

Scheduling the Workforce

Scheduling customers is demand management. Scheduling the workforce is capacity management. This approach works best when demand can be predicted with reasonable accuracy. This is often true for restaurants, theaters, rush-hour traffic, and similar instances that have repeating patterns of intensity of customer arrivals. Scheduling hospital personnel, police, and delivery workers also come under this heading. An additional consideration is the extent to which variations in customer demands can be met with workforce flexibility. Thus, capacity can be adjusted by having cross-trained workers who can be temporarily assigned to help out on bottleneck operations during periods of peak demand.

Various constraints can affect workforce scheduling flexibility, including legal, behavioral, technical—such as workers' qualifications to perform certain operations—and budget constraints. Union or federal work rules and vacations can make scheduling more complicated.

Cyclical Scheduling

In many services (e.g., hospitals, police departments, fire departments, restaurants, and supermarkets), the scheduling requirements are fairly similar: Employees must be assigned to work shifts or time slots, and have days off, on a repeating or cyclical basis. The following is a method for determining both a schedule and the minimum number of workers needed.

Generally, a basic work pattern is set (e.g., work five consecutive days, have two consecutive days off), and a list of staffing needs for the schedule cycle (usually one week) is given. For example:

Day	Mon	Tue	Wed	Thu	Fri	Sat	Sun
Staff needed	2	4	3	4	6	5	5

A fairly simple but effective approach for determining the minimum number of workers needed is the following: Begin by repeating the staff needs for worker 1. Then,

1. Make the first worker's assignment such that the two days with the lowest need (i.e., lowest sum) are designated as days off. Here, Mon–Tue have the two lowest consecutive requirements. Circle those days. (Note, in some instances, Sun–Mon might yield the two lowest days.) In case of a tie, pick the pair with the lowest adjacent requirement day to the left or day to the right. If there is still a tie, pick arbitrarily.

Day	Mon	Tue	Wed	Thu	Fri	Sat	Sun
Staff needed	2	4	3	4	6	5	5
Worker 1	2	4	3	4	6	5	5

2. Subtract one from each day’s requirement, except for the circled days. Assign the next employee, again using the two lowest consecutive days as days off. Circle those days.

Day	Mon	Tue	Wed	Thu	Fri	Sat	Sun
Staff needed	2	4	3	4	6	5	5
Worker 1	2	4	3	4	6	5	5
Worker 2	2	4	2	3	5	4	4

3. Repeat the preceding step for each additional worker until all staffing requirements have been met. However, don’t subtract from a value of zero. Note the tie for worker 3: Mon–Tue and Sun–Mon have the lowest consecutive requirements; 4. The Mon–Tue two adjacents are Sun = 3 and Wed = 2, for a total of 5, which is less than the two adjacents for Sun–Mon (Sat = 3 and Tue = 3 for a total of 6). So, circle Mon–Tue requirements for worker 3. Worker 4 also has a tie, and adjacents Sat and Tue total 5, whereas Tue–Fri adjacents total 6, so circle Sun–Mon requirements.

Day	Mon	Tue	Wed	Thu	Fri	Sat	Sun
Staff needed	2	4	3	4	6	5	5
Worker 1	2	4	3	4	6	5	5
Worker 2	2	4	2	3	5	4	4
Worker 3	1	3	2	3	4	3	3
Worker 4	1	3	1	2	3	2	2 (tie)
Worker 5	1	2	0	1	2	1	2
Worker 6	0	1	0	1	1	0	1 (multiple ties)
Worker 7	0	1	0	0	0	0	0 (multiple ties)
No. working:	2	4	3	4	6	5	5

For Worker 7, circle Wed and Thu 0 0.

To identify the days each worker is working, go across each worker’s row to find the non-zero values not circled, signifying that the worker is assigned for those days. Similarly, to find the workers assigned to work for any particular day, go down that day’s column to find the nonzero values not circled. *Note:* Worker 6 will only work three days, and worker 7 will only work one day.

Scheduling Multiple Resources

In some situations, it is necessary to coordinate the use of more than one resource. For example, hospitals must schedule surgeons, operating room staffs, recovery room staffs, admissions, special equipment, nursing staffs, and so on. Educational institutions must schedule faculty, classrooms, audiovisual equipment, and students. As you might guess, the greater the number of resources to be scheduled simultaneously, the greater the complexity and the less likely an optimum schedule can be achieved. The problem is further complicated by the variable nature of such systems. For example, educational institutions frequently change their course offerings, student enrollments change, and students exhibit different course-selection patterns.

Some schools and hospitals are using computer software to assist them in devising acceptable schedules, although many appear to be using intuitive approaches with varying degrees of success.

Airlines are another example of service systems that require the scheduling of multiple resources. Flight crews, aircraft, baggage handling equipment, ticket counters, gate personnel, boarding ramps, food service, cleaning, and maintenance personnel all have to be coordinated. Furthermore, government regulations on the number of hours a pilot can spend flying place an additional restriction on the system. Another interesting variable is that, unlike most systems, the flight crews and the equipment do not remain in one location. Moreover, the crew and the equipment are not usually scheduled as a single unit. Flight crews are often scheduled so that they return to their base city every two days or more, and rest breaks must be considered. On the other hand, the aircraft may be in almost continuous use except for periodic maintenance and repairs. Consequently, flight crews commonly follow different trip patterns than that of the aircraft.

Service systems are prone to slowdowns when variability in demand for services causes bottlenecks. Part of the difficulty lies in predicting which operations will become bottlenecks. Moreover, bottlenecks may shift with the passage of time, so that different operations become bottleneck operations—further complicating the problem.

16.4 OPERATIONS STRATEGY

Scheduling can either help or hinder operations strategy. If scheduling is done well, goods or services can be made or delivered in a timely manner. Resources can be used to best advantage and customers will be satisfied. Scheduling not performed well will result in an inefficient use of resources and possibly dissatisfied customers.

The implication is clear: Management should not overlook the important role that scheduling plays in the success of an organization and the supply chain, giving a competitive advantage if done well or a disadvantage if done poorly. Time-based competition depends on good scheduling. Coordination of materials, equipment use, and employee time is an important function of operations management. It is not enough to have good design, superior quality, and the other elements of a well-run organization if scheduling is done poorly—just as it is not enough to own a well-designed and well-made car, with all the latest features for comfort and safety, if the owner doesn't know how to drive it!

Scheduling involves the timing and coordination of operations. Such activities are fundamental to virtually every organization. Scheduling problems differ according to whether a system is designed for high volume, intermediate volume, or low volume. Scheduling problems are particularly complex for job shops (low volume) because of the variety of jobs these systems are required to process.

The two major problems in job-shop scheduling are assigning jobs to machines or work centers, and designating the sequence of job processing at a given machine or work center. Gantt load charts are frequently employed to help managers visualize workloads, and they are useful for describing and analyzing sequencing alternatives. In addition, both heuristic and optimizing methods are used to develop loading and sequencing plans. For the most part, the optimization techniques can be used only if certain assumptions can be made.

Customer requirements in service systems generally present very different circumstances than those encountered in manufacturing systems. Some services can use appointments and reservations for scheduling purposes, although not all systems are amenable to this. When multiple resources are involved, the task of balancing the system can be fairly complex.

1. Scheduling occurs in every business organization.
2. Scheduling decisions are made within constraints established by decisions on capacity, product or service design, process selection and layout, aggregate planning, and master scheduling.
3. Scheduling decisions occur just prior to the conversion of inputs into outputs.
4. Effective scheduling can reduce costs and increase productivity.

SUMMARY

KEY POINTS

KEY TERMS

assignment model, 701	input/output (I/O) control, 700	priority rules, 704
backward scheduling, 699	job flow time, 705	process batch, 715
finite loading, 698	job lateness, 705	schedule chart, 700
flow-shop scheduling, 695	job-shop scheduling, 697	scheduling, 693
flow system, 695	job time, 704	sequencing, 704
forward scheduling, 699	Johnson's rule, 711	theory of constraints, 715
Gantt chart, 697	load chart, 698	transfer batch, 715
global priority rules, 704	loading, 697	workstation, 704
Hungarian method, 701	local priority rules, 704	yield management, 717
infinite loading, 698	makespan, 705	

SOLVED PROBLEMS

Problem 1 *The assignment method.* The following table contains information on the cost to run three jobs on four available machines. Determine an assignment plan that will minimize costs.

		MACHINE			
		A	B	C	D
Job	1	12	16	14	10
	2	9	8	13	7
	3	15	12	9	11

Solution In order for us to be able to use the assignment method, the numbers of jobs and machines must be equal. To remedy this situation, add a *dummy* job with costs of 0, and then solve as usual.

		MACHINE			
		A	B	C	D
Job	1	12	16	14	10
	2	9	8	13	7
	3	15	12	9	11
(dummy)	4	0	0	0	0

a. Subtract the smallest number from each row. The results are:

		MACHINE			
		A	B	C	D
Job	1	2	6	4	0
	2	2	1	6	0
	3	6	3	0	2
	4	0	0	0	0

b. Subtract the smallest number in each column. (Because of the dummy zeroes in each column, the resulting table will be unchanged.)

c. Determine the minimum number of lines needed to cross out the zeroes. One possible way is as follows:

		MACHINE			
		A	B	C	D
Job	1	2	6	4	0
	2	2	1	6	0
	3	6	3	0	2
	4	0	0	0	0

- d. Because the number of lines is less than the number of rows, modify the numbers.
- (1) Subtract the smallest uncovered number (1) from each uncovered number.
 - (2) Add the smallest uncovered number to numbers at line intersections. The result is:

		MACHINE			
		A	B	C	D
Job	1	1	5	4	0
	2	1	0	6	0
	3	5	2	0	2
	4	0	0	1	1

- e. Test for optimality:

		MACHINE			
		A	B	C	D
Job	1	1	5	4	0
	2	1	0	6	0
	3	5	2	0	2
	4	0	0	1	1

Because the minimum number of lines equals the number of rows, an optimum assignment can be made.

- f. Assign jobs to machines. Start with rows 1 and 3, because they each have one zero, and columns A and C, also with one zero each. After each assignment, cross out all the numbers in that row and column. The result is:

		MACHINE			
		A	B	C	D
Job	1	1	5	4	0
	2	1	0	6	0
	3	5	2	0	2
	4	0	0	1	1

Notice there is only one assignment in each row, and only one assignment in each column.

- g. Compute total costs, referring to the original table.

1-D	\$10
2-B	8
3-C	9
4-A	0
	\$27

- h. The implication of assignment 4-A is that machine A will not be assigned a job. It may remain idle or be used for another job.

Priority rules. Job times (including processing and setup) are shown in the following table for five jobs waiting to be processed at a work center.

Problem 2

Job	Job Time (hours)	Due Date (hours)
a	12	15
b	6	24
c	14	20
d	3	8
e	7	6

Determine the processing sequence that would result from each of these priority rules:

- a. SPT
- b. EDD

Solution Assume job times are independent of processing sequence.

Job	a. SPT		b. EDD	
	Job Time	Processing Order	Hour Due	Processing Order
a	12	4	15	3
b	6	2	24	5
c	14	5	20	4
d	3	1	8	2
e	7	3	6	1

Problem 3 *Priority rules.* Using the job times and due dates from Solved Problem 2, determine each of the following performance measures for first-come, first-served processing order: Assume jobs listed in order of arrival.

- Makespan
- Average flow time
- Average tardiness
- Average number of jobs at the workstation

Solution

Job	Job Time	Flow Time	Hour Due	Hours Tardy
a	12	12	15	0
b	6	18	24	0
c	14	32	20	12
d	3	35	8	27
e	7	42	6	36
Total	42	139		75

- Makespan = 42 hours
- Average flow time = $\frac{\text{Total flow time}}{\text{Number of jobs}} = \frac{139}{5} = 27.80$ hours
- Average tardiness = $\frac{\text{Total hours tardy}}{\text{Number of jobs}} = \frac{75}{5} = 15$ hours
- Average number of jobs at workstation = $\frac{\text{Total flow time}}{\text{Makespan}} = \frac{139}{42} = 3.31$

Problem 4 *S/O rule.* Using the following information, determine an order processing sequence using the S/O priority rule.

Order	Processing Time Remaining (days)	Due Date (days)	Number of Operations Remaining
A	20	30	2
B	11	18	5
C	10	6	2
D	16	23	4

Assume times are independent of processing sequence.

Solution

Order	(1) Remaining Processing Time	(2) Due Date	(3) – (1) Slack	(4) Number of Operations	(5) Ratio	(6) Rank (sequence)
A	20	30	10	2	5.00	4
B	11	18	7	5	1.40	2
C	10	6	-4	2	-2.00	1
D	16	23	7	4	1.75	3

(Note that one ratio is negative. When negatives occur, assign the *lowest* rank to the *most negative* number.)

Sequencing jobs through two work centers. Use Johnson’s rule to obtain the optimum sequence for processing the jobs shown through work centers A and B.

Problem 5

Job	JOB TIMES (hours)	
	Work Center A	Work Center B
a	2.50	4.20
b	3.80	1.50
c	2.20	3.00
d	5.80	4.00
e	4.50	2.00

- Identify the smallest time: job b (1.50 hours at work center B). Because the time is for B, schedule this job last.
- The next smallest time is job e (2.00 hours at B). Schedule job e next to last.
- Identify the smallest remaining job time: job c (2.20 hours at center A). Because the time is in the A column, schedule job c first. At this point, we have: c, _____, _____, e, b
- The smallest time for the remaining jobs is 2.50 hours for job a at center A. Schedule this job after job c. The one remaining job (job d) fills the remaining slot. Thus, we have c-a-d-e-b.

Solution

For Solved Problem 5, determine what effect splitting jobs c, d, e, and b in work center A would have on the idle time of work center B and on the throughput time. Assume that each job can be split into two equal parts.

Problem 6

We assume that the processing sequence remains unchanged and proceed on that basis. The solution from the previous problem is shown in the following chart. The next chart shows reduced idle time at center B when splitting is used.

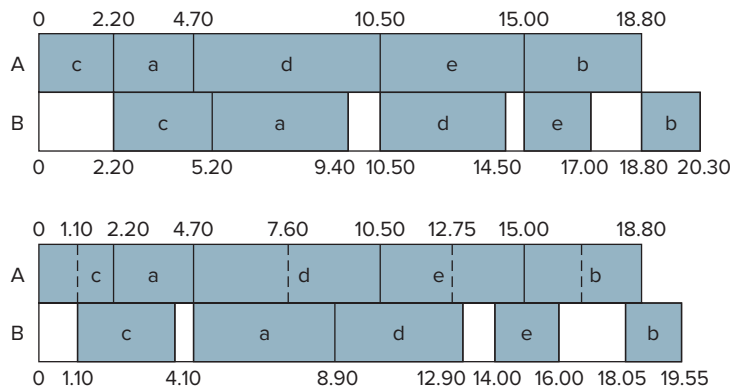

An inspection of these two figures reveals that throughput time has decreased from 20.30 hours to 19.55 hours. In addition, the original idle time was 5.6 hours. After splitting certain jobs, it was reduced to 4.85 hours, so some improvement was achieved. Note that processing times at B are generally less than at A for jobs toward the end of the sequence. As a result, jobs such as e and b at B were scheduled so that they were *centered* around the finishing times of e and b, respectively, at A, to avoid having to break the jobs due to waiting for the remainder of the split job from A. Thus, the greatest advantage from job splitting generally comes from splitting earlier jobs when Johnson's rule is used for sequencing.

DISCUSSION AND REVIEW QUESTIONS

1. Why is scheduling fairly simple for repetitive systems but fairly complex for job shops?
2. What are the main decision areas of job-shop scheduling?
3. What are Gantt charts? How are they used in scheduling? What are the advantages of using Gantt charts?
4. What are the basic assumptions of the assignment method of linear programming?
5. Briefly describe each of the following priority rules:
 - a. FCFS
 - b. SPT
 - c. EDD
 - d. S/O
 - e. Rush
6. Why are priority rules needed?
7. What problems not generally found in manufacturing systems do service systems present in terms of scheduling the use of resources?
8. Explain forward and backward schedulings and each one's advantage.
9. How are scheduling and productivity related?
10. What factors would you take into account in deciding whether to split a job?
11. Explain the term *makespan*.

TAKING STOCK

1. What general trade-offs are involved in sequencing decisions? In scheduling decisions?
2. Who needs to be involved in setting schedules?
3. How has technology had an impact on scheduling?

CRITICAL THINKING EXERCISES

1. One approach that can be effective in reducing the impact of production bottlenecks in a job shop or batch operations setting is to use smaller lot sizes.
 - a. What is the impact of a production bottleneck?
 - b. Explain how small lot sizes can reduce the impact of bottleneck operations.
 - c. What are the key trade-offs in using small lot sizes for the purpose of reducing the bottleneck effect?
 - d. In some cases, the location of a bottleneck will shift (i.e., sometimes it is at workstation 3, another time it is at workstation 12). Furthermore, there can be more than one bottleneck operation at the same time. How would these situations impact scheduling using small lot sizes?
2. Doctors' and dentists' offices frequently schedule patient visits at regularly spaced intervals. What problems can this create? Can you suggest an alternative approach to reduce these problems? Under what circumstances would regularly spaced appointments constitute a reasonable approach to patient scheduling?
3. Name three examples of unethical behavior involving scheduling and state the ethical principle each violates.

PROBLEMS

1. Use the assignment method to determine the best way to assign workers to jobs, given the following cost information. Compute the total cost for your assignment plan.

		JOB		
		A	B	C
Worker	1	5	8	6
	2	6	7	9
	3	4	5	3

2. Rework Problem 1, treating the numbers in the table as profits instead of costs. Compute the total profit.
3. Assign trucks to delivery routes so that total costs are minimized, given the cost data shown. What is the total cost?

		ROUTE				
		A	B	C	D	E
Truck	1	4	5	9	8	7
	2	6	4	8	3	5
	3	7	3	10	4	6
	4	5	2	5	5	8
	5	6	5	3	4	9

4. Develop an assignment plan that will minimize processing costs, given the information shown, and interpret your answer.

		WORKER		
		A	B	C
Job	1	12	8	11
	2	13	10	8
	3	14	9	14
	4	10	7	12

5. Use the assignment method to obtain a plan that will minimize the processing costs in the following table under these conditions:
- The combination 2-D is undesirable
 - The combinations 1-A and 2-D are undesirable

		WORKER				
		A	B	C	D	E
Job	1	14	18	20	17	18
	2	14	15	19	16	17
	3	12	16	15	14	17
	4	11	13	14	12	14
	5	10	16	15	14	13

6. The following table contains information concerning four jobs that are awaiting processing at a work center.

Job	Job Time (days)	Due Date (days)
A	14	20
B	10	16
C	7	15
D	6	17

- Sequence the jobs using (1) FCFS, (2) SPT, (3) EDD, and (4) CR. Assume the list is by order of arrival.
 - For each of the methods in part *a*, determine (1) the average job flow time, (2) the average tardiness, and (3) the average number of jobs at the work center.
 - Is one method superior to the others? Explain.
7. Using the information presented in the following table, identify the processing sequence that would result using (1) FCFS, (2) SPT, (3) EDD, and (4) CR. For each method, determine (1) average job flow time, (2) average job tardiness, and (3) average number of jobs in the system. Jobs are listed in order of arrival. (*Hint*: First determine the total job time for each job by computing the total processing time for the job and then adding in the setup time. All times and due dates are in hours.)

Job	Processing Time per Unit	Units per Job	Setup Time	Due Date
a	.14	45	0.7	4
b	.25	14	0.5	10
c	.10	18	0.2	12
d	.25	40	1.0	20
e	.10	75	0.5	15

8. The following table shows orders to be processed at a machine shop as of 8:00 a.m. Monday. The jobs have different operations they must go through. Processing times are in days. Jobs are listed in order of arrival.
- Determine the processing sequence at the first work center using each of these rules: (1) FCFS, (2) S/O.
 - Compute the effectiveness of each rule using each of these measures: (1) average flow time, (2) average number of jobs at the work center.

Job	Processing Time (days)	Due Date (days)	Remaining Number of Operations
A	8	20	2
B	10	18	4
C	5	25	5
D	11	17	3
E	9	35	4

9. A wholesale grocery distribution center uses a two-step process to fill orders. Tomorrow's work will consist of filling the seven orders shown. Determine a job sequence that will minimize the time required to fill the orders.

Order	TIME (hours)	
	Step 1	Step 2
A	1.20	1.40
B	0.90	1.30
C	2.00	0.80
D	1.70	1.50
E	1.60	1.80
F	2.20	1.75
G	1.30	1.40

10. The times required to complete each of eight jobs in a two-machine flow shop are shown in the table that follows. Each job must follow the same sequence, beginning with machine A and moving to machine B.
- Determine a sequence that will minimize makespan time.
 - Construct a chart of the resulting sequence, and find machine B's idle time.

- c. For the sequence determined in part *a*, how much would machine B's idle time be reduced by splitting the last two jobs in half?

Job	TIME (hours)	
	Machine A	Machine B
a	16	5
b	3	13
c	9	6
d	8	7
e	2	14
f	12	4
g	18	14
h	20	11

11. Given the operation times provided:
- Develop a job sequence that minimizes idle time at the two work centers.
 - Construct a chart of the activities at the two centers, and determine each one's idle time, assuming no other activities are involved.

	JOB TIMES (minutes)					
	A	B	C	D	E	F
Center 1	20	16	43	60	35	42
Center 2	27	30	51	12	28	24

12. A shoe repair operation uses a two-step sequence that all jobs in a certain category follow. All jobs can be split in half at both stations. For the group of jobs listed:
- Find the sequence that will minimize total completion time.
 - Determine the amount of idle time for workstation B.
 - What jobs are candidates for splitting? Why? If they were split, how much would idle time and makespan time be reduced?

	JOB TIMES (minutes)				
	A	B	C	D	E
Workstation A	27	18	70	26	15
Workstation B	45	33	30	24	10

13. The following schedule was prepared by the production manager of Marymount Metal Shop: Determine a schedule that will result in the earliest completion of all jobs on this list.

Job	CUTTING		POLISHING	
	Start	Finish	Start	Finish
A	0	2	2	5
B	2	6	6	9
C	6	11	11	13
D	11	15	15	20
E	15	17	20	23
F	17	20	23	24
G	20	21	24	28

14. The production manager must determine the processing sequence for seven jobs through the grinding and then deburring departments. The same sequence will be followed in both departments. The manager's goal is to move the jobs through the two departments as quickly as possible. The foreman of the deburring department wants the SPT rule to be used to minimize the work-in-process inventory in his department.

Job	PROCESSING TIME (hours)	
	Grinding	Deburring
A	3	6
B	2	4
C	1	5
D	4	3
E	9	4
F	8	7
G	6	2

- Prepare a schedule using SPT for the grinding department.
 - What is the flow time in the grinding department for the SPT sequence? What is the total time needed to process the seven jobs in both the grinding and deburring departments?
 - Determine a sequence that will minimize the total time needed to process the jobs in both departments. What flow time will result for the grinding department?
 - Discuss the trade-offs between the two alternative sequencing arrangements. At what point would the production manager be indifferent concerning the choice of sequences?
15. A foreman has determined processing times at a work center for a set of jobs and now wants to sequence them. Given the information shown, do the following:
- Determine the processing sequence using (1) FCFS, (2) SPT, (3) EDD, and (4) CR. For each sequence, compute the average job tardiness, the average flow time, and the average number of jobs at the work center. The list is in FCFS order.
 - Using the results of your calculations in part *a*, show that the ratio of average flow time and the average number of jobs measures are equivalent for all four sequencing rules.
 - Determine the processing sequence that would result using the *S/O* rule.

Job	Job Time (days)	Due Date	Operations Remaining
a	4.5	10	3
b	6.0	17	4
c	5.2	12	3
d	1.6	27	5
e	2.8	18	3
f	3.3	19	1

16. Given the information in the following table, determine the processing sequence that would result using the *S/O* rule.

Job	Remaining Processing Time (days)	Due Date	Remaining Number of Operations
a	5	8	2
b	6	5	4
c	9	10	4
d	7	12	3
e	8	10	2

17. Given the following information on job times and due dates, determine the optimal processing sequence using (1) FCFS, (2) SPT, (3) EDD, and (4) CR. For each method, find the average job flow time and the average job tardiness. Jobs are listed in order of arrival.

Job	Job Time (hours)	Due Date (hours)
a	3.5	7
b	2.0	6
c	4.5	18
d	5.0	22
e	2.5	4
f	6.0	20

18. The Budd Gear Co. specializes in heat-treating gears for automobile companies. At 8:00 a.m., when Budd's shop opened today, five orders (listed in order of arrival) were waiting to be processed.

Order	Order Size (units)	Per Unit Time in Heat Treatment (minutes/unit)	Due Date (min. from now)
A	16	4	160
B	6	12	200
C	10	3	180
D	8	10	190
E	4	1	220

- If the earliest due date rule is used, what sequence should be used?
 - What will be the average job tardiness?
 - What will be the average number of jobs in the system?
 - Would the SPT rule produce better results in terms of job tardiness?
19. The following table contains order-dependent setup times for three jobs. Which processing sequence will minimize the total setup time?

		Following Job's Setup Time (hrs.)			
		Setup Time (hrs.)	A	B	C
Preceding Job	A	2	—	3	5
	B	3	8	—	2
	C	2	4	3	—

20. The following table contains order-dependent setup times for three jobs. Which processing sequence will minimize the total setup time?

		Following Job's Setup Time (hrs.)			
		Setup Time (hrs.)	A	B	C
Preceding Job	A	2.4	—	1.8	2.2
	B	3.2	0.8	—	1.4
	C	2.0	2.6	1.3	—

21. The following table contains order-dependent setup times for four jobs. For safety reasons, job C cannot follow job A, nor can job A follow job C. Determine the processing sequence that will minimize the total setup time. (*Hint:* There are 12 alternatives.)

		Following Job's Setup Time (hrs.)				
		Setup Time (hrs.)	A	B	C	D
Preceding job	A	2	—	5	×	4
	B	1	7	—	3	2
	C	3	×	2	—	2
	D	2	4	3	6	—

22. Given this information on planned and actual inputs and outputs for a service center, determine the work backlog for each period. The beginning backlog is 12 hours of work. The figures shown are standard hours of work.

		PERIOD				
		1	2	3	4	5
Input	Planned	24	24	24	24	20
	Actual	25	27	20	22	24
Output	Planned	24	24	24	24	23
	Actual	24	22	23	24	24

23. Given the following data on inputs and outputs at a work center, determine the cumulative deviation and the backlog for each time period. The beginning backlog is 7.

		PERIOD					
		1	2	3	4	5	6
Input	Planned	200	200	180	190	190	200
	Actual	210	200	179	195	193	194

		PERIOD					
		1	2	3	4	5	6
Output	Planned	200	200	180	190	190	200
	Actual	205	194	177	195	193	200

24. Determine the minimum number of workers needed, and a schedule for the following staffing requirements, giving workers two consecutive days off per cycle (not including Sunday).

Day	Mon	Tue	Wed	Thu	Fri	Sat
Staff needed	2	3	1	2	4	3

25. Determine the minimum number of workers needed, and a schedule for the following staffing requirements, giving workers two consecutive days off per cycle (not including Sunday).

Day	Mon	Tue	Wed	Thu	Fri	Sat
Staff needed	3	4	2	3	4	5

26. Determine the minimum number of workers needed, and a schedule for the following staffing requirements, giving workers two consecutive days off per cycle (not including Sunday).

Day	Mon	Tue	Wed	Thu	Fri	Sat
Staff needed	4	4	5	6	7	8



It was a little past 9:00 on a Monday morning when Jeff Baker walked into your office with a box of donuts.

“I’ve been talking with Anne about a problem we have with short-term capacity in our pad printing operation. You know, that’s where we print the logo on the custom lines of yo-yos. We have received more orders than usual for July, and I want to release the orders to pad printing in a way that will enable us to meet our due date commitments in the best way possible. Would you have time to look at the order list (attached) and see what kind of schedule we should follow to do that? By the way, you have established quite a reputation in your short stay here. You have a talent for really explaining why your recommendations are the best approach in a way that all of us ‘over-the-hill’ managers can understand. Please be sure to do that for me, too. I want to understand why your recommendation is the best schedule and what the trade-offs are for other possible schedules—and none of that philosophical college mumbo-jumbo. Remember, I came up through the ranks. I don’t have one of those sheepskins on my wall,” he says with a laugh.

Because your schedule was back to normal after that MRP report you did for Anne, you agreed to look at the information. After that compliment, how could you say no? “Try to get back to me within a couple of days,” Jeff said as he left your office.

After a few minutes with your old operations management text, you call the production control office to confirm the pad printing schedule. They confirm that pad printing runs one eight-hour shift per day. They tell you that due to a make-up day for flooding in June, pad printing will be running 23 days in July, beginning Friday, July 1 (they will work three Saturdays on July 9, 16, and 23, and take a one-day holiday for July 4).

You thank them for the information and then begin to develop your plan.

Even though Jeff lacks a college degree, from what you have seen, he is very sharp. And obviously he knows good work when he sees it, because he liked, and apparently understood, your past work. You resolve to cover all the bases, but in a way that is as clear as possible.

PAD PRINTING ORDER LIST

Job	Date Order Received	Setup Time	Production Time	Due Date ¹
A	6/4	2 hrs.	6 days	11 July
B	6/7	4 hrs.	2 days	8 July
C	6/12	2 hrs.	8 days	25 July
D	6/14	4 hrs.	3 days	19 July
E	6/15	4 hrs.	9 days	29 July

¹Jobs are due at the beginning of their respective due dates.

Note: Setup time is to set up the pad printer at the start of the job. Setup includes thoroughly cleaning the printing heads and ink reservoirs, installing the new pad(s) and ink supply, and carefully aligning the machine. Setup at the beginning of a new day with the same job is insignificant.

Examine the following rules and write a report to Jeff Baker summarizing your findings, and advise him on which rule to use. Rules: FCFS, SPT, EDD, and CR.

Source: Victor E. Sower, “Hi-Ho, Yo-Yo, Inc.” Copyright © 2006 Victor E. Sower, PhD, CDE.

Goldratt, Eli, and Jeff Cox. *The Goal: A Process of Ongoing Improvement*, 3rd ed. Great Barrington, MA: North River Press, 2012.

Hopp, Wallace J., and Mark L. Spearman. *Factory Physics*, 3rd ed. New York: Irwin/McGraw-Hill, 2007.

Jacobs, F. Robert, William L. Berry, D. Clay Whybark, and Thomas E. Vollmann. *Manufacturing Planning and Control Systems*, 6th ed. New York: Irwin/McGraw-Hill, 2011.

Pinedo, Michael. *Planning and Scheduling in Manufacturing and Services*. New York: Springer, 2005.

**SELECTED
BIBLIOGRAPHY AND
FURTHER READINGS**

17

Project Management

CHAPTER

LEARNING OBJECTIVES

After completing this chapter, you should be able to:

- LO17.1** Describe the project life cycle.
- LO17.2** Discuss the behavioral aspects of projects in terms of project personnel and the project manager.
- LO17.3** Name the six key decisions in project management.
- LO17.4** Explain the nature and importance of a work breakdown structure in project management.
- LO17.5** Give a general description of PERT/CPM techniques.
- LO17.6** Construct simple network diagrams.
- LO17.7** Analyze networks with deterministic times.
- LO17.8** Analyze networks with probabilistic times.
- LO17.9** Describe activity “crashing” and solve typical problems.
- LO17.10** Discuss the advantages of using PERT and potential sources of error.
- LO17.11** Discuss the key steps in risk management.

CHAPTER OUTLINE

- | | | |
|---|---|--|
| 17.1 Introduction 734 | 17.6 PERT and CPM 742 | 17.13 Time–Cost Trade-Offs: Crashing 759 |
| 17.2 Project Life Cycle 734 | The Network Diagram 743 | 17.14 Advantages of Using PERT and Potential Sources of Error 762 |
| 17.3 Behavioral Aspects of Project Management 736 | Network Conventions 744 | 17.15 Critical Chain Project Management 763 |
| The Nature of Projects 736 | 17.7 Deterministic Time Estimates 745 | 17.16 Other Topics in Project Management 763 |
| Key Decisions in Project Management 737 | 17.8 A Computing Algorithm 746 | 17.17 Project Management Software 764 |
| The Project Manager 738 | Activity-on-Arrow 746 | 17.18 Operations Strategy 764 |
| Behavioral Issues 739 | Activity-on-Node 750 | 17.19 Risk Management 765 |
| Project Champions 740 | Computing Slack Times 752 | Case: Time, Please 783 |
| Certification 740 | 17.9 Probabilistic Time Estimates 753 | |
| The Pros and Cons of Working on Projects 740 | 17.10 Determining Path Probabilities 756 | |
| 17.4 Work Breakdown Structure 741 | 17.11 Simulation 758 | |
| 17.5 Planning and Scheduling with Gantt Charts 741 | 17.12 Budget Control 759 | |



Andrew Zarivny/iStock/Getty Images

Projects are a unique aspect of business operations that require a special management approach. Unlike many other aspects of business, which tend to operate more routinely, projects often have uncertainties and risks that tend to make managing them more challenging, such as the Hoover Dam bridge (shown above).

Examples of projects are many. Some are huge, such as building the space station, rescue and cleanup operations after major natural disasters, and hosting the Olympic Games. Others are smaller in scope, but still quite involved, such as producing a major motion picture, putting on a Broadway play, or producing a music video. They involve a tremendous amount of planning and coordinating set design, set building, script writing, camera crews, directors, actors or hosts, costumes, advertising, and more to accomplish project objectives while meeting budget and time constraints.

Consider the Olympic Games. They involve much more than the festivities, the excitement, national pride, and competition among athletes. They all involve a tremendous amount of planning, preparation, and coordinating work that needs to get done before and during the games. Athletes' living quarters and training facilities must be provided, sometimes building places where they will compete, competition schedules must be developed, arrangements for televising events must be made, equipment and crews must be coordinated, transportation and hotel accommodations must be made, and many other activities that go on behind the scenes must be planned and managed so that everything goes off smoothly.

continued

Microsoft Corporation periodically releases new or updated software. Each release is the result of many people working countless hours writing code, testing programs, and revising code. Design, production, and marketing efforts also have to be coordinated. The reputation and profits of the company are closely related to successful software development.

Not all projects are successful, and the consequences of project failure can be costly—even catastrophic. ERP installation projects (see Chapter 13) are expensive and time-consuming, and more than a few companies have terminated their projects after spending huge sums of money. Other examples include dam failures that result in massive flooding of homes, businesses, and crop land, flooded vehicles, and loss of lives.

This chapter introduces the basic concepts of project management. It includes a discussion of some behavioral aspects of project management, along with some of the difficulties project managers are apt to encounter. The main portion of the chapter is devoted to a description of graphical and computational methods that are used for planning and scheduling projects.

17.1 INTRODUCTION

Projects Unique, one-time operations designed to accomplish a specific set of objectives in a limited time frame.

Managers typically oversee a variety of operations. Some of these involve routine, repetitive activities, but others involve *nonroutine* activities. Under the latter heading are **projects**: unique, one-time operations designed to accomplish a set of objectives in a limited time frame. Examples of projects include constructing a shopping complex, merging two companies, putting on a play, and designing and running a political campaign. Examples of projects within business organizations include designing new products or services, designing advertising campaigns, designing information systems, reengineering a process, designing databases, software development, and designing web pages.

Projects may involve considerable cost. Some have a long time horizon, and some involve a large number of activities that must be carefully planned and coordinated. Most are expected to be completed based on time, cost, and performance targets. To accomplish this, goals must be established and priorities set. Tasks must be identified and time estimates made. Resource requirements also must be projected and budgets prepared. Once under way, progress must be monitored to assure that project goals and objectives will be achieved.

The project approach enables an organization to focus attention and concentrate efforts on accomplishing a narrow set of performance objectives within a limited time and budget framework. This can produce significant benefits compared with other approaches that might be considered. Even so, projects present managers with a host of problems that differ in many respects from those encountered with more routine activities. The problems of planning and coordinating project activities can be formidable for large projects, which typically have thousands of activities that must be carefully planned and monitored if the project is to proceed according to schedule and at a reasonable cost.

Projects can have strategic importance for organizations. For example, good project management can be instrumental in successfully implementing an enterprise resource planning (ERP) system or converting a traditional operation to a lean operation. And good project management is very important when virtual teams are used.

Table 17.1 provides an overview of project management.

17.2 PROJECT LIFE CYCLE

LO17.1 Describe the project life cycle.

The size, length, and scope of projects vary widely according to the nature and purpose of the project. Nevertheless, all projects have something in common: They go through a life cycle, which typically consists of five phases.

1. **Initiating.** This begins the process by outlining the expected costs, benefits, and risks associated with a project. It includes defining the major project goals and choosing a project manager.

What is project management? A team-based approach for managing projects.

How is it different from general operations management?

- Limited time frame
- Narrow focus; specific objectives
- Less bureaucratic

When is it used?

- When there are special needs that don't lend themselves to functional management
- When pressures exist for new or improved products or services, as well as cost reduction

What are the key metrics?

- Time
- Cost
- Performance objectives

What are the key success factors?

- Top-down commitment
- A respected and capable project manager
- Enough time to plan
- Careful tracking and control
- Good communications

What are the major administrative issues?

- Executive responsibilities:
 - a. Project selection
 - b. Selection of a project manager
 - c. Organizational structure (To whom will the project manager report?)
- Organizational alternatives:
 - a. Manage within functional unit
 - b. Assign a coordinator
 - c. Use a matrix organization with a project leader

What are the main tools?

- *Work breakdown structure*: An initial planning tool that is needed to develop a list of activities, activity sequences, and a realistic budget
- *Network diagram*: A "big picture" visual aid used to estimate project duration, identify activities critical for timely project completion, identify areas where slack time exists, and develop activity schedules
- *Gantt charts*: A visual aid used to plan and monitor individual activities
- *Risk management*: Analyses of potential failures or problems, assessment of their likelihood and consequences, and contingency plans

TABLE 17.1

Overview of project management

2. **Planning.** This phase provides details on deliverables, the scope of the project, the budget, schedule and milestones, performance objectives, resources needed, a quality plan, and a plan for handling risks. The accompanying documents generated in the planning phase will be used in the executing and monitoring phases to guide activities and monitor progress. Members of the project team are chosen.
3. **Executing.** In this phase, the actual work of the project is carried out. The project is managed as activities are completed, resources are consumed, and milestones are reached. Management involves what the Project Management Institute (www.pmi.org) refers to as the nine management areas: project integration, scope, human resources, communications, time, risk, quality, cost, and procurement.
4. **Monitoring and Controlling.** This phase occurs at the same time as project execution. It involves comparing actual progress with planned progress and undertakes corrective action if needed, as well as monitoring any corrective action to make sure it achieves the desired effect.
5. **Closing.** This phase ends the project. It involves handing off the project deliverables (assuming the project hasn't been canceled), obtaining customer acceptance, documenting lessons learned, and releasing resources.

FIGURE 17.1
Project life cycle

Source: Adapted from Clifford F. Gray and Erik W. Larson, *Project Management: The Managerial Process*, 2nd ed., p. 6. Copyright © 2003 McGraw-Hill Education, Inc. Used with permission.

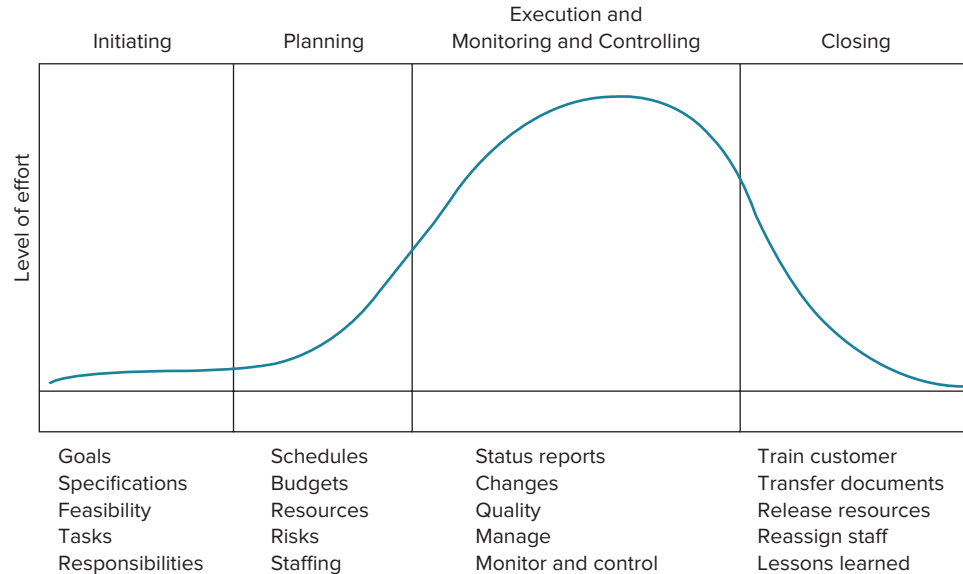

It should be noted that the phases can overlap, so that one phase may not be fully complete before the next phase begins. This can reduce the time necessary to move through the life cycle, perhaps generating some competitive advantage and cost saving. Although subsequent decisions in an earlier phase may result in waste for some portion of the activity in a following phase, careful coordination of activities can minimize that risk.

Figure 17.1 illustrates the phases in a project life cycle.

17.3 BEHAVIORAL ASPECTS OF PROJECT MANAGEMENT

LO17.2 Discuss the behavioral aspects of projects in terms of project personnel and the project manager.

Project management differs from management of more traditional activities mainly because of its limited time framework and the unique set of activities involved, which gives rise to a host of unique problems. This section describes more fully the nature of projects and their behavioral implications. Special attention is given to the role of the project manager.

The Nature of Projects

As projects go through their life cycle, a variety of skill requirements are involved. The circumstances are analogous to constructing a house. Initially, an idea is presented and its feasibility is assessed, then plans must be drawn up and approved by the owner and possibly a town building commission or other regulatory agency. Then, a succession of activities occurs, each with its own skill requirements, starting with the site preparation, then laying the foundation, erecting the frame, roofing, constructing exterior walls, wiring and plumbing, inspections of wiring and plumbing, installing kitchen and bathroom fixtures and appliances, interior finishing work, and painting and carpeting work. Similar sequences occur on construction projects, in R&D work, in the aerospace industry, and in virtually every other instance where projects are being carried out.

Projects typically bring together people with diverse knowledge and skills, most of whom remain associated with the project for less than its full life. Some people go from project to project as their contributions become needed, and others are “on loan,” either on a full-time or part-time basis, from their regular jobs. The latter is usually the case when a special project exists within the framework of a more traditional organization. However, some organizations are involved with projects on a regular basis; examples include consulting firms, architects, writers and publishers, and construction firms. In those organizations, it is not uncommon for some individuals to spend virtually all of their time on projects.

Some organizations use a *matrix organization* that allows them to integrate the activities of a variety of specialists within a functional framework. For instance, they have certain people who prepare proposals, others who concentrate exclusively on engineering, others who devote their efforts to marketing, and so on.

In a matrix organization, functional and project managers share workers. Project managers negotiate with functional managers for people to work on a project. Those selected will be temporarily assigned to the project manager. However, they are still responsible to their functional manager. They may work part-time or full-time on the project. When their work is done, they return to their functional department.

A matrix organization works quite well with people who can function with two managers, or even more than two if workers work on multiple projects. It can create synergy when people from various functional areas are brought together to work on a project. However, some people do not function well under such a structure, and may be stressed working in that environment. Matrix organizations typically do not allow long-term working relationships to develop. Furthermore, using multiple managers for one employee may result in uncertainty regarding employee evaluation and accountability.

Key Decisions in Project Management

Much of the success of projects depends on key managerial decisions over a sequence of steps:

- Deciding which projects to implement.
- Selecting the project manager.
- Selecting the project team.
- Planning and designing the project.
- Managing and controlling project resources.
- Deciding if and when a project should be terminated.

LO17.3 Name the six key decisions in project management.

Deciding Which Projects to Implement or to Bid On. This involves determining the criteria that will be used to decide which projects to pursue. Typical factors include budget, availability of appropriate knowledge and skill personnel, and cost–benefit considerations. Of course, other factors may override these criteria, such as availability of funds, safety issues, government-mandated actions, and so on.

Selecting the Project Manager. The project manager is the central person in the project. The following section on project managers discusses this topic.

Selecting the Project Team. The team can greatly influence the ultimate success or failure of a project. Important considerations include not only a person’s knowledge and skill base, but also how well the person works with others (particularly those who have already been chosen for the project), enthusiasm for the project, other projects the person is involved in, and how likely those other projects might be to interfere with work on this project.

Planning and Designing the Project. Project planning and design require decisions on project performance goals, a timetable for project completion, the scope of the project, what work needs to be done, how it will be done, if some portions will be outsourced, what resources will be needed, a budget, and when and how long resources will be needed.

Managing and Controlling Project Resources. This involves managing personnel, equipment, and the budget; establishing appropriate metrics for evaluating the project; monitoring progress; and taking corrective action when needed. Also necessary are designing an information system and deciding what project documents should be generated, their contents and format, when and by whom they will be needed, and how often they should be updated.



Kevin Mazur/Wire Image/Getty Images



Matt Kent/Redferns/Getty Images

The U2 360 Tour was named after the 360-degree staging and audience configuration it used for shows. To accommodate this, the stage set made use of a massive four-legged supporting rig that was nicknamed “The Claw.” The tour crew consisted of 137 touring crews supplemented by over 120 hired locally. Moving the massive set from venues took as long as 3½ days. First, sound and light equipment was packed into the fleet of trucks during the four hours following the concert; the remainder of the time was spent deconstructing the steel structures.

Deciding If and When a Project Should Be Terminated before Completion. Sometimes it is better to terminate a project than to invest any more resources. Important considerations here are the likelihood of success, termination costs, and whether resources could be better used elsewhere.

The Project Manager

The project manager has many duties. In the planning stage, the project manager must prepare a scope statement that spells out the deliverables and goals, determine required skills and resources needed, develop a schedule and budget, and develop plans for managing the scope, the schedule, the budget, and quality and risk.

The project manager bears the ultimate responsibility for the success or failure of the project. He or she must be capable of working through others to accomplish the objectives of the project. The Project Management Institute (PMI) has developed a list of 10 areas of knowledge, called the Project Management Body of Knowledge (PMBOK), that a project manager should possess in order to effectively manage a project. They include the following:

1. **Managing integration:** This involves developing the scope statement, and the plan to direct, manage, and monitor the project, and control project changes.
2. **Managing scope:** This involves breaking down the scope and managing the project through a work breakdown structure.
3. **Managing time/schedule:** This involves definition, sequencing, resource and duration estimating, schedule development, and schedule control.
4. **Managing costs:** This involves resource planning, cost estimating, budgeting, and control.
5. **Managing quality:** This involves quality planning, quality assurance, and quality control.
6. **Managing human resources:** This involves human resources planning, hiring, and developing and managing a project team.
7. **Managing communication:** This involves communications planning, information distribution, performance reporting, and stakeholder management.
8. **Managing risk:** This involves risk planning and identification, risk analysis (qualitative and quantitative), risk response (action) planning, and risk monitoring and control.
9. **Managing procurement:** This involves acquisition and contracting plans, sellers’ responses and selections, contract administration, and contract closure.
10. **Managing stakeholders:** This involves identifying stakeholders, their interest level, and their potential to influence the project; and managing and controlling the relationships and communications between stakeholders and the project.

Several of these responsibilities are often portrayed in what is known as the “project management triangle.” The triangle illustrates the three interrelated constraints that will govern the project: cost (budget), schedule, and scope.

To effectively manage the project constraints, a project manager must employ a certain set of skills. The skills include the ability to motivate and direct team members; make trade-off decisions; expedite the work when necessary; put out fires; and monitor time, budget, and technical details. For projects that involve fairly well-defined work, those skills will often suffice. However, for projects that are less well defined, and thus have a higher degree of uncertainty, the project manager also must employ strong leadership skills. These include the ability to adapt to changing circumstances that may involve changes to project goals, technical requirements, and project team composition. As a leader, the project manager not only must be able to deal with these issues, he or she also must recognize the need for change, decide what changes are necessary, and then work to accomplish them.

The job of project manager can be both difficult and rewarding. The manager must coordinate and motivate people who sometimes owe their allegiance to other managers in the functional areas of their company, or other companies if they are involved in subcontracting. In addition, the people who work on a project frequently possess specialized knowledge and skills that the project manager lacks. Nevertheless, the manager is expected to guide and evaluate their efforts. Project managers often must function in an environment that is beset with uncertainties. Even so, budgets and time constraints are usually imposed, which can create additional pressures on project personnel. Finally, the project manager may not have the authority needed to accomplish all the objectives of the project. Instead, the manager sometimes must rely on persuasion and the cooperation of others to realize project goals.

Ethical issues often arise in connection with projects. Examples include the temptation to understate costs or to withhold information in order to get a project approved, pressure to alter or make misleading statements on status reports, falsifying records, compromising workers’ safety, and approving substandard work. It is the responsibility of managers at all levels to maintain and enforce ethical standards. Moreover, employees often take their cue from managers’ behavior, so it is doubly important for managers to be a model of ethical behavior. The Project Management Institute (PMI) has a website (www.pmi.org) that includes a code of ethics for project managers, in addition to other useful information about project management.

The position of project manager has high visibility. The rewards of the job of project manager come from the creative challenges of the job, the benefits of being associated with a successful project (including promotion and monetary compensation), and the personal satisfaction of seeing it through to its conclusion.

Behavioral Issues

Project metrics related to cost, schedule, and quality are important indicators of how well a project is doing. Behavioral metrics are also important and should not be overlooked. People make the project happen. However, behavioral issues can interfere with the success of a project if they are not carefully managed. Decentralized decision making, the stress of achieving project milestones on time and within budget, as well as surprises, can contribute to behavioral problems.

Because project work is often based on team efforts, workers are usually evaluated on the basis of the team’s overall contribution relative to project metrics, and not on an individual basis. The team must be able to function as a unit, so interpersonal skills are very important, as are coping skills. And conflict resolution can be an important part of a project manager’s job. Some problems can be avoided by the project manager via the following: by carefully selecting team members when possible; engaging in active leadership; by motivating employees; maintaining an environment of integrity, trust, and professionalism; and being supportive of team efforts.

The Project Management Triangle





ARTIFICIAL INTELLIGENCE WILL HELP PROJECT MANAGERS

BY LISA SPENCER

A new study by Gartner reports that by 2030, 80 percent of a typical project manager's tasks will be done via automation and artificial intelligence (AI). The technology promises benefits to companies and clients alike. Many believe that AI will make running projects more efficient in a way similar to how factories have been made more efficient by automation and other technology.

The study found that AI can collect, analyze, and report data much more quickly than humans. By conducting more routine tasks with greater speed and accuracy, AI software will help project managers improve overall results while decreasing errors and risk.

While AI will ultimately help project managers be more effective at their jobs, people will still be needed to perform "human" elements of projects, such as advising clients, exercising judgment

regarding project planning and problem solving, and leading project teams.

Questions

1. Will the AI technology render project managers unnecessary or obsolete?
2. Will using AI in project management mean fewer people have jobs?

Based on: "AI to Eliminate 80% of Project Management Tasks." IT Web, March 25, 2019, <https://www.itweb.co.za/content/wbrpOMgP103qDLZn>

Alexander, Moira. "Will AI Lead Project Managers to the Unemployment Line?" Tech Republic, March 28, 2019, <https://www.techrepublic.com/article/will-ai-lead-project-managers-to-the-unemployment-line/>

Project champion A person who promotes and supports a project.

Project Champions

Some companies make use of **project champions**. These are people, usually within the company, who promote and support the project. They can be instrumental in facilitating the work of the project manager by "talking up" the project to other managers who might be asked to share resources with the project team as well as employees who might be asked to work on parts of the project. The work a project champion does can be critical to the success of a project, so it is important for team members to encourage and communicate with the project champion.

Certification

The Project Management Institute (PMI) administers a globally recognized, examination-based professional certification program. The certification program maintains ISO 9001 certification in Quality Management Systems. There are two levels of certification: Associate and Project Management Professional. Candidates for the Associate and Professional levels must meet specific education and experience requirements and agree to adhere to a code of professional conduct. The Project Management Professional must demonstrate an ongoing professional commitment to the field of project management by satisfying PMI's Continuing Certification Requirements Program.¹

The Pros and Cons of Working on Projects

People are selected to work on special projects because the knowledge or abilities they possess are needed. In some instances, however, their supervisors may be reluctant to allow them to interrupt their regular jobs, even on a part-time basis, because it may require training a new person to do a job that will be temporary. Moreover, managers don't want to lose the output of good workers. The workers themselves are not always eager to participate in projects because it may mean working for two bosses who impose differing demands, it may disrupt friendships and daily routines, and it presents the risk of being replaced on the current job. Furthermore, there may be fear of being associated with an unsuccessful project because of the adverse effect it might have on career advancement. In too many instances, when a major project is phased out and the project team is disbanded, team members tend to drift away from the organization for lack of a new project and the difficulty of returning to former jobs. This tendency is more pronounced after lengthy projects and is less likely to occur when a team member works on a part-time basis.

In spite of the potential risks, people are attracted by the potential rewards of being involved in a project. One is the dynamic environment that surrounds a project, which is often

¹www.pmi.org.

in marked contrast to the staid environment of a routine in which some may feel trapped. Some individuals seem to thrive in more dynamic environments; they welcome the challenge of working under pressure and solving new problems. Then, too, projects may present opportunities to meet new people and to increase future job opportunities, especially if the project is successful. In addition, association with a project can be a source of status among fellow workers. Finally, working on projects frequently inspires a team spirit, increasing morale and motivation to achieve the successful completion of project goals.

17.4 WORK BREAKDOWN STRUCTURE

Because large projects usually involve a very large number of activities, planners need some way to determine exactly what will need to be done so they can realistically estimate how long it will take to complete the various elements of the project and how much it will cost. They often accomplish this by developing a **work breakdown structure (WBS)**, which is a hierarchical listing of what must be done during the project. This methodology establishes a logical framework for identifying the required activities for the project (see Figure 17.2). The first step in developing the work breakdown structure is to identify the major elements of the project. These are the Level 2 boxes in Figure 17.2. The next step is to identify the major supporting activities for each of the major elements—the Level 3 boxes. Then, each major supporting activity is broken down into a list of the activities that will be needed to accomplish it—the Level 4 boxes. (For purposes of illustration, only a portion of the Level 4 boxes are shown.) Usually, there are many activities in the Level 4 lists. Large projects involve additional levels, but Figure 17.2 gives you some idea of the concept of the work breakdown structure.

Developing a good work breakdown structure can require substantial time and effort due to the uncertainties associated with a project and/or the size of the project. Typically, the portion of time spent on developing the work breakdown structure greatly exceeds the time spent on actually developing a project schedule. The importance of a work breakdown structure is underscored by the fact that the activity list that results serves as the focal point for planning and doing the project. Moreover, the work breakdown structure is the basis for developing time and cost estimates.

LO17.4 Explain the nature and importance of a work breakdown structure in project management.

Work breakdown structure (WBS) A hierarchical listing of what must be done during a project.

17.5 PLANNING AND SCHEDULING WITH GANTT CHARTS

The Gantt chart (see Chapter 16) is a popular visual tool for planning and scheduling *simple* projects. It enables a manager to initially schedule project activities and then monitor

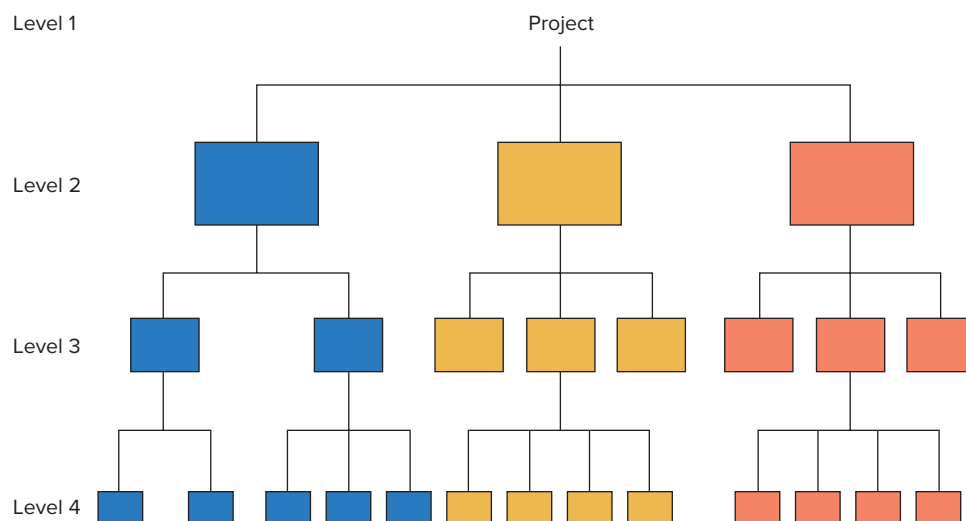
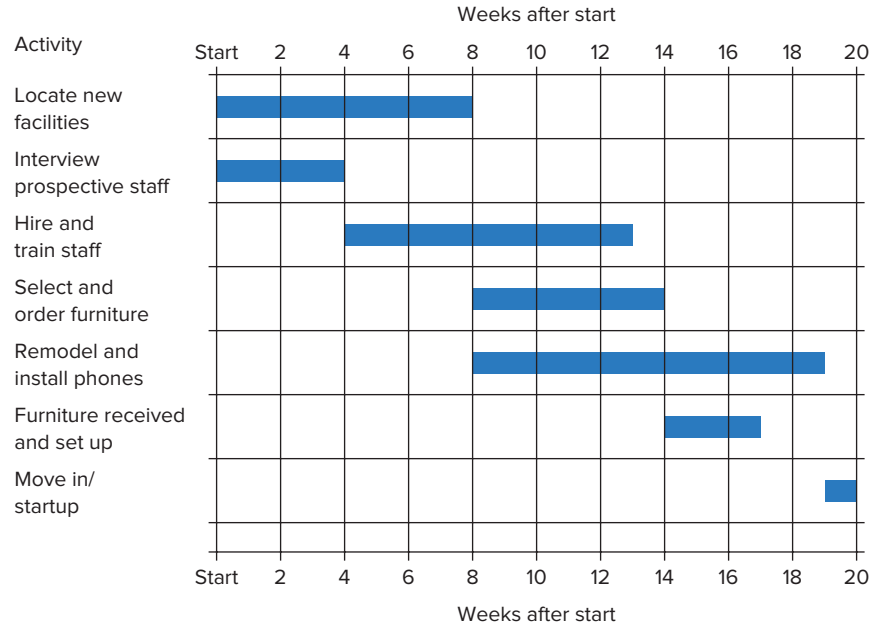

FIGURE 17.2
Schematic of a work breakdown structure

FIGURE 17.3

Gantt chart for bank example



their progress over time by comparing planned progress to actual progress. Figure 17.3 illustrates a Gantt chart for a bank's plan to establish a new direct marketing department. To prepare the chart, the vice president in charge of the project had to first identify the major activities that would be required. Next, time estimates for each activity were made, and the sequence of activities was determined. Once completed, the chart indicated which activities were to occur, their planned duration, and when they were to occur. Then, as the project progressed, the manager was able to see which activities were on schedule and which were behind schedule.

However, Gantt charts fail to reveal certain relationships among activities that can be crucial to effective project management. For instance, if one of the early activities in a project suffers a delay, it would be important for the manager to be able to easily determine which later activities would result in a delay. Conversely, some activities may safely be delayed without affecting the overall project schedule. The Gantt chart does not necessarily reveal this. On more complex projects, it is often used in conjunction with a *network diagram*, defined in the following section, for scheduling purposes.

17.6 PERT AND CPM

LO17.5 Give a general description of PERT/CPM techniques.

PERT Program evaluation and review technique, for planning and coordinating large projects.

CPM Critical path method, for planning and coordinating large projects.

PERT (program evaluation and review technique) and **CPM** (critical path method) are two of the most widely used techniques for planning and coordinating large-scale projects. By using PERT or CPM, managers are able to obtain:

- A graphical display of project activities
- An estimate of how long the project will take
- An indication of which activities are the most critical to timely project completion
- An indication of how long any activity can be delayed without delaying the project

Although PERT and CPM were developed independently, they have a great deal in common. Moreover, many of the initial differences between them have disappeared as users borrowed certain features from one technique for use with the other. For all practical purposes, the two techniques are now essentially the same. The comments and procedures described here will apply to both CPM analysis and PERT analysis of projects.

The Network Diagram

One of the main features of PERT and related techniques is their use of a **network** (or **precedence diagram**) to depict major project activities and their sequential relationships. There are two slightly different conventions for constructing these network diagrams. Under one convention, the *arrows* designate activities; under the other convention, the *nodes* designate activities. These conventions are referred to as **activity-on-arrow (AOA)** and **activity-on-node (AON)**. **Activities** consume resources and/or *time*. The nodes in the AOA approach represent the activities' starting and finishing points, which are called **events**. Events are points in time. Unlike activities, they consume neither resources nor time. The nodes in an AON diagram represent activities.

Both conventions are illustrated in Figure 17.4, using the bank example depicted in the Gantt chart in Figure 17.3. Compare the two. In the AOA diagram, the arrows represent activities and show the sequence in which certain activities must be performed (e.g., Interview precedes Hire and train); in the AON diagram, the arrows show only the sequence in which certain activities must be performed, while the nodes represent the activities. Activities in AOA networks can be referred to in either of two ways. One is by their endpoints (e.g., activity 2-4) and the other is by a letter assigned to an arrow (e.g., activity *c*). Both methods are illustrated in this chapter. Activities in AON networks are referred to by a letter (or number) assigned to a node. Although these two approaches are slightly different, they both show sequential relationships—something Gantt charts do not. Note that the AON diagram has a starting node, S, which is actually not an activity but is added to have a single starting node.

Despite these differences, the two conventions are remarkably similar, so you should not encounter much difficulty in understanding either one. In fact, there are convincing arguments for having some familiarity with *both* approaches. Perhaps the most compelling is that both approaches are widely used. Moreover, a contractor doing work for the organization may be using the other approach, so employees of the organization who deal with the contractor on project matters would benefit from knowledge of the other approach. However, any particular organization would typically use only one approach, and employees would have to work with that approach.

Of particular interest to managers are the *paths* in a network diagram. A **path** is a sequence of activities that leads from the starting node to the ending node. For example, in the AOA diagram, the sequence 1-2-4-5-6 is a path. In the AON diagram, S-1-2-6-7 is a path. Note that in both diagrams there are three paths. One reason for the importance of paths is that they reveal *sequential relationships*. The importance of sequential relationships cannot be overstated: If one activity in a sequence is delayed (i.e., late) or done incorrectly, the start of all following activities on that path will be delayed.

Another important aspect of paths is the length of a path: How long will a particular sequence of activities take to complete? The length (of time) of any path can be determined by summing the expected times of the activities on that path. The path with the longest time is of particular interest because it governs project completion time. In other words, expected project

Network (precedence) diagram Diagram of project activities that shows sequential relationships by use of arrows and nodes.

Activity-on-arrow (AOA) Network diagram convention in which arrows designate activities.

Activity-on-node (AON) Network diagram convention in which nodes designate activities.

Activities Project steps that consume resources and/or time.

Events The starting and finishing of activities, designated by nodes in the AOA convention.

Path A sequence of activities that leads from the starting node to the finishing node.

FIGURE 17.4 A simple project network diagram

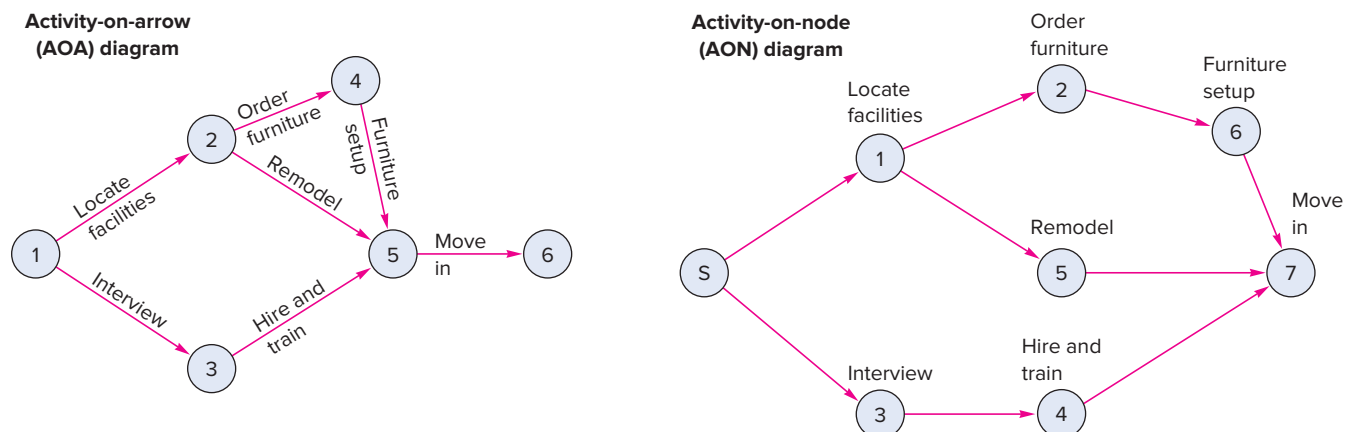

Critical path The longest path; determines expected project duration.

Critical activities Activities on the critical path.

Slack Allowable slippage for a path; the difference between the length of a path and the length of the critical path.

LO17.6 Construct simple network diagrams.

duration equals the expected time of the longest path. Moreover, if there are any delays along the longest path, there will be corresponding delays in project completion time. Attempts to shorten project completion must focus on the longest sequence of activities. Because of its influence on project completion time, the longest path is referred to as the **critical path**, and its activities are referred to as **critical activities**.

Paths that are shorter than the critical path can experience some delays and still not affect the overall project completion time, as long as the ultimate path time does not exceed the length of the critical path. The allowable slippage for any path is called **slack**, and it reflects the difference between the length of a given path and the length of the critical path. The critical path, then, has zero slack time.

Network Conventions

Developing and interpreting network diagrams requires some familiarity with networking conventions. Table 17.2 illustrates some of the most basic and common features of network diagrams, and gives sufficient background for understanding the basic concepts associated with precedence diagrams and lets you solve some typical problems.

A special feature that is sometimes used in AOA networks to clarify relationships is a *dummy activity*. In order to recognize the need to use a dummy activity using the AOA approach when presented with a list of activities and the activities each precedes, examine the “Immediate Predecessor” list. Look for instances where multiple activities are listed, such as *a, b* in the following list. If *a* or *b* appears separately in the list (as *b* does in the following table), a dummy will be needed to clarify the relationship (see the last diagram in Table 17.2).

Activity	Immediate Predecessor
a	—
b	—
c	a, b
d	b

Here are two more AOA conventions:

For reference purposes, nodes are numbered typically from left to right, with lower numbers assigned to preceding nodes and higher numbers to following nodes, as in the following.

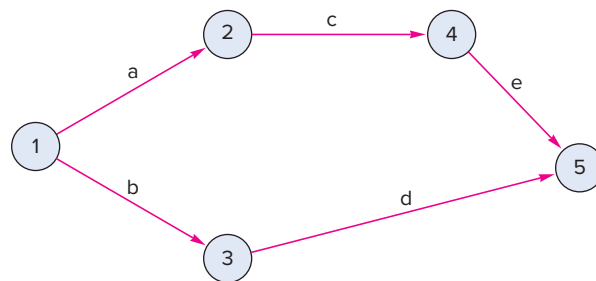

Starting and ending arrows are sometimes used during development of a network for increased clarity, as shown next.

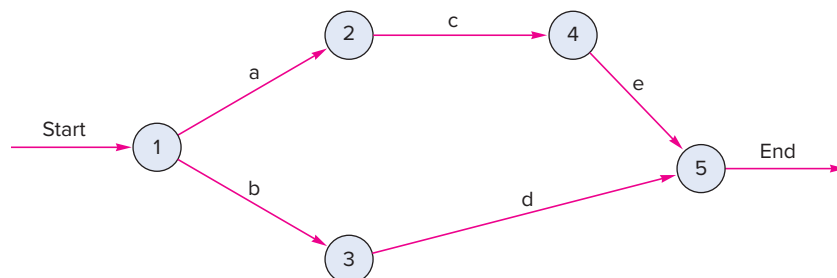
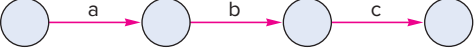
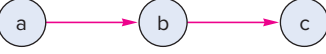
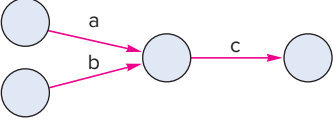
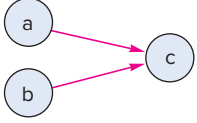
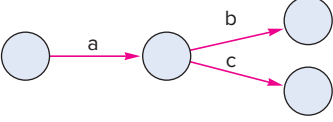
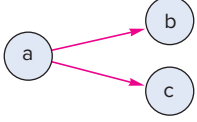
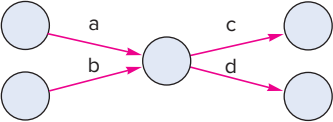
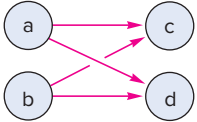
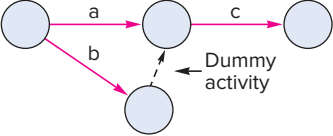
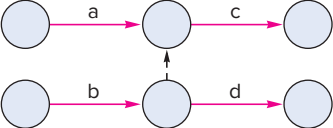

TABLE 17.2 Network conventions

AOA	Interpretation	AON
	Activities must be completed in sequence: first <i>a</i> , then <i>b</i> , and then <i>c</i> .	
	Both <i>a</i> and <i>b</i> must be completed before <i>c</i> can start. Note that activities <i>a</i> and <i>b</i> merge at activity <i>c</i> .	
	Activity <i>a</i> must be completed before <i>b</i> or <i>c</i> can start.	
	Both <i>a</i> and <i>b</i> must be completed before <i>c</i> or <i>d</i> can start.	
	Use a dummy activity to clarify relationships: 1. To separate two activities that have the same starting and ending nodes.	(No dummy needed)
	2. When activities share some, but not all, preceding activities. Here, activity <i>c</i> is preceded by activities <i>a</i> and <i>b</i> , while activity <i>d</i> is only preceded by activity <i>b</i> .	(No dummy needed)

17.7 DETERMINISTIC TIME ESTIMATES

The main determinant of the way PERT and CPM networks are analyzed and interpreted is whether activity time estimates are *probabilistic* or *deterministic*. If time estimates can be made with a high degree of confidence that actual times are fairly certain, we say the estimates are **deterministic**. If actual times are subject to variation, we say the estimates are **probabilistic**. Probabilistic time estimates must include an indication of the extent of probable variation.

This section describes analysis of networks with deterministic time estimates. A later section deals with probabilistic times.

One of the best ways to gain an understanding of the nature of network analysis is to consider a simple example.

LO17.7 Analyze networks with deterministic times.

Deterministic Time estimates that are fairly certain.

Probabilistic Estimates of times that allow for variation.

Identifying the Critical Path; Computing Project Duration and Slack Times for Deterministic Times

EXAMPLE 1

Given the additional information on the bank network of Figure 17.4 shown in Figure 17.5, determine the following.

- a. The length of each path
- b. The critical path
- c. The expected length of the project
- d. The amount of slack time for each path

FIGURE 17.5
AOA diagram

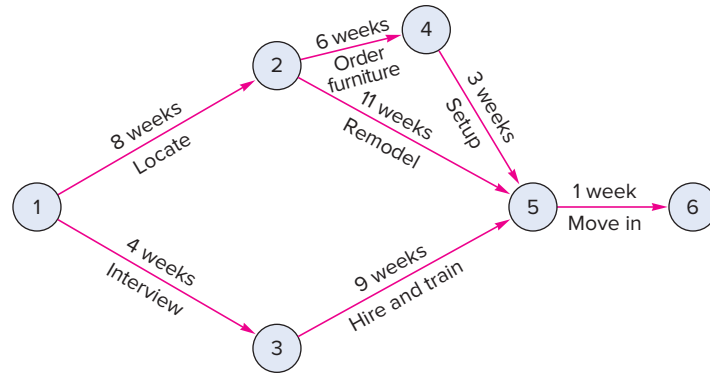

SOLUTION

- As shown in the following table, the path lengths are 18 weeks, 20 weeks, and 14 weeks.
- Path 1–2–5–6 is the longest path (20 weeks), so it is the critical path.
- The expected length of the project is equal to the length of the critical path (i.e., 20 weeks).
- We find the slack for each path by subtracting its length from the length of the critical path, as shown in the last column of the table. (*Note:* It is sometimes desirable to know the slack time associated with activities. The next section describes a method for obtaining those slack times.)

Path	Length (weeks)	Slack
1–2–4–5–6	$8 + 6 + 3 + 1 = 18$	$20 - 18 = 2$
1–2–5–6	$8 + 11 + 1 = 20^*$	$20 - 20 = 0$
1–3–5–6	$4 + 9 + 1 = 14$	$20 - 14 = 6$

*Critical path length

17.8 A COMPUTING ALGORITHM

Many real-life project networks are much larger than the simple network illustrated in the preceding example; they often contain hundreds or even thousands of activities. Because the necessary computations can become exceedingly complex and time-consuming, large networks are generally analyzed by computer programs instead of manually. Planners use an algorithm to develop four pieces of information about the network activities:

ES, the earliest time activity can start, assuming all preceding activities at their earliest finish time.

EF, the earliest time the activity can finish.

LS, the latest time the activity can start and not delay the project.

LF, the latest time the activity can finish and not delay the project.

Once these values have been determined, they can be used to find:

- Expected project duration
- Slack time
- The critical path

Activity-on-Arrow

The three examples that follow illustrate how to compute those values using the precedence diagram of Example 1.

Computing Earliest Starting and Finishing Times

EXAMPLE 2

Compute the earliest starting time and earliest finishing time for each activity in the diagram shown in Figure 17.5.



SOLUTION

Begin by placing brackets at the two ends of each starting activity:



We want to determine and place in the brackets for each activity the earliest starting time, ES, and the earliest finishing time, EF, for every activity, and put them in brackets, as follows:



Do this for all activities, beginning at the left side of the precedence diagram and moving to the right side.

Once ES has been determined for each activity, EF can be found by adding the activity time, t , to ES: $ES + t = EF$.

Use an ES of 0 for all starting activities. Thus, activities 1-2 and 1-3 are assigned ES values of 0. This permits computation of the EF for each of these activities:

$$EF_{1,2} = 0 + 8 = 8 \text{ and } EF_{1,3} = 0 + 4 = 4$$

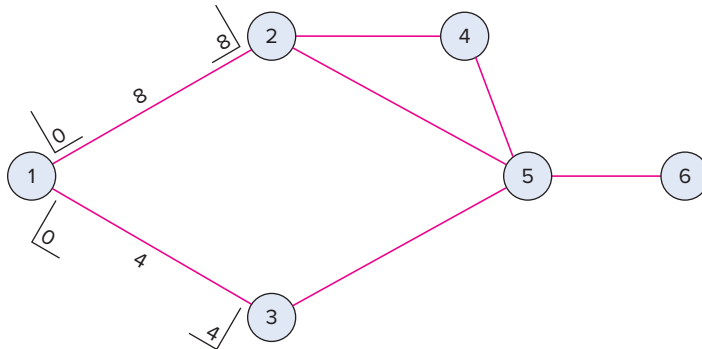

The EF time for an activity becomes the ES time for the next activity to follow it in the diagram. Hence, because activity 1-2 has an EF time of 8, both activities 2-4 and 2-5 have ES times of 8. Similarly, activity 3-5 has an ES time of 4.

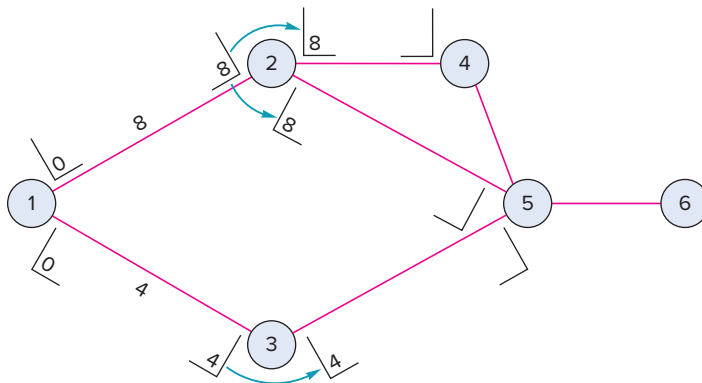

This permits calculation of the EF times for these activities: $EF_{2,4} = 8 + 6 = 14$; $EF_{2,5} = 8 + 11 = 19$; and $EF_{3,5} = 4 + 9 = 13$.

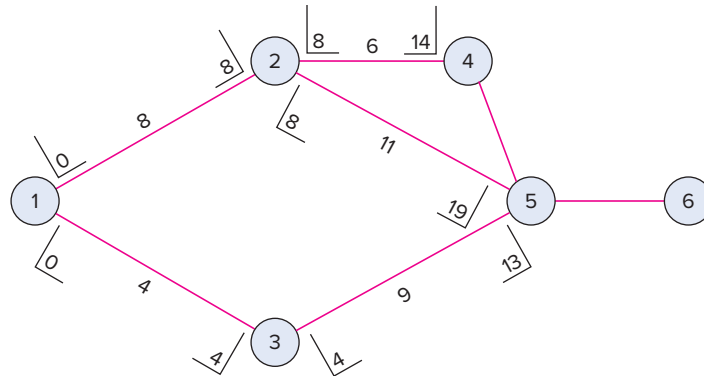

The ES for activity 4-5 is the EF time of activity 2-4, which is 14. Using this value, we find the EF for activity 4-5 is 17; $EF_{4,5} = 14 + 3 = 17$.

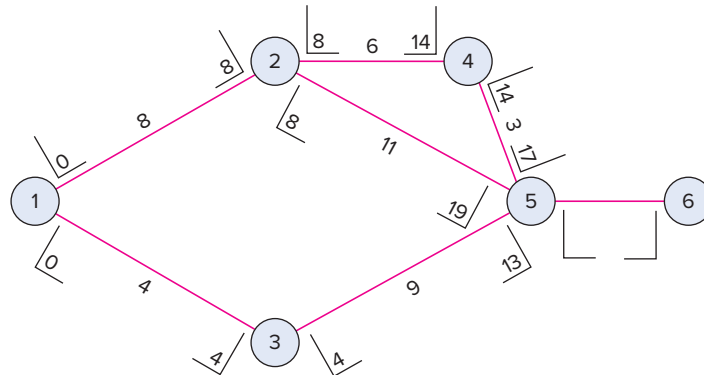

In order to determine the ES for activity 5-6, we must realize that activity 5-6 cannot start until *every* activity that precedes it is finished. Therefore, the *largest* of the EF times for the three activities that precede activity 5-6 determines $ES_{5,6}$. Hence, the ES for activity 5-6 is 19.

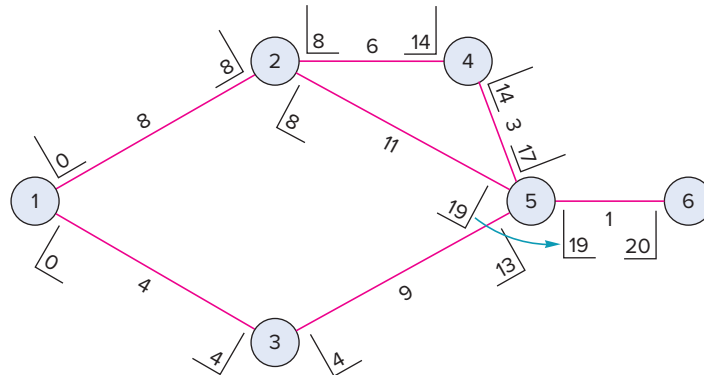

Then, the EF for the last activity, 5-6, is 20; $EF_{5,6} = 19 + 1 = 20$. Note that the latest EF is the project duration. Thus, the expected length of the project is 20 weeks.

Computation of earliest starting and finishing times is aided by two simple rules:

1. The earliest finish time for any activity is equal to its earliest start time plus its expected duration, t :

$$EF = ES + t \quad (17-1)$$
2. ES for activities at nodes with one entering arrow is equal to EF of the entering arrow. ES for activities leaving nodes with multiple entering arrows is equal to the largest EF of the entering arrow.

Computation of the latest starting and finishing times is aided by the use of two rules:

1. The latest starting time for each activity is equal to its latest finishing time minus its expected duration:

$$EF = ES - t \tag{17-2}$$

2. For nodes with one leaving arrow, LF for arrows entering that node equals the LS of the leaving arrow. For nodes with multiple leaving arrows, LF for arrows entering that node equals the smallest LS of leaving arrows.

Finding ES and EF times involves a *forward pass* through the network; finding LS and LF times involves a *backward pass* through the network. Hence, we must begin with the EF of the last activity and use that time as the LF for the last activity. Then, we obtain the LS for the last activity by subtracting its expected duration from its LF.

RULES FOR THE COMPUTING ALGORITHM

(Note: For an AON diagram, if a starting node or ending node does not have a time associated with it, ignore that node.)

Forward Pass

For each path, start at the left side of the diagram and work toward the right side.

For each beginning activity: $ES = 0$.

For each activity: $ES + \text{Activity time} = EF$.

For the following activity: $ES = EF$ of the preceding activity.

Note: If an activity has multiple immediate preceding activities, set its ES equal to the largest EF of its immediate predecessors.

Backward Pass

For each path, start at the right side of the diagram and work toward the left side.

Use the largest EF as the LF for all ending activities.

For each activity: $LS = LF - \text{Activity time}$.

For the preceding activity: $LF = LS$ of the following activity.

Note: If an activity has multiple immediately following activities, set the activity's LF equal to the smallest LS of the following activities.

Computing the Latest Finishing and Starting Times

Compute the latest finishing and starting times for the precedence diagram developed in Example 2.

EXAMPLE 3

excel
mhhe.com/stevenson14e

We must add the LS and LF times to the brackets on the diagram.



Begin by setting the LF time of the last activity equal to the EF of that activity. Thus,

$$LF_{5-6} = EF_{5-6} = 20 \text{ weeks}$$

Obtain the LS time for activity 5-6 by subtracting the activity time, t , from the LF time:

$$LS_{5-6} = LF_{5-6} - t = 20 - 1 = 19$$

Mark these values on the diagram:

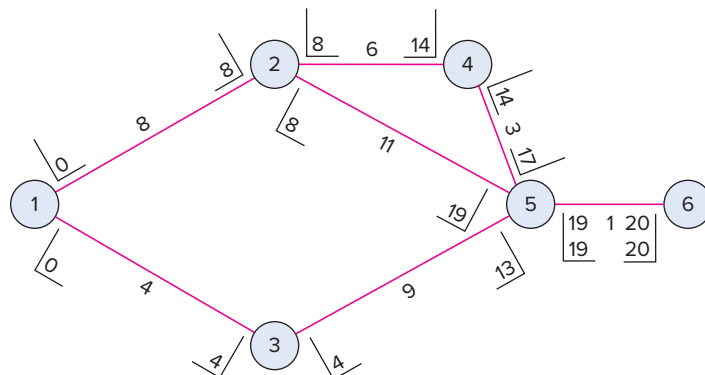

SOLUTION

The LS time of 19 for activity 5-6 now becomes the LF time for each of the activities that precedes activity 5-6. This permits determination of the LS times for each of those activities: Subtract the activity time from the LF to obtain the LS time for the activity. The LS time for activity 3-5 is $19 - 9 = 10$.

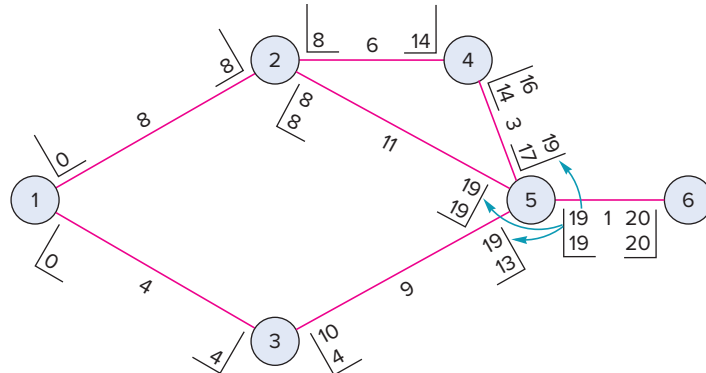

Next, the LS for activity 4-5, which is 16, becomes the LF for activity 2-4, and the LS for activity 3-5, which is 10, becomes the LF for activity 1-3. Using these values, you find the LS for each of these activities by subtracting the activity time from the LF time.

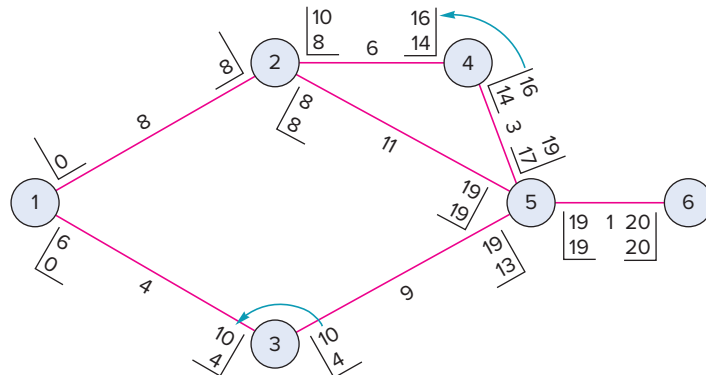

The LF for activity 1-2 is the *smaller* of the two LS times of the activities that 1-2 precedes. Hence, the LF time for activity 1-2 is 8. The reason you use the smaller time is that activity 1-2 must finish at a time that permits all following activities to start no later than their LS times.

Once you have determined the LF time of activity 1-2, find its LS time by subtracting the activity time of 8 from the LF time of 8. Hence, the LS time is 0.

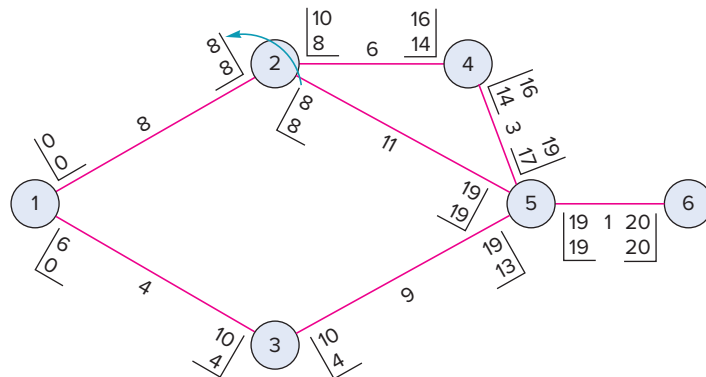

Activity-on-Node

The computing algorithm is performed in essentially the same manner in the AON approach. Figure 17.6 shows the node diagram, and Figures 17.7A, B, and C illustrate the computing algorithm.

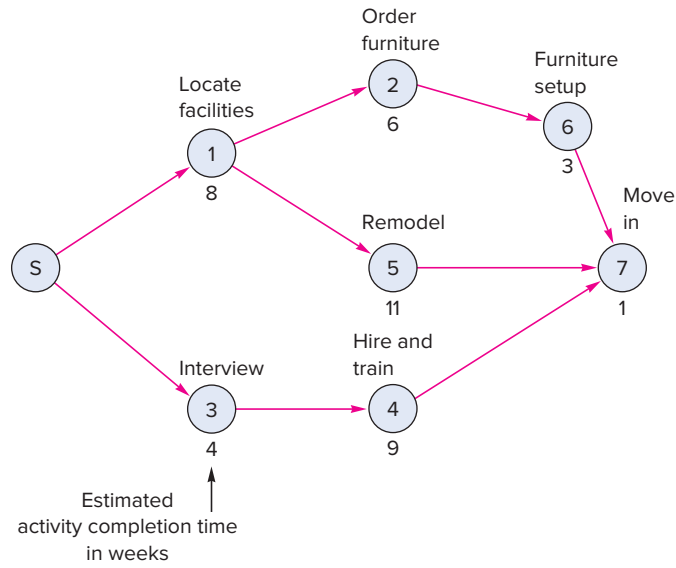

FIGURE 17.6
AON diagram

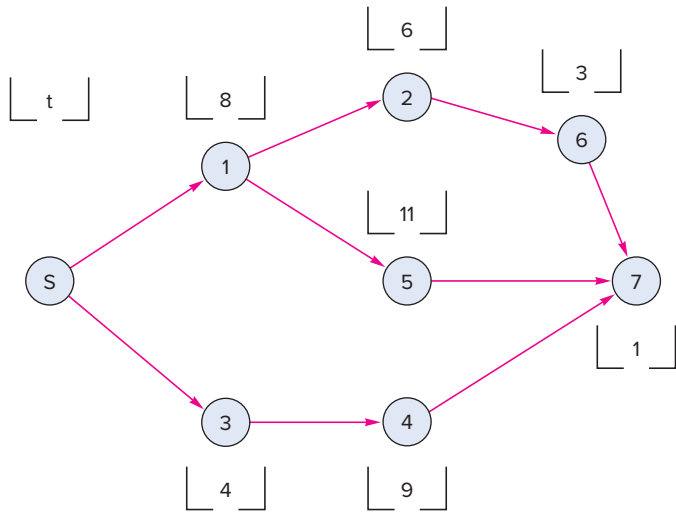

FIGURE 17.7A
AON diagram with brackets added

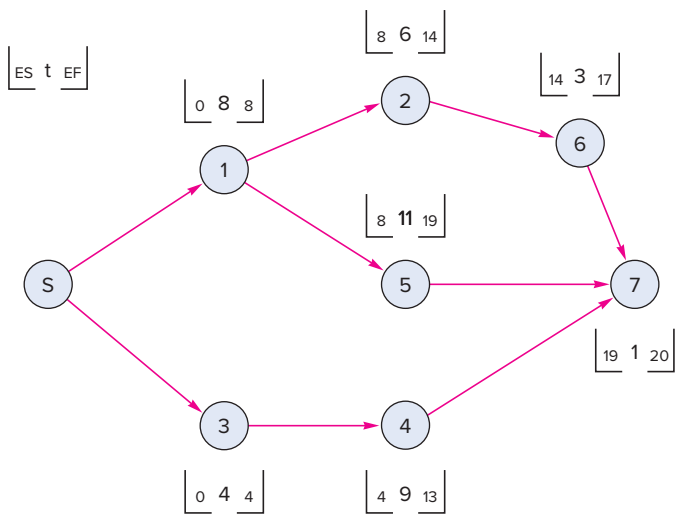
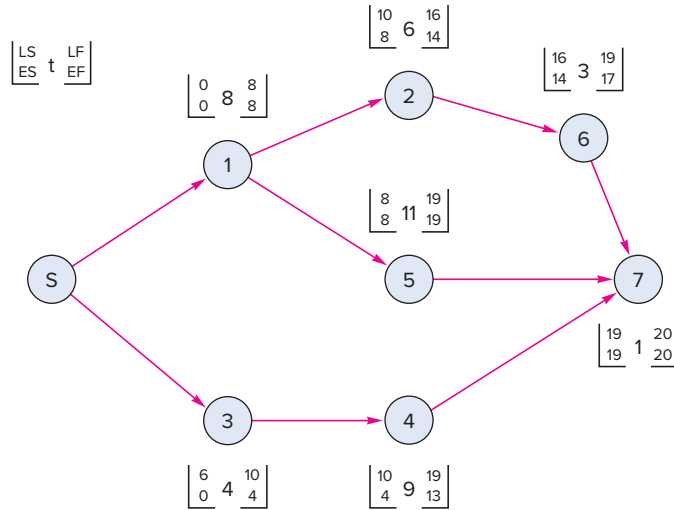

FIGURE 17.7B
Forward pass

FIGURE 17.7C
Backward pass



Computing Slack Times

The slack time can be computed in either of two ways:

$$\text{Slack} = \text{LS} - \text{ES} \text{ or } \text{LF} - \text{EF} \tag{17-3}$$

The critical path using this computing algorithm is denoted by activities with zero slack time. Thus, the table in Example 4 indicates that activities 1-2, 2-5, and 5-6 are all critical activities, which agrees with the results of the intuitive approach demonstrated in Example 1.

Knowledge of slack times provides managers with information for planning the allocation of scarce resources and for directing control efforts toward those activities that might be most susceptible to delaying the project. In this regard, it is important to recognize that the activity slack times are based on the assumption that all of the activities on the same path will be started as early as possible and not exceed their expected times. Furthermore, if two activities are both on the same path (e.g., activities 2-4 and 4-5 in the preceding example) and have the same slack (e.g., two weeks), this will be the *total* slack available to both. In essence, the activities have *shared slack*. Hence, if the first activity uses all the slack, there will be zero slack for all following activities on that same path.

EXAMPLE 4

Computing Slack Times



mhhe.com/stevenson14e

Compute slack times for the preceding example.

SOLUTION

Either the starting times or the finishing times can be used. Suppose we choose the starting times. Using ES times computed in Example 2 and LS times computed in Example 3, slack times are:

Activity	LS	ES	(LS – ES) Slack
1-2	0	0	0
1-3	6	0	6
2-4	10	8	2
2-5	8	8	0
3-5	10	4	6
4-5	16	14	2
5-6	19	19	0

Activities that have a slack of zero are on the critical path. Hence, the critical path is 1–2–5–6.

As noted earlier, this algorithm lends itself to computerization. A computer printout for this problem would appear something like the one shown in Table 17.3.

Activity	Time	SCHEDULE				Slack
		EARLY		LATE		
		ES	EF	LS	LF	
1-2	8.00	0.00	8.00	0.00	8.00	0.00
1-3	4.00	0.00	4.00	6.00	10.00	6.00
2-4	6.00	8.00	14.00	10.00	16.00	2.00
2-5	11.00	8.00	19.00	8.00	19.00	0.00
3-5	9.00	4.00	13.00	10.00	19.00	6.00
4-5	3.00	14.00	17.00	16.00	19.00	2.00
5-6	1.00	19.00	20.00	19.00	20.00	0.00

THE CRITICAL PATH SEQUENCE IS:

SNODE	FNODE	TIME
1	2	8.00
2	5	11.00
5	6	1.00
		20.00

TABLE 17.3
Computer printout

17.9 PROBABILISTIC TIME ESTIMATES

The preceding discussion assumed that activity times were known and not subject to variation. While that condition exists in some situations, there are many others where it does not. Consequently, those situations require a probabilistic approach.

The probabilistic approach involves *three* time estimates for each activity instead of one, shown next:

- **Optimistic time:** The length of time required under optimum conditions; represented by t_o
- **Pessimistic time:** The length of time required under the worst conditions; represented by t_p
- **Most likely time:** The most probable amount of time required; represented by t_m

Managers or others with knowledge about the project can make these time estimates.

The **beta distribution** is generally used to describe the inherent variability in time estimates (see Figure 17.8). Although there is no real theoretical justification for using the beta distribution, it has certain features that make it attractive in practice: The distribution can be symmetrical or skewed to either the right or the left according to the nature of a particular activity; the mean and variance of the distribution can be readily obtained from the three time estimates listed above; and the distribution is unimodal, with a high concentration of probability surrounding the most likely time estimate.

Of special interest in network analysis are the average or expected time for each activity, t_e , and the variance of each activity time, σ^2 . The expected time of an activity, t_e , is a weighted average of the three time estimates:

$$t_e = \frac{t_o + 4t_m + t_p}{6} \tag{17-4}$$

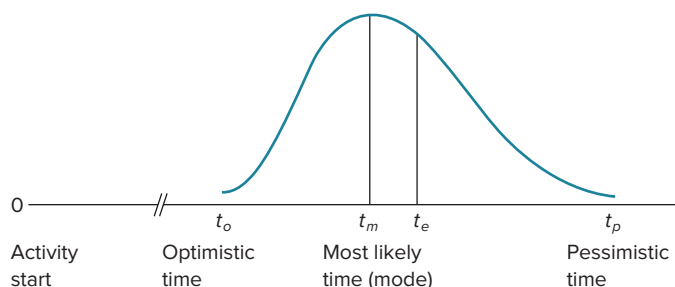

LO17.8 Analyze networks with probabilistic times.

Optimistic time The length of time required under optimal conditions.

Pessimistic time The length of time required under the worst conditions.

Most likely time The most probable length of time that will be required.

Beta distribution Used to describe the inherent variability in activity time estimates.

FIGURE 17.8

A beta distribution is used to describe probabilistic time estimates

The expected duration of a path (i.e., the path mean) is equal to the sum of the expected times of the activities on that path:

$$\text{Path mean} = \sum \text{of expected times of activities on the path} \tag{17-5}$$

The standard deviation of each activity's time is estimated as one-sixth of the difference between the pessimistic and optimistic time estimates. (Analogously, nearly all of the area under a normal distribution lies within three standard deviations of the mean, which is a range of six standard deviations.) We find the variance by squaring the standard deviation. Thus,

$$\sigma^2 = \left[\frac{(t_p - t_o)}{6} \right]^2 \text{ or } \frac{(t_p - t_o)^2}{36} \tag{17-6}$$

The size of the variance reflects the degree of uncertainty associated with an activity's time: the larger the variance, the greater the uncertainty.

It is also desirable to compute the standard deviation of the expected time for *each path*. We can do this by summing the variances of the activities on a path and then taking the square root of that number; that is,

$$\sigma_{\text{path}} = \sqrt{\sum (\text{Variances of activities on path})} \tag{17-7}$$

Example 5 illustrates these computations.

EXAMPLE 5



Computing Expected Activity Times and Variances, and the Expected Duration and Standard Deviation of Each Path

The network diagram for a project is shown in the accompanying figure, with three time estimates for each activity. Activity times are in weeks. Do the following:

- Compute the expected time for each activity and the expected duration for each path.
- Identify the critical path.
- Compute the variance of each activity and the variance and standard deviation of each path.

AOA diagram

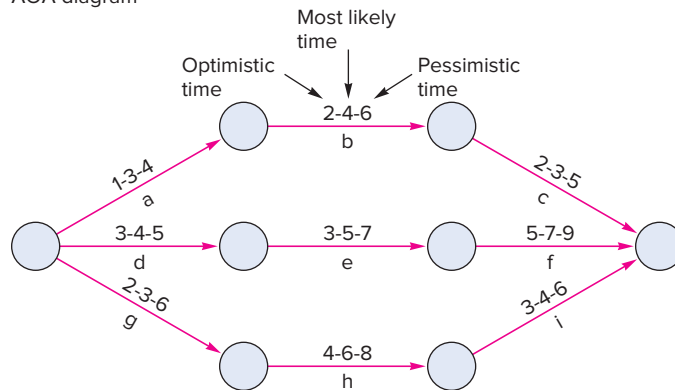

AON diagram

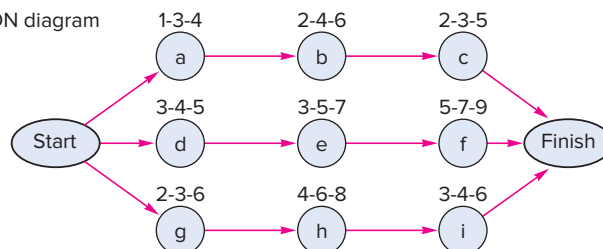

SOLUTION

a.

Path	Activity	TIMES			$t_e = \frac{t_o + 4t_m + t_p}{6}$	Path Total
		t_o	t_m	t_p		
a-b-c	a	1	3	4	2.83	10.00
	b	2	4	6	4.00	
	c	2	3	5	3.17	
d-e-f	d	3	4	5	4.00	16.00
	e	3	5	7	5.00	
	f	5	7	9	7.00	
g-h-i	g	2	3	6	3.33	13.50
	h	4	6	8	6.00	
	i	3	4	6	4.17	

b. The path that has the longest expected duration is the critical path. Because path d-e-f has the largest path total, it is the critical path.

c.

Path	Activity	TIMES			$\sigma^2_{act} = \frac{(t_p - t_o)^2}{36}$	σ^2_{path}	σ_{path}
		t_o	t_m	t_p			
a-b-c	a	1	3	4	$(4 - 1)^2/36 = 9/36$	34/36 = 0.944	0.97
	b	2	4	6	$(6 - 2)^2/36 = 16/36$		
	c	2	3	5	$(5 - 2)^2/36 = 9/36$		
d-e-f	d	3	4	5	$(5 - 3)^2/36 = 4/36$	36/36 = 1.00	1.00
	e	3	5	7	$(7 - 3)^2/36 = 16/36$		
	f	5	7	9	$(9 - 5)^2/36 = 16/36$		
g-h-i	g	2	3	6	$(6 - 2)^2/36 = 16/36$	41/36 = 1.139	1.07
	h	4	6	8	$(8 - 4)^2/36 = 16/36$		
	i	3	4	6	$(6 - 3)^2/36 = 9/36$		

Knowledge of the expected path times and their standard deviations enables a manager to compute probabilistic estimates of the project completion time, such as these:

The probability that the project will be completed by a specified time.

The probability that the project will take longer than its scheduled completion time.

These estimates can be derived from the probability that various paths will be completed by the specified time. This involves the use of the normal distribution. Although activity times are represented by a beta distribution, the path distribution is represented by a normal distribution. The central limit theorem tells us that the summing of activity times (random variables) results in a normal distribution. This is illustrated in Figure 17.9. The rationale for using a normal distribution is that sums of random variables (activity times or means) will tend to be normally distributed, regardless of the distributions of the variables. The normal tendency improves as the number of random variables increases. However, even when the number of items being summed is fairly small, the normal approximation provides a reasonable approximation to the actual distribution.

FIGURE 17.9 Activity distributions and the path distribution

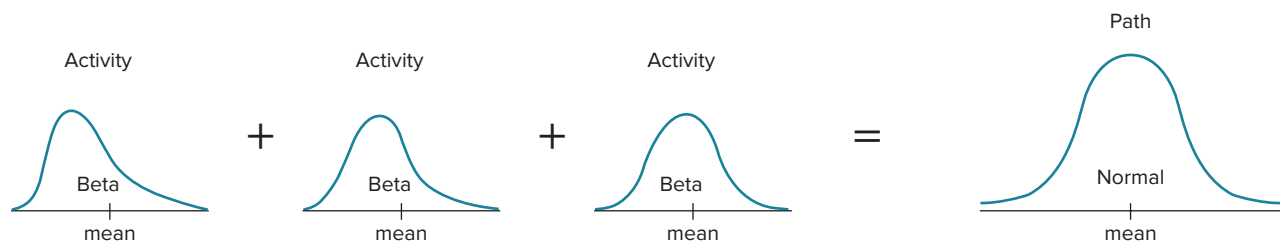

17.10 DETERMINING PATH PROBABILITIES

The probability that a given path will be completed in a specified length of time can be determined using the following formula:

$$z = \frac{\text{Specified time} - \text{Path mean}}{\text{Path standard deviation}} \quad (17-8)$$

The resulting value of z indicates how many standard deviations of the path distribution the specified time is beyond the expected path duration. The more positive the value, the better. (A negative value of z indicates that the specified time is *earlier* than the expected path duration.) Once the value of z has been determined, it can be used to obtain the probability that the path will be completed by the specified time from Appendix B, Table B. Note that the probability is equal to the area under the normal curve to the left of z , as illustrated in Figure 17.10.

If the value of z is +3.00 or more, the path probability is close to 100 percent (for $z = +3.00$, it is .9987). Hence, it is very likely the activities that make up the path will be completed by the specified time. For that reason, a useful rule of thumb is to treat the path probability as being equal to 100 percent if the value of z is +3.00 or more.

Rule of thumb: If the value of z is +3.00 or more, treat the probability of path completion by the specified time as 100 percent.

A project is not completed until *all* of its activities have been completed, not only those on the critical path. It sometimes happens that another path ends up taking more time to complete than the critical path, in which case the project runs longer than expected. Hence, it can be risky to focus exclusively on the critical path. Instead, one must consider the possibility that at least one other path will delay timely project completion. This requires determining the probability that *all* paths will finish by a specified time. To do that, find the probability that each path will finish by the specified time, and then multiply those probabilities. The result is the probability that the *project* will be completed by the specified time.

It is important to note the assumption of **independence**. It is assumed that path duration times are independent of each other. In essence, this requires two things: Activity times are independent of each other, and each activity is only on one path. For activity times to be independent, the time for one must not be a function of the time of another; if two activities were always early or late together, they would not be considered independent. The assumption of independent *paths* is usually considered to be met if only a *few* activities in a large project are on multiple paths. Even then, common sense should govern the decision of whether the independence assumption is justified.

Independence Assumption that path duration times are independent of each other; requiring that activity times be independent, and that each activity is on only one path.

FIGURE 17.10

The path probability is the area under a normal curve to the left of z

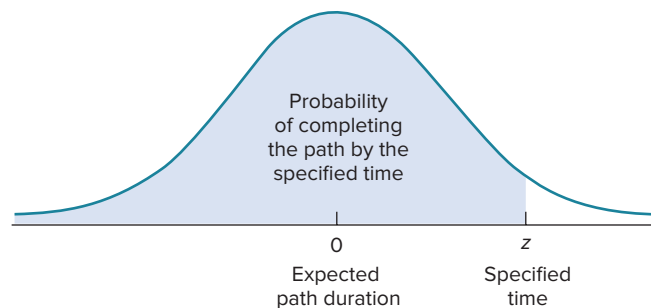

EXAMPLE 6

Excel

mhhe.com/stevenson14e

Computing the Probability That a Project Will and Will Not Be Completed by a Specified Time

Using the information from Example 5, answer the following questions:

- Can the paths be considered independent? Why?
- What is the probability that the project can be completed within 17 weeks of its start?
- What is the probability that the project will be completed within 15 weeks of its start?
- What is the probability that the project will *not* be completed within 15 weeks of its start?

SOLUTION

- a. Yes, the paths can be considered independent, because no activity is on more than one path and you have no information suggesting that any activity times are interrelated.
- b. To answer questions of this nature, you must take into account the degree to which the path distributions “overlap” the specified completion time. This overlap concept is illustrated in the accompanying figure, which shows the three path distributions, each centered on that path’s expected duration, and the specified completion time of 17 weeks. The shaded portion of each distribution corresponds to the probability that the part will be completed within the specified time. Observe that paths a–b–c and g–h–i are well enough to the left of the specified time, so that it is highly likely that both will be finished by week 17, but the critical path overlaps the specified completion time. In such cases, you need consider only the distribution of path d–e–f in assessing the probability of completion by week 17.

To find the probability for a path, you must first compute the value of z using Formula 17–8 for the path. For example, for path d–e–f, we have:

$$z = \frac{17 - 16}{1.00} = +1.00$$

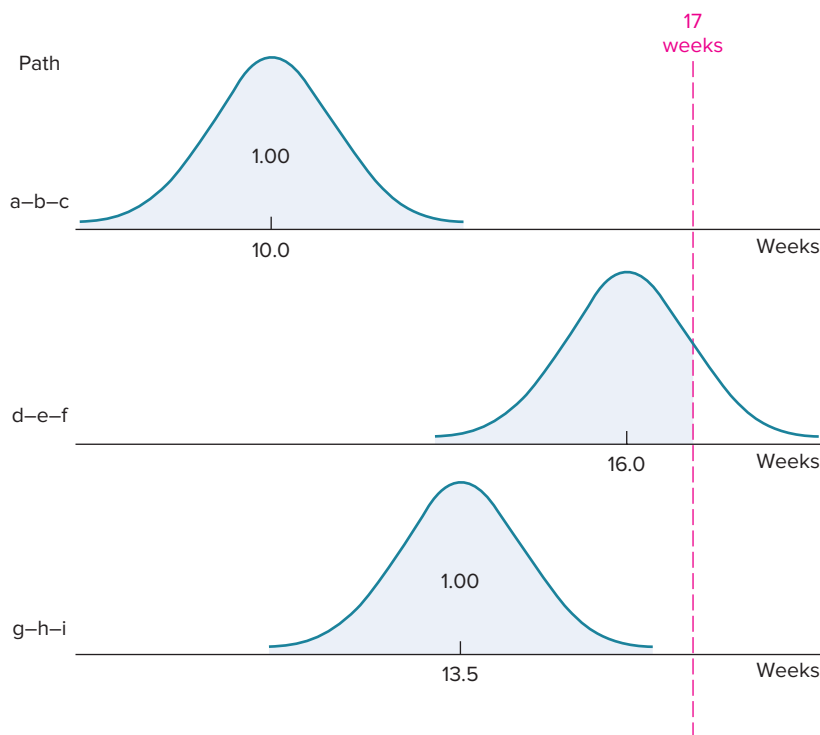

Turning to Appendix B, Table B, with $z = +1.00$, you will find that the area under the curve to the left of z is .8413. The computations are summarized in the following table. *Note:* If the value of z exceeds +3.00, treat the probability of completion as being equal to 1.000.

Path	$z = \frac{17 - \text{Expected path duration}}{\text{Path standard deviation}}$	Probability of Completion in 17 Weeks
a-b-c	$\frac{17 - 10}{0.97} = +7.22$	1.00
d-e-f	$\frac{17 - 16}{1.00} = +1.00$.8413
g-h-i	$\frac{17 - 13.5}{1.07} = +3.27$	1.00

$$P(\text{Finish by week 17}) = P(\text{Path a-b-c finish}) \times P(\text{Path d-e-f finish}) \times P(\text{Path g-h-i finish}) \\ = 1.00 \times .8413 \times 1.00 = .8413$$

c. For a specified time of 15 weeks, the z values are

Path	$z = \frac{15 - \text{Expected path duration}}{\text{Path standard deviation}}$	Probability of Completion in 15 Weeks
a-b-c	$\frac{15 - 10.00}{.97} = +5.15$	1.00
d-e-f	$\frac{15 - 16.00}{1.00} = -1.00$.1587
g-h-i	$\frac{15 - 13.50}{1.07} = +1.40$.9192

Paths d-e-f and g-h-i have z values that are less than +3.00.

From Appendix B, Table B, the area to the *left* of $z = -1.00$ is .1587, and the area to the *left* of $z = +1.40$ is .9192. The path distributions are illustrated in the figure. The joint probability of all finishing before week 15 is the product of their probabilities: $1.00(.1587)(.9192) = .1459$.

d. The probability of not finishing before week 15 is the complement of the probability obtained in part c: $1 - .1459 = .8541$.

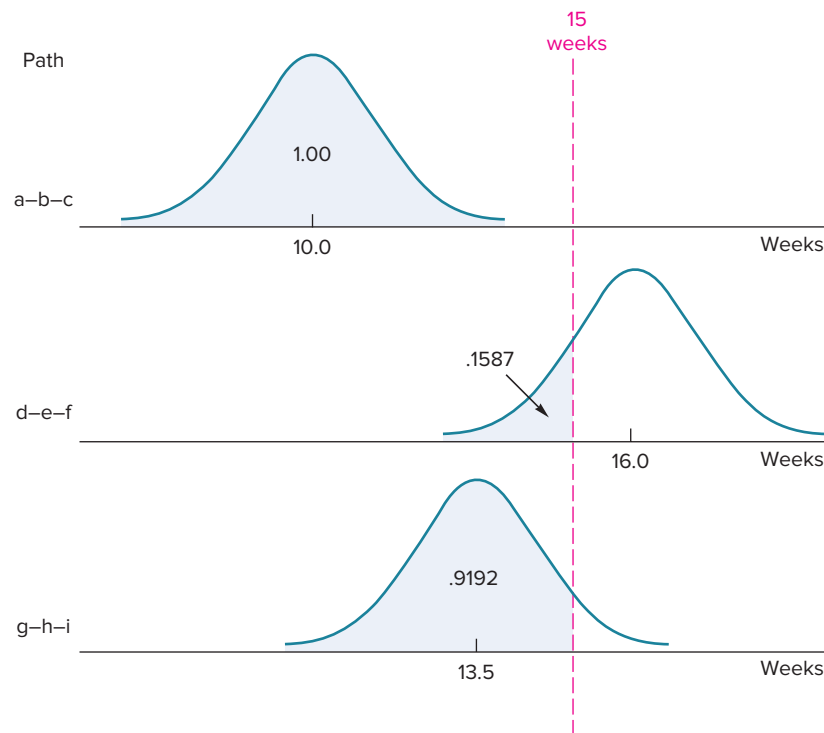

17.11 SIMULATION

We have examined a method for computing the probability that a project would be completed in a specified length of time. That discussion assumed that the paths of the project were *independent*; that is, the same activities are not on more than one path. If an activity were on more than one path, and it happened that the completion time for that activity far exceeded its expected time, all paths that included that activity would be affected and, hence, their times would not be independent. Where activities are on multiple paths, one must consider if the

preceding approach can be used. For instance, if only a few activities are on multiple paths, particularly if the paths are *much* shorter than the critical path, that approach may still be reasonable. Moreover, for purposes of illustration, as in the text problems and examples, the paths are treated as being independent when, in fact, they may not be.

In practice, when *dependent* cases occur, project planners often use *simulation*. It amounts to a form of repeated sampling wherein many passes are made through the project network. In each pass, a randomly selected value for each activity time is made based on the characteristics of the activity's probability distribution (e.g., its mean, standard deviation, and distribution type). After each pass, the expected project duration is determined by adding the times along each path and designating the time of the longest path as the project duration. After a large number of such passes (e.g., several hundred), there is enough information to prepare a frequency distribution of the project duration times. Planners can use this distribution to make a probabilistic assessment of the actual project duration, allowing for some activities that are on more than one path. Problem 19 in the simulation supplement to Chapter 18 located on the text website illustrates this.

17.12 BUDGET CONTROL

Budget control is a critical aspect of a project. Costs can exceed budget for a number of reasons, and unless corrective action is taken, serious cost overruns can occur, possibly putting the project in jeopardy. Cost overruns can occur for various reasons. One possibility is that initial estimates might have been overly optimistic. Another is that unforeseen events such as weather or supplier issues, substandard work or parts that had to be remedied, or some other event, added costs.

Table 17.4 illustrates the project cost status for a hypothetical project that is in progress. For this project, the first three activities have been completed. Activity A was \$1,000 under budget, Activity B was right at its budgeted amount, and Activity C was overbudget by \$3,500. The remaining activities are incomplete, but each has a projected cost and a projected difference. Unless there is a change during the remaining life of the project, the cost overrun is projected to be \$4,000. The project manager will have to decide if that amount is acceptable, or whether corrective action should be initiated. Although managers' inclinations may be to focus on the activities that are overbudget, they would likely review all activities to see where potential savings are possible. Of course, the project cost status would be updated, usually on a daily or weekly basis, to keep the project manager informed.

17.13 TIME-COST TRADE-OFFS: CRASHING

Estimates of activity times for projects usually are made for some given level of resources. In many situations, it is possible to reduce the length of a project by injecting additional resources. The impetus to shorten projects may reflect efforts to avoid late penalties, to take advantage of

LO17.9 Describe activity "crashing" and solve typical problems.

Activity	Budgeted Cost	Percent Complete	Actual or Projected Cost	(Over/Under) Actual—Budget
A	\$25,000	100%	\$24,000	\$1,000
B	15,000	100	15,000	0
C	22,000	100	25,500	−3,500
D	10,000	75	10,500	−500
E	30,000	50	29,000	1,000
F	20,000	40	22,000	−2,000
G	8,000	25	8,000	0
				−\$4,000

TABLE 17.4
Project cost status for a hypothetical project

Workers demolish the south side of the Mulholland overpass on the 405 freeway during the 53-hour total freeway closure. The bridge was demolished as part of a \$1 billion project to add carpool lanes and to make other improvements along the route from Orange County to San Francisco.



David McNew/Getty Images

Crash Shortening activity durations.

monetary incentives for timely or early completion of a project, or to free resources for use on other projects. In new product development, shortening may lead to a strategic benefit: beating the competition to the market. In some cases, however, the desire to shorten the length of a project merely reflects an attempt to reduce the costs associated with running the project, such as facilities and equipment costs, supervision, and labor and personnel costs. Managers often have various options at their disposal that will allow them to shorten, or **crash**, certain activities. Among the most obvious options are the use of additional funds to support additional personnel or more efficient equipment, and the relaxing of some work specifications. Hence, a project manager may be able to shorten a project by increasing *direct* expenses to speed up the project, thereby realizing savings on indirect project costs. The goal in evaluating time–cost trade-offs is to identify activities that will reduce the sum of the project costs.

In order to make a rational decision on which activities, if any, to crash, and determine the extent of crashing desirable, a manager needs certain information, such as the following:

- Regular time and crash time estimates for each activity
- Regular cost and crash cost estimates for each activity
- A list of activities that are on the critical path

Activities on the critical path are potential candidates for crashing, because shortening noncritical activities would not have an impact on total project duration. From an economic standpoint, activities should be crashed according to crashing costs: Crash those with the lowest crash costs first. Moreover, crashing should continue as long as the cost to crash is less than the benefits derived from crashing. Figure 17.11 illustrates the basic cost relationships.

Crashing analysis requires estimates of regular and crash times, the costs for each activity, the path lengths, and identification of critical activities. The general procedure for crashing is:

1. Crash the project one period at a time.
2. Crash the least expensive activity that is on the critical path.
3. If shortening results in multiple critical paths, find the sum of crashing the least expensive activity on each critical path. If two or more critical paths share common activities, compare the least expensive cost of crashing a common activity shared by critical paths with the sum for the separate critical paths.

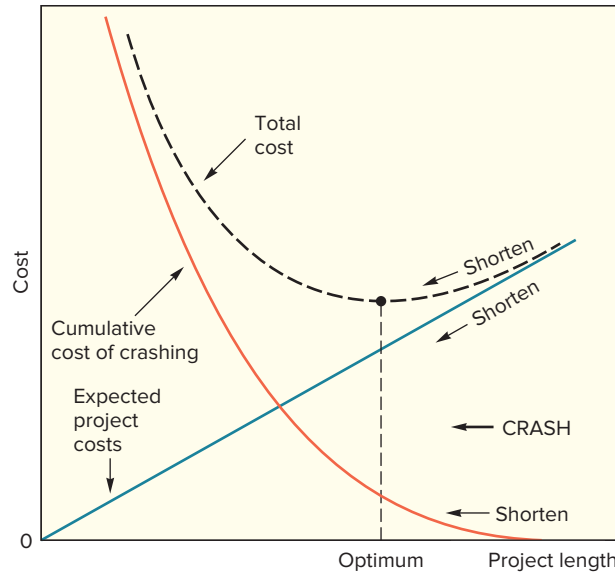

FIGURE 17.11
Crashing activities*

*Crashing activities reduce indirect project costs and increase direct costs; the optimum amount of crashing results in minimizing the sum of these two types of costs.

Optimal Project Crashing

Using the following information, develop the optimal time–cost solution. Project costs are \$1,000 per day.

EXAMPLE 7

excel
mhhe.com/stevenson14e

Activity	Normal Time	Crash Time	Cost per Day to Crash
a	6	6	—
b	10	8	\$500
c	5	4	300
d	4	1	700
e	9	7	600
f	2	1	800

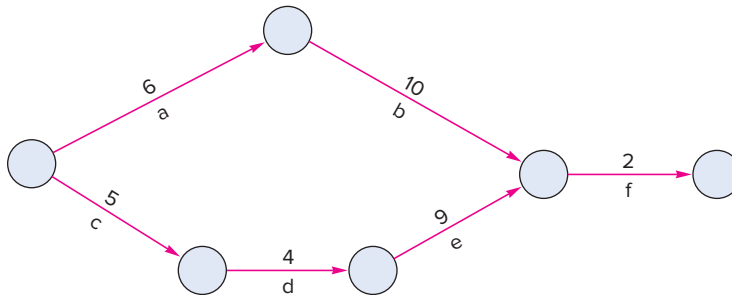

- a. Determine which activities are on the critical path, its length, and the length of the other path:

Path	Length
a–b–f	18
c–d–e–f	20 (critical path)

- b. Rank the critical path activities in order of lowest crashing cost, and determine the number of days each can be crashed. *Note:* Available days = Normal time – Crash time

Activity	Cost per Day to Crash	Available Days
c	\$300	1
e	600	2
d	700	3
f	800	1

SOLUTION

c. Begin shortening the project, one day at a time, and check after each reduction to see which path is critical. (After a certain point, another path may equal the length of the shortened critical path.) Thus:

- (1) Shorten activity *c* one day at a cost of \$300. The length of the critical path now becomes 19 days.
- (2) Activity *c* cannot be shortened any more. Shorten activity *e* one day at a cost of \$600. The length of path *c–d–e–f* now becomes 18 days, which is the same as the length of path *a–b–f*.
- (3) The paths are now both critical; further improvements will necessitate shortening both paths.

The remaining activities for crashing and their costs are:

Path	Activity	Crash cost per day
a–b–f	a	No reduction possible
	b	\$500
	f	800
c–d–e–f	c	No further reduction possible
	d	\$700
	e	600
	f	800

At first glance, it would seem that crashing *f* would not be advantageous, because it has the highest crashing cost. However, *f* is on *both* paths, so shortening *f* by one day would shorten *both* paths (and hence, the project) by one day for a cost of \$800. The option of shortening the least expensive activity on each path would cost \$500 for *b* and \$600 for *e*, or \$1,100. Thus, shorten *f* by one day. The project duration is now 17 days.

- (4) At this point, no additional improvement is feasible. The cost to crash *b* is \$500, and the cost to crash *e* is \$600, for a total of \$1,100. This would exceed the indirect project costs of \$1,000 per day.
- (5) The crashing sequence is summarized as follows:

Path	LENGTH AFTER CRASHING <i>n</i> DAYS			
	<i>n</i> = 0	1	2	3
a–b–f	18	18	18	17
c–d–e–f	20	19	18	17
Activity crashed		c	e	f
Cost		\$300	\$600	\$800

An important benefit of the sequential crashing procedure just described is that it provides the ability to quote different budget costs for different project times.

17.14 ADVANTAGES OF USING PERT AND POTENTIAL SOURCES OF ERROR

LO17.10 Discuss the advantages of using PERT and potential sources of error.

PERT and similar project scheduling techniques can provide important services for the project manager. Among the most useful features are the following:

- Use of these techniques forces the manager to organize and quantify available information and to recognize where additional information is needed.
- The techniques provide a graphic display of the project and its major activities.
- They identify (*a*) activities that should be closely watched because of the potential for delaying the project, and (*b*) other activities that have slack time and thus can be delayed without affecting project completion time. This raises the possibility of reallocating resources to shorten the project.

No analytical technique is without potential errors. Among the more important sources of errors are the following:

- When developing the project network, managers may unwittingly omit one or more important activities.
- Precedence relationships may not all be correct as shown.
- Time estimates may include a fudge factor; managers may feel uncomfortable about making time estimates because they appear to commit themselves to completion within a certain time period.
- There may be a tendency to focus solely on activities that are on the critical path. As the project progresses, other paths may become critical. Furthermore, major risk events may not be on the critical path.

17.15 CRITICAL CHAIN PROJECT MANAGEMENT

Critical chain project management (CCPM) is an approach to project management that includes an emphasis on the resources required to execute project tasks. It was developed by Eli Goldratt, who also developed the theory of constraints (see Chapter 16). Goldratt identifies certain aspects of projects that he believes managers need to be aware of to better manage projects:

- Time estimates are often pessimistic and with attention can be made more realistic (i.e., shortened).
- When activities are finished ahead of schedule, that fact may go unreported, so managers may be unaware of resources that could potentially be used to shorten the critical path.

The critical chain of a project is analogous to the critical path of a network. However, the critical chain approach takes into account not only sequential task relationships, but also resource constraints that can result in tasks being delayed when they must wait for a resource that is being used on another task.

A key feature of the critical chain approach is the use of various buffers. *Feeding (time) buffers* are positioned at points in the network where noncritical sections of the network feed into the critical chain path to reduce the risk of delaying critical chain activities. Their purpose is to insulate the critical chain from variation in noncritical chains' activities. Not every intersection will require a time buffer; only those sections that have a relatively small degree of slack time will provide benefit from a time buffer. A *project (time) buffer* at the end of the project is used to reduce the risk that time variations on the critical chain will interfere with timely project completion. *Capacity (resource) buffers* are used when multiple projects are ongoing to help manage the impact of variation of resource requirements among projects.

Regular updates of activity status relative to planned completion times can enable the project manager to see where actual or potential problems may arise, as well as where buffers can be reduced or eliminated, to reconfigure buffers.

17.16 OTHER TOPICS IN PROJECT MANAGEMENT

This section touches briefly on several other project management topics, including Six-Sigma projects, virtual project teams, and managing multiple projects.

One increasingly popular use of project management is for *Six-Sigma projects*. Although Six-Sigma projects tend to have a narrow focus, they still involve all of the typical elements and requirements of general project management. Six-Sigma projects are discussed in more detail in Chapter 9.

As companies globalize operations, they are increasingly using **virtual project teams**. All the basic elements of a project are present, but some or all of the team members are

Virtual project teams Some or all of the team members are geographically separated.

geographically separated. Recent advances in communication technology have made this feasible. A key benefit is the ability to tap into human talents and perspectives that would otherwise be difficult or impossible to use. A key disadvantage can be the inability to realize synergies that may arise from closer contact among team members. Also, there are risks if there are language or cultural differences among team members, so communications must be managed more carefully.

The existence of *multiple projects* can create added layers of pressure and complexity to project management. Resources often need to be shared across projects, and problems on one project may create issues for other projects, and can require reassessing priorities. When multiple projects are ongoing within an organization, resources needed for one project may be in use on another project, which could delay the project waiting for the resources to become available. Hence, it is important for managers to cross-check project schedules to avoid such conflicts. Project management software can help avoid conflicts when there are shared resources. In a related issue, *project slippage* can occur as a project nears completion if resources are transferred to new projects too quickly.

17.17 PROJECT MANAGEMENT SOFTWARE

There are many advantages to using a project management software package, especially for managing complex projects or multiple projects. Among them are the following:

- It imposes a methodology and a common project management terminology.
- It provides a logical planning structure.
- It can enhance communication among team members.
- It can flag the occurrence of constraint violations.
- It automatically formats reports.
- It can generate multiple levels of summary reports and detailed reports.
- It enables what-if scenarios.
- It can generate various chart types, including basic Gantt charts.

Depending on the nature and scope of a project, software choices range from a simple system like Google Drive to more robust systems that contain all project-related information and materials. Software platforms typically give users the ability to upload documents to specific tasks or projects. Some systems use message boards that enable team members to discuss issues or provide status updates. Moreover, they often record the history of each task and project, providing audit trails that enable project managers to view task progress and investigate challenges that team members may be experiencing.

Because of the variety of software systems available and their features, and the continuing change in what is available, rather than describe any particular system and its capabilities, if you would like to see what is available right now, it is suggested you do a search on the term *project management software*.

One thing to keep in mind is that project management is more than choosing the right software. There is much that a project manager must do. Recall the key decisions discussed early in the chapter.

17.18 OPERATIONS STRATEGY

Projects can present both strategic opportunities and strategic risks, so it is critical for management to devote adequate attention and resources to projects.

Projects are often used in situations that have some degree of uncertainty, which can result in delays, budget overruns, and failure to meet technical requirements. To minimize the

impact of these possibilities, management must ensure that careful planning, wise selection of project managers and team members, and monitoring of the project occur.

Computer software and tools such as PERT can greatly assist project management. However, care must be taken to avoid focusing exclusively on the critical path. The obvious reason is that as the project progresses, other paths may become critical. But another, less obvious reason is that key risk events may not be on the critical path. Even so, if they occur, they can have a major impact on the project.

It is not uncommon for projects to fail, either completely or partially. When that happens, it can be beneficial to examine the probable reasons for the failure, and decide what possible decisions or actions, if any, might have contributed to the failure. These become “lessons learned” that may be applicable to future projects to decrease the likelihood of failure.

17.19 RISK MANAGEMENT

Risks are inherent in projects. They relate to the occurrence of events that can have undesirable consequences, such as delays, increased costs, and an inability to meet technical specifications. In some instances, there is the risk that events will occur that will cause a project to be terminated. Although careful planning can reduce risks, no amount of planning can eliminate chance events due to unforeseen, or uncontrollable, circumstances.

The probability of occurrence of risk events is highest near the beginning of a project and lowest near the end. However, the cost associated with risk events tends to be lowest near the beginning of a project and highest near the end. (See Figure 17.12.)

Good risk management entails identifying as many potential risks as possible, analyzing and assessing those risks, working to minimize the probability of their occurrence, and establishing contingency plans (and funds) for dealing with any that do occur. Much of this takes place before the start of a project, although it is not unusual for this process to be repeated during the project as experience grows and new information becomes available.

The first step is to identify the risks. Typically, there are numerous sources of risks, although the more experience an organization has with a particular type of work, the fewer and more identifiable the risks. Everyone associated with the project should be responsible for identifying risks. Brainstorming sessions and questionnaires can be useful in this regard.

Once risks have been identified, each risk must be evaluated to determine its probability of occurrence and the potential consequences if it does occur. Both quantitative and qualitative approaches have merit. Managers and workers can contribute to this effort, and experts might be called on. Experience with previous projects can be useful. Many

LO17.11 Discuss the key steps in risk management.

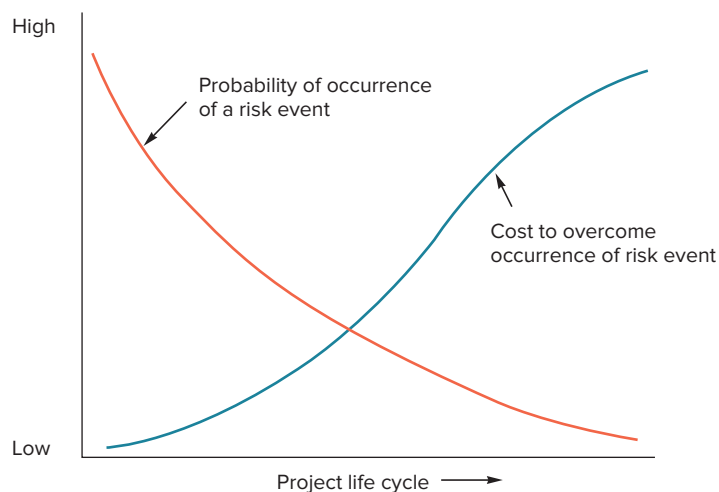

FIGURE 17.12
Risk event probability and cost

Source: Adapted from Clifford Gray and Erik W. Larson, *Project Management: The Managerial Process*, 4th ed., p. 198. Copyright © 2008 McGraw-Hill Education, Inc. Used with permission.

FIGURE 17.13

A risk matrix

Event	Probability	Cost
1	.85	\$18
2	.30	20
3	.55	68
4	.85	77
5	.10	30
6	.30	87

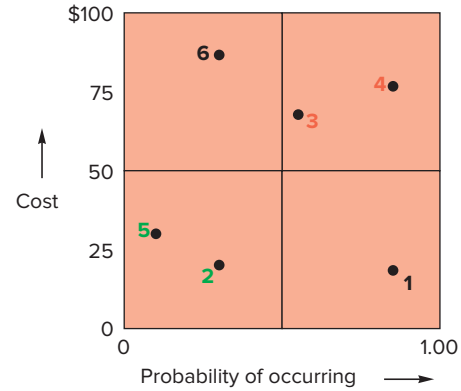

tools might be applied, including scenario analysis, simulation, and PERT (described earlier in the chapter).

Risk reduction can take a number of forms. Much depends on the nature and scope of a project. “Redundant” (backup) systems can sometimes be used to reduce the risk of failure. For example, an emergency generator could supply power in the event of an electrical failure. Another approach is frequent monitoring of critical project dimensions with the goal of catching and eliminating problems in their early stages, before they cause extensive damage. Risks can sometimes be transferred, say, by outsourcing a particular component of a project, or by having an insurance policy. Risk-sharing is another possibility. This might involve partnering, which can spread risks among partners. This approach may also reduce risk by enlarging the sphere of sources of ideas for reducing the risk.

A project leader may have to contend with multiple risks that have different costs and different probabilities of occurring. A simple matrix such as the one illustrated in Figure 17.13 can be used to put the risks into perspective.

Events in the upper right-hand quadrant (events 3 and 4) have the highest probability of occurring, and also high costs. They should be given the greatest attention. Conversely, events in the lower left-hand quadrant (events 2 and 5) have relatively low probabilities and low costs, so they should be given the least attention. Events in the other two quadrants (events 6 and 1) should get moderate attention due either to high cost (event 6) or high probability of occurrence (event 1).

SUMMARY

Projects are composed of a unique set of activities established to realize a given set of objectives in a limited time span. Projects go through a life cycle that involves definition, planning, execution, and delivery/termination. The nonroutine nature of project activities places a set of demands on the project manager that are different in many respects from those the manager of more routine operations activities experiences, both in planning and coordinating the work and in the human problems encountered. Ethical conduct and risk management are among the key issues project managers must deal with.

PERT and CPM are two commonly used techniques for developing and monitoring projects. Although each technique was developed independently and for expressly different purposes, time and practice have erased most of the original differences, so that now there is little distinction between the two. Either provides the manager with a rational approach to project planning and a graphical display of project activities. Both depict the sequential relationships that exist among activities and reveal to managers which activities must be completed on time to achieve timely project completion. Managers can use that information to direct their attention toward the most critical activities.

Two slightly different conventions can be used for constructing a network diagram. One designates the arrows as activities; the other designates the nodes as activities.

The task of developing and updating project networks quickly becomes complex for projects of even moderate size, so computer software is important. Among the advantages of using project management

software are the provision for a logical planning structure, enhanced communication, and automatically formatted charts and reports.

In some instances, it may be possible to shorten, or crash, the length of a project by shortening one or more of the project activities. Typically, such gains are achieved by the use of additional resources, although in some cases it may be possible to transfer resources among project activities. Generally, projects are shortened to the point where the cost of additional reduction would exceed the benefit of additional reduction, or they are shortened to a specified time.

1. Projects are unique, limited duration sets of tasks designed to accomplish a set of objectives.
2. The key project metrics are cost, time, and performance.
3. Table 17.1 and Figure 17.1 provide valuable insights into the nature of projects and project management.
4. The project manager and the project team can be major factors in achieving project goals.
5. Work breakdown structures, Gantt charts, and precedence diagrams are useful tools for managing projects.

KEY POINTS

activities, 743

activity-on-arrow (AOA), 743

activity-on-node (AON), 743

beta distribution, 753

CPM, 742

crash, 760

critical activities, 744

critical path, 744

deterministic, 745

events, 743

independence, 756

most likely time, 753

network (precedence) diagram,
743

optimistic time, 753

path, 743

PERT, 742

pessimistic time, 753

probabilistic, 745

project champion, 740

projects, 734

slack, 744

virtual project teams, 763

work breakdown structure
(WBS), 741

KEY TERMS

SOLVED PROBLEMS

The following table contains information related to the major activities of a research project. Use the information to do the following:

- a. Draw a precedence diagram using AOA.
- b. Find the critical path.
- c. Determine the expected length of the project.

Activity	Immediate Predecessor	Expected Time (days)
a	—	5
c	a	8
d	c	2
b	a	7
e	—	3
f	e	6
i	b, d	10
m	f, i	8
g	—	1
h	g	2
k	h	17
end	k, m	

- a. In constructing networks, these observations can be useful.

- (1) Activities with no predecessors are at the beginning (left side) of the network.
- (2) Activities with multiple predecessors are located at path intersections.

Problem 1

Solution

Complete the diagram in sections. Go down the activity list in order to avoid overlooking any activities.

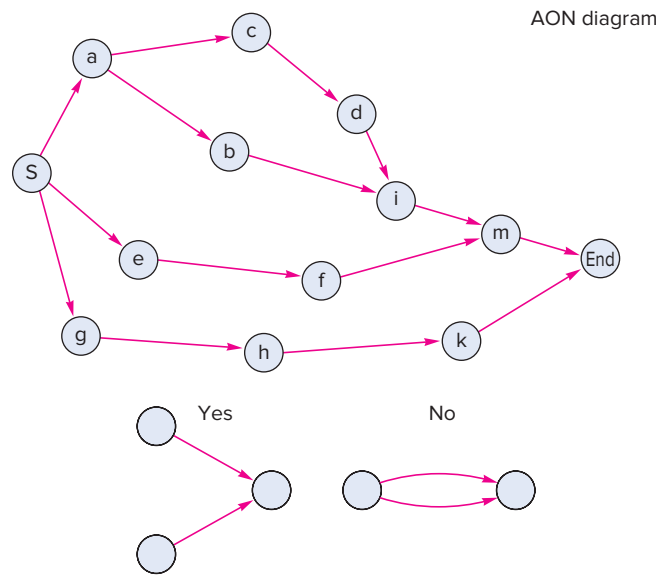
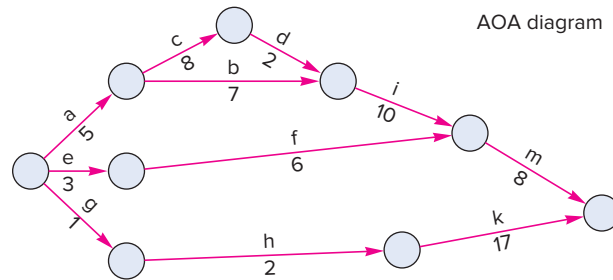

Here are some additional hints for constructing a precedence diagram.

- (1) Use pencil.
- (2) Start and end with a single node.
- (3) Avoid having paths cross each other.
- (4) Have activities go from left to right.
- (5) Use only one arrow between any pair of nodes.

b. and c.

Path	Length (days)
a-c-d-i-m*	$5 + 8 + 2 + 10 + 8 = 33^*$
a-b-i-m	$5 + 7 + 10 + 8 = 30$
e-f-m	$3 + 6 + 8 = 17$
g-h-k	$1 + 2 + 17 = 20$

*Critical path
 *Expected project duration

Problem 2 Using the computing algorithm, determine the slack times for the following AOA diagram. Identify the activities on the critical path.

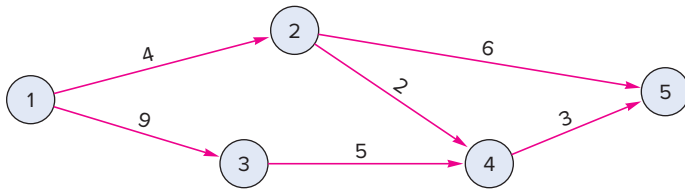

The task of determining ES, EF, LS, and LF times can be greatly simplified by setting up two brackets for each activity, as illustrated:

Solution

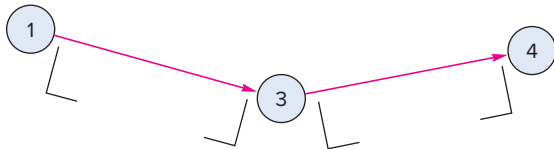

The bracket at the left of each activity will eventually be filled in with the earliest and latest *starting* times, and the bracket at the right end of each activity will be filled in with the earliest and latest *finishing* times:



This is accomplished in a two-step process. First, determine the earliest starting times and earliest finishing times, working from left to right, as shown in the following diagram.

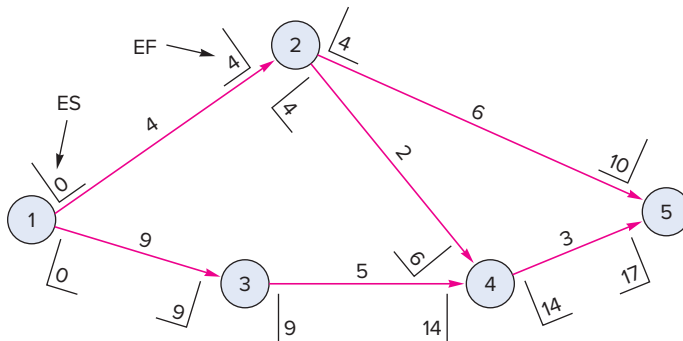

Thus, activity 1-2 can start at 0. With a time of 4, it can finish at $0 + 4 = 4$. This establishes the earliest start for all activities that begin at node 2. Hence, 2-5 and 2-4 can start no earlier than time 4. Activity 2-5 has an early finish of $4 + 6 = 10$, and activity 2-4 has an early finish of $4 + 2 = 6$. At this point, it is impossible to say what the earliest start is for 4-5; that will depend on which activity, 3-4 or 2-4, has the latest EF. Consequently, it is necessary to compute ES and EF along the lower path. Assuming an ES of 0 for activity 1-3, its EF will be 9, so activity 3-4 will have an ES of 9 and an EF of $9 + 5 = 14$.

Considering that the two activities entering node 4 have EF times of 6 and 14, the earliest that activity 4-5 can start is the *larger* of these, which is 14. Hence, activity 4-5 has an ES of 14 and an EF of $14 + 3 = 17$.

Now compare the EFs of the activities entering the final node. The larger of these, 17, is the expected project duration.

The LF and LS times for each activity can now be determined by working backward through the network (from right to left). The LF for the two activities entering node 5 is 17—the project duration. In other words, to finish the project in 17 weeks, these last two activities must both finish by that time.

In the case of activity 4-5, the LS necessary for an LF of 17 is $17 - 3 = 14$. This means that both activities 2-4 and 3-4 must finish no later than 14. Hence, their LF times are 14. Activity 3-4 has an LS time of $14 - 5 = 9$, making the LF of activity 1-3 equal to 9, and its LS equal to $9 - 9 = 0$.

Activity 2-4, with an LF time of 14, has an LS time of $14 - 2 = 12$. Activity 2-5 has an LF of 17 and therefore an LS of $17 - 6 = 11$. Thus, the latest activity 2-5 can start is 11, and the latest 2-4 can start is 12 in order to finish by week 17. Because activity 1-2 precedes *both* of these activities, it can finish no later than the *smaller* of these, which is 11. Hence, activity 1-2 has an LF of 11 and an LS of $11 - 4 = 7$.

The ES, EF, LF, and LS times are shown on the following network.

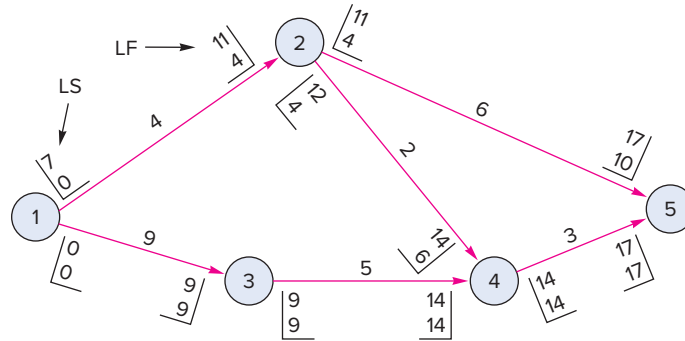

The slack time for any activity is the difference between *either* LF and EF *or* LS and ES. Thus,

Activity	LS	ES	Slack	or	LF	EF	Slack
1-2	7	0	7		11	4	7
2-5	11	4	7		17	10	7
2-4	12	4	8		14	6	8
1-3	0	0	0		9	9	0
3-4	9	9	0		14	14	0
4-5	14	14	0		17	17	0

The activities with zero slack times indicate the critical path. In this case, the critical path is 1-3-4-5. When working problems of this nature, keep in mind the following:

- The ES time for leaving activities of nodes with multiple entering activities is the largest EF of the entering activities.
- The LF for an entering activity for nodes with multiple leaving activities is the smallest LS of the leaving activities.

Problem 3 A path in a network has three activities. Their standard deviations are 1.50, 0.80, and 1.30. Find the path standard deviation.

Solution Standard deviations cannot be added, but variances can be added. Square each standard deviation to obtain its variance, and then add the resulting variances to obtain the path variance:

Standard Deviation	Variance
1.50	2.25
0.80	0.64
1.30	<u>1.69</u>
	4.58 (path variance)

The square root of the path variance is the path standard deviation:

$$\sqrt{4.58} = 2.14 \text{ (path standard deviation)}$$

Problem 4 Expected times in weeks, as well as variances, for the major activities of an R&D project are depicted in the following table. Determine the probability that project completion time will be:

- 50 weeks or less
- More than 50 weeks

Path	Activity	Mean	Variance
Top	A	16	.69
	B	11	.69
	C	24	.11
	D	5	0
Middle	E	18	.25
	F	26	.11
Bottom	D	5	0
	G	10	.25
	H	14	.36
	I	12	.11

Compute the mean and standard deviation for each path:

Path	Expected Time (weeks)	Standard Deviation (weeks)
Top	$16 + 11 + 24 = 51$	$\sqrt{.69 + .69 + .11} = 1.22$
Middle	$5 + 18 + 26 = 49$	$\sqrt{.00 + .25 + .11} = .60$
Bottom	$5 + 10 + 14 + 12 = 41$	$\sqrt{.00 + .25 + .36 + .11} = .85$

Solution

- a. Compute the z for each path for the length specified. For any path that has a z of +3.00 or more, treat its probability of completion before the specified time as 1.00. Use

$$z = \frac{50 - t_{\text{path}}}{\sigma_{\text{path}}}$$

The probability that each path will be completed in 50 weeks or less is shown in the corresponding diagram. (Probabilities are from Appendix B, Table B.) The probability that the project will be completed in 50 weeks or less depends on all three paths being completed in that time. Because z for the bottom path is greater than +3.00, it is treated as having a probability of completion in 50 weeks of 100 percent. It is less certain that the other two paths will be completed in that time. The probability that *both* will not exceed 50 is the *product* of their individual probabilities of completion. Thus, $.2061(.9525)(1.00) = .1963$.

- b. The probability that the project *will* exceed 50 weeks is the complement of this number, which is $1.000 - .1963 = .8037$. (Note that it is *not* the product of the path probabilities.)

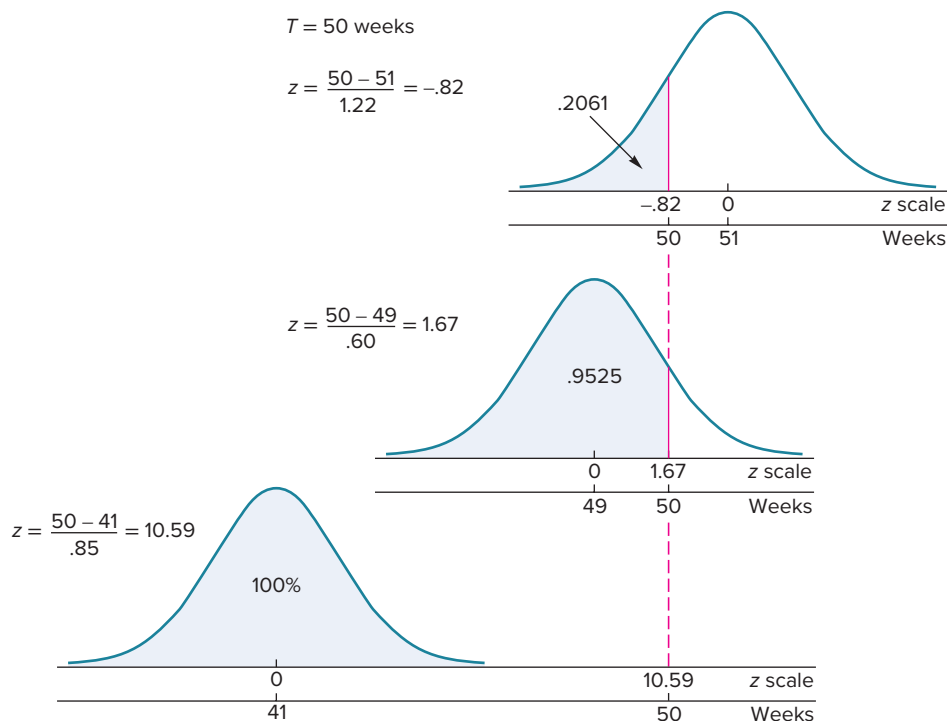

Problem 5 Costs for a project are \$12,000 per week for as long as the project lasts. The project manager has supplied the cost and time information shown. Use the information to:

- Determine an optimum crashing plan.
- Graph the total costs for the plan.

Activity	Crashing Potential (weeks)	Cost per Week to Crash
a	3	\$11,000
b	3	3,000 first week \$ 4,000 others
c	2	6,000
d	1	1,000
e	3	6,000
f	1	2,000

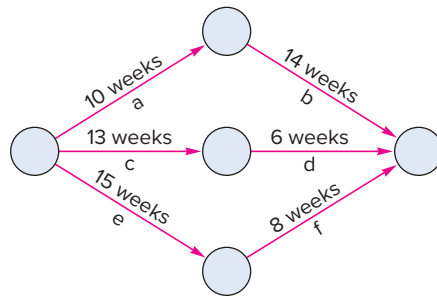

Solution a. (1) Compute path lengths and identify the critical path:

Path	Duration (weeks)
a-b	24 (critical path)
c-d	19
e-f	23

(2) Rank critical activities according to crash costs:

Activity	Cost per Week to Crash
b	\$ 3,000
a	11,000

Activity b should be shortened one week because it has the lower crashing cost. This would reduce indirect costs by \$12,000 at a cost of \$3,000, for a net savings of \$9,000. At this point, paths a-b and e-f would both have a length of 23 weeks, so both would be critical.

(3) Rank activities by crashing costs on the two critical paths:

Path	Activity	Cost per Week to Crash
a-b	b	\$ 4,000
	a	11,000
e-f	f	2,000
	e	6,000

Choose one activity (the least costly) on each path to crash: *b* on a-b, and *f* on e-f, for a total cost of \$4,000 + \$2,000 = \$6,000 and a net savings of \$12,000 - \$6,000 = \$6,000.

(4) Check to see which path(s) might be critical: a-b and e-f would be 22 weeks in length, and c-d would still be 19 weeks.

(5) Rank activities on the critical paths:

Path	Activity	Cost per Week to Crash
a-b	b	\$4,000
	a	11,000
e-f	e	6,000
	f	(no further crashing possible)

Crash b on path a-b and e on e-f for a cost of $\$4,000 + \$6,000 = \$10,000$, for a net savings of $\$12,000 - \$10,000 = \$2,000$.

(6) At this point, no further improvement is possible: paths a-b and e-f would be 21 weeks in length, and one activity from each path would have to be shortened. This would mean activity a at \$11,000 and e at \$6,000, for a total of \$17,000, which exceeds the \$12,000 potential savings in costs.

b. The following table summarizes the results, showing the length of the project after crashing *n* weeks:

Path	<i>n</i> = 0	1	2	3
a-b	24	23	22	21
c-d	19	19	19	19
e-f	23	23	22	21
Activity crashed		b	b, f	b, e
Crashing costs (\$000)		3	6	10

A summary of costs for the preceding schedule would look like this:

Project Length	Cumulative Weeks Shortened	Cumulative Crashing Costs (\$000)	Indirect Costs (\$000)	Total Costs (\$000)
24	0	0	24(12) = 288	288
23	1	3	23(12) = 276	279
22	2	3 + 6 = 9	22(12) = 264	273
21	3	9 + 10 = 19	21(12) = 252	271
20	4	19 + 17 = 36	20(12) = 240	276

The graph of total costs is as follows:

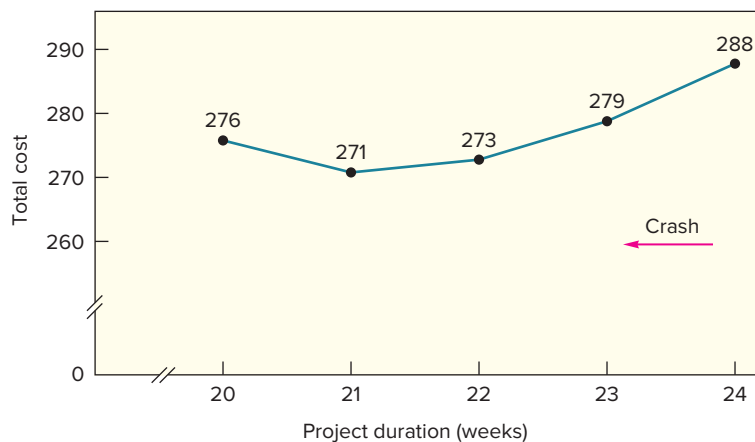

DISCUSSION AND REVIEW QUESTIONS

1. A project manager may need two skill sets—those of a manager and those of a leader. Explain.
2. Explain the term *project champion* and list some ways to keep a champion involved with the project.
3. List the steps in risk management.
4. Give some examples of ethical issues that may arise on projects. What can a project manager do to minimize such issues?
5. What are the key advantages of using project management software?
6. What is a work breakdown structure, and how is it useful for project planning?
7. Identify the term being described for each of the following:
 - a. A sequence of activities in a project.
 - b. The longest time sequence of activities in a project.
 - c. Used when two activities have the same starting and finishing points.
 - d. The difference in time length of any path and the critical path.
 - e. The statistical distribution used to describe variability of an activity time.
 - f. The statistical distribution used to describe path variability.
 - g. Shortening an activity by allocating additional resources.
8. List the main advantages of PERT. List the main limitations.
9. Why might a probabilistic estimate of a project's completion time based solely on the variance of the *critical path* be misleading? Under what circumstances would it be acceptable?
10. Define each of these terms, and indicate how each is determined.
 - a. Expected activity time.
 - b. Variance of an activity time.
 - c. Standard deviation of a path's time.
11. Why might a person wish to be involved with a critical path activity? What are some of the reasons one might have for not wanting this association?
12. What are some of the potential benefits of working on a special project in one's firm? What are some of the risks?
13. What are some aspects of the project manager's job that make it more demanding than the job of a manager working in a more routine organizational framework?
14. What is the main benefit of a project organization over more traditional forms of operations management for project work?

TAKING STOCK

1. What trade-offs are associated with time and cost estimates for a proposed project?
2. Who needs to be involved in assessing the cost of a project?
3. Name and explain briefly two ways that technology has had an impact on project management.

CRITICAL THINKING EXERCISES

1. Project management techniques have been used successfully for a wide variety of efforts, including NASA space missions, huge construction projects, the implementation of major systems such as ERP, the production of movies, development of new products and services, theatrical productions, and much more. Why not use them for managing the operations function of any business?
2. Give three examples of unethical conduct involving projects, as well as the ethical principle each one violates.

PROBLEMS

1. For each of the following network diagrams, determine both the critical path and the expected project duration. The numbers on the arrows represent expected activity times.
 - a. AOA diagram

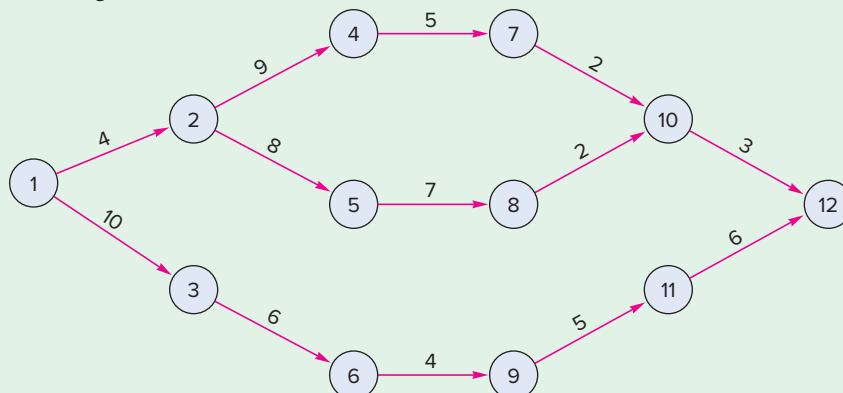

b. AON diagram

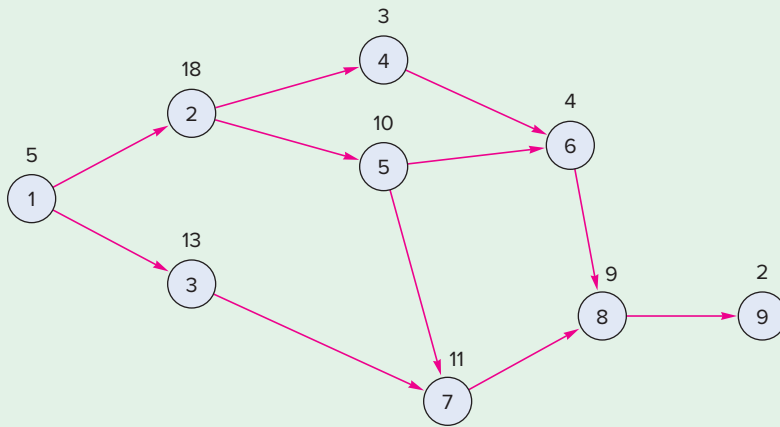

c. AOA diagram

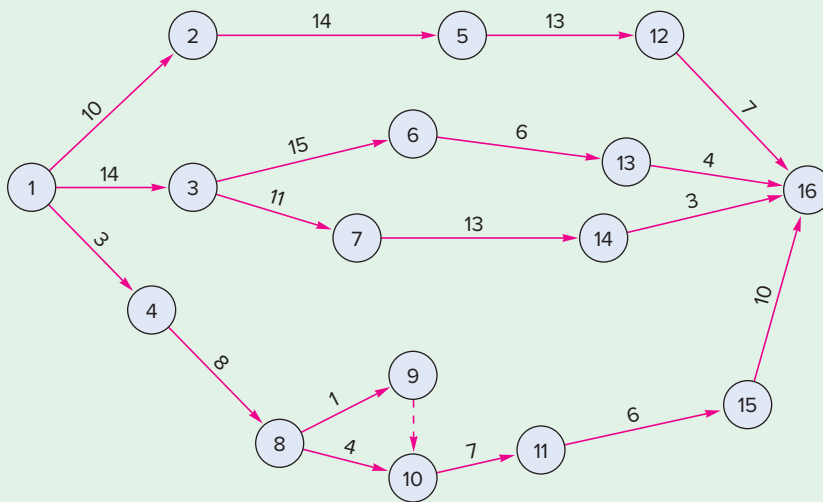

d. AON diagram

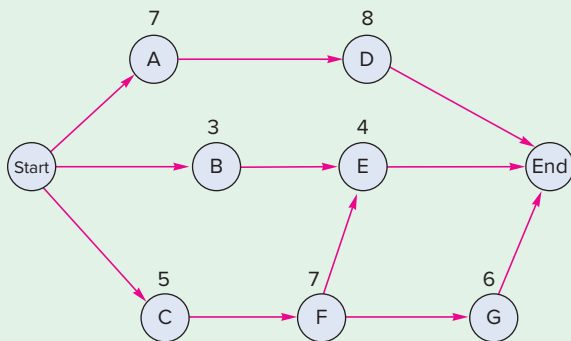

2. Chris received a new laptop for her birthday. She also received a check, with which she intends to purchase a new printer. Chris's college instructor assigned a paper due next week, so Chris decided to prepare the paper on her new computer. She made a list of the activities she needs to do, and their estimated times.

- a. Arrange Chris's activities into two logical sequences.
- b. (1) Construct an AOA network diagram.
(2) Construct an AON diagram.
- c. Determine the critical path and the expected duration time.

d. What are some possible reasons for the project to take longer than the expected duration?

Estimated Time (hrs.)	Activity (abbreviation)
0.8	Install computer software (Inst)
0.4	Outline the paper (Out)
0.2	Submit paper to the instructor (Sub)
0.6	Choose a topic (Ch)
0.5	Use grammar-checking routine and make corrections (Ck)
3.0	Write the paper using the new laptop (Write)
2.0	Shop for a new printer (Sh)
1.0	Select and purchase the printer and print the paper (Sel)
2.0	Do library research on the chosen topic (Lib)

3. Prepare a Gantt chart for each of the following in the style of the chart shown in section 17.5.
 - a. The bank location problem (see Figure 17.4). *Hint:* Use the early start (ES) times given in Table 17.3.
 - b. Solved Problem 2.
4. a. Develop a list of activities and their immediate predecessors similar to the lists in this problem for this diagram:

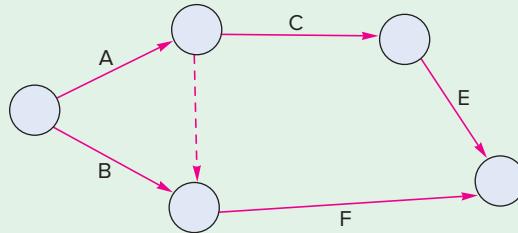

- b. Construct an activity-on-arrow precedence diagram for each of the following cases. Note that each case requires the use of a dummy activity.
- c. Construct an AON diagram for each case.

(1) Activity	Immediate Predecessor	(2) Activity	Immediate Predecessor
A	—	J	—
B	—	K	—
C	—	L	J
D	A	M	L
E	B	N	J
F	B	P	N
G	C	Q	—
H	F	R	K
I	F, G	S	Q
K	D, E	V	R, S, T
End	H, I, K	T	Q
		W	T
		End	M, P, V, W

5. For each of the problems listed, determine the following quantities for each activity: the earliest start time, latest start time, earliest finish time, latest finish time, and slack time. List the critical activities, and determine the expected duration of the project.
 - a. Problem 1a.
 - b. Problem 1b.

6. Reconsider the network diagram of Problem 1a. Suppose that, after 12 weeks, activities 1-2, 1-3, and 2-4 have been finished; activity 2-5 is 75 percent finished; and activity 3-6 is half-finished. How many weeks after the original start time should the project be finished?
7. Three recent college graduates have formed a partnership and have opened an advertising firm. Their first project consists of activities listed in the following table.
 - a. Draw the precedence diagram.
 - b. What is the probability that the project can be completed in 24 days or less? In 21 days or less?
 - c. Suppose it is now the end of the seventh day and that activities A and B have been completed, while activity D is 50 percent completed. Time estimates for the completion of activity D are 5, 6, and 7. Activities C and H are ready to begin. Determine the probability of finishing the project by day 24 and the probability of finishing by day 21.

TIME IN DAYS

Activity	Immediate Predecessor	Optimistic	Most Likely	Pessimistic
A	—	5	6	7
B	—	8	8	11
C	A	6	8	11
D	—	9	12	15
E	C	5	6	9
F	D	5	6	7
G	F	2	3	7
H	B	4	4	5
I	H	5	7	8
End	E, G, I			

- d. The partners have decided that shortening the project by two days would be beneficial, as long as it doesn't cost more than about \$20,000. They have estimated the daily crashing costs for each activity in thousands, as shown in the following table. Which activities should be crashed, and what further analysis would they probably want to do?

Activity	First Crash	Second Crash
C	\$8	\$10
D	10	11
E	9	10
F	7	9
G	8	9
H	7	8
I	6	8

8. The new director of special events at a large university has decided to completely revamp graduation ceremonies. Toward that end, a PERT chart of the major activities has been developed. The chart has five paths with expected completion times and variances, as shown in the table. Graduation day is 16 weeks from now. Assuming the project begins now, what is the probability that the project will be completed before
 - a. Graduation time?
 - b. The end of week 15?
 - c. The end of week 13?

Path	Expected Duration (weeks)	Variance
A	10	1.21
B	8	2.00
C	12	1.00
D	15	2.89
E	14	1.44

9. Construct a network diagram for the information in the following table. Use either AOA or AON (see Example 5 for either type). What is the probability that the project will take more than 10 weeks to complete if the activity means and standard deviations are as shown below? Times are in weeks.

Path	Activity	Mean	Standard Deviation
A	C	5	1.3
	D	4	1.0
B	E	8	1.6

Determine the probability that this project will take 16.5 or more weeks to complete:

Path	Activity	Mean	Standard Deviation
A	1-3	10	3
	3-4	3	1
	1-2	9	3
B	2-4	3	1

10. The project described in the following table is scheduled to be completed in 11 weeks. Construct a network diagram using AOA or AON (see Example 5 for either type). Then, answer the following questions:
- If you were the manager of this project, would you be concerned? Explain.
 - If there is a penalty of \$5,000 a week for each week the project is late, what is the probability of incurring a penalty of at least \$5,000?

Path	Activity	Estimated Time (weeks)	Standard Deviation (wks.)
A	C	4	0.70
	D	6	0.90
B	E	3	0.62
	F	9	1.90

11. The following precedence diagram reflects three time estimates in weeks for each activity. Determine:
- The expected completion time for each path and its variance.
 - The probability that the project will require more than 49 weeks.
 - The probability that the project can be completed in 46 weeks or less.

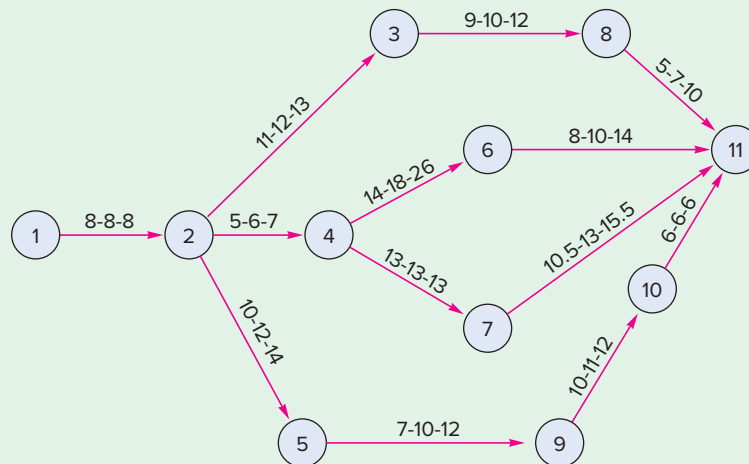

12. A project manager has compiled a list of major activities that will be required to install a computer information system in her firm. The list includes estimated completion times for activities and precedence relationships.

Activity	Immediate Predecessor	Estimated Times (weeks)	Activity	Immediate Predecessor	Estimated Times (weeks)
A	—	2-4-6	B	—	2-2-3
D	A	6-8-10	I	B	2-3-6
E	D	7-9-12	J	I	3-4-5
H	E	2-3-5	K	J	4-5-8
F	A	3-4-8	C	—	5-8-12
G	F	5-7-9	M	C	1-1-1
			N	M	6-7-11
			O	N	8-9-13
			End	H, G, K, O	

- a. Construct a network diagram. You can use either AOA or AON (see Example 5).
 - b. If the project is finished within 26 weeks of its start, the project manager will receive a bonus of \$1,000; and if the project is finished within 27 weeks of its start, the bonus will be \$500. Find the probability of each bonus.
13. The following is a list of activity times for a project, as well as crashing costs for its activities. Determine which activities should be crashed and the total cost of crashing if the goal is to shorten the project by three weeks as cheaply as possible. First construct a network diagram. You can use either an AOA or an AON (see Solved Problem 5).

Path	Activity	Duration (weeks)	First Crash	Second Crash
Top	A	5	\$8	\$10
	B	6	7	9
	C	3	14	15
Middle	D	3	9	11
	E	7	8	9
	C	3	14	15
Bottom	F	5	10	15
	G	5	11	13
	H	5	12	14

14. The project manager of a task force planning the construction of a domed stadium had hoped to be able to complete construction prior to the start of the next college football season. After reviewing construction time estimates, it now appears that a certain amount of crashing will be needed to ensure project completion before the season opener. Given the following time and cost estimates, determine a minimum-cost crashing schedule that will shave five weeks off the project length. *Note:* No activity can be crashed more than two weeks.

Activity	Immediate Predecessor	Normal Time (weeks)	CRASHING COSTS (\$000)	
			First Week	Second Week
A	—	12	\$15	\$20
B	A	14	10	10
C	—	10	5	5
D	C	17	20	21
E	C	18	16	18
F	C	12	12	15
G	D	15	24	24
H	E	8	—	—
I	F	7	30	—
J	I	12	25	25
K	B	9	10	10
M	G	3	—	—
N	H	11	40	—
P	H, J	8	20	20
End	K, M, N, P			

15. A construction project has indirect costs totaling \$40,000 per week. Major activities in the project and their expected times in weeks are shown in this precedence diagram.

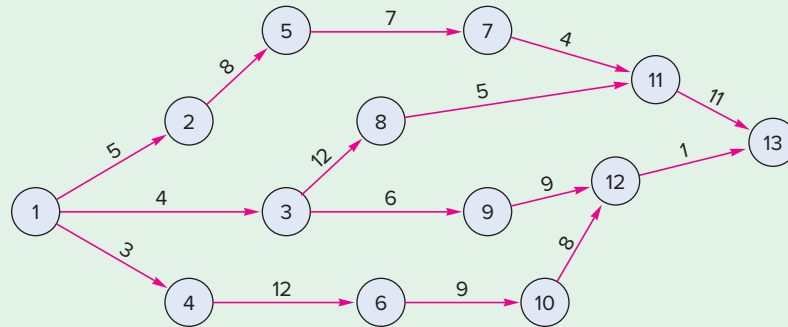

Crashing costs for each activity are:

Activity	CRASHING COSTS (\$000)		
	First Week	Second Week	Third Week
1-2	\$18	\$22	\$—
2-5	24	25	25
5-7	30	30	35
7-11	15	20	—
11-13	30	33	36
1-3	12	24	26
3-8	—	—	—
8-11	40	40	40
3-9	3	10	12
9-12	2	7	10
12-13	26	—	—
1-4	10	15	25
4-6	8	13	—
6-10	5	12	—
10-12	14	15	—

- Determine the optimum time–cost crashing plan.
 - Plot the total-cost curve that describes the least expensive crashing schedule that will reduce the project length by six weeks.
16. Chuck’s Custom Boats (CCB) customizes speedboats to each customer’s order. CCB has landed a contract with a mysterious New York lawyer (Mr. T). Relevant data are shown in the following table. The complication is that Mr. T wants delivery in 32 days or he will impose a penalty of \$375 for each day his boat is late. *Note:* No activity can be crashed more than two days.

Activity	Immediate Predecessor	Normal Time (days)	CRASHING COSTS	
			1st Day	2nd Day
K	—	9	\$410	\$415
L	K	7	125	—
N	K	5	45	45
M	L	4	300	350
J	N	6	50	—
Q	J, M	5	200	225
P	Q	8	—	—
Y	Q	7	85	90
Z	P	6	90	—
End	Y, Z			

Develop a crashing schedule.

17. Given the following table, construct a network diagram, either AOA or AON. Times are in days.
- Determine the expected duration of the project.
 - Compute the probability that the project will take at least 18 days.

Path	Activity	Time Estimates
Top	A	4-5-6
	B	7-8-10
	C	3-5-9
Bottom	D	7-8-11
	E	2-3-4
	F	1-4-6

18. Create a risk matrix in the style of Figure 17.13 for this project. Use a vertical scale of \$0 to \$80. Which event should the project manager be most concerned about?

Event	Probability	Cost (\$000)
1	.25	15
2	.35	25
3	.20	55
4	.80	10
5	.10	77
6	.40	55
7	.60	50

19. Create a risk matrix for this project:

Event	Cost (\$000)	Probability
Equipment breakdown	40	.20
Vendor is late with key segment	200	.60
Subcontractor has labor issues	140	.30
Weather problems	15	Unknown
Funding delays	50	.40 to .60
Testing delays	20	.40

Explain your reasoning for your placement of the events Weather problems and Funding delays.

CASE TIME, PLEASE

B. “Smitty” Smith is a project manager for a large consumer electronics corporation. Although she has been with the company only four years, she has demonstrated an uncanny ability to bring projects in on time, meet technical specifications, and be close to budget. Her latest assignment is a project that will involve merging two existing technologies. She and her team have almost finished developing the proposal that will be presented to a management committee for approval. All that remains to be done is to develop a time estimate for the project. The team has to construct a network diagram for the project. It has three paths. The expected durations and standard deviations for the paths are listed in the following table.

Path	Expected Duration (weeks)	Standard Deviation
A	10	4
B	14	2
C	13	2

What project durations (in weeks) should Smitty include in the proposal for these risks of not delivering the project on time: 5 percent, 10 percent, or 15 percent? What are the pros and cons of quoting project times aggressively? Conservatively?

**SELECTED
BIBLIOGRAPHY AND
FURTHER READINGS**

- Chatfield, Carl, and Timothy D. Johnson. *Microsoft Project (2013) Step by Step*. Redmond, WA: Microsoft Press, 2013.
- Goldratt, Eliyahu. *Critical Chain*. Great Barrington, MA: North River Press, 1997.
- HBR Guide to Project Management*. Watertown, MA: Harvard Business School Publishing Corporation, 2012.
- Heagney, Joseph. *Fundamentals of Project Management*, 4th ed. New York: American Management Association, 2012.
- Heldman, Kim. *Project Management Jump Start*, 3rd ed. New York: Wiley, 2011.
- Horine, Gregory M. *Project Management: Absolute Beginner's Guide*, 3rd ed. Indianapolis: Que Publishing, 2013.
- Leach, Lawrence P. *Critical Chain Project Management*. Artech House, 2014.
- Project Management Body of Knowledge*, 6th ed. [A Guide to the Project Management Body of Knowledge]: PMBOK(R) Guide by Project Management Institute. Newtown Square, PA: Project Management Institute, 2017.
- Richardson, Gary L. and Brad M. Jackson. *Project Management: Theory and Practice*, 3rd ed. Boca Raton, FL: CRC Press, 2018.
- Wysoki, Robert K. *Effective Project Management: Traditional, Agile, Extreme*, 6th ed. New York: Wiley, 2012.

18

CHAPTER

Management of Waiting Lines

LEARNING OBJECTIVES

After completing this chapter, you should be able to solve typical problems using the models presented in this chapter, and answer these questions:

- LO18.1** What imbalance does the existence of a waiting line reveal?
- LO18.2** What causes waiting lines to form, and why is it impossible to eliminate them completely?
- LO18.3** What metrics are used to help managers analyze waiting lines?
- LO18.4** What very important lesson does the constant service time model provide for managers?
- LO18.5** What are some psychological approaches to managing waiting lines, and why might a manager want to use them?

CHAPTER OUTLINE

- | | | |
|--|--|--|
| 18.1 Why Is There Waiting? 786 | Queue Discipline 792 | Cost Analysis 801 |
| 18.2 Managerial Implications of Waiting Lines 787 | 18.5 Measures of Waiting-Line Performance 792 | Maximum Line Length 803 |
| 18.3 Goal of Waiting-Line Management 788 | 18.6 Queuing Models: Infinite-Source 793 | Multiple Priorities 804 |
| 18.4 Characteristics of Waiting Lines 789 | Basic Relationships 794 | 18.7 Queuing Model: Finite-Source 807 |
| Population Source 789 | Single Server, Exponential Service Time, M/M/1 795 | 18.8 Constraint Management 813 |
| Number of Servers (Channels) 789 | Single Server, Constant Service Time, M/D/1 796 | 18.9 The Psychology of Waiting 813 |
| Arrival and Service Patterns 790 | Multiple Servers, M/M/S 797 | 18.10 Operations Strategy 814 |
| | | Case: Big Bank 822 |



Corbis/Splash News/Newscom

Climbers waiting in line to reach the top of Mt. Everest. Unfortunately, the long wait and lower oxygen levels at that height posed a serious health risk. Some of those in line collapsed, and several of those actually died.

The mission of Walt Disney theme parks is to “make people happy,” and the folks at Disney World in Orlando are masters at doing that. They realize that waiting in lines at attractions does not add to the enjoyment of their customers. They also realize that customers waiting in lines are not generating the revenue they would if they visited restaurants and souvenir shops. Hence, they have several reasons for wanting to reduce waiting times. A reservation system called FastPass for some attractions allows customers to reserve visit times instead of having to wait in line. This is a win-win solution: Customers are happier because they don’t have to wait in line, and the park’s potential for additional revenue is increased. Also, there is a free app that allows visitors to see how long the wait is for every ride or attraction, giving visitors a heads up on waiting times. You will learn more about Disney’s approaches to waiting lines later in the chapter.

Waiting lines occur when there is a temporary imbalance between supply (capacity) and demand. If demand is less than capacity, although there is not a waiting line of customers, there is idle capacity, which, in effect is a “waiting line.” Waiting lines add to the cost of operation and they reflect negatively on customer service, or a waste of resources if capacity (temporarily) exceeds demand, so it is important to balance the cost of having customers wait with the cost of providing service capacity. Customer waiting lines occur when there is too little capacity to handle demand, but having more capacity than what is needed to handle demand means there is idle (unproductive) capacity. From a managerial perspective, the key is to determine the balance that will provide an adequate level of service at a reasonable cost.

Waiting lines abound in all sorts of service systems. They are *non-valued-added* occurrences. In lean systems, waiting is one of the seven wastes. For customers, having to wait for service can range from being acceptable (usually short waits), to being annoying

LO18.1 What imbalance does the existence of a waiting line reveal?

Passengers wait to buy tickets at Termini train station in Rome. As one of the largest railway stations in Europe, Termini serves over 150 million passengers each year, connecting Rome to most of Italy and some European destinations.



ANDREAS SOLARO/AFP/Getty Images

(longer waits), to being a matter of life and death (e.g., in emergencies). For businesses, the costs of waiting come from lower productivity and competitive disadvantage. For society, the costs are wasted resources (e.g., fuel consumption of cars stuck in traffic) and reduced quality of life. Hence, it is important for system designers and managers of existing service systems to fully appreciate the impact of waiting lines.

Designers must weigh the cost of providing a given level of service capacity against the potential (implicit) cost of having customers wait for service. This planning and analysis of service capacity frequently lends itself to **queuing theory**, which is a mathematical approach to the analysis of waiting lines. Queuing theory is directly applicable to a wide range of service operations, including call centers, banks, post offices, restaurants, theme parks, telecommunications systems, and traffic management.

The foundation of modern queuing theory is based on studies about automatic dialing equipment made in the early part of the 20th century by Danish telephone engineer A. K. Erlang, who used queuing theory to determine how many phone lines (no cell phones in those days) and operators companies needed to provide adequate service. Prior to World War II, very few attempts were made to apply queuing theory to other business problems. Since that time, queuing theory has been applied to a wide range of problems.

The mathematics of queuing can be complex. For that reason, the emphasis here will not be on the mathematics but on the concepts that underlie the use of queuing in analyzing waiting-line problems. We shall rely on the use of formulas and tables for analysis.

Waiting lines are commonly found wherever customers arrive *randomly* for services. Some examples of waiting lines we encounter in our daily lives include the lines at supermarket checkouts, fast-food restaurants, airport ticket counters, theaters, post offices, and toll booths. In many situations, the “customers” are not people but orders waiting to be filled, trucks waiting to be unloaded, jobs waiting to be processed, or equipment awaiting repairs. Still other examples include ships waiting to dock, planes waiting to land, and cars waiting at a stop sign.

One reason queuing analysis is important is because customers regard waiting negatively. Customers may tend to associate this with poor service quality, especially if the wait is long. Similarly, in an organizational setting, having work or employees wait is the sort of waste that workers in lean systems strive to reduce.

The discussion of queuing begins with an examination of what is perhaps the most fundamental issue in waiting-line theory: Why is there waiting?

18.1 WHY IS THERE WAITING?

Many people are surprised to learn that waiting lines tend to form even though a system is basically underloaded. For example, a fast-food restaurant may have the capacity to handle an average of 200 orders per hour and yet experience waiting lines even though the average

Queuing theory Mathematical approach to the analysis of waiting lines.

LO18.2 What causes waiting lines to form, and why is it impossible to eliminate them completely?



According to a survey conducted with 1,000 adults standing in lines throughout New York City, most consumers would actually prefer to clean their bathroom (42 percent), sit in traffic (20 percent), or go to the dentist (18 percent) than stand in line. In some cases, efforts are being made to alleviate some of the waiting. One example is in supermarkets.

Waving “Goodbye” to Waiting in Line at Supermarkets

BY LISA SPENCER

Buying groceries or other items without waiting in line is the wave of the future. Walk in, scan your phone, shop, and leave. Trailblazer Amazon has shown what is possible with its first cashier-less stores in Chicago, San Francisco, and Seattle, and other retailers may soon follow. Amazon Go stores sell lunch items, over-the-counter medicines, groceries, and other goods typically found in convenience stores or small grocery outlets. As customers enter the store, they hold the Amazon Go app on their cell phones to a scanner that registers their presence. The store ceiling houses sensors and cameras that log the items shoppers choose, and purchases are charged to shoppers’ debit or credit card as they exit the store. Upon leaving, customers receive messages showing their shopping times, further reinforcing the quickness and convenience of the experience.

Sam’s Club and 7-Eleven are testing similar cashier-less technology from other tech startup companies. Some interesting technological twists may also be in store for shoppers. For instance, facial recognition tools could be used to entice customers

to buy items they picked up and put back by sending them coupons while they shop. Some observers raise questions about privacy concerns related to tracking customers’ shopping habits using facial recognition software, but others feel the added coupon benefits will make the technology even more appealing. For now, the technological development focuses on using the cameras to detect the objects being selected rather than the people who are choosing them.

From a retailer’s perspective, no need for cashiers means saving money, and no space for waiting lines makes more room for merchandise. In addition, real-time purchase tracking means it is easier to know when to replenish shelves that are running low. The reality is that most retailers will likely still provide a cash-payment option so as not to deter lower-income shoppers who don’t have credit cards or bank accounts, or those who simply prefer a more traditional approach to shopping. However, before long, using traditional checkout stands might well be the exception rather than the norm.

1. How will cashier-less technology affect the costs associated with waiting?
2. How does cashier-less technology affect the shopping experience?

Based on: Michael Liedtke and Joseph Pisani, “Checkout lines disappear as stores embrace technology.” App.com, February 19, 2019. <https://www.app.com/story/money/business/2019/02/19/checkout-lines-disappear-stores-embrace-technology/2822537002>

number of orders is only 150 per hour. The key word is *average*. In reality, customers arrive at random intervals rather than at evenly spaced intervals, and some orders take longer to fill than others. In other words, both arrivals and service times exhibit a high degree of variability. And because services cannot be performed ahead of time and stored until needed, the system at times becomes temporarily overloaded, giving rise to waiting lines. However, at other times, the system is idle because there are no customers. It follows that in systems where variability is minimal or nonexistent (e.g., because arrivals can be scheduled and service time is constant), waiting lines do not ordinarily form. JIT/lean systems strive to achieve this.

18.2 MANAGERIAL IMPLICATIONS OF WAITING LINES

Managers have a number of very good reasons to be concerned with waiting lines. Chief among those reasons are the following:

- The cost to provide waiting space
- A possible loss of business should customers leave the line before being served or refuse to wait at all
- A possible loss of goodwill
- A possible reduction in customer satisfaction
- The resulting congestion may disrupt other business operations and/or customers

18.3 GOAL OF WAITING-LINE MANAGEMENT

In a queuing system, customers enter the waiting line of a service facility, receive service when their turn comes, and then leave the system. The number of customers in the system (awaiting service or being served) will vary randomly over time. The goal of waiting-line management is essentially to minimize total costs. There are two basic categories of cost in a queuing situation: those associated with customers waiting for service, and those associated with capacity. Thus,

$$TC = \text{Customer waiting cost} + \text{Capacity cost}$$

Capacity costs are the costs of maintaining the ability to provide service. Examples include the number of bays at a car wash, the number of checkouts at a supermarket, the number of repair people to handle equipment breakdowns, and the number of lanes on a highway. When a service facility is idle, capacity is lost because it cannot be stored. The costs of customers waiting include the salaries paid to employees while they wait for service (mechanics waiting for tools, the drivers of trucks waiting to unload), the cost of the space for waiting (size of doctor's waiting room, length of driveway at a car wash, fuel consumed by planes waiting to land), and any loss of business due to customers refusing to wait and possibly going elsewhere in the future.

A practical difficulty frequently encountered is pinning down the cost of customer waiting time, especially because major portions of that cost are not a part of accounting data. One approach often used is to treat waiting times or line lengths as a policy variable: A manager simply specifies an acceptable level of waiting and directs that capacity be established to achieve that level.

The goal of waiting-line management is to balance the cost of providing a level of service capacity with the cost of customers waiting for service. Figure 18.1 illustrates this concept. Note that as capacity increases, its cost increases. For simplicity, the increase is shown as a linear relationship. Although a step function is often more appropriate, use of a straight line does not significantly distort the picture. As capacity increases, the number of customers waiting and the time they wait tend to decrease, thereby decreasing waiting costs. As is typical in trade-off relationships, total costs can be represented as a U-shaped curve. The goal of analysis is to identify a level of service capacity that will minimize total cost. (Unlike the situation in the inventory EOQ model, the minimum point on the total cost curve is *not* usually where the two cost lines intersect.)

In situations where those waiting in line are *external* customers (as opposed to employees), the existence of waiting lines can reflect negatively on an organization's *quality* image. Consequently, some organizations are focusing their attention on providing faster service—speeding up the rate at which service is delivered rather than merely increasing the number of servers. The effect of this is to shift the total cost curve downward if the cost of customer waiting decreases by more than the cost of the faster service.

FIGURE 18.1

The goal of waiting-line management is to minimize the sum of two costs: the costs associated with customers waiting and service capacity costs.

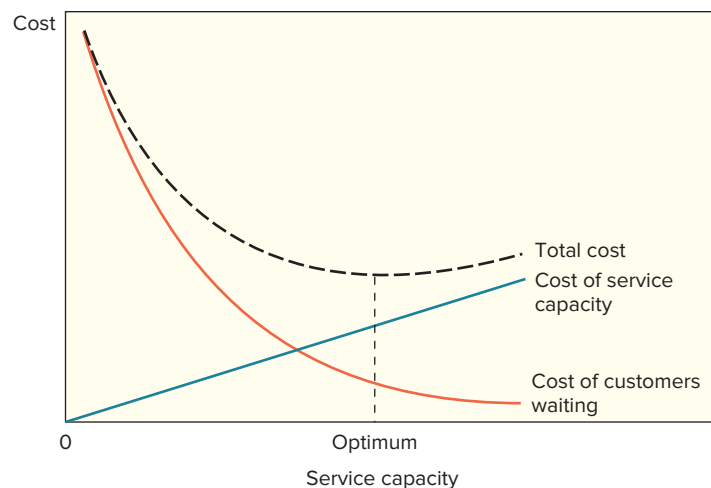

18.4 CHARACTERISTICS OF WAITING LINES

There are numerous queuing models from which an analyst can choose. Naturally, much of the success of the analysis will depend on choosing an appropriate model. Model choice is affected by the characteristics of the system under investigation. The main characteristics are:

- Population source
- Number of servers (channels)
- Arrival and service patterns
- Queue discipline (order of service)

Figure 18.2 depicts a simple queuing system.

Population Source

The approach to use in analyzing a queuing problem depends on whether the potential number of customers is limited. There are two possibilities: *infinite-source* and *finite-source* populations. In an **infinite-source situation**, the *potential* number of customers greatly exceeds system capacity. Infinite-source situations exist whenever service is *unrestricted*. Examples are supermarkets, drugstores, banks, restaurants, theaters, amusement centers, and toll bridges. Theoretically, large numbers of customers from the “calling population” can request service at any time. When the potential number of customers is limited, a **finite-source situation** exists. An example is the repair technician responsible for a certain number of machines in a company. The potential number of machines that might need repairs at any one time cannot exceed the number of machines assigned to the repairer. Similarly, an operator may be responsible for loading and unloading a bank of four machines, a nurse may be responsible for answering patient calls for a 10-bed ward, a secretary may be responsible for taking dictation from three executives, and a company shop may perform repairs as needed on the firm’s 20 trucks.

Infinite-source situation

Customer arrivals are unrestricted.

Finite-source situation

The number of potential customers is limited.

Number of Servers (Channels)

The capacity of queuing systems is a function of the capacity of each server and the number of servers being used. The terms *server* and **channel** are synonymous, and it is generally assumed that each channel can handle one customer at a time. Systems can be either *single-* or *multiple-channel*. (A group of servers working together as a team, such as a surgical team, is treated as a single-channel system.) Examples of single-channel systems are small grocery stores with one checkout counter, some theaters, single-bay car washes, and drive-in banks with one teller. Multiple-channel systems (those with more than one server) are commonly found in banks, at airline ticket counters, at auto service centers, and at gas stations.

Channel A server in a service system.

A related distinction is the number of steps or *phases* in a queuing system. For example, at theme parks, people go from one attraction to another. Each attraction constitutes a separate phase where queues can (and usually do) form.

Figure 18.3 illustrates some of the most common queuing systems. Because it would not be possible to cover all of these cases in sufficient detail in the limited amount of space available here, our discussion will focus on *single-phase* systems. Note that for most systems, a single waiting line that results in first-come, first-served, is favored by humans because it is

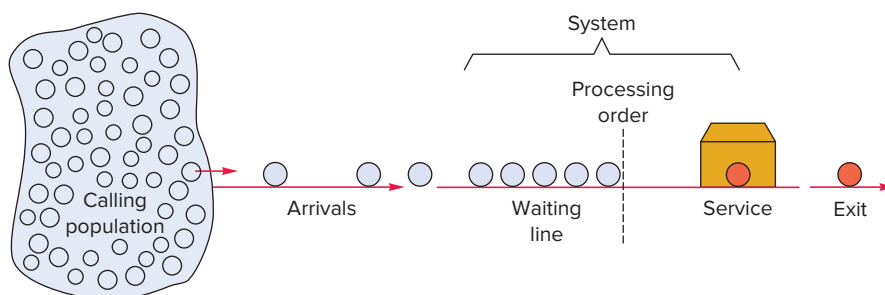
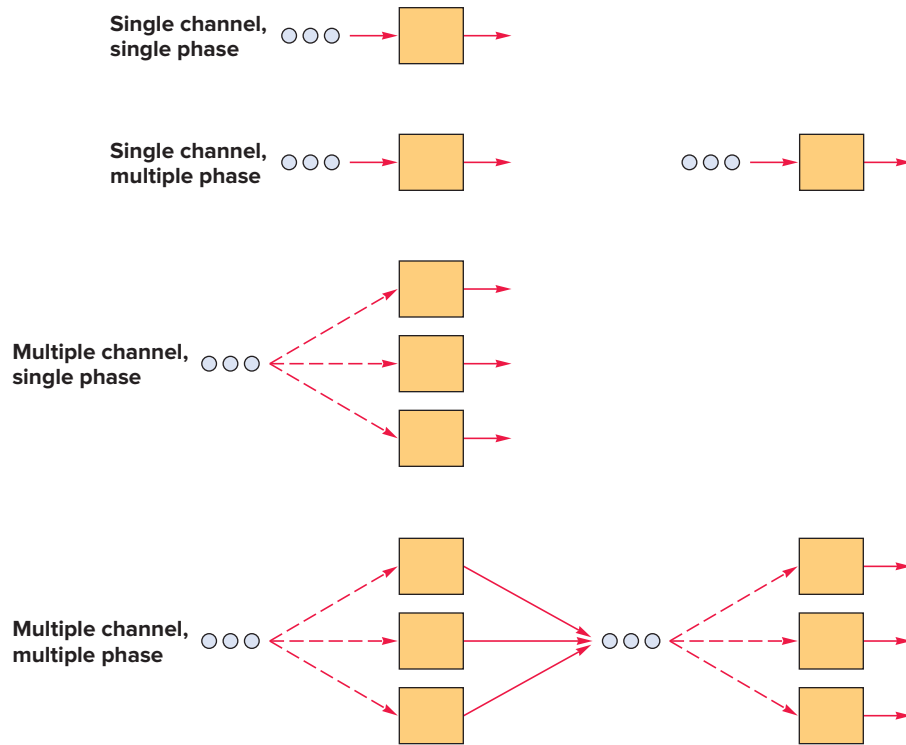

FIGURE 18.2

A simple queuing system

FIGURE 18.3
Four common variations of queuing systems



associated with “fairness.” Later in the chapter you will learn about priority systems, which are not first-come, first-served.

Arrival and Service Patterns

Remember, waiting lines are a direct result of arrival and service variability. They occur because random, highly variable arrival and service patterns cause systems to be temporarily overloaded. In many instances, the variabilities can be described by theoretical distributions. In fact, the most commonly used models assume that arrival and service rates can be described by a Poisson distribution or, equivalently, that the interarrival time and service time can be described by a negative exponential distribution. Figure 18.4 illustrates these distributions.

The Poisson distribution often provides a reasonably good description of customer arrivals per unit of time (e.g., per hour). Figure 18.5A illustrates how Poisson-distributed arrivals (e.g., accidents) might occur during a three-day period. In some hours, there are three or four arrivals; in other hours, one or two arrivals; and in some hours, no arrivals.

FIGURE 18.4 Poisson and negative exponential distributions

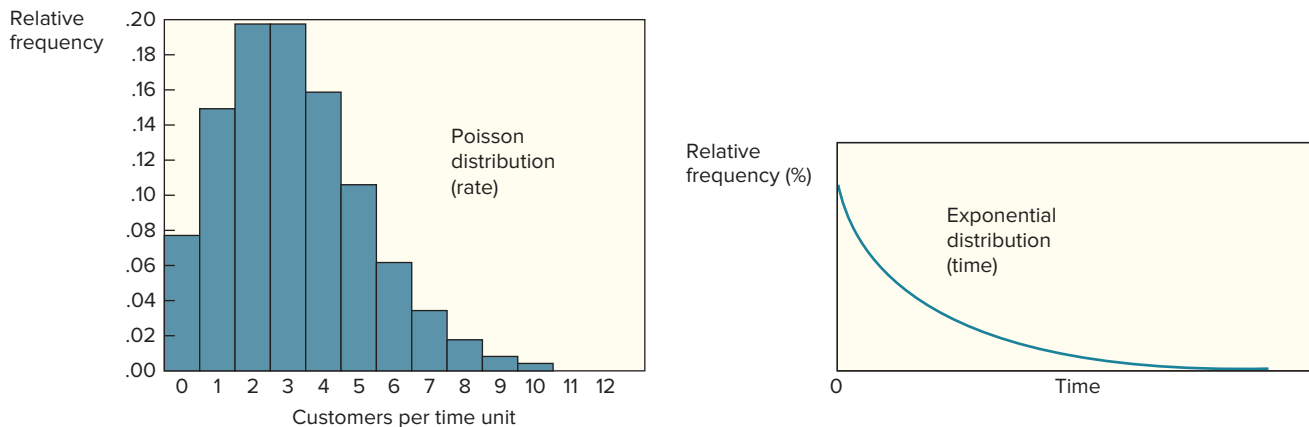

The negative exponential distribution often provides a reasonably good description of customer service times (e.g., first-aid care for accident victims). Figure 18.5B illustrates how exponential service times might appear for the customers whose arrivals are illustrated in Figure 18.5A. Note that most service times are very short—some are close to zero—but a few require a relatively long service time. That is typical of a negative exponential distribution.

Waiting lines are most likely to occur when arrivals are bunched or when service times are particularly lengthy, and they are very likely to occur when both factors are present. For instance, note the long service time of customer 7 on day 1 in Figure 18.5B. In Figure 18.5A, the seventh customer arrived just after 10 o'clock, and the next two customers arrived shortly after that, making it very likely a waiting line formed. A similar situation occurred on day 3 with the last three customers: The relatively long service time for customer 13 (Figure 18.5B) and the short time before the next two arrivals (Figure 18.5A, day 3) would create (or increase the length of) a waiting line.

It is interesting to note that the Poisson and negative exponential distributions are alternate ways of presenting the same basic information. That is, if service time is exponential, then the

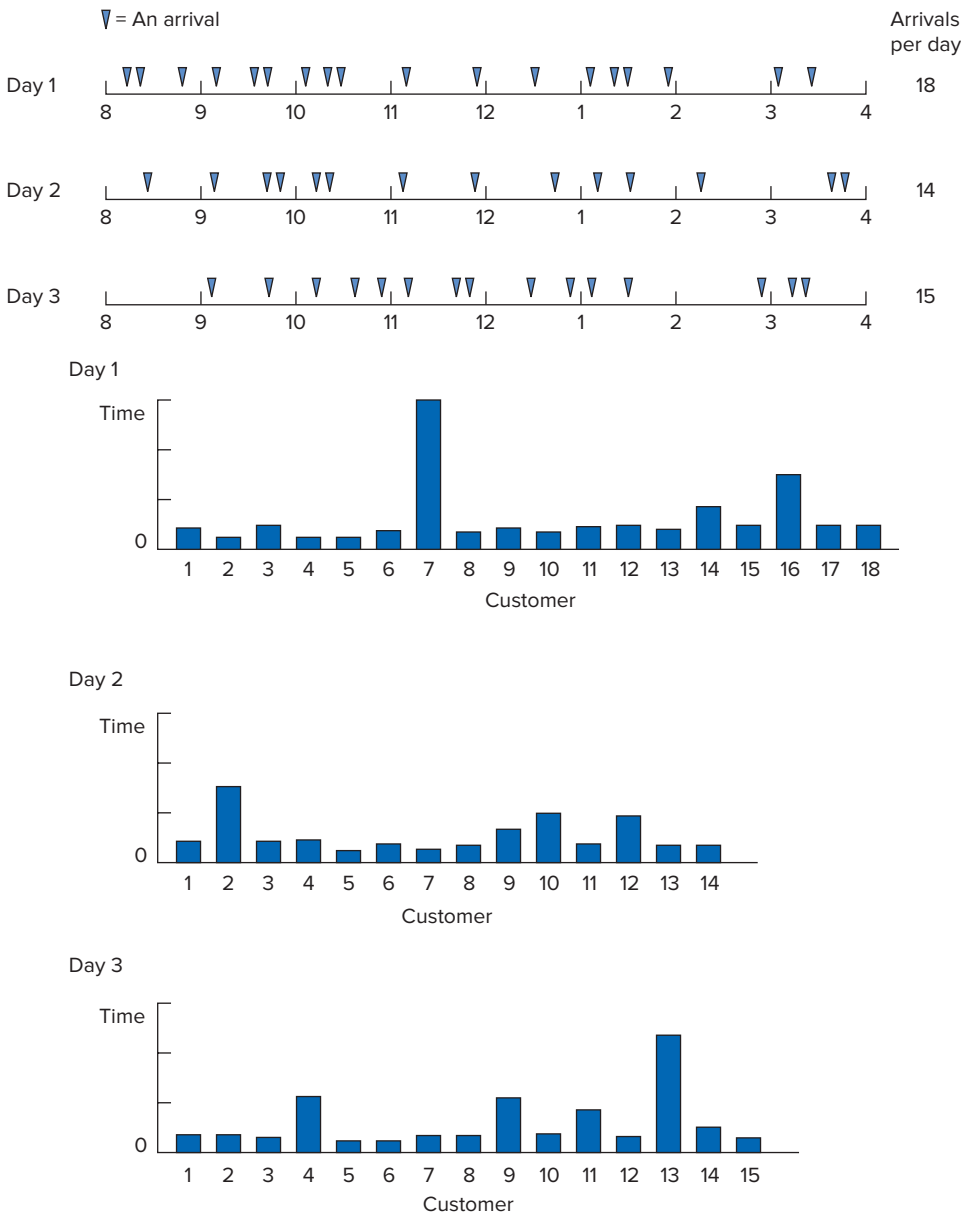

FIGURE 18.5
Poisson arrivals and exponential service times

A. Customer arrivals

B. Service times

service rate is Poisson. Similarly, if the customer arrival rate is Poisson, then the interarrival time (i.e., the time between arrivals) is exponential. For example, if a service facility can process 12 customers per hour (rate), average service time is five minutes. And if the arrival rate is 10 per hour, then the average time between arrivals is six minutes.

The models described here generally require that arrival and service rates lend themselves to description using a Poisson distribution or, equivalently, that interarrival and service times lend themselves to description using a negative exponential distribution. In practice, it is necessary to verify that these assumptions are met. Sometimes this is done by collecting data and plotting them, although the preferred approach is to use a chi-square goodness-of-fit test for that purpose. A discussion of the chi-square test is beyond the scope of this text, but most basic statistics textbooks cover the topic.

Research has shown that these assumptions are often appropriate for customer arrivals but less likely to be appropriate for service. In situations where the assumptions are not reasonably satisfied, the alternatives would be to (1) develop a more suitable model, (2) search for a better (and usually more complex) existing model, or (3) resort to computer simulation. Each of these alternatives requires more effort or cost than the ones presented here.

The models in this chapter assume customers are patient, that is, that customers enter the waiting line and remain until they are served. Other possibilities are that (1) waiting customers grow impatient and leave the line (*reneging*); (2) customers switch to another line (*jockeying*); or (3) upon arriving, customers decide the line is too long and, therefore, do not enter the line (*balking*).

Queue Discipline

Queue discipline The order in which customers are processed.

Queue discipline refers to the order in which customers are processed. All but one of the models to be described shortly assume that service is provided on a *first-come, first-served* basis. This is perhaps the most commonly encountered rule. There is first-come service at banks, stores, theaters, restaurants, four-way stop signs, registration lines, and so on. Examples of systems that do not serve on a first-come basis include hospital emergency rooms, rush orders in a factory, supermarkets that have multiple checkout lines, and mainframe computer processing of jobs. In these and similar situations, customers do not all represent the same waiting costs; those with the highest costs (e.g., the most seriously ill) are processed first, even though other customers may have arrived earlier.

18.5 MEASURES OF WAITING-LINE PERFORMANCE

LO18.3 What metrics are used to help managers analyze waiting lines?

The operations manager typically looks at five measures when evaluating existing or proposed service systems. They relate to potential customer dissatisfaction and costs:

1. The average number of customers waiting, either in line or in the system
2. The average time customers wait, either in line or in the system
3. System utilization, which refers to the percentage of capacity utilized
4. The implied cost of a given level of capacity and its related waiting line
5. The probability that an arrival will have to wait for service

Of these measures, system utilization bears some elaboration. It reflects the extent to which the servers are busy rather than idle. On the surface, it might seem that the operations manager would want to seek 100 percent utilization. However, as Figure 18.6 illustrates, increases in system utilization are achieved at the expense of increases in both the length of the waiting line and the average waiting time. In fact, these values become exceedingly large as utilization approaches 100 percent. The implication is that under normal circumstances, 100 percent utilization is not a realistic goal. Even if it were, 100 percent utilization of service personnel is not good; they need some slack time. Thus, instead, the operations manager should try to achieve a system that minimizes the sum of waiting costs and capacity costs.

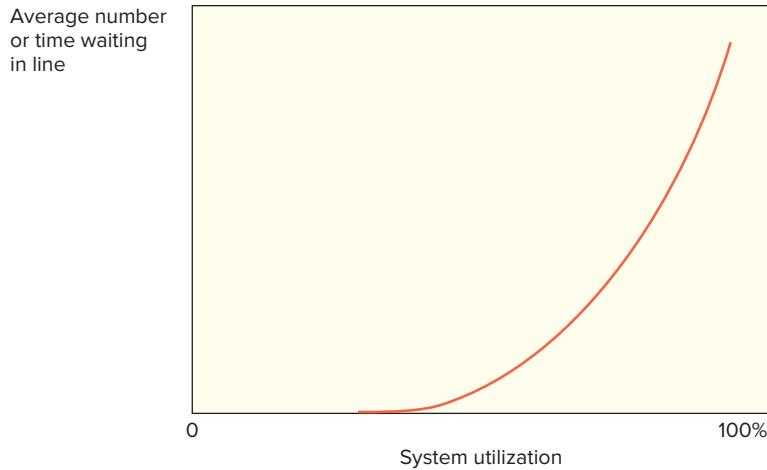
**FIGURE 18.6**

The average number waiting in line and the average time customers wait in line increase exponentially as the system utilization increases.

18.6 QUEUING MODELS: INFINITE-SOURCE

Many queuing models are available for a manager or analyst to choose from. The discussion here includes four of the most basic and most widely used models. The purpose is to provide an exposure to a range of models rather than an extensive coverage of the field. All assume a Poisson arrival rate. Moreover, the models pertain to a system operating under *steady-state* conditions; that is, they assume the average arrival and service rates are stable (e.g., the opening rush at a store is over). The four models described are:

1. Single server, exponential service time
2. Single server, constant service time
3. Multiple servers, exponential service time
4. Multiple priority service, exponential service time

Note that the terms *server* and *channel* mean the same thing. To facilitate your use of waiting-line models, Table 18.1 provides a list of the symbols used for the infinite-source models.

Symbol	Represents
λ	Customer arrival rate
μ	Service rate per server
L_q	The average number of customers waiting for service
L_s	The average number of customers in the system (waiting and/or being served)
r	The average number of customers being served
ρ	The system utilization
W_q	The average time customers wait in line
W_s	The average time customers spend in the system (waiting in line plus service time)
$1/\mu$	Service time
P_0	The probability of zero units in the system
P_n	The probability of n units in the system
M	The number of servers
L_{\max}	The maximum expected number waiting in line

TABLE 18.1

Infinite-source symbols

Basic Relationships

Certain basic relationships hold for all infinite-source models. Knowledge of these can be very helpful in deriving desired performance measures, given a few key values. The following are the basic relationships:

Note: The arrival and service rates, represented by λ and M , must be in the same units (e.g., customers per hour, customers per minute).

System utilization: This reflects the ratio of demand (as measured by the arrival rate) to supply or capacity (as measured by the product of the number of servers, M , and the service rate, μ).

$$\rho = \frac{\lambda}{M\mu} \tag{18-1}$$

The average number of customers being served:

$$r = \frac{\lambda}{\mu} \tag{18-2}$$

For nearly all queuing systems, there is a relationship between the average time a unit spends in the system or queue and the average number of units in the system or queue. According to Little’s law, for a stable system, the average number of customers in line or in the system is equal to the average customer arrival rate multiplied by the average time in line or in the system. That is,

$$L_s = \lambda W_s \quad \text{and} \quad L_q = \lambda W_q$$

The implications of this are important to analysis of waiting lines. The relationships are independent of any probability distribution and require no assumptions about which customers arrive or are serviced, or the order in which they are served. It also means that knowledge of any two of the three variables can be used to obtain the third variable. For example, knowing the arrival rate and the average number in line, one can solve for the average waiting time.

The average number of customers

Waiting in line for service: L_q [Model dependent. Obtain using a table or formula.]

$$\text{In the system (line plus being served): } L_s = L_q + r \tag{18-3}$$

The average time customers are

$$\text{Waiting in line: } W_q = \frac{L_q}{\lambda} \tag{18-4}$$

$$\text{In the system: } W_s = W_q + \frac{1}{\mu} = \frac{L_s}{\lambda} \tag{18-5}$$

All infinite-source models require that system utilization be less than 1.0; the models apply only to underloaded systems.

The average number waiting in line, L_q , is a key value because it is a determinant of some of the other measures of system performance, such as the average number in the system, the average time in line, and the average time in the system. Hence, L_q will usually be one of the first values you will want to determine in problem solving.

Figure 18.7 can help you relate the symbols to the basic relationships in a queuing system.

FIGURE 18.7
Basic relationships

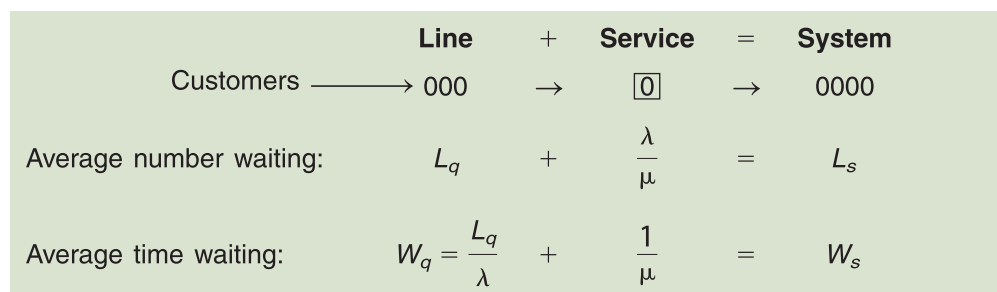

Determining the Arrival Rate and the Service Rate

EXAMPLE 1

excel

mhhe.com/stevenson14e

Customers arrive at a bakery at an average rate of 18 per hour on weekday mornings. The arrival distribution can be described by a Poisson distribution with a mean of 18. Each clerk can serve a customer in an average of three minutes. This time can be described by an exponential distribution with a mean of 3.0 minutes.

- What are the arrival and service rates?
- Compute the average number of customers being served at any time.
- Suppose it has been determined that the average number of customers waiting in line is 8.1. Compute the average number of customers in the system (i.e., waiting in line or being served), the average time customers wait in line, and the average time in the system.
- Determine the system utilization for $M = 1, 2,$ and 3 servers.

SOLUTION

- The arrival rate is given in the problem: $\lambda = 18$ customers per hour. Change the service time to a comparable hourly rate. Thus,

$$60 \text{ minutes per hour} / 3 \text{ minutes per customer} = \mu = 20 \text{ customers per hour}$$

- $r = \frac{\lambda}{\mu} = \frac{18}{20} = .90$ customer

- Given: $L_q = 8.1$ customers

$$L_s = L_q + r = 8.1 + .90 = 9.0 \text{ customers}$$

$$W_q = \frac{L_q}{\lambda} = \frac{8.1}{18} = .45 \text{ hour}$$

$W_s =$ Waiting in line plus service

$$= W_q + \frac{1}{\mu} = .45 + \frac{1}{20} = .50 \text{ hour}$$

- System utilization is $\rho = \frac{\lambda}{M\mu}$.

$$\text{For } M = 1, \rho = \frac{18}{1(20)} = .90$$

$$\text{For } M = 2, \rho = \frac{18}{2(20)} = .45$$

$$\text{For } M = 3, \rho = \frac{18}{3(20)} = .30$$

Note that as the system capacity as measured by $M\mu$ increases, the system utilization for a given arrival rate decreases.

Single Server, Exponential Service Time, M/M/1¹

The simplest model involves a system that has one server (or a single crew). The queue discipline is first-come, first-served, and it is assumed that the customer arrival rate can be approximated by a Poisson distribution, and the service time determined by a negative exponential distribution. There is no limit on length of queue.

Table 18.2 lists the formulas for the single-server model, which should be used in conjunction with Formulas 18–1 through 18–5.

¹This notation is commonly used to specify waiting-line models. The first symbol refers to arrivals, the second to service, and the third to the number of servers. M stands for a rate that can be described by a Poisson distribution or, equivalently, a time that can be described by an exponential distribution. Hence, M/M/1 indicates a Poisson arrival rate, a Poisson service rate, and one server. The symbol D is used to denote a deterministic (i.e., constant) service rate. Thus, the notation M/D/1 would indicate the arrival rate is Poisson and the service rate is constant. Finally, the notation M/M/S would indicate multiple servers.

TABLE 18.2

Formulas for basic single-server model

Performance Measure	Equation	
Average number in line	$L_q = \frac{\lambda^2}{\mu(\mu - \lambda)}$	(18-6)
Probability of zero units in the system	$P_0 = 1 - \left(\frac{\lambda}{\mu}\right)$	(18-7)
Probability of n units in the system	$P_n = P_0 \left(\frac{\lambda}{\mu}\right)^n$	(18-8a)
Probability of less than n units in the system	$P_{<n} = 1 - \left(\frac{\lambda}{\mu}\right)^n$	(18-8b)

EXAMPLE 2



mhhe.com/stevenson14e

Computing Project Metrics for a Single Channel System

An airline is planning to open a satellite ticket desk in a new shopping plaza, staffed by one ticket agent. It is estimated that requests for tickets and information will average 15 per hour, and requests will have a Poisson distribution. Service time is assumed to be exponentially distributed. Previous experience with similar satellite operations suggests that mean service time should average about three minutes per request. Determine each of the following:

- System utilization
- Percentage of time the server (agent) will be idle
- The expected number of customers waiting to be served
- The average time customers will spend in the system
- The probability of zero customers in the system and the probability of four customers in the system

SOLUTION

 $\lambda = 15$ customers per hour

$$\mu = \frac{1}{\text{Service time}} = \frac{1 \text{ customer}}{3 \text{ minutes}} \times 60 \text{ minutes per hour} \\ = 20 \text{ customers per hour}$$

- $\rho = \frac{\lambda}{M\mu} = \frac{15}{1(20)} = .75$
- Percentage idle time = $1 - \rho = 1 - .75 = .25$, or 25 percent
- $L_q = \frac{\lambda^2}{\mu(\mu - \lambda)} = \frac{15^2}{20(20 - 15)} = 2.25$ customers
- $W_s = \frac{L_q}{\lambda} + \frac{1}{\mu} = \frac{2.25}{15} + \frac{1}{20} = .20$ hour, or 12 minutes
- $P_0 = 1 - \frac{\lambda}{\mu} = 1 - \frac{15}{20} = .25$ and $P_4 = P_0 \left(\frac{\lambda}{\mu}\right)^4 = .25 \left(\frac{15}{20}\right)^4 = .079$

Single Server, Constant Service Time, M/D/1

LO18.4 What very important lesson does the constant service time model provide for managers?

As noted previously, waiting lines are a consequence of random, highly variable arrival and service rates. If a system can reduce or eliminate the variability of either or both, it can shorten waiting lines noticeably. A case in point is a system with constant service time. The effect of a constant service time is to cut in half the average number of customers waiting in line.

$$L_q = \frac{\lambda^2}{2\mu(\mu - \lambda)} \quad (18-9)$$

The average time customers spend waiting in line is also cut in half. Similar improvements can be realized by smoothing arrival times (e.g., by use of appointments). Thus, anything a manager can do to reduce service time variability will reduce the number waiting and the time waiting.

Computing the Average Number in Line and the Time in Line for a Constant Service Time

EXAMPLE 3



Wanda’s Car Wash & Dry is an automatic, five-minute operation with a single bay. On a typical Saturday morning, cars arrive at a mean rate of eight per hour, with arrivals tending to follow a Poisson distribution. Find the following:

- a. The average number of cars in line
- b. The average time cars spend in line and service

SOLUTION

$\lambda = 8$ cars per hour
 $\mu = 1$ per 5 minutes, or 12 per hour

a. $L_q = \frac{\lambda^2}{2\mu(\mu - \lambda)} = \frac{8^2}{2(12)(12 - 8)} = .667$ car

b. $W_s = \frac{L_q}{\lambda} + \frac{1}{\mu} = \frac{.667}{8} + \frac{1}{12} = .167$ hour, or 10 minutes

Multiple Servers, M/M/S

A multiple-server system exists whenever two or more servers are working *independently* to provide service to customer arrivals. Use of the model involves the following assumptions:

- A Poisson arrival rate and exponential service time.
- Servers all work at the same average rate.
- Customers form a single waiting line (in order to maintain first-come, first-served processing).

Formulas for the multiple-server model are listed in Table 18.3. Obviously, the multiple-server formulas are more complex than the single-server formulas, especially the formulas for L_q and P_0 . These formulas are shown primarily for completeness; you can actually determine their values using Table 18.4, which gives values of L_q and P_0 for selected values of λ/μ and M .

To use Table 18.4, compute the value of λ/μ and round according to the number of decimal places given for that ratio in the table. Then, simply read the values of L_q and P_0 for the appropriate number of channels, M . For instance, if $\lambda/\mu = 0.50$ and $M = 2$, the table provides a value of 0.033 for L_q and a value of .600 for P_0 . These values can then be used to compute

Performance Measure	Equation
Average number in line	$L_q = \frac{\lambda\mu \left(\frac{\lambda}{\mu}\right)^M}{(M-1)!(M\mu - \lambda)^2} P_0 \tag{18-10}$
Probability of zero units in the system	$P_0 = \left[\sum_{n=0}^{M-1} \frac{\left(\frac{\lambda}{\mu}\right)^n}{n!} + \frac{\left(\frac{\lambda}{\mu}\right)^M}{M! \left(1 - \frac{\lambda}{M\mu}\right)} \right]^{-1} \tag{18-11}$
Average waiting time for a customer who has to wait	$W_q = \frac{1}{M\mu - \lambda} \tag{18-12}$
Probability that an arrival will have to wait for service	$P_w = \frac{W_q}{W_s} \tag{18-13}$

TABLE 18.3
Multiple-server queuing formulas

TABLE 18.4

Infinite-source values for L_q and P_0 given λ/μ and M

λ/μ	M	L_q	P_0	λ/μ	M	L_q	P_0	λ/μ	M	L_q	P_0
0.15	1	0.026	.850	1.1	2	0.477	.290		6	0.021	.100
	2	0.001	.860		3	0.066	.327	2.4	3	2.589	.056
0.20	1	0.050	.800		4	0.011	.332		4	0.431	.083
	2	0.002	.818	1.2	2	0.675	.250		5	0.105	.089
0.25	1	0.083	.750		3	0.094	.294		6	0.027	.090
	2	0.004	.778		4	0.016	.300		7	0.007	.091
0.30	1	0.129	.700		5	0.003	.301	2.5	3	3.511	.045
	2	0.007	.739	1.3	2	0.951	.212		4	0.533	.074
0.35	1	0.188	.650		3	0.130	.264		5	0.130	.080
	2	0.011	.702		4	0.023	.271		6	0.034	.082
0.40	1	0.267	.600		5	0.004	.272		7	0.009	.082
	2	0.017	.667	1.4	2	1.345	.176	2.6	3	4.933	.035
0.45	1	0.368	.550		3	0.177	.236		4	0.658	.065
	2	0.024	.633		4	0.032	.245		5	0.161	.072
	3	0.002	.637		5	0.006	.246		6	0.043	.074
0.50	1	0.500	.500	1.5	2	1.929	.143		7	0.011	.074
	2	0.033	.600		3	0.237	.211	2.7	3	7.354	.025
	3	0.003	.606		4	0.045	.221		4	0.811	.057
0.55	1	0.672	.450		5	0.009	.223		5	0.198	.065
	2	0.045	.569	1.6	2	2.844	.111		6	0.053	.067
	3	0.004	.576		3	0.313	.187		7	0.014	.067
0.60	1	0.900	.400		4	0.060	.199	2.8	3	12.273	.016
	2	0.059	.538		5	0.012	.201		4	1.000	.050
	3	0.006	.548	1.7	2	4.426	.081		5	0.241	.058
0.65	1	1.207	.350		3	0.409	.166		6	0.066	.060
	2	0.077	.509		4	0.080	.180		7	0.018	.061
	3	0.008	.521		5	0.017	.182	2.9	3	27.193	.008
0.70	1	1.633	.300	1.8	2	7.674	.053		4	1.234	.044
	2	0.098	.481		3	0.532	.146		5	0.293	.052
	3	0.011	.495		4	0.105	.162		6	0.081	.054
0.75	1	2.250	.250		5	0.023	.165		7	0.023	.055
	2	0.123	.455	1.9	2	17.587	.026	3.0	4	1.528	.038
	3	0.015	.471		3	0.688	.128		5	0.354	.047
0.80	1	3.200	.200		4	0.136	.145		6	0.099	.049
	2	0.152	.429		5	0.030	.149		7	0.028	.050
	3	0.019	.447		6	0.007	.149		8	0.008	.050
0.85	1	4.817	.150	2.0	3	0.889	.111	3.1	4	1.902	.032
	2	0.187	.404		4	0.174	.130		5	0.427	.042
	3	0.024	.425		5	0.040	.134		6	0.120	.044
	4	0.003	.427		6	0.009	.135		7	0.035	.045
0.90	1	8.100	.100	2.1	3	1.149	.096		8	0.010	.045
	2	0.229	.379		4	0.220	.117	3.2	4	2.386	.027
	3	0.030	.403		5	0.052	.121		5	0.513	.037
	4	0.004	.406		6	0.012	.122		6	0.145	.040
0.95	1	18.050	.050	2.2	3	1.491	.081		7	0.043	.040
	2	0.277	.356		4	0.277	.105		8	0.012	.041
	3	0.037	.383		5	0.066	.109	3.3	4	3.027	.023
	4	0.005	.386		6	0.016	.111		5	0.615	.033
1.0	2	0.333	.333	2.3	3	1.951	.068		6	0.174	.036
	3	0.045	.364		4	0.346	.093		7	0.052	.037
	4	0.007	.367		5	0.084	.099		8	0.015	.037

(continued)

TABLE 18.4
(concluded)

λ/μ	M	L_q	P_0	λ/μ	M	L_q	P_0	λ/μ	M	L_q	P_0
3.4	4	3.906	.019	4.3	7	0.289	.130	5.2	6	4.301	.003
	5	0.737	.029		8	0.097	.013		7	1.081	.005
	6	0.209	.032		9	0.033	.014		8	0.368	.005
	7	0.063	.033		10	0.011	.014		9	0.135	.005
	8	0.019	.033	4.4	5	5.268	.006		10	0.049	.005
3.5	4	5.165	.015		6	1.078	.010		11	0.018	.006
	5	0.882	.026		7	0.337	.012	5.3	6	5.303	.003
	6	0.248	.029		8	0.114	.012		7	1.249	.004
	7	0.076	.030		9	0.039	.012		8	0.422	.005
	8	0.023	.030		10	0.013	.012		9	0.155	.005
	9	0.007	.030	4.5	5	6.862	.005		10	0.057	.005
3.6	4	7.090	.011		6	1.265	.009		11	0.021	.005
	5	1.055	.023		7	0.391	.010		12	0.007	.005
	6	0.295	.026		8	0.134	.011	5.4	6	6.661	.002
	7	0.019	.027		9	0.046	.011		7	1.444	.004
	8	0.028	.027		10	0.015	.011		8	0.483	.004
	9	0.008	.027	4.6	5	9.289	.004		9	0.178	.004
3.7	4	10.347	.008		6	1.487	.008		10	0.066	.004
	5	1.265	.020		7	0.453	.009		11	0.024	.005
	6	0.349	.023		8	0.156	.010		12	0.009	.005
	7	0.109	.024		9	0.054	.010	5.5	6	8.590	.002
	8	0.034	.025		10	0.018	.010		7	1.674	.003
	9	0.010	.025	4.7	5	13.382	.003		8	0.553	.004
3.8	4	16.937	.005		6	1.752	.007		9	0.204	.004
	5	1.519	.017		7	0.525	.008		10	0.077	.004
	6	0.412	.021		8	0.181	.009		11	0.028	.004
	7	0.129	.022		9	0.064	.009		12	0.010	.004
	8	0.041	.022		10	0.022	.009	5.6	6	11.519	.001
	9	0.013	.022	4.8	5	21.641	.002		7	1.944	.003
3.9	4	36.859	.002		6	2.071	.006		8	0.631	.003
	5	1.830	.015		7	0.607	.008		9	0.233	.004
	6	0.485	.019		8	0.209	.008		10	0.088	.004
	7	0.153	.020		9	0.074	.008		11	0.033	.004
	8	0.050	.020		10	0.026	.008		12	0.012	.004
	9	0.016	.020	4.9	5	46.566	.001	5.7	6	16.446	.001
4.0	5	2.216	.013		6	2.459	.005		7	2.264	.002
	6	0.570	.017		7	0.702	.007		8	0.721	.003
	7	0.180	.018		8	0.242	.007		9	0.266	.003
	8	0.059	.018		9	0.087	.007		10	0.102	.003
	9	0.019	.018		10	0.031	.007		11	0.038	.003
4.1	5	2.703	.011		11	0.011	.007		12	0.014	.003
	6	0.668	.015	5.0	6	2.938	.005	5.8	6	26.373	.001
	7	0.212	.016		7	0.810	.006		7	2.648	.002
	8	0.070	.016		8	0.279	.006		8	0.823	.003
	9	0.023	.017		9	0.101	.007		9	0.303	.003
4.2	5	3.327	.009		10	0.036	.007		10	0.116	.003
	6	0.784	.013		11	0.013	.007		11	0.044	.003
	7	0.248	.014	5.1	6	3.536	.004		12	0.017	.003
	8	0.083	.015		7	0.936	.005	5.9	6	56.300	.000
	9	0.027	.015		8	0.321	.006		7	3.113	.002
	10	0.009	.015		9	0.117	.006		8	0.939	.002
4.3	5	4.149	.008		10	0.042	.006		9	0.345	.003
	6	0.919	.012		11	0.015	.006		10	0.133	.003

other measures of system performance. Note that the formulas in Table 18.3 and the values in Table 18.4 yield *average* amounts (i.e., expected values). Note also that Table 18.4 can be used for some single-channel problems (i.e., $M = 1$) as well.

EXAMPLE 4

Excel

mhhe.com/stevenson14e

Determining Values for Metrics When There Are Multiple Service Channels

Alpha Taxi and Hauling Company has seven cabs stationed at the airport. The company has determined that during the late-evening hours on weeknights, customers request cabs at a rate that follows the Poisson distribution, with a mean of 6.6 per hour. Service time is exponential, with a mean of 50 minutes per customer. Assume there is one customer per cab. Find each of the performance measures listed in Table 18.3 and the system utilization.



Stephen Chernin/Getty

SOLUTION

$$\lambda = 6.6 \text{ per hour } M = 7 \text{ cabs (servers)}$$

$$\begin{aligned} \mu &= \frac{1 \text{ customer per trip}}{50 \text{ minutes per trip} \div 60 \text{ minutes per hour}} \\ &= 1.2 \text{ customers per hour per cab} \\ \lambda/\mu &= 5.5 \end{aligned}$$

From Table 18.4 with $M = 7$,

$$L_q = 1.674 \text{ customers and } P_0 = .003$$

$$W_a = \frac{1}{M\mu - \lambda} = \frac{1}{7(1.2) - 6.6} = .556 \text{ hour, or } 33.36 \text{ minutes}$$

$$W_q = \frac{L_q}{\lambda} = \frac{1.674}{6.6} = .2536 \text{ hour, or } 15.22 \text{ minutes}$$

$$P_w = \frac{w_q}{w_a} = \frac{.2536}{.556} = .456$$

$$\rho = \frac{\lambda}{M\mu} = \frac{6.6}{7(1.2)} = .786$$

The Excel template also can be used to solve Example 4. After entering $\lambda = 6.6$ and $\mu = 1.2$ at the top of the template, the queuing statistics for 7 servers are shown in the first column of the table in the template. The template also provides queuing statistics for 8 through 12 servers for comparison, although these are not required for this example. In addition, the template can be used to increment λ , μ , or the number of servers to further investigate the queuing system.

The process also can be worked in reverse; that is, an analyst can determine the capacity needed to achieve specified levels of various performance measures. This approach is illustrated in the following example.

EXAMPLE 5

Excel

mhhe.com/stevenson14e

Determining the Minimum Number of Servers Needed to Achieve a Specified Average Waiting Time

Alpha Taxi and Hauling also plans to have cabs at a new rail station. The expected arrival rate is 4.8 customers per hour, and the service rate (including return time to the rail station) is expected to be 1.5 per hour. How many cabs will be needed to achieve an average time in line of 20 minutes or less?

SOLUTION

$$\lambda = 4.8 \text{ customers per hour}$$

$$\mu = 1.5 \text{ customers per hour}$$

$$M = ?$$

$$r = \frac{\lambda}{\mu} = \frac{4.8}{1.5} = 3.2 \text{ customers}$$

$$W_q \text{ (desired)} = 20 \text{ minutes, or } .333 \text{ hour}$$

Using $L_q = \lambda \times W_q$, you can solve for L_q : $4.8/\text{hour} \times (.333 \text{ hour}) = 1.6$ customers. Thus, the average number waiting should not exceed 1.6 customers. Referring to Table 18.4, with $r = 3.2$, $L_q = 2.386$ for $M = 4$, and 0.513 for $M = 5$. Hence, five cabs will be needed.

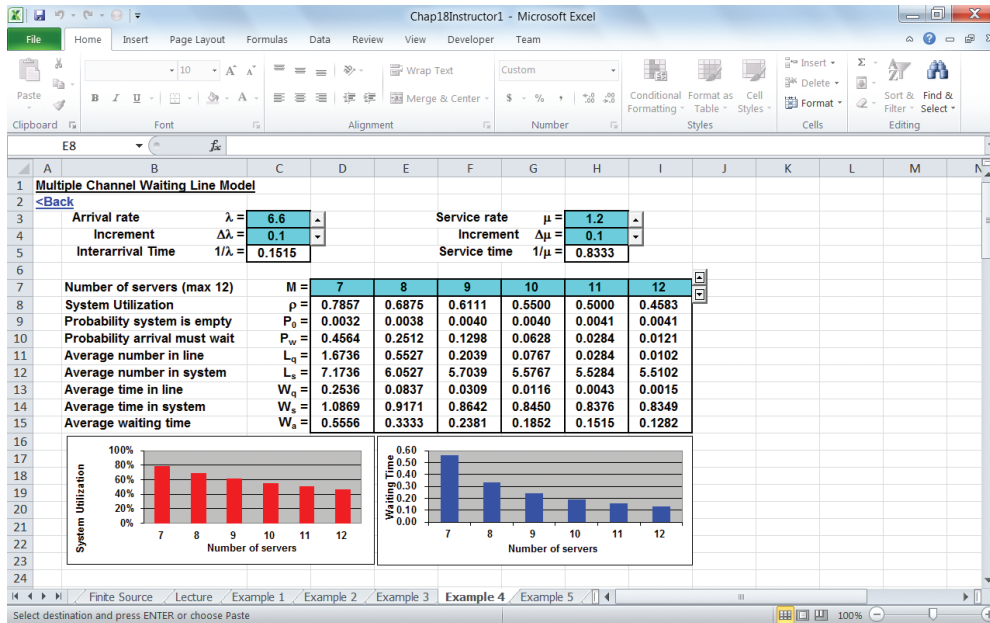

excel
mhhe.com/stevenson14e

Source: Microsoft

Finally, note that in a situation where there are multiple servers, each with a separate line (e.g., a supermarket), each line would be treated as a single-server system.

Cost Analysis

The design of a service system often reflects the desire of management to balance the cost of capacity with the expected cost of customers waiting in the system. (Note that customer waiting cost refers to the costs incurred by the organization due to customer waiting.) For example, in designing loading docks for a warehouse, the cost of docks plus loading crews must be balanced against the cost of trucks and drivers that will be in the system, both while waiting to be unloaded and while actually being unloaded. Similarly, the cost of having a mechanic wait for tools at a tool crib must be balanced against the cost of servers at the crib. In cases where the customers are not employees (e.g., retail sales), the costs can include lost sales when customers refuse to wait, the cost of providing waiting space, and the cost of added congestion (lost business, shoplifting).

The optimal capacity (usually in terms of number of channels) is one that minimizes the sum of customer waiting costs and capacity or server costs. Thus, the goal is:

$$\text{Minimize Total cost} = \text{Customer waiting cost} + \text{Capacity cost}$$

FIGURE 18.8

As the number of servers is increased, the optimal number of servers becomes apparent when the total cost begins to increase.

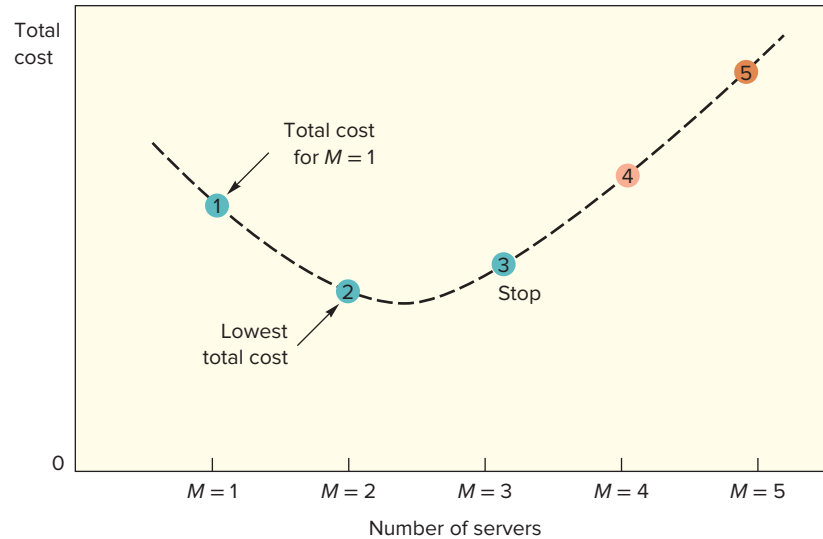

The simplest approach to a cost analysis involves computing *system* costs—that is, computing the costs for customers in the system and total capacity cost. Capacity cost typically is a function of the number of servers.

An iterative process is used to identify the capacity size that will minimize total costs. Capacity is incremented one unit at a time (e.g., increase the number of channels by one), and the total cost is computed at each increment. Because the total cost curve is U-shaped, usually the total cost will initially decrease as capacity is increased, and then it will eventually begin to increase. Once it begins to increase, additional increases in capacity will cause it to continue to increase. Hence, once that occurs, the optimal capacity size can be readily identified. Figure 18.8 illustrates this approach. Find the total cost for $M = 1$, then $M = 2$, $M = 3$, and continue as long as the total costs continue to decline. However, as soon as the total cost begins to rise, as it does at $M = 3$ in Figure 18.8, the search can be stopped. The optimal solution is apparent; it is $M = 2$. There would be no need to continue computing total costs for additional servers because, as you can see, the total costs will continue to increase as more servers are added. *Note:* Although in many instances the starting point is $M = 1$, the general rule is to begin at the smallest number of servers for which the system is underloaded (i.e., the system utilization is < 1.00).

The computation of customer waiting costs is based on the average *number* of customers in the *system*. This is perhaps not intuitively obvious; instead, it might seem that customer waiting *time* in the system would be more appropriate. However, that approach would pertain to only *one* customer—it would not convey information concerning *how many* customers would wait that long. Obviously, an average of five customers waiting would involve a lower waiting cost than an average of nine. Therefore, it is necessary to focus on the *number* waiting. Moreover, if, on average, two customers are in the system, this is equivalent to having *exactly* two customers in the system at all times, even though in reality there will be times when zero, one, two, three, or more customers are in the system.

EXAMPLE 6**Determining the Optimal Number of Servers to Minimize Total Cost**

excel
mhhe.com/stevenson14e

Trucks arrive at a warehouse at a rate of 15 per hour during business hours. Crews can unload the trucks at a rate of 5 per hour. The high unloading rate is due to cargo being containerized. Recent changes in wage rates have caused the warehouse manager to reexamine the question of how many crews to use. The new rates are: Crew and dock cost is \$100 per hour; truck and driver cost is \$120 per hour.

SOLUTION

(L_q values are from Table 18.4, using $\frac{\lambda}{\mu} = \frac{15}{5} = 3.0$.)

Number of Crews (M)	Crew and Dock Cost	Average Number in System $[L_s = L_q + \frac{\lambda}{\mu}]$	$[L_s \times \$120]$ Driver/Truck Cost	Total Cost
4	\$400	$1.528 + 3.0 = 4.528$	\$543.36	\$ 943.36
5	500	$.354 + 3.0 = 3.354$	402.48	902.48 (minimum)
6	600	$.099 + 3.0 = 3.099$	371.88	971.88
7	700	$.028 + 3.0 = 3.028$	363.36	1,063.36

Five crews will minimize the total cost. Because the total cost will continue to increase once the minimum is reached, it is not really necessary to compute total costs for crew sizes larger than six, because total cost increased as the crew size was increased from five to six, indicating that a crew of five is optimal.

One additional point should be made concerning cost analysis. Because both customer waiting costs and capacity costs often reflect estimated amounts, the apparent optimal solution may not represent the true optimum. One ramification of this is that when computations are shown to the nearest penny, or even the nearest dollar, the total cost figures may seem to imply a higher degree of precision than is really justified by the cost estimates. This is compounded by the fact that arrival and service rates may either be approximations or not be exactly represented by the Poisson/exponential distribution. Another ramification is that if cost estimates can be obtained as *ranges* (e.g., customer waiting cost is estimated to range between \$40 and \$50 per hour), total costs should be computed using both ends of the range to see whether the optimal solution is affected. If it is, management must decide whether to expend additional effort to obtain more precise cost estimates or choose one of the two indicated optimal solutions. Management would most likely choose to employ the latter strategy if there were little disparity between total costs of various capacity levels close to the indicated optimal solutions.

Maximum Line Length

Another question that often comes up in capacity planning is the amount of space to allocate for waiting lines. Theoretically, with an infinite population source, the waiting line can become infinitely long. This implies that no matter how much space is allocated for a waiting line, one can ever be completely sure the space requirements won't exceed that amount. Nonetheless, as a practical matter, one can determine a line length that will not be exceeded a specified proportion of the time. For instance, an analyst may wish to know the length of line that will probably not be exceeded 98 percent of the time, or perhaps 99 percent of the time, and use that number as a planning value.

The approximate line length that will satisfy a specified percentage can be determined by solving the following equation for L_{max} :

$$L_{max} = \frac{\log K}{\log \rho} \quad \text{or} \quad \frac{\ln K}{\ln \rho} \tag{18-14}$$

where

$$K = \frac{1 - \text{Specified percentage}}{L_q(1 - \rho)}$$

The resulting value of L_{max} will not usually be an integer. Generally, round *up* to the next integer and treat the value as L_{max} . However, as a practical matter, if the computed

value of L_{\max} is less than .10 above the next lower integer, round down. Thus, 15.2 would be rounded to 16, but 15.06 would be rounded to 15.

EXAMPLE 7**Determining the Maximum Line Length**

Determine the maximum length of a waiting line for specified probabilities of 95 percent and 98 percent, for a system in which $M = 2$, $\lambda = 8$ per hour, and $\mu = 5$ per hour.

SOLUTION

$$r = \frac{8}{5} = 1.6 \quad \text{and} \quad \rho = \frac{8}{2(5)} = .80$$

From Table 18.4, $L_q = 2.844$ customers. For 95 percent, using Formula 18-14:

$$K = \frac{1 - .95}{2.844(1 - .80)} = .088$$

$$L_{\max} = \frac{\ln .088}{\ln .80} = \frac{-2.4304}{-.2231} = 10.89, \text{ which rounds to } 11$$

For 98 percent:

$$K = \frac{1 - .98}{2.844(1 - .80)} = .035$$

$$L_{\max} = \frac{\ln .035}{\ln .80} = \frac{-3.352}{-.2231} = 15.02, \text{ which rounds to } 15$$

Multiple Priorities

In many queuing systems, processing occurs on a first-come, first-served basis. However, there are situations in which that rule is inappropriate. The reason is that the waiting cost or penalty incurred is not the same for all customers. In a hospital emergency waiting room, a wide variety of injuries and illnesses needs treatment. Some may be minor (e.g., sliver in a finger) and others may be much more serious, even life-threatening. It is more reasonable to treat the most serious cases first, letting the nonserious cases wait until all serious cases have been treated. Similarly, computer processing of jobs often follows rules other than first-come, first-served (e.g., shortest job first). In such cases, a **multiple-priority model** is useful for describing customer waiting times.

Multiple-priority model

Customers are processed according to some measure of importance.

In these systems, arriving customers are assigned to one of several *priority classes*, or categories, according to a predetermined assignment method (e.g., in a hospital emergency room, heart attacks, serious injuries, and unconscious persons are assigned to the highest priority class; sprains, minor cuts, bruises, and rashes are assigned to the lowest class; and other problems are assigned to one or more intermediate classes). Customers are then processed by class, highest class first. Within each class, processing is first-come, first-served. Thus, all customers in the highest class would be processed before those in the next lower class, then processing would move to that class, and then to the next lower class. Exceptions would occur only if a higher-priority customer arrived; that customer would be processed *after* the customer currently being processed (i.e., service would not be *preemptive*).

This model incorporates all of the assumptions of the basic multiple-server model except that it uses priority serving instead of first-come, first-served. Arrivals to the system are assigned a priority as they arrive (e.g., highest priority = 1, next priority class = 2, next priority class = 3, and so on). An existing queue might look something like this:

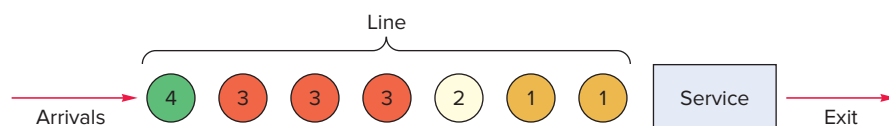

Performance Measure	Formula	Formula Number
System utilization	$\rho = \frac{\lambda}{M\mu}$	(18-15)
Intermediate values (L_q from Table 18.4)	$A = \frac{\lambda}{(1-\rho)L_q}$	(18-16)
	$B_k = 1 - \sum_{c=1}^k \frac{\lambda_c}{M\mu}$ ($B_0 = 1$)	(18-17)
Average waiting time in line for units in k th priority class	$W_k = \frac{1}{A \cdot B_{k-1} \cdot B_k}$	(18-18)
Average time in the system for units in the k th priority class	$W = W_k + \frac{1}{\mu}$	(18-19)
Average number waiting in line for units in the k th priority class	$L_k = \lambda_k \times W_k$	(18-20)

TABLE 18.5
Multiple-server priority service model

Within each class, waiting units are processed in the order in which they arrived (i.e., first-come, first-served). Thus, in this sequence, the first 1 would be processed as soon as a server was available. The second 1 would be processed when that server or another one became available. If, in the interim, another 1 arrived, it would be next in line *ahead of the first 2*. If there were no new arrivals, the only 2 would be processed by the next available server. At that point, if a new 1 or 2 arrived, it would be processed ahead of the 3s and the 4. Conversely, if a new 4 arrived, it would take its place at the end of the line.

Obviously, a unit with a low priority could conceivably wait a rather long time for processing. In some cases, units that have waited more than some specified time are reassigned to a higher priority.

Table 18.5 gives the appropriate formulas for this multiple-channel priority service model. However, due to the extent of computations involved, it is best to use the appropriate Excel template on the website for computations.

Determining System Metrics for a Multiple Priority System

EXAMPLE 8

A machine shop handles tool repairs in a large company. As each job arrives in the shop, it is assigned a priority based on the urgency of the need for that tool. Requests for repair can be described by a Poisson distribution. Arrival rates are: $\lambda_1 = 2$ per hour, $\lambda_2 = 2$ per hour, and $\lambda_3 = 1$ per hour. The service rate is one tool per hour for each server, and there are six servers in the shop. Determine the following information.

- The system utilization
- The average time a tool in each of the priority classes will wait for service
- The average time a tool spends in the system for each priority class
- The average number of tools waiting for repair in each class

$\lambda = \sum \lambda_k = 2 + 2 + 1 = 5$ customers per hour
 $M = 6$ servers
 $\mu = 1$ customer per hour

SOLUTION

Using the Excel template, the solution would appear as follows:

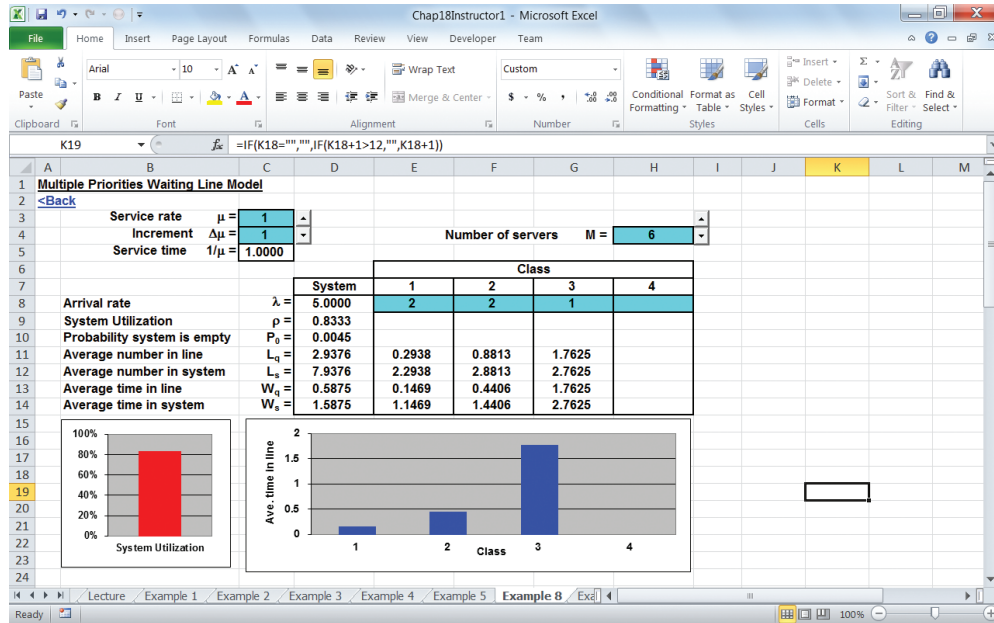

Source: Microsoft

Revising Priorities. If any of the waiting times computed in Example 8 is deemed too long by management (e.g., a waiting time of .147 hour for tools in the first class might be too long), several options are available. One is to increase the number of servers. Another is to attempt to increase the service rate, say, by introducing new methods. If such options are not feasible, another approach is to reexamine the membership of each of the priority classifications, because if some repair requests in the first priority class, for example, can be reassigned to the second priority class, this will tend to decrease the average waiting times for repair jobs in the highest priority classification, simply because the arrival rate of those items will be lower.

EXAMPLE 9

Comparing Waiting Times for the Original and Revised Systems



The manager of the repair shop, after consulting with the managers of the departments that use the shop's services, has revised the list of tools that are given the highest priorities. This is reflected by revised arrival rates. Suppose the revised rates are $\lambda_1 = 1.5$, $\lambda_2 = 2.5$, and λ_3 remains unchanged at 1.0. Determine the following information:

- The system utilization
- The average waiting time for units in each priority class

SOLUTION

$$\lambda = \sum \lambda_k = 1.5 + 2.5 + 1.0 = 5.0 \text{ customers per hour}$$

$$M = 6 \text{ servers}$$

$$\mu = 1 \text{ customer per hour}$$

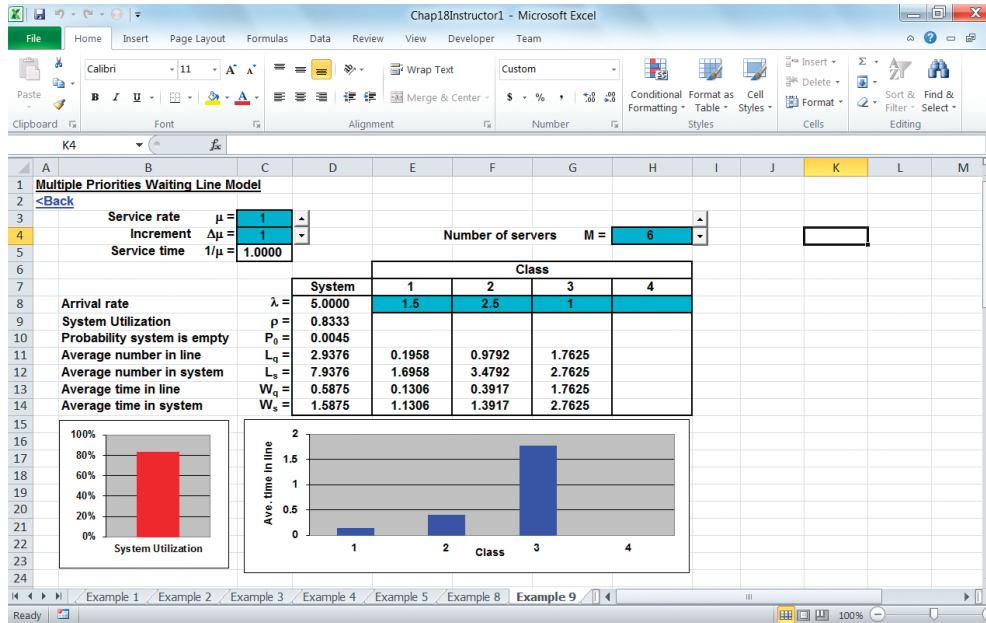

Source: Microsoft

- As shown in the template, the system utilization is still 0.8333.
- $W_1 = 0.1306$, $W_2 = 0.3917$, $W_3 = 1.7625$

Example 9 offers several interesting results. One is that through reduction of the arrival rate of the highest priority class, the average waiting time for units in that class has decreased. In other words, removing some members of the highest class and placing them into the next-lower class reduced the average waiting time for units that remained in the highest class. Note that the average waiting time for the second priority class also was reduced, even though units were added to that class. Although this may appear counterintuitive, it is necessary to recognize that the *total* waiting time (when all arrivals are taken into account) will remain unchanged. We can see this by noticing that the average *number* waiting (see Example 8, part *d*) is $.2938 + .8813 + 1.7625 = 2.9376$. In Example 9, using the average waiting times just computed, the average number waiting in all three classes is:

$$\sum_{k=1}^3 \lambda_k W_k = 1.5(.1306) + 2.5(.3917) + 1.0(1.7625) = 2.9376$$

Aside from a slight difference due to rounding, the totals are the same.

Another interesting observation is that the average waiting time for customers in the third priority class did not change from the preceding example. The reason for this is that the *total* arrival rate for the two higher-priority classes did not change, and the average arrival rate for this class did not change. Hence, units assigned to the lowest class must still contend with a combined arrival rate of 4 for the two higher-priority classes.

18.7 QUEUING MODEL: FINITE-SOURCE

The finite-source model is appropriate for cases in which the calling population is limited to a relatively small number of potential calls. For instance, one person may be responsible for handling breakdowns on 15 machines; thus, the size of the calling population is 15. However, there may be more than one server or channel; for example, due to a backlog of machines awaiting repairs, the manager might authorize an additional person to work on repairs.

TABLE 18.6 Finite-source queuing formulas and notation

Performance Measure	Formulas	Notation*
Service factor	$X = \frac{T}{T + U}$ (18-21)	D = Probability that a customer will have to wait in line
Average number waiting	$L = N(1 - F)$ (18-22)	F = Efficiency factor: 1 - Percentage waiting in line
Average waiting time	$W = \frac{L + (T + U)}{N - L} = \frac{T(1 - F)}{XF}$ (18-23)	H = Average number of customers being served
Average number running	$J = NF(1 - X)$ (18-24)	J = Average number of customers not in line or in service
Average number being served	$H = FNX$ (18-25)	L = Average number of customers waiting for service
Number in population	$N = J + L + H$ (18-25)	M = Number of service channels N = Number of potential customers T = Average service time U = Average time between customer service requirements per customer W = Average time customers wait in line X = Service factor

$$F = \frac{J + H}{J + L + H}$$

*The purpose of this formula is to provide an understanding of F . Because the value of F is needed to compute J , L , and H , the formulas cannot be used to actually compute F . The finite queuing tables must be used for that purpose.

*Adapted from L. G. Peck and R. N. Hazelwood, *Finite Queuing Tables* (New York: John Wiley & Sons, 1958).

As in the infinite-source models, arrival rates are required to be Poisson and service times exponential. A major difference between the finite- and infinite-source models is that the arrival rate of customers in a finite situation is *affected by* the length of the waiting line; the arrival rate decreases as the length of the line increases simply because there is a decreasing proportion of the population left to generate calls for service. The limit occurs when *all* of the population is waiting in line. At that point, the arrival rate is zero because no additional units can arrive.

Because the mathematics of the finite-source model can be complex, analysts often use finite-queuing tables in conjunction with simple formulas to analyze these systems. Table 18.6 contains a list of the key formulas and definitions. You will find it helpful to study the diagram of a cycle that is presented in the table. It can be useful to think of the cycle in terms of a machine that is running (first part of the cycle), waiting to be repaired or unloaded (second phase of the cycle), or being repaired or unloaded (last phase of the cycle). The cycle then repeats.

Table 18.7 is an abbreviated finite-queuing table used to obtain values of D and F . (Most of the formulas require a value for F .) In order to use the finite-queuing table, follow this procedure:

1. Identify the values for
 - a. N , population size
 - b. M , number of servers/channels
 - c. T , average service time
 - d. U , average time between calls for service per customer
2. Compute the service factor, $X = T/(T + U)$.
3. Locate the section of the finite-queuing tables for N .

TABLE 18.7
Finite-queuing tables

<i>X</i>	<i>M</i>	<i>D</i>	<i>F</i>	<i>X</i>	<i>M</i>	<i>D</i>	<i>F</i>	<i>X</i>	<i>M</i>	<i>D</i>	<i>F</i>	<i>X</i>	<i>M</i>	<i>D</i>	<i>F</i>
Population 5				.125	2	.082	.994	.260	3	.058	.994	.440	3	.238	.960
.012	1	.060	.999		1	.575	.920		2	.303	.950		2	.652	.807
.019	1	.095	.998	.130	2	.089	.933		1	.903	.695		1	.992	.451
.025	1	.125	.997		1	.594	.914	.270	3	.064	.994	.460	4	.045	.995
.030	1	.149	.996	.135	2	.095	.933		2	.323	.944		3	.266	.953
.034	1	.169	.995		1	.612	.907		1	.915	.677		2	.686	.787
.036	1	.179	.994	.140	2	.102	.992	.280	3	.071	.993		1	.994	.432
.040	1	.199	.993		1	.630	.900		2	.342	.938	.480	4	.053	.994
.042	1	.208	.992	.145	3	.011	.999		1	.925	.661		3	.296	.945
.044	1	.218	.991		2	.109	.991	.290	4	.007	.999		2	.719	.767
.046	1	.228	.990		1	.647	.892		3	.079	.992		1	.996	.415
.050	1	.247	.989	.150	3	.012	.999		2	.362	.932	.500	4	.063	.992
.052	1	.257	.988		2	.115	.990		1	.934	.644		3	.327	.936
.054	1	.266	.987		1	.664	.885	.300	4	.008	.999		2	.750	.748
.056	2	.018	.999	.155	3	.013	.999		3	.086	.990		1	.997	.399
	1	.276	.985		2	.123	.989		2	.382	.926	.520	4	.073	.991
.058	2	.019	.999		1	.680	.877		1	.942	.628		3	.359	.927
	1	.285	.984	.160	3	.015	.999	.310	4	.009	.999		2	.779	.728
.060	2	.020	.999		2	.130	.988		3	.094	.989		1	.998	.384
	1	.295	.983		1	.695	.869		2	.402	.919	.540	4	.085	.989
.062	2	.022	.999	.165	3	.016	.999		1	.950	.613		3	.392	.917
	1	.304	.982		2	.137	.987	.320	4	.010	.999		2	.806	.708
.064	2	.023	.999		1	.710	.861		3	.103	.988		1	.998	.370
	1	.314	.981	.170	3	.017	.999		2	.422	.912	.560	4	.098	.986
.066	2	.024	.999		2	.145	.985		1	.956	.597		3	.426	.906
	1	.323	.979		1	.725	.853	.330	4	.012	.999		2	.831	.689
.068	2	.026	.999	.180	3	.021	.999		3	.112	.986		1	.999	.357
	1	.333	.978		2	.161	.983		2	.442	.904	.580	4	.113	.984
.070	2	.027	.999		1	.752	.836		1	.962	.583		3	.461	.895
	1	.342	.977	.190	3	.024	.998	.340	4	.013	.999		2	.854	.670
.075	2	.031	.999		2	.117	.980		3	.121	.985		1	.999	.345
	1	.365	.973		1	.778	.819		2	.462	.896	.600	4	.130	.981
.080	2	.035	.998	.200	3	.028	.998		1	.967	.569		3	.497	.883
	1	.388	.969		2	.194	.976	.360	4	.017	.998		2	.875	.652
.085	2	.040	.998		1	.801	.801		3	.141	.981		1	.999	.333
	1	.410	.965	.210	3	.032	.998		2	.501	.880	.650	4	.179	.972
.090	2	.044	.998		2	.211	.973		1	.975	.542		3	.588	.850
	1	.432	.960		1	.822	.783	.380	4	.021	.998		2	.918	.608
.095	2	.049	.997	.220	3	.036	.997		3	.163	.976		1	.999	.308
	1	.454	.955		2	.229	.969		2	.540	.863	.700	4	.240	.960
.100	2	.054	.997		1	.842	.765		1	.981	.516		3	.678	.815
	1	.475	.950	.230	3	.041	.997	.400	4	.026	.997		2	.950	.568
.105	2	.059	.997		2	.247	.965		3	.186	.972		1	.999	.286
	1	.496	.945		1	.860	.747		2	.579	.845	.750	4	.316	.944

(continued)

TABLE 18.7
(concluded)

<i>X</i>	<i>M</i>	<i>D</i>	<i>F</i>	<i>X</i>	<i>M</i>	<i>D</i>	<i>F</i>	<i>X</i>	<i>M</i>	<i>D</i>	<i>F</i>	<i>X</i>	<i>M</i>	<i>D</i>	<i>F</i>
.110	2	.065	.996	.240	3	.046	.996		1	.986	.493		3	.763	.777
	1	.516	.939		2	.265	.960	.420	4	.031	.997		2	.972	.532
.115	2	.017	.995		1	.876	.730		3	.211	.966	.800	4	.410	.924
	1	.537	.933	.250	3	.052	.995		2	.616	.826		3	.841	.739
.120	2	.076	.995		2	.284	.955		1	.989	.471		2	.987	.500
	1	.556	.927		1	.890	.712	.440	4	.037	.996				
.850	4	.522	.900	.064	1	.547	.940	.135	2	.415	.952	.220	5	.030	.998
	3	.907	.702	.066	2	.126	.995		1	.907	.699		4	.124	.990
	2	.995	.470		1	.562	.936	.140	4	.028	.999		3	.366	.954
.900	4	.656	.871	.068	3	.020	.999		3	.132	.991		2	.761	.815
	3	.957	.666		2	.133	.994		2	.437	.947		1	.993	.453
	2	.998	.444		1	.577	.931		1	.919	.680	.230	5	.037	.998
.950	4	.815	.838	.070	3	.022	.999	.145	4	.032	.999		4	.142	.988
	3	.989	.631		2	.140	.994		3	.144	.990		3	.400	.947
	Population 10				1	.591	.926		2	.460	.941		2	.791	.794
0.16	1	.144	.997	.075	3	.026	.999		1	.929	.662		1	.995	.434
.019	1	.170	.996		2	.158	.992	.150	4	.036	.998	.240	5	.044	.997
.021	1	.188	.995		1	.627	.913		3	.156	.989		4	.162	.986
.023	1	.206	.994	.080	3	.031	.999		2	.483	.935		3	.434	.938
.025	1	.224	.993		2	.177	.990		1	.939	.644		2	.819	.774
.026	1	.232	.992		1	.660	.899	.155	4	.040	.998		1	.996	.416
.028	1	.250	.991	.085	3	.037	.999		3	.169	.987	.250	6	.010	.999
.030	1	.268	.990		2	.196	.988		2	.505	.928		5	.052	.997
.032	2	.033	.999		1	.692	.883		1	.947	.627		4	.183	.983
	1	.285	.988	.090	3	.043	.998	.160	4	.044	.998		3	.469	.929
.034	2	.037	.999		2	.216	.986		3	.182	.986		2	.844	.753
	1	.301	.986		1	.722	.867		2	.528	.921		1	.997	.400
.036	2	.041	.999	.095	3	.049	.998		1	.954	.610	.260	6	.013	.999
	1	.320	.984		2	.237	.984	.165	4	.049	.997		5	.060	.996
.038	2	.046	.999		1	.750	.850		3	.195	.984		4	.205	.980
	1	.337	.982	.100	3	.056	.998		2	.550	.914		3	.503	.919
.040	2	.050	.999		2	.258	.981		1	.961	.594		2	.866	.732
	1	.354	.980		1	.776	.832	.170	4	.054	.997		1	.998	.384
.042	2	.055	.999	.105	3	.064	.997		3	.209	.982	.270	6	.015	.999
.044	2	.060	.998		1	.800	.814		1	.966	.579		4	.228	.976
.046	2	.065	.998		2	.301	.974		4	.066	.996		2	.886	.712
.048	2	.071	.998	.115	3	.081	.996		2	.614	.890	.280	6	.018	.999
	1	.421	.970		2	.324	.971		1	.975	.890		5	.081	.994
.050	2	.076	.998		1	.843	.776	.190	5	.016	.999		4	.252	.972
	1	.437	.967	.120	4	.016	.999		4	.078	.995		3	.571	.896
.052	2	.082	.997		3	.090	.995		3	.269	.973		2	.903	.692
	1	.454	.963		2	.346	.967		2	.654	.873		1	.999	.357
.054	2	.088	.997		1	.861	.756		1	.982	.522	.290	6	.022	.999
	1	.470	.960	.125	4	.019	.999	.200	5	.020	.999		5	.093	.993

(continued)

TABLE 18.7
(concluded)

X	M	D	F	X	M	D	F	X	M	D	F	X	M	D	F
.056	2	.094	.997		3	.100	.994		4	.092	.994		4	.278	.968
	1	.486	.956		2	.369	.962		3	.300	.968		3	.603	.884
.058	2	.100	.996		1	.878	.737		2	.692	.854		2	.918	.672
	1	.501	.953	.130	4	.022	.999		1	.987	.497		1	.999	.345
.060	2	.106	.996		3	.110	.994	.210	5	.025	.999	.300	6	.026	.998
	1	.517	.949		2	.392	.958		4	.108	.992		5	.106	.991
.062	2	.113	.996		1	.893	.718		3	.333	.961		4	.304	.963
	1	.532	.945	.135	4	.025	.999		2	.728	.835		3	.635	.872
.064	2	.119	.995		3	.121	.993		1	.990	.474				
.300	2	.932	.653	.400	6	.105	.991	.500	3	.972	.598	.650	7	.353	.954
	1	.999	.333		5	.292	.963		2	.999	.400		6	.651	.878
.310	6	.031	.998		4	.591	.887	.520	8	.026	.998		5	.882	.759
	5	.120	.990		3	.875	.728		7	.115	.989		4	.980	.614
	4	.331	.957		2	.991	.499		6	.316	.958		3	.999	.461
	3	.666	.858	.420	7	.034	.993		5	.606	.884	.700	9	.040	.997
	2	.943	.635		6	.130	.987		4	.864	.752		8	.200	.979
.320	6	.036	.998		5	.341	.954		3	.980	.575		7	.484	.929
	5	.135	.988		4	.646	.866		2	.999	.385		6	.772	.836
	4	.359	.952		3	.905	.700	.540	8	.034	.997		5	.940	.711
	3	.695	.845		2	.994	.476		7	.141	.986		4	.992	.571
	2	.952	.617	.440	7	.045	.997		6	.363	.949	.750	9	.075	.994
.330	6	.042	.997		6	.160	.984		5	.658	.867		8	.307	.965
	5	.151	.986		5	.392	.943		4	.893	.729		7	.626	.897
	4	.387	.945		4	.698	.845		3	.986	.555		6	.870	.792
	3	.723	.831		3	.928	.672	.560	8	.044	.996		5	.975	.666
	2	.961	.600		2	.996	.454		7	.171	.982		4	.998	.533
.340	7	.010	.999	.460	8	.011	.999		6	.413	.939	.800	9	.134	.988
	6	.049	.997		7	.058	.995		5	.707	.848		8	.446	.944
	5	.168	.983		6	.193	.979		4	.917	.706		7	.763	.859
	4	.416	.938		5	.445	.930		3	.991	.535		6	.939	.747
	3	.750	.816		4	.747	.822	.580	8	.057	.995		5	.991	.625
	2	.968	.584		3	.947	.646		7	.204	.977		4	.999	.500
.360	7	.014	.999		2	.998	.435		6	.465	.927	.850	9	.232	.979
	6	.064	.995	.480	8	.015	.999		5	.753	.829		8	.611	.916
	5	.205	.978		7	.074	.994		4	.937	.684		7	.879	.818
	4	.474	.923		6	.230	.973		3	.994	.517		6	.978	.705
	3	.798	.787		5	.499	.916	.600	9	.010	.999		5	.998	.588
	2	.978	.553		4	.791	.799		8	.072	.994	.900	9	.387	.963
.380	7	.019	.999		3	.961	.621		7	.242	.972		8	.785	.881
	6	.083	.993		2	.998	.417		6	.518	.915		7	.957	.777
	5	.247	.971	.500	8	.020	.999		5	.795	.809		6	.995	.667
	4	.533	.906		7	.093	.992		4	.953	.663	.950	9	.630	.938
	3	.840	.758		6	.271	.966		3	.996	.500		8	.934	.841
	2	.986	.525		5	.553	.901	.650	9	.021	.999		7	.994	.737
.400	7	.026	.998		4	.830	.775		8	.123	.988				

Source: L. G. Peck and R. N. Hazelwood, *Finite Queuing Tables* (New York: John Wiley & Sons, 1958).

4. Using the value of X as the point of entry, find the values of D and F that correspond to M .
5. Use the values of N , M , X , D , and F as needed to determine the values of the desired measures of system performance.

EXAMPLE 10

Finding Values of System Metrics for a Finite Source System



One operator loads and unloads a group of five machines. Service time is exponentially distributed, with a mean of 10 minutes per cycle. Machines run for an average of 70 minutes between loading and unloading, and this time is also exponential. Find the following:

- a. The average number of machines waiting for the operator
- b. The expected number of machines running
- c. Average downtime
- d. The probability that a machine will not have to wait for service

SOLUTION



$$N = 5$$

$$T = 10 \text{ minutes}$$

$$M = 1$$

$$U = 70 \text{ minutes}$$

$$X = \frac{T}{T + U} = \frac{10}{10 + 70} = .125$$

From Table 18.7, with $N = 5$, $M = 1$, and $X = .125$, $D = .575$ and $F = .920$.

- a. Average number waiting, $L = N(1 - F) = 5(1 - .920) = .40$ machine
- b. Expected number running, $J = NF(1 - X) = 5(.920)(1 - .125) = 4.025$ machines
- c. Downtime = Waiting time + Service time:

$$\text{Waiting time, } W = \frac{L(T + U)}{N - L} = \frac{.40(10 + 70)}{5 - .40} = 6.957 \text{ minutes}$$

$$\text{Downtime} = 6.957 \text{ minutes} + 10 \text{ minutes} = 16.957 \text{ minutes}$$

- d. Probability of not waiting = $1 - \text{Probability of waiting}$
 $= 1 - D$
 $= 1 - .575 = .425$

Using the Excel template, the solution to Example 10 would appear as follows:

Finite Source Waiting Line Model					
<Back					
Population Size	N =	5	5		
Number of servers	M =	1	2		
Average service time	T =	10	10		
Average time between service calls	U =	70	70		
P(wait) - from table	D =	0.5750	0.0820		
Efficiency factor - from table	F =	0.9200	0.9940		
Service factor	χ =	0.125	0.125		
Average number waiting	L =	0.4000	0.0300		
Average waiting time	W =	6.9565	0.4829		
Average number running	J =	4.0250	4.3488		
Average number being serviced	H =	0.5750	0.6213		
Per Time Unit					
Service cost =		10	20		
Downtime cost =		16	15.6	10.42	
Total Cost =			25.6	30.42	
Note: You must enter D and F (based on N, χ , and M) from the table in the text.					

Determining the Optimal Number of Servers to Minimize Total Cost**EXAMPLE 11**

Suppose that in Example 10 operators are paid \$10 per hour, and machine downtime costs \$16 per hour. Should the department add another operator if the goal is cost optimization?

Compare the total cost of the present system with the expected total cost of the proposed system:

SOLUTION

M	Average Number Down, $N - J$	Average Down Cost (per hour), $(N - J)\$16$	Operator Cost (per hour)	Total Cost (per hour)
1	.975	\$15.60	\$10	\$25.60
2	.651	10.42	20	30.42

Hence, the present system is superior because its total cost is less than the expected total cost using two operators.

18.8 CONSTRAINT MANAGEMENT

Managers may be able to reduce waiting times by actively managing one or more system constraints. Typically, in the short term, the facility size and the number of servers are fixed resources. However, some other options might be considered:

Use temporary workers. Using temporary or part-time workers during busy periods may be possible. Trade-offs might involve training costs, quality issues, and perhaps slower service than would be provided by regular workers.

Shift demand. In situations where demand varies by time of day, or time of week, variable pricing strategies can be effective in smoothing demand more evenly on the system. Theaters use this option with lower prices to shift demand from busy times to slower times. Restaurants offer “early-bird specials” to accomplish this. Some retail businesses offer coupons that are valid only for certain (slow) days or times.

Standardize the service. We saw the effect of constant service on waiting lines compared to nonconstant service (the number and time in line were cut in half). The more the service can be standardized, the greater the impact on waiting lines.

Look for a bottleneck. One aspect of a process may be largely responsible for a slow service rate. Improving that aspect of the process might yield a disproportionate increase in the service rate. In this regard, employees often have insights that can be utilized.

18.9 THE PSYCHOLOGY OF WAITING

Despite management’s best efforts, in some instances it is not feasible to shorten waiting times. Nevertheless, steps can be taken in certain situations that make the situation more acceptable to those waiting in line, particularly when the waiting line consists of people. The importance of doing so should not be underestimated.

Studies have shown a difference—sometimes a remarkable difference—between the *actual time* customers spend waiting and their *perceived time*. Several factors can influence the differences. One is the reason for being in line (e.g., waiting for police or fire personnel, waiting at the emergency room, having other appointments or a plane or train to catch). Aside from those situations, where the level of anxiety can make even short waits seem long, in many instances management can reduce their customers’ perception of the waiting time.

LO18.5 What are some psychological approaches to managing waiting lines, and why might a manager want to use them?



Michael Gordon/Shutterstock

The Department of Motor Vehicles in Columbia, South Carolina, added greeters, placed television screens in waiting rooms, and installed computerized programs to cut wait times.

If those waiting in line have nothing else to occupy their thoughts, they often tend to focus on the fact that they are waiting in line and usually perceive the waiting time to be longer than the actual waiting time. Conversely, if something else occupies them while they wait, their perception of the waiting time is often less than their actual waiting time. Examples of distractions include in-flight snacks, meals or videos, and magazines and televisions in waiting rooms. Giving customers something to do while waiting, such as filling out forms, can make their wait seem productive. Of course, some customers provide their own distractions (e.g., they talk on their cell phones, text messages, or play games on their cell phones). Another factor can be the level of comfort available (e.g., standing versus sitting, waiting outside in the weather versus inside or under cover). Also, informing customers how long the wait will be can reduce anxiety. For example, call centers sometimes announce the expected waiting time before a service representative will be available, and restaurants usually are able to tell patrons how long they will wait to be seated.

The following reading offers insights for managers on waiting lines. Several of these approaches are employed at Disney theme parks, as illustrated in the second reading.

READING



DAVID H. MAISTER ON THE PSYCHOLOGY OF WAITING

David H. Maister's classic article on the psychology of waiting included these pearls of wisdom about waiting that can serve as a guide to system designers and to those operating a system in which waiting lines of people occur:

- Occupied time feels shorter than unoccupied time.
- People want to get started.
- Anxiety makes waits seem longer.

- Uncertain waits are longer than known, finite waits.
- Unexplained waits are longer than explained waits.
- Unfair waits are longer than equitable waits.
- The more valuable the service, the longer the customer will wait.
- Solo waits feel longer than group waits.

Source: David H. Maister, "The Psychology of Waiting Lines," davidmaister.com, blog, September 8, 2008. Retrieved October 24, 2010.

The implication in these ideas is that imagination and creativity can often play an important role in system design and that mathematical approaches are not the only ones worth considering.

18.10 OPERATIONS STRATEGY

Managers must carefully assess the costs and benefits of various alternatives regarding the capacity of service systems. Working to increase the processing rate may be a worthwhile option, instead of increasing the number of servers. New processing equipment and/or processing methods may contribute to this goal. One important factor to consider is the possibility of reducing variability in processing times by increasing the degree of standardization of the service being provided. In fact, managers of all services would be wise to pursue this



Walt Disney theme parks are leaders in effectively managing waiting lines. Disney people present seminars on managing waiting lines. Their success can serve as a benchmark and provide valuable insights for a wide range of services.

Disney's methods are particularly relevant when circumstances make it impossible to quickly add capacity to alleviate waiting times. The following are some of the tactics Disney employs to achieve customer satisfaction:

1. **Provide distractions.** Disney characters may entertain customers, videos provide safety information and build anticipation for the event, vendors move along some lines selling food and drinks, and other vendors sell souvenirs.
2. **Provide alternatives for those willing to pay a premium.** Disney offers its FastPass system, which is free, but which also allows customers to pay to reserve a time when they will be allowed to bypass the regular waiting line, sometimes using a separate entrance. This has the potential for increasing customer satisfaction by enabling customers to enjoy more events, as well as the potential to generate additional revenue as customers visit food concessions and souvenir shops. Another tactic is to sell passes that allow customers to enter the park earlier.
3. **Keep customers informed.** Signs are clearly posted that give approximate waiting times from that point, allowing the customers to make a decision on whether to join the line and setting expectations.
4. **Exceed expectations.** Waiting times are kept to less than estimated times, thereby exceeding customers' expectations. Also, the event should be worth the wait.
5. **Other tactics.** Disney maintains a comfortable waiting environment: Waiting lines are often inside, protected from weather conditions. Lines are kept moving, giving the impression of making progress. Attendants and signs direct customers to sections of the park that are less busy.

Source: Based in part on "Queuing Featuring Disney World," McGraw-Hill Video Series.

goal, not only for the benefits of reduced waiting times, but also because of the benefits of standardizing server training, and hence reducing those costs and times, and because of the potential for increased quality due to the decreased variety in service requirements.

Other approaches might involve efforts to shift some arrivals to "off-times" by using reservations systems, "early-bird" specials, senior discounts, or some of the approaches used by Disney to manage customer waiting.

It is also important to recognize that the models presented in this chapter involve assumptions about the probability distributions of arrivals and service that may not be completely satisfied in practice.

Analysis of waiting lines can be an important aspect of the design of service systems. Waiting lines have a tendency to form in such systems even when, in a macro sense, the system is underloaded. The arrival of customers at random times and variability of service times combine to create temporary overloads. When this happens, waiting lines appear. By the same token, at other times the servers are idle.

A major consideration in the analysis of queuing systems is whether the number of potential customers is limited (finite source) or whether entry to the system is unrestricted (infinite source). Five basic queuing models are described, four dealing with infinite-source populations and one dealing with finite-source populations. In general, the models assume that customer arrival rates can be described by a Poisson distribution and that service time can be described by a negative exponential distribution.

Choosing the Appropriate Model

Infinite-Source Model. Use when entry to the system is unrestricted (open to the public).

The *basic relationship formulas* can be used with any infinite-source model. There are formulas for system utilization, the average number or average time waiting for service, the average number being served, and the average number or time in the system. Refer to Figure 18.7 to help you connect with the appropriate formula. You may also find the following list of comments to be helpful.

Single-channel model: Use when there is *one* server, team, or crew. See Table 18.2 and Example 2.

Single-channel, constant service time. See Formula 18-9 and Example 3.

Multiple-channel model. Use when there are *two or more* independent servers, teams, or crews. See Table 18.3 and Examples 4 and 5.

Multiple-priority model. Use when service order is based on priority class. See Table 18.5 and Example 8.

SUMMARY

Finite-Source Model. Use when entry to the system is restricted to system members. See Table 18.6 and Example 10.

KEY POINTS

1. Waiting lines occur because demand exceeds capacity in service systems.
2. The primary cause of waiting lines is variability in service times and/or customer arrival times.
3. Two important approaches to managing waiting lines are reducing variability where possible by standardizing a process and/or altering the perceived waiting time.

KEY TERMS

channel, 789 infinite-source situation, 789 queue discipline, 792
 finite-source situation, 789 multiple-priority model, 804 queuing theory, 786

SOLVED PROBLEMS

Use this approach for infinite-source problems:

1. Note the number of servers. If there is only one server, $M = 1$. Use the basic relationship formulas in Figure 18.7 and the single-server formulas in Table 18.2. If service is constant, use Formula 18–9 for L_q . For $M > 1$, use the basic relationship formulas in Figure 18.7, the multiple-server values in Table 18.4 for L_q and P_0 , and Formulas 18–12 and 18–13.
2. Determine the customer arrival rate and the service rate. If the arrival or service *time* is given instead of a rate, convert the time to a rate. For example, a service time of 10 minutes would convert to a service rate, μ , of $\mu = [1/(10 \text{ minutes/customer})] (60 \text{ minutes/hour}) = 6 \text{ customers/hour}$.
3. If multiple priorities are involved, use the Excel template on the website (preferred approach) or the formulas in Table 18.5.

Problem 1 *Infinite source.* One of the features of a new machine shop will be a well-stocked tool crib. The manager of the shop must decide on the number of attendants needed to staff the crib. Attendants will receive \$20. Mechanics' time will be worth \$30 per hour. Based on previous experience, the manager estimates requests for parts will average 18 per hour with a service capacity of 20 requests per hour per attendant. How many attendants should be on duty if the manager is willing to assume that arrival and service rates will be Poisson-distributed? (Assume the number of mechanics is very large, so an infinite-source model is appropriate.)

Solution $\lambda = 18$ per hour
 $\mu = 20$ per hour

The solution requires a trial-and-error approach that reveals the total cost of feasible alternatives (i.e., a utilization less than 100 percent) and selection of the lowest-cost alternative. Note that the total-cost curve will always be U-shaped; increase the number of servers until the total cost shows an increase over the previous value. The optimum will be the number of servers that produced the previous total cost value. Thus,

Number of Servers, M	L_q^*	$L_q + \frac{\lambda}{\mu} = L_s$	\$20M Server Cost (per hour)	\$30 L_s Mechanic Cost (per hour)	Total Cost (per hour)
1	8.1	$8.1 + 0.9 = 9.0$	\$20	\$270.00	\$290
2	0.229	$0.229 + 0.9 = 1.129$	\$40	\$ 33.87	\$ 74 [†]
3	0.03	$0.03 + 0.9 = 0.93$	\$60	\$ 27.90	\$ 88 [†]

* L_q from Table 18.4, with $r = \lambda/\mu = 18/20 = .9$

[†]Rounded.

Hence, two servers will produce the lowest total cost.

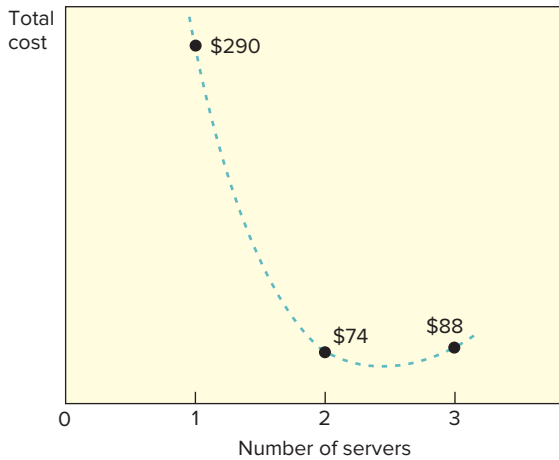

Infinite source. The following is a list of service times for three different operations.

Operation	Service Time
A	8 minutes
B	1.2 hours
C	2 days

- Determine the service rate for each operation.
- Would the calculated rates be different if these were interarrival times rather than service times?

a. The service rate is the reciprocal of service time. Thus, the rates are

A: $1/8$ customer per minute = .125 customer per minute, or $.125/\text{min} \times 60 \text{ min/hr} = 7.5$ customers per hour

B: $1/1.2$ customer per hour = .833 customer per hour

C: $1/2$ customer per day = .50 customer per day

b. No. In either case, the rate is simply the reciprocal of the time.

Problem 2

Solution

Finite source. A group of 10 machines is loaded and unloaded by one of three servers. The machines run for an average of six minutes per cycle, and average time to unload and reload is nine minutes. Each time can be described by an exponential distribution. While running, the machines produce at a rate that would yield 16 units per hour if they did not have to pause to wait for a server and be loaded and unloaded. What is the average hourly output of each machine when waiting and serving are taken into account?

$$T = 9 \text{ minutes}$$

$$U = 6 \text{ minutes}; x = \frac{T}{T + U} = \frac{9}{9 + 6} = .60$$

$$M = 3 \text{ servers; from Table 18.7, } F = .500$$

$$N = 10 \text{ machines}$$

a. Compute the average number of machines running:

$$J = NF(1 - X) = 10(.500)(.40) = 2$$

b. Determine the percentage of machines running, and multiply by output while running:

$$\frac{J}{N} \times (16 \text{ per hour}) = \frac{2}{10} \times (16 \text{ per hour}) = 3.2 \text{ units per hour per machine}$$

Problem 3

Solution

DISCUSSION AND REVIEW QUESTIONS

1. In what kinds of situations is queuing analysis most appropriate?
2. Why do waiting lines form even though a service system is underloaded?
3. What are the most common measures of system performance in a queuing analysis?
4. What effect would decreasing arrival and service variability have on the effective capacity of a system?
5. What approaches do supermarkets use to offset variations in customer traffic intensity?
6. Contrast *finite* and *infinite* population sources.
7. Under what circumstances would a multiple-priority waiting system be appropriate?
8. In a multiple-channel system, what is the rationale for having customers wait in a single line, as is now being done in many banks and post offices, rather than multiple lines? (*Hint*: The average waiting time is unaffected.)
9. What happens to the length of a waiting line in a highly variable (queuing) setting if a manager attempts to achieve a high percentage of capacity utilization?

TAKING STOCK

1. What general trade-offs are involved in waiting line decisions?
2. Who needs to be involved in assessing the cost of customers waiting for service if the customers are (a) the general public and (b) employees of the organization?
3. How has technology had an impact on analyzing waiting line systems? How has technology improved waiting line performance?

CRITICAL THINKING EXERCISES

1. What benefits do psychological approaches to waiting lines have over other approaches?
2. Consider this situation: A manager is contemplating making changes to a single-server system that is expected to double the service rate, and still have just one server.
 - a. Would you (intuitively) think that doubling the service rate of a single-server system would cut the average waiting time in line in half?
 - b. For the sake of analysis, suppose the current system has an arrival rate of 8 customers per hour and a service rate of 10 customers per hour. If the service rate is doubled, what impact will that have on the average number waiting in line?
 - c. What are some managerial implications of your analysis?
3. There are certain instances where pooling of operations can be desirable. For example, a large factory may have two or more locations where mechanics can obtain special tools or equipment they occasionally need. The separate locations mean less travel time for workers, but sometimes there will be a waiting line at one location while servers are idle at another location. What factors should an analysis of this sort of situation take into account in deciding on whether to keep separate locations or pool servers and equipment at one central location?
4. The owner of Eat Now Restaurant implemented an expanded menu early last year. The menu was a success, drawing many more customers who seemed to like the increased variety of menu choices over that of the previous menu. But good news soon became bad news as long waiting lines began to deter customers, and business dropped off. Because of space and other limitations, there didn't seem to be any viable options to consider. Then, a customer mentioned a technique called mass customization that was being used in the company he worked for. He said it really streamlined processing, and maybe it could work for the restaurant.

Describe how that approach might work at the restaurant and why that could be expected to reduce waiting times. What costs would be involved in transitioning to such a system? What other approaches could be used to reduce waiting times?
5. Describe two examples of unethical behavior related to waiting line management, and state which ethical principles they violate.

PROBLEMS

1. a. $\lambda = 3$ customers/hour
 $\mu = 5$ customers/hour
 $M = 1$
 - (1) What is the system utilization?
 - (2) What is the average number of customers waiting for service?
 - (3) What is the average time customers wait in line for service?

- b. Repair calls are handled by one repairman at a photocopy shop. Repair time, including travel time, is exponentially distributed, with a mean of two hours per call. Requests for copier repairs come in at a mean rate of three per eight-hour day (assume Poisson). Determine the following:
- (1) The average number of customers awaiting repairs
 - (2) System utilization
 - (3) The amount of time during an eight-hour day that the repairman is not out on a call
 - (4) The probability of two or more customers in the system
- c. An average of 18 customers arrive at a service center each hour. There are two servers on duty, and each server can process 12 customers per hour.
- (1) What is the system utilization?
 - (2) What is the average number of customers in the system (waiting plus being served)?
 - (3) What is the average time customers wait in line for service?
 - (4) What is the average waiting time for customers who actually have to wait?
2. A vending machine dispenses hot chocolate or coffee. Service time is 30 seconds per cup and is constant. Customers arrive at a mean rate of 80 per hour, and this rate is Poisson-distributed. Determine the following:
- a. The average number of customers waiting in line
 - b. The average time customers spend in the system
 - c. The average number in the system
3. Many of a bank's customers use its automatic teller machine to transact business after normal banking hours. During the early evening hours in the summer months, customers arrive at a certain location at the rate of one every other minute. This can be modeled using a Poisson distribution. Each customer spends an average of 90 seconds completing his or her transactions. Transaction time is exponentially distributed. Determine the following:
- a. The average time customers spend at the machine, including waiting in line and completing transactions
 - b. The probability that a customer will not have to wait upon arriving at the automatic teller machine
 - c. The average number waiting to use the machine
4. The following information pertains to telephone calls to a motel on a typical Tuesday.

Period	Incoming Rate (calls per minute)	Service Rate (calls per minute per operator)	Number of Operators
Morning	1.8	1.5	2
Afternoon	2.2	1.0	3
Evening	1.4	0.7	3

- a. Determine the average time callers wait to have their calls answered for each period and the probability that a caller will have to wait for each period.
 - b. For each case in the previous problem, determine the maximum line length for a probability of 96 percent.
5. A small town with one hospital has two ambulances to supply ambulance service. Requests for ambulances during non-holiday weekends average .45 per hour and tend to be Poisson-distributed. Travel and assistance time averages two hours per call and follows an exponential distribution. Find:
- a. System utilization
 - b. The average number of customers waiting
 - c. The average time customers wait for an ambulance
 - d. The probability that *both* ambulances will be busy when a call comes in
6. Trucks are required to pass through a weighing station so they can be checked for weight violations. Trucks arrive at the station at the rate of 40 an hour between 7:00 p.m. and 9:00 p.m. Currently two inspectors are on duty during those hours, each of whom can inspect 25 trucks an hour.
- a. How many trucks would you expect to see at the weighing station, including those being inspected?

- b. If a truck was just arriving at the station, about how many minutes could the driver expect to be at the station?
 - c. What is the probability that both inspectors would be busy at the same time?
 - d. How many minutes, on average, would a truck that is not immediately inspected have to wait?
 - e. What condition would exist if there was only one inspector?
 - f. What is the maximum line length for a probability of .97?
7. The manager of a regional warehouse must decide on the number of loading docks to request for a new facility in order to minimize the sum of dock costs and driver–truck costs. The manager has learned that each driver–truck combination represents a cost of \$300 per day and that each dock plus loading crew represents a cost of \$1,100 per day.
 - a. How many docks should be requested if trucks arrive at the rate of three per day, each dock can handle five trucks per day, and both rates are Poisson?
 - b. An employee has proposed adding new equipment that would speed up the loading rate to 6 trucks per day. The equipment would cost \$100 per day for each dock. Should the manager invest in the new equipment?
8. The parts department of a large automobile dealership has a counter used exclusively for mechanics' requests for parts. The time between requests can be modeled by a negative exponential distribution that has a mean of five minutes. A clerk can handle requests at a rate of 15 per hour, and this can be modeled by a Poisson distribution that has a mean of 15. Suppose there are two clerks at the counter.
 - a. On average, how many mechanics would be at the counter, including those being served?
 - b. What is the probability that a mechanic would have to wait for service?
 - c. If a mechanic has to wait, how long would the average wait be?
 - d. What percentage of time are the clerks idle?
 - e. If clerks represent a cost of \$20 per hour and mechanics a cost of \$30 per hour, what number of clerks would be optimal in terms of minimizing total cost?
9. One field representative services five customers for a computer manufacturer. Customers request assistance at an average (Poisson-distributed) rate of once every four working days. The field representative can handle an average (Poisson-distributed) of one call per day. Determine the following:
 - a. The expected number of customers waiting
 - b. The average length of time customers must wait from the initial request for service until the service has been completed
 - c. The percentage of time the service rep will be idle
 - d. How much your answer to part *a* would be reduced if a second field rep were added
10. Two operators handle adjustments for a group of 10 machines. Adjustment time is exponentially distributed and has a mean of 14 minutes per machine. The machines operate for an average of 86 minutes between adjustments. While running, each machine can turn out 50 pieces per hour. Find the following:
 - a. The probability that a machine will have to wait for an adjustment
 - b. The average number of machines waiting for adjustment
 - c. The average number of machines being serviced
 - d. The expected hourly output of each machine, taking adjustments into account
 - e. Machine downtime represents a cost of \$70 per hour; operator cost (including salary and fringe benefits) is \$15 per hour. What is the optimum number of operators?
11. One operator services a bank of five machines. Machine running time and service time are both exponential. Machines run for an average of 90 minutes between service requirements, and service time averages 35 minutes. The operator receives \$20 per hour in salary and fringe benefits, and machine downtime costs \$70 per hour per machine.
 - a. If each machine produces 60 pieces per hour while running, find the average hourly output of each machine, when waiting and service times are taken into account.
 - b. Determine the optimum number of operators.

12. A milling department has 10 machines. Each operates an average of eight hours before requiring adjustment, which takes an average of two hours. While running, each machine can produce 40 pieces an hour.
- With one adjuster, what is the net average hourly output per machine?
 - If machine downtime cost is \$80 per hour and adjuster cost is \$30 per hour, how many adjusters would be optimal?
13. Trucks arrive at the loading dock of a wholesale grocer at the rate of 1.2 per hour. A single crew consisting of two workers can load a truck in about 30 minutes. Crew members receive \$20 per hour in wages and fringe benefits, and trucks and drivers reflect an hourly cost of \$60. The manager is thinking of adding another member to the crew. The service rate would then be 2.4 trucks per hour. Assume rates are Poisson.
- Would the third crew member be economical?
 - Would a fourth member be justifiable if the resulting service capacity were 2.6 trucks per hour?
14. Customers arriving at a service center are assigned to one of three categories, with category 1 given the highest priority. Records indicate that an average of nine customers arrive per hour and that one-third are assigned to each category. There are two servers, and each can process customers at the rate of five per hour. Arrival and service rates can be described by Poisson distributions.
- What is the utilization rate for this system?
 - Determine the average waiting time for units in each class.
 - Find the average number of customers in each class that are waiting for service.
15. A manager must determine requirements for waiting space for customers. A priority system is used to process customers, who are assigned to one of two classes when they enter the processing center. The highest-priority class has an arrival rate of four per hour; the other class has an arrival rate of two per hour. Both can be described as Poisson-distributed. There are two servers, and each can process customers in 15 minutes, on average.
- What is the system utilization?
 - Determine the number of customers of each class that are waiting for service.
 - Determine the average waiting time for each class.
 - If the manager could alter the assignment rules so that arrival rates of the two classes were both 3/hour, what would be the revised average waiting time for each priority class?
16. A priority waiting system assigns arriving customers to one of four classes. Arrival rates (Poisson) of the classes are shown in the following table. Five servers process the customers, and each can handle three customers per hour.

Class	Arrivals per Hour
1	2
2	4
3	3
4	2

- What is the system utilization?
 - What is the average wait for service by customers in the various classes? How many are waiting in each class, on average?
 - If the arrival rate of the second priority class could be reduced to three units per hour by shifting some arrivals into the third priority class, how would your answers to part *b* change?
 - What observations can you make based on your answers to part *c*?
17. Referring to Problem 16, suppose that each server could handle four customers per hour. Answer the questions posed in the problem. Explain why the impact of reassigning customers is much less than in Problem 16.
18. During the morning hours at a catalog sales department, telephone calls come in at the rate (Poisson) of 40 per hour. Calls that cannot be answered immediately are put on hold. The system can handle eight callers on hold. If additional calls come in, they receive a busy signal. The three customer service representatives who answer the calls spend an average of three minutes with a customer.
- What is the probability that a caller will get a busy signal? (*Hint*: Solve for $\log K$ or $\ln K$ using trial and error.)
 - What is the probability that a customer will be put on hold?



The operations manager of a soon-to-open branch of a large bank is in the process of configuring teller operations. Currently, some branches have a separate teller line for customers who have a single transaction, while other branches don't have separate lines. The manager wants to avoid complaints about long waits that have been received at some branches. Because the demographics differ from location to location, a system that works at one branch won't necessarily work at another.

The manager has obtained data on processing times from the bank's home office and is ready to explore different options for configuring operations. (Fortunately, she has her textbook and CD from when she took an operations management course at a nearby university.)

An average of 80 customers are processed during the noon hour. The average processing time for customers with a single transaction is 90 seconds, while the processing time for customers

with multiple transactions is four minutes. Sixty percent of the customers are expected to have multiple transactions.

One time that will get special attention is the noon hour on Friday. The plan is to have five tellers available. Under consideration are the following options:

- Have one waiting line and have the first person in line go to the next available teller.
- Have two waiting lines: one teller for customers who have a single transaction and four tellers who would handle customers who have multiple transactions.

Questions

If you were the manager, which option would you select? Why? Explain the disparity between the results for the two options. What assumptions did you make in your analysis?

SELECTED BIBLIOGRAPHY AND FURTHER READINGS

Anderson, David R., Dennis J. Sweeney, Thomas A. Williams, Jeffrey D. Camm, and Skip Martin. *An Introduction to Management Science: Quantitative Approaches to Decision Making*, revised 13th ed. Mason, OH: South-Western, 2012.

Buffa, Elwood. *Operations Management*, 3rd ed. New York: John Wiley & Sons, 1972.

Griffin, W. *Queuing: Basic Theory and Applications*. Columbus, OH: Grid Publishing, 1978.

Hillier, Frederick S., and Mark S. Hillier. *Introduction to Management Science: A Modeling and*

Case Studies Approach with Spreadsheets, 5th ed. New York: McGraw-Hill, 2014.

Ragsdale, Cliff T. *Spreadsheet Modeling and Decision Analysis*, 6th ed. Mason, OH: South-Western, 2011.

Stevenson, William J., and Ceyhun Ozgur. *Introduction to Management Science with Spreadsheets*. New York: McGraw-Hill/Irwin, 2006.

Taylor, Bernard. *Introduction to Management Science*, 11th ed. Upper Saddle River, NJ: Pearson Prentice Hall, 2013.



19 Linear Programming

CHAPTER

LEARNING OBJECTIVES

After completing this chapter, you should be able to:

- LO19.1** Describe the type of problem that would lend itself to a solution using linear programming.
- LO19.2** Formulate a linear programming model from a description of a problem.
- LO19.3** Solve simple linear programming problems using the graphical method.
- LO19.4** Interpret computer solutions of linear programming problems.
- LO19.5** Do sensitivity analysis on the solution to a linear programming problem.

CHAPTER OUTLINE

- | | | |
|--|--|--|
| 19.1 Introduction 825 | Plotting the Objective Function Line 833 | 19.6 Sensitivity Analysis 843 |
| 19.2 Linear Programming Models 826 | Redundant Constraints 836 | Objective Function Coefficient Changes 843 |
| Model Formulation 827 | Solutions and Corner Points 837 | Changes in the Right-Hand-Side (RHS) Value of a Constraint 844 |
| 19.3 Graphical Linear Programming 828 | Minimization 837 | Cases: Son, Ltd. 853 |
| Outline of Graphical Procedure 828 | Slack and Surplus 839 | Custom Cabinets, Inc. 854 |
| Plotting Constraints 830 | 19.4 The Simplex Method 840 | |
| Identifying the Feasible Solution Space 833 | 19.5 Computer Solutions 840 | |
| | Solving LP Models Using MS Excel 840 | |



Kupicco/Getty Images

Linear programming is a powerful quantitative tool used by operations managers and other managers to obtain optimal solutions to problems that involve restrictions or limitations, such as budgets and available materials, labor, and machine time. These problems are referred to as *constrained optimization* problems. There are numerous examples of linear programming applications to such problems, including:

- Establishing locations for emergency equipment and personnel that will minimize response time
- Determining optimal schedules at airlines for planes, pilots, and ground personnel
- Developing financial plans
- Determining optimal blends of animal feed mixes
- Determining optimal diet plans
- Identifying the best set of worker–job assignments
- Developing optimal production schedules
- Developing shipping plans that will minimize shipping costs
- Identifying the optimal mix of products in a factory
- Performing production and service planning

19.1 INTRODUCTION

Linear programming (LP) techniques consist of a sequence of steps that will lead to an optimal solution to linear-constrained problems, if an optimal solution exists. There are a number of different linear programming techniques; some are special-purpose (i.e., used to find solutions for

specific types of problems) and others are more general in scope. This chapter covers the two general-purpose solution techniques: graphical linear programming and computer solutions. Graphical linear programming provides a visual portrayal of many of the important concepts of linear programming. However, it is limited to problems with only two variables. In practice, computers are used to obtain solutions for problems, some of which involve a large number of variables.

19.2 LINEAR PROGRAMMING MODELS



LO19.1 Describe the type of problem that would lend itself to a solution using linear programming.

Objective function Mathematical statement of profit (or cost, etc.) for a given solution.

Decision variables Amounts of either inputs or outputs.

Constraints Limitations that restrict the available alternatives.

Feasible solution space The set of all feasible combinations of decision variables as defined by the constraints.

Parameters Numerical constants.

Linear programming models are mathematical representations of constrained optimization problems. These models have certain characteristics in common. Knowledge of these characteristics enables us to recognize problems that can be solved using linear programming. In addition, it also can help us formulate LP models. The characteristics can be grouped into two categories: components and assumptions. First, let's consider the components.

Four components provide the structure of a linear programming model:

1. Objective function
2. Decision variables
3. Constraints
4. Parameters

Linear programming algorithms require that a single goal or *objective*, such as the maximization of profits, be specified. The two general types of objectives are maximization and minimization. A maximization objective might involve profits, revenues, efficiency, or rate of return. Conversely, a minimization objective might involve cost, time, distance traveled, or scrap. The **objective function** is a mathematical expression that can be used to determine the total profit (or cost, etc., depending on the objective) for a given solution.

Decision variables represent choices available to the decision maker in terms of the amounts of either inputs or outputs. For example, some problems require choosing a combination of inputs to minimize total costs, while others require selecting a combination of outputs to maximize profits or revenues.

Constraints are limitations that restrict the alternatives available to decision makers. The three types of constraints are less than or equal to (\leq), greater than or equal to (\geq), and simply equal to ($=$). A \leq constraint implies an upper limit on the amount of some scarce resource (e.g., machine hours, labor hours, materials) available for use. A \geq constraint specifies a minimum that must be achieved in the final solution (e.g., must contain at least 10 percent real fruit juice, must get at least 30 MPG on the highway). The $=$ constraint is more restrictive in the sense that it specifies *exactly* what a decision variable should equal (e.g., make 200 units of product A). A linear programming model can consist of one or more constraints. The constraints of a given problem define the set of combinations of the decision variables that satisfy all constraints; this set is referred to as the **feasible solution space**. Linear programming algorithms are designed to search the feasible solution space for the combination of decision variables that will yield an optimum in terms of the objective function.

An LP model consists of a mathematical statement of the objective, as well as a mathematical statement of each constraint. These statements consist of symbols (e.g., x_1 , x_2) that represent the decision variables and numerical values, called **parameters**. The parameters are fixed values; the model is solved *given* those values.

Example 1 illustrates an LP model.

EXAMPLE 1

Linear Programming Models Explained

Here is an LP model of a situation that involves the production of three possible products, each of which will yield a certain profit per unit, and each requires a certain use of two resources that are in limited supply: labor and materials. The objective is to determine

how much of each product to make to achieve the greatest possible profit while satisfying all constraints.

$$\begin{array}{l} \text{Decision variables} \\ \text{Maximize} \end{array} \quad \begin{cases} x_1 = \text{Quantity of product 1 to produce} \\ x_2 = \text{Quantity of product 2 to produce} \\ x_3 = \text{Quantity of product 3 to produce} \end{cases}$$

$$5x_1 + 8x_2 + 4x_3 \text{ (profit)} \quad \text{(Objective function)}$$

Subject to

$$\begin{array}{ll} \text{Labor} & 2x_1 + 4x_2 + 8x_3 \leq 250 \text{ hours} \\ \text{Material} & 7x_1 + 6x_2 + 5x_3 \leq 100 \text{ pounds} \\ \text{Product 1} & x_1 \geq 10 \text{ units} \end{array} \quad \text{(Constraints)}$$

$$x_1, x_2, x_3 \geq 0 \quad \text{(Nonnegativity constraints)}$$

First, the model lists and defines the decision variables. These typically represent *quantities*. In this case, they are quantities of three different products that might be produced.

Next, the model states the objective function. It includes every decision variable in the model and the contribution (profit per unit) of each decision variable. Thus, product x_1 has a profit of \$5 per unit. The profit from product x_1 for a given solution will be 5 times the value of x_1 specified by the solution; the total profit from all products will be the sum of the individual product profits. Thus, if $x_1 = 10$, $x_2 = 0$, and $x_3 = 6$, the value of the objective function would be:

$$5(10) + 8(0) + 4(6) = 74$$

The objective function is followed by a list (in no particular order) of three constraints. Each constraint has a right-hand-side numerical value (e.g., the labor constraint has a right-hand-side value of 250) that indicates the amount of the constraint and a relation sign that indicates whether that amount is a maximum (\leq), a minimum (\geq), or an equality ($=$). The left-hand side of each constraint consists of the variables subject to that particular constraint and a coefficient for each variable that indicates how much of the right-hand-side quantity *one unit* of the decision variable represents. For instance, for the labor constraint, one unit of x_1 will require two hours of labor. The sum of the values on the left-hand side of each constraint represents the amount of that constraint used by a solution. $x_1 = 10$, $x_2 = 0$, and $x_3 = 6$, the amount of labor used would be:

$$2(10) + 4(0) + 8(6) = 68 \text{ hours}$$

Because this amount does not exceed the quantity on the right-hand side of the constraint, it is said to be *feasible*.

Note that the third constraint refers to only a single variable; x_1 must be at least 10 units. Its implied coefficient is 1, although that is not shown.

Finally, there are the nonnegativity constraints. These are listed on a single line; they reflect the condition that no decision variable is allowed to have a negative value.

In order for LP models to be used effectively, certain *assumptions* must be satisfied:

1. **Linearity:** The impact of decision variables is linear in constraints and the objective function.
2. **Divisibility:** Noninteger values of decision variables are acceptable.
3. **Certainty:** Values of parameters are known and constant.
4. **Nonnegativity:** Negative values of decision variables are unacceptable.

Model Formulation

An understanding of the components of linear programming models is necessary for model formulation. This helps provide organization to the process of assembling information about a problem into a model.

Naturally, it is important to obtain valid information on what constraints are appropriate, as well as on what values of the parameters are appropriate. If this is not done, the usefulness of

LO19.2 Formulate a linear programming model from a description of a problem.

the model will be questionable. Consequently, in some instances, considerable effort must be expended to obtain that information.

In formulating a model, use the format illustrated in Example 1. Begin by identifying the decision variables. Very often, decision variables are “the quantity of” something, such as $x_1 =$ the quantity of product 1. Generally, decision variables have profits, costs, times, or a similar measure of value associated with them. Knowing this can help you identify the decision variables in a problem.

Constraints are restrictions or requirements on one or more decision variables, and they refer to available amounts of resources such as labor, material, or machine time, or to minimal requirements, such as “Make at least 10 units of product 1.” It can be helpful to give a name to each constraint, such as “labor” or “material 1.” Let’s consider some of the different kinds of constraints you will encounter.

1. A constraint that refers to one or more decision variables. This is the most common kind of constraint. The constraints in Example 1 are of this type.

2. A constraint that specifies a ratio. For example, “The ratio of x_1 to x_2 must be at least 3 to 2.” To formulate this, begin by setting up the following ratio:

$$\frac{x_1}{x_2} \geq \frac{3}{2}$$

Then, cross multiply, obtaining

$$2x_1 \geq 3x_2$$

This is not yet in a suitable form because all variables in a constraint must be on the left-hand side of the inequality (or equality) sign, leaving only a constant on the right-hand side. To achieve this, we must subtract the variable amount that is on the right side from both sides. That yields

$$2x_1 - 3x_2 \geq 0$$

(Note that the direction of the inequality remains the same.)

3. A constraint that specifies a percentage for one or more variables relative to one or more other variables. For example, “ x_1 cannot be more than 20 percent of the mix.” Suppose the mix consists of variables x_1 , x_2 , and x_3 . In mathematical terms, this would be

$$x_1 \leq .20(x_1 + x_2 + x_3)$$

As always, all variables must appear on the left-hand side of the relationship. To accomplish that, we can expand the right-hand side, and then subtract the result from both sides. Expanding yields

$$x_1 \leq .20x_1 + .20x_2 + .20x_3$$

Subtracting yields

$$.80x_1 - .20x_2 - .20x_3 \leq 0$$

Once you have formulated a model, the next task is to solve it. The following sections describe two approaches to a problem solution: graphical solutions and computer solutions.

19.3 GRAPHICAL LINEAR PROGRAMMING

LO19.3 Solve simple linear programming problems using the graphical method.

Graphical linear programming is a method for finding optimal solutions to two-variable problems. This section describes that approach.

Outline of Graphical Procedure

The graphical method of linear programming involves plotting the constraint lines on a graph and identifying an area on the graph that satisfies all of the constraints. The area is referred to as the *feasible solution space*. Next, the objective function is plotted and used to identify the optimal point in the feasible solution space. The coordinates of the point can sometimes be

Graphical linear programming
Graphical method for finding optimal solutions to two-variable problems.

read directly from the graph, although generally an algebraic determination of the coordinates of the point is necessary.

The general procedure followed in the graphical approach is as follows:

1. Set up the objective function and the constraints in mathematical format.
2. Plot the constraints.
3. Identify the feasible solution space.
4. Plot the objective function.
5. Determine the optimum solution.

The technique can best be illustrated through solution of a typical problem. Consider the problem described in Example 2.

Graphing the Problem and Finding the Optimal Solution

EXAMPLE 2

General description: A firm that assembles computers and computer equipment is about to start production of two new types of microcomputers. Each type will require assembly time, inspection time, and storage space. The amounts of each of these resources that can be devoted to the production of the microcomputers is limited. The manager of the firm would like to determine the quantity of each microcomputer to produce in order to maximize the profit generated by sales of these microcomputers.

Additional information: In order to develop a suitable model of the problem, the manager has met with design and production personnel. As a result of those meetings, the manager has obtained the following information.

	Type 1	Type 2
Profit per unit	\$60	\$50
Assembly time per unit	4 hours	10 hours
Inspection time per unit	2 hours	1 hour
Storage space per unit	3 cubic feet	3 cubic feet

The manager also has acquired information on the availability of company resources. These (daily) amounts are as follows.

Resource	Amount Available
Assembly time	100 hours
Inspection time	22 hours
Storage space	39 cubic feet

The manager met with the firm's marketing manager and learned that demand for the microcomputers was such that whatever combination of these two types of microcomputers is produced, all of the output can be sold.

In terms of meeting the assumptions, it would appear that the relationships are *linear*: The contribution to profit per unit of each type of computer and the time and storage space per unit of each type of computer are the same regardless of the quantity produced. Therefore, the total impact of each type of computer on the profit and each constraint is a linear function of the quantity of that variable. There may be a question of *divisibility* because, presumably, only whole units of computers will be sold. However, because this is a recurring process (i.e., the computers will be produced daily; a noninteger solution such as 3.5 computers per day will result in 7 computers every other day), this does not seem to pose a problem. The question of *certainty* cannot be explored here; in practice, the manager could be questioned to determine if there are any other possible constraints and whether the values shown for assembly times, and so forth, are known with certainty. For the purposes of discussion, we will assume certainty. Last, the assumption of *nonnegativity* seems justified; negative values for production quantities would not make sense.

Because we have concluded that linear programming is appropriate, let us now turn our attention to constructing a model of the microcomputer problem. First, we must define the decision variables. Based on the statement “The manager . . . would like to determine the quantity of each microcomputer to produce,” the decision variables are the quantities of each type of computer. Thus,

x_1 = quantity of type 1 to produce

x_2 = quantity of type 2 to produce

Next, we can formulate the objective function. The profit per unit of type 1 is listed as \$60, and the profit per unit of type 2 is listed as \$50, so the appropriate objective function is

$$\text{Maximize } Z = 60x_1 + 50x_2$$

where Z is the value of the objective function, given values of x_1 and x_2 . Theoretically, a mathematical function requires such a variable for completeness. However, in practice, the objective function often is written without the Z as sort of a shorthand version. (That approach is underscored by the fact that computer input does not call for Z : It is understood. The output of a computerized model does include a Z , though.)

Now for the constraints. There are three resources with limited availability: assembly time, inspection time, and storage space. The fact that availability is limited means that these constraints will all be \leq constraints. Suppose we begin with the assembly constraint. The type 1 microcomputer requires 4 hours of assembly time per unit, whereas the type 2 microcomputer requires 10 hours of assembly time per unit. Therefore, with a limit of 100 hours available, the assembly constraint is

$$4x_1 + 10x_2 \leq 100 \text{ hours}$$

Similarly, each unit of type 1 requires 2 hours of inspection time, and each unit of type 2 requires 1 hour of inspection time. With 22 hours available, the inspection constraint is

$$2x_1 + 1x_2 \leq 22$$

(*Note:* The coefficient of 1 for x_2 need not be shown. Thus, an alternative form for this constraint is $2x_1 + x_2 \leq 22$.) The storage constraint is determined in a similar manner:

$$3x_1 + 3x_2 \leq 39$$

There are no other system or individual constraints. The nonnegativity constraints are

$$x_1, x_2 \geq 0$$

In summary, the mathematical model of the microcomputer problem is

x_1 = quantity of type 1 to produce

x_2 = quantity of type 2 to produce

$$\text{Maximize } 60x_1 + 50x_2$$

Subject to

$$\text{Assembly} \quad 4x_1 + 10x_2 \leq 100 \text{ hours}$$

$$\text{Inspection} \quad 2x_1 + 1x_2 \leq 22 \text{ hours}$$

$$\text{Storage} \quad 3x_1 + 3x_2 \leq 39 \text{ cubic feet}$$

$$x_1, x_2 \geq 0$$

The next step is to plot the constraints.

Plotting Constraints

Begin by placing the nonnegativity constraints on a graph, as in Figure 19.1. The procedure for plotting the other constraints is simple:

1. Replace the inequality sign with an equal sign. This transforms the constraint into an *equation of a straight line*.

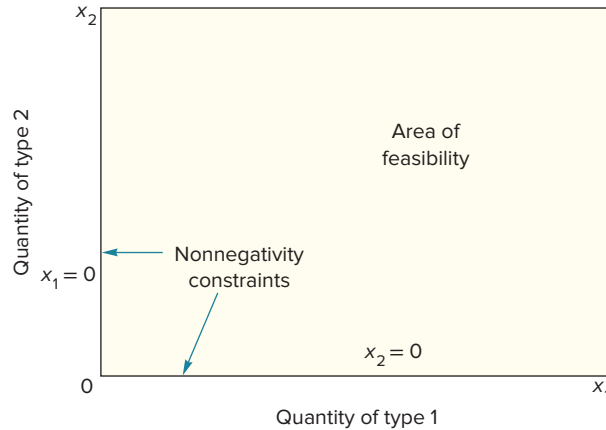
**FIGURE 19.1**

Graph showing the nonnegativity constraints

2. Determine where the line intersects each axis.
 - a. To find where it crosses the x_2 axis, set x_1 equal to zero and solve the equation for the value of x_2 .
 - b. To find where it crosses the x_1 axis, set x_2 equal to zero and solve the equation for the value of x_1 .
3. Mark these intersections on the axes, and connect them with a straight line. (*Note:* If a constraint has only one variable, it will be a vertical line on a graph if the variable is x_1 , or a horizontal line if the variable is x_2 .)
4. Indicate by shading (or by arrows at the ends of the constraint line) whether the inequality is greater than or less than. (A general rule to determine which side of the line satisfies the inequality is to pick a point that is not on line, such as 0,0; solve the equation using these values; and see whether it is greater than or less than the constraint amount.)
5. Repeat steps 1–4 for each constraint.

Consider the assembly time constraint:

$$4x_1 + 10x_2 \leq 100$$

Removing the inequality portion of the constraint produces this straight line:

$$4x_1 + 10x_2 = 100$$

Next, identify the points where the line intersects each axis, as step 2 describes. Thus with $x_2 = 0$, we find

$$4x_1 + 10(0) = 100$$

Solving, we find that $4x_1 = 100$, so $x_1 = 25$ when $x_2 = 0$. Similarly, we can solve the equation for x_2 when $x_1 = 0$:

$$4(0) + 10x_2 = 100$$

Solving for x_2 , we find $x_2 = 10$ when $x_1 = 0$.

Thus, we have two points: $x_1 = 0, x_2 = 10$, and $x_1 = 25, x_2 = 0$. We can now add this line to our graph of the nonnegativity constraints by connecting these two points (see Figure 19.2).

Next, we must determine which side of the line represents points that are less than 100. To do this, we can select a test point that is not on the line, and we can substitute the x_1 and x_2 values of that point into the left-hand side of the equation of the line. If the result is less than 100, this tells us that all points on that side of the line are less than the value of the line (e.g., 100). Conversely, if the result is greater than 100, this indicates that the other side of the line represents the set of points that will yield values that are less than 100. A relatively simple test point to use is the origin (i.e., $x_1 = 0, x_2 = 0$). Substituting these values into the equation yields a value of zero. Obviously, this is less than 100. Hence, the side of the line closest to the origin represents the “less than” area (i.e., the feasible region).

$$4(0) + 10(0) = 0$$

FIGURE 19.2 Plot of the first constraint (assembly time)

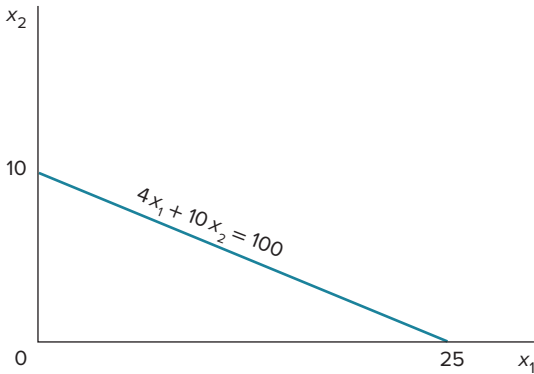
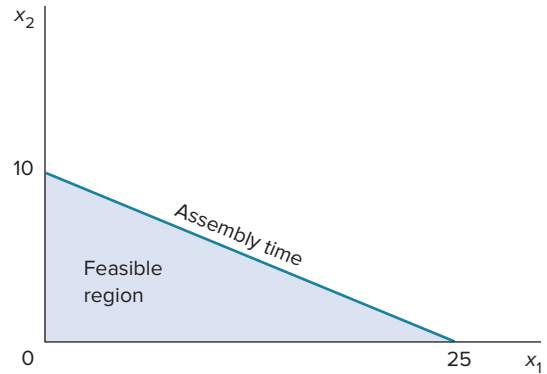

FIGURE 19.3 The feasible region, given the first constraint and the nonnegativity constraints



The feasible region for this constraint and the nonnegativity constraints then becomes the shaded portion shown in Figure 19.3.

For the sake of illustration, suppose we try one other point, say $x_1 = 10$, $x_2 = 10$. Substituting these values into the assembly constraint yields

$$4(10) + 10(10) = 140$$

Clearly, this is greater than 100. Therefore, all points on this side of the line are greater than 100 (see Figure 19.4).

Continuing with the problem, we can add the two remaining constraints to the graph. For the inspection constraint:

1. Convert the constraint into the equation of a straight line by replacing the inequality sign with an equality sign:

$$2x_1 + 1x_2 \leq 22 \quad \text{becomes} \quad 2x_1 + 1x_2 = 22$$

2. Set x_1 equal to zero and solve for x_2 :

$$2(0) + 1x_2 = 22$$

Solving, we find $x_2 = 22$. Thus, the line will intersect the x_2 axis at 22.

3. Next, set x_2 equal to zero and solve for x_1 :

$$2x_1 + 1(0) = 22$$

Solving, we find $x_1 = 11$. Thus, the other end of the line will intersect the x_1 axis at 11.

4. Add the line to the graph (see Figure 19.5).

Note that the area of feasibility for this constraint is below the line (Figure 19.5). Again, the area of feasibility at this point is shaded in for illustration purposes. When graphing problems, it is more practical to refrain from shading in the feasible region until all constraint lines have been drawn. However, because constraints are plotted one at a time, using a small arrow at the end of each constraint to indicate the direction of feasibility can be helpful.

The storage constraint is handled in the same manner:

1. Convert it into an equality:

$$3x_1 + 3x_2 = 39$$

2. Set x_1 equal to zero and solve for x_2 :

$$3(0) + 3x_2 = 39$$

FIGURE 19.4 The point (10, 10) is above the constraint line.

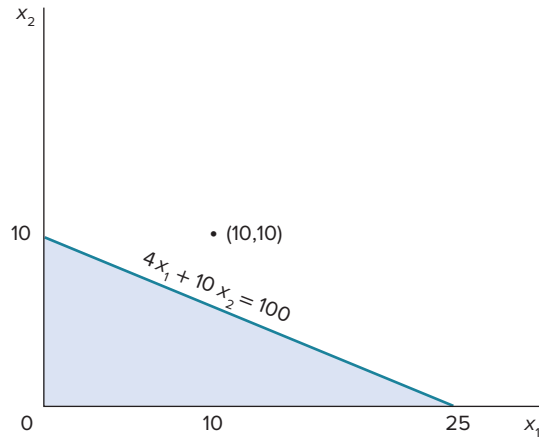
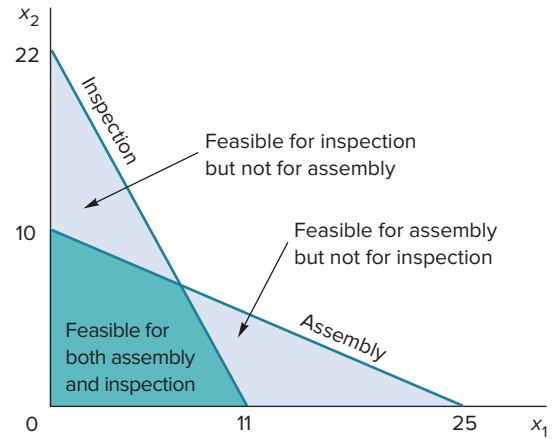

FIGURE 19.5 Partially completed graph, showing the assembly, inspection, and nonnegativity constraints



Solving, $x_2 = 13$. Thus, $x_2 = 13$ when $x_1 = 0$.

- Set x_2 equal to zero and solve for x_1 :

$$3x_1 + 3(0) = 39$$

Solving, $x_1 = 13$. Thus, $x_1 = 13$ when $x_2 = 0$.

- Add the line to the graph (see Figure 19.6).

Identifying the Feasible Solution Space

The feasible solution space is the set of all points that satisfies *all* constraints. (Recall that the x_1 and x_2 axes form nonnegativity constraints.) The heavily shaded area shown in Figure 19.6 is the feasible solution space for our problem.

The next step is to determine which point in the feasible solution space will produce the optimal value of the objective function. This determination is made using the objective function.

Plotting the Objective Function Line

Plotting an objective function line involves the same logic as plotting a constraint line: Determine where the line intersects each axis. Recall that the objective function for the microcomputer problem is

$$60x_1 + 50x_2$$

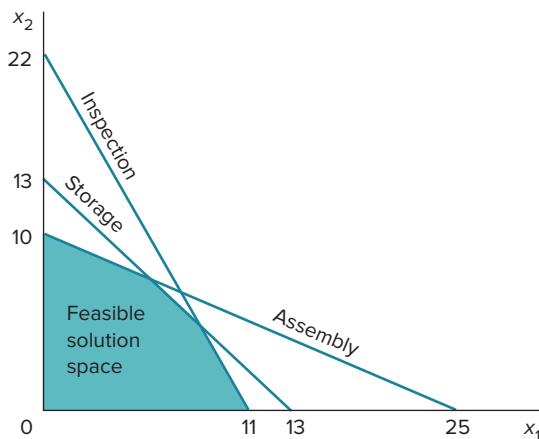

FIGURE 19.6

Completed graph of the microcomputer problem showing all constraints and the feasible solution space

This is not an equation because it does not include an equal sign. We can get around this by simply setting it equal to some quantity. Any quantity will do, although one that is evenly divisible by both coefficients is desirable.

Suppose we decide to set the objective function equal to 300. That is,

$$60x_1 + 50x_2 = 300$$

We can now plot the line on our graph. As before, we can determine the x_1 and x_2 intercepts of the line by setting one of the two variables equal to zero, solving for the other, and then reversing the process. Thus, with $x_1 = 0$, we have

$$60(0) + 50x_2 = 300$$

Solving, we find $x_2 = 6$. Similarly, with $x_2 = 0$, we have

$$60x_1 + 50(0) = 300$$

Solving, we find $x_1 = 5$. This line is plotted in Figure 19.7.

The profit line can be interpreted in the following way: It is an *isoprofit* line; every point on the line (i.e., every combination of x_1 and x_2 that lies on the line) will provide a profit of \$300. We can see from the graph many combinations that are both on the \$300 profit line and within the feasible solution space. In fact, considering noninteger as well as integer solutions, the possibilities are infinite.

Suppose we now consider another line, say the \$600 line. To do this, we set the objective function equal to this amount. Thus,

$$60x_1 + 50x_2 = 600$$

Solving for the x_1 and x_2 intercepts yields these two points:

x_1 intercept	x_2 intercept
$x_1 = 10$	$x_1 = 0$
$x_2 = 0$	$x_2 = 12$

This line is plotted in Figure 19.8, along with the previous \$300 line for purposes of comparison.

Two things are evident in Figure 19.8 regarding the profit lines. One is that the \$600 line is *farther* from the origin than the \$300 line; the other is that the two lines are *parallel*. The lines are parallel because they both have the same slope. The slope is not affected by the right side of the equation. Rather, it is determined solely by the coefficients 60 and 50. It would

FIGURE 19.7 Microcomputer problem with \$300 profit line added

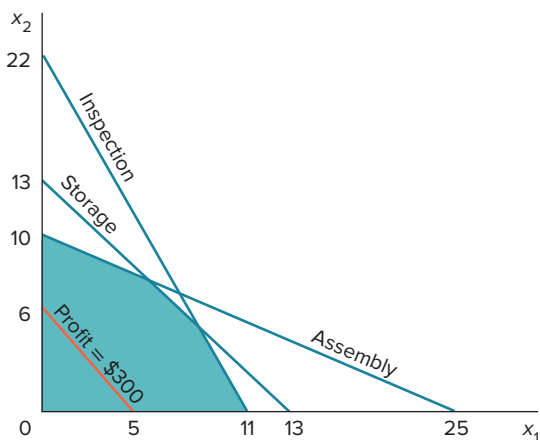
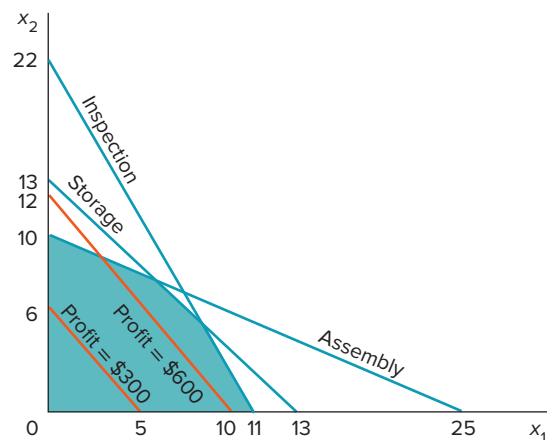

FIGURE 19.8 Microcomputer problem with profit lines of \$300 and \$600



be correct to conclude that regardless of the quantity we select for the value of the objective function, the resulting line will be parallel to these two lines. Moreover, if the amount is greater than 600, the line will be even farther away from the origin than the \$600 line. If the value is less than 300, the line will be closer to the origin than the \$300 line. And if the value is between 300 and 600, the line will fall between the \$300 and \$600 lines. This knowledge will help in determining the optimal solution.

Consider a third line, one with the profit equal to \$900. Figure 19.9 shows that line along with the previous two profit lines. As expected, it is parallel to the other two, and even farther away from the origin. However, the line does not touch the feasible solution space at all. Consequently, there is no feasible combination of x_1 and x_2 that will yield that amount of profit. Evidently, the maximum possible profit is an amount between \$600 and \$900, which we can see by referring to Figure 19.9. We could continue to select profit lines in this manner, and eventually could determine an amount that would yield the greatest profit. However, there is a much simpler alternative. We can plot just one line, say the \$300 line. We know that all other lines will be parallel to it. Consequently, by moving this one line parallel to itself, we can “test” other profit lines. We also know that as we move away from the origin, the profits get larger. What we want to know is how far the line can be moved out from the origin and still be touching the feasible solution space, and the values of the decision variables at that point of greatest profit (i.e., the optimal solution). Locate this point on the graph by placing a straight edge along the \$300 line (or any other convenient line) and sliding it away from the origin, being careful to keep it parallel to the line. This approach is illustrated in Figure 19.10.

Once we have determined where the optimal solution is in the feasible solution space, we must determine the values of the decision variables at that point. Then, we can use that information to compute the profit for that combination.

Note that the optimal solution is at the intersection of the inspection boundary and the storage boundary, which is one of the corner points (see Figure 19.10). In other words, the optimal combination of x_1 and x_2 must satisfy both boundary (equality) conditions. We can determine those values by solving the two equations *simultaneously*. The equations are:

$$\text{Inspection} \quad 2x_1 + 1x_2 = 22$$

$$\text{Storage} \quad 3x_1 + 3x_2 = 39$$

The idea behind solving two *simultaneous equations* is to algebraically eliminate one of the unknown variables (i.e., to obtain an equation with a single unknown). This can be accomplished by multiplying the constants of one of the equations by a fixed amount and then adding (or subtracting) the modified equation from the other. (Occasionally, it is easier to multiply each equation by a fixed quantity.) For example, we can eliminate x_2 by multiplying

FIGURE 19.9 Microcomputer problem with profit lines of \$300, \$600, and \$900

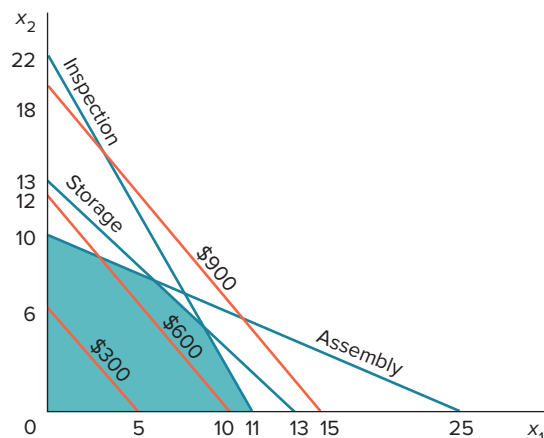
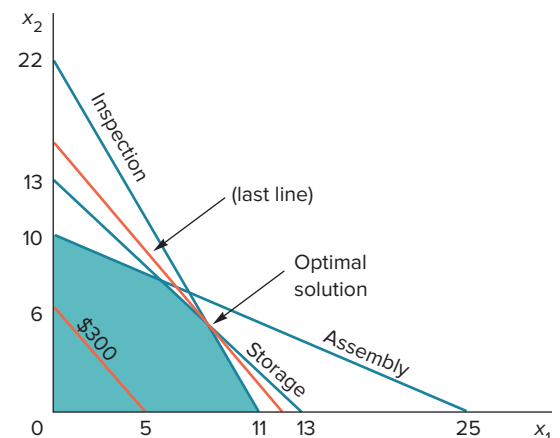

FIGURE 19.10 Finding the optimal solution to the microcomputer problem



the inspection equation by 3 and then subtracting the storage equation from the modified inspection equation. Thus,

$$3(2x_1 + 1x_2 = 22) \text{ becomes } 6x_1 + 3x_2 = 66$$

Subtracting the storage equation from this produces

$$\begin{array}{r} 6x_1 + 3x_2 = 66 \\ -(3x_1 + 3x_2 = 39) \\ \hline 3x_1 + 0x_2 = 27 \end{array}$$

Solving the resulting equation yields $x_1 = 9$. The value of x_2 can be found by substituting $x_1 = 9$ into either of the original equations or the modified inspection equation. Suppose we use the original inspection equation. We have

$$2(9) + 1x_2 = 22$$

Solving, we find $x_2 = 4$.

Hence, the optimal solution to the microcomputer problem is to produce nine type 1 computers and four type 2 computers per day. We can substitute these values into the objective function to find the optimal profit:

$$\$60(9) + \$50(4) = \$740$$

Hence, the last line—the one that would last touch the feasible solution space as we moved away from the origin parallel to the \$300 profit line—would be the line where profit equaled \$740.

In this problem, the optimal values for both decision variables are integers. This will not always be the case; one or both of the decision variables may turn out to be noninteger. In some situations, noninteger values would be of little consequence. This would be true if the decision variables were measured on a continuous scale, such as the amount of water, sand, sugar, fuel oil, time, or distance needed for optimality, or if the contribution per unit (profit, cost, etc.) were small, as with the number of nails or ball bearings to make. In some cases, the answer would simply be rounded down (maximization problems) or up (minimization problems) with very little impact on the objective function. Here, we assume that noninteger answers are acceptable as such.

Let's review the procedure for finding the optimal solution using the objective function approach:

1. Graph the constraints.
2. Identify the feasible solution space.
3. Set the objective function equal to some amount that is divisible by each of the objective function coefficients. This will yield integer values for the x_1 and x_2 intercepts and simplify plotting the line. Often, the product of the two objective function coefficients provides a satisfactory line. Ideally, the line will cross the feasible solution space close to the optimal point, and it will not be necessary to slide a straight edge because the optimal solution can be readily identified visually.
4. After identifying the optimal point, determine which two constraints intersect there. Solve their equations simultaneously to obtain the values of the decision variables at the optimum.
5. Substitute the values obtained in the previous step into the objective function to determine the value of the objective function at the optimum.

Redundant Constraints

In some cases, a constraint does not form a unique boundary of the feasible solution space. Such a constraint is called a **redundant constraint**. Two such constraints are illustrated in Figure 19.11. Note that a constraint is redundant if it meets the following test: Its removal would not alter the feasible solution space.

Redundant constraint A constraint that does not form a unique boundary of the feasible solution space.

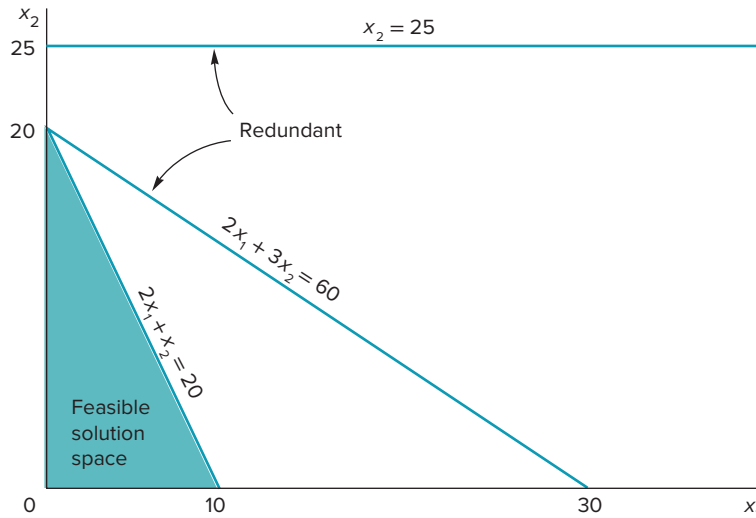

FIGURE 19.11
Examples of redundant constraints

When a problem has a redundant constraint, at least one of the other constraints in the problem is more restrictive than the redundant constraint.

Solutions and Corner Points

The feasible solution space in graphical linear programming is typically a polygon. Moreover, the solution to any problem will always be at a corner point (intersection of constraints) of the polygon. It is possible to determine the coordinates of each corner point of the feasible solution space, and use those values to compute the value of the objective function at those points. Because the solution is always at a corner point, comparing the values of the objective function at the corner points and identifying the best one (e.g., the maximum value) is another way to identify the optimal corner point. Using the graphical approach, it is much easier to plot the objective function and use that to identify the optimal corner point. However, for problems that have more than two decision variables, and the graphical method isn't appropriate, the "enumeration" approach is used to find the optimal solution.

With the **enumeration approach**, the coordinates of each corner point are determined, and then each set of coordinates is substituted into the objective function to determine its value at that corner point. After all corner points have been evaluated, the one with the maximum or minimum value (depending on whether the objective is to maximize or minimize) is identified as the optimal solution.

Thus, in the microcomputer problem, the corner points are $x_1 = 0, x_2 = 10$, $x_1 = 11, x_2 = 0$ (by inspection; see Figure 19.10), and $x_1 = 9, x_2 = 4$ and $x_1 = 5, x_2 = 8$ (using simultaneous equations, as illustrated on the previous pages). Substituting into the objective function, the values are \$500 for (0,10); \$740 for (9,4); \$660 for (11,0), and \$700 for (5,8). Because (9,4) yields the highest value, that corner point is the optimal solution.

In some instances, the objective function will be *parallel* to one of the constraint lines that forms a *boundary of the feasible solution space*. When this happens, *every* combination of x_1 and x_2 on the segment of the constraint that touches the feasible solution space represents an optimal solution. Hence, there are multiple optimal solutions to the problem. Even in such a case, the solution will also be a corner point—in fact, the solution will be at *two* corner points: those at the ends of the segment that touches the feasible solution space. Figure 19.12 illustrates an objective function line that is parallel to a constraint line.

Minimization

Graphical minimization problems are quite similar to maximization problems. There are, however, two important differences. One is that at least one of the constraints must be of the $=$ or \geq variety. This causes the feasible solution space to be away from the origin. The other difference is that the optimal point is the one closest to the origin. We find the optimal corner point by sliding the objective function (which is an *isocost* line) *toward* the origin instead of away from it.

Enumeration approach
Substituting the coordinates of each corner point into the objective function to determine which corner point is optimal.

FIGURE 19.12

Some LP problems have multiple optimal solutions.

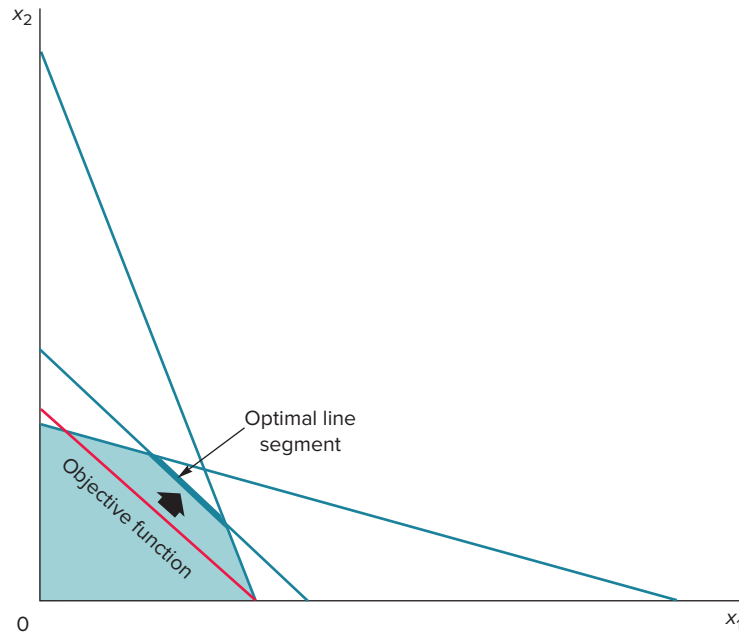
**EXAMPLE 3****Solving a Minimization Problem**

Solve the following problem using graphical linear programming.

$$\begin{aligned} \text{Minimize} \quad & Z = 8x_1 + 12x_2 \\ \text{Subject to} \quad & 5x_1 + 2x_2 \geq 20 \\ & 4x_1 + 3x_2 \geq 24 \\ & x_2 \geq 2 \\ & x_1, x_2 \geq 0 \end{aligned}$$

SOLUTION

- Plot the constraints (shown in Figure 19.13).
 - Change the constraints to equalities.
 - For each constraint, set $x_1 = 0$ and solve for x_2 , then set $x_2 = 0$ and solve for x_1 .
 - Graph each constraint. Note that $x_2 = 2$ is a horizontal line parallel to the x_1 axis and 2 units above it.
- Shade the feasible solution space (see Figure 19.13).
- Plot the objective function.
 - Select a value for the objective function that causes it to cross the feasible solution space. Try $8 \times 12 = 96$; $8x_1 + 12x_2 = 96$ (acceptable).
 - Graph the line (see Figure 19.14).
- Slide the objective function toward the origin, being careful to keep it parallel to the original line.
- The optimum (last feasible point) is shown in Figure 19.14. The x_2 coordinate ($x_2 = 2$) can be determined by inspection of the graph. Note that the optimum point is at the intersection of the line $x_2 = 2$ and the line $4x_1 + 3x_2 = 24$. Substituting the value of $x_2 = 2$ into the latter equation will yield the value of x_1 at the intersection:

$$4x_1 + 3(2) = 24 \quad x_1 = 4.5$$
 Thus, the optimum is $x_1 = 4.5$ units and $x_2 = 2$.
- Compute the minimum cost:

$$8x_1 + 12x_2 = 8(4.5) + 12(2) = 60$$

FIGURE 19.13 The constraints define the feasible solution space.

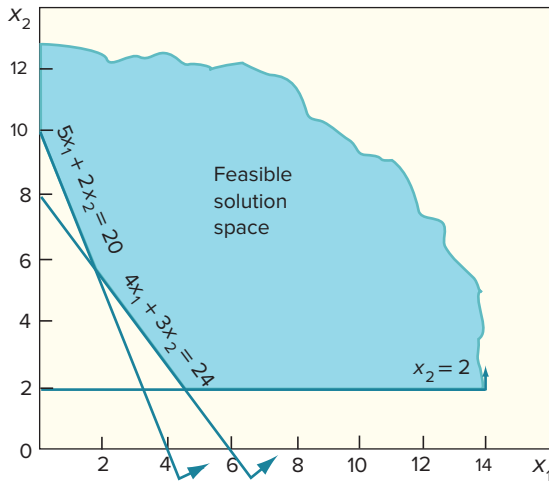
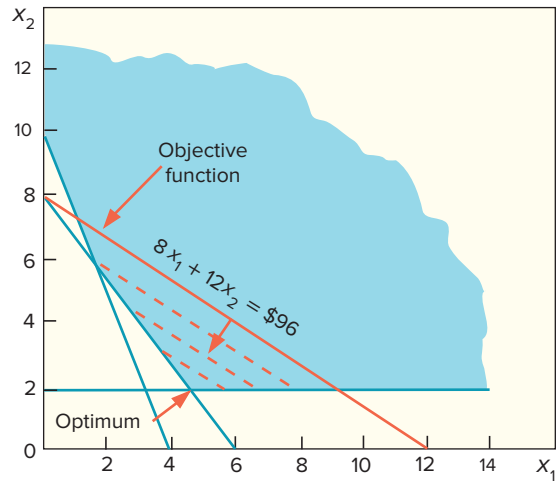

FIGURE 19.14 The optimum is the last point the objective function touches as it is moved toward the origin.



Slack and Surplus

If a constraint forms the optimal corner point of the feasible solution space, it is called a **binding constraint**. In effect, it limits the value of the objective function; if the constraint could be relaxed (less restrictive), an improved solution would be possible. For constraints that are not binding, making them less restrictive will have no impact on the solution.

If the optimal values of the decision variables are substituted into the left-hand side of a binding constraint, the resulting value will exactly equal the right-hand value of the constraint. However, there will be a difference with a nonbinding constraint. If the left-hand side is greater than the right-hand side, we say there is **surplus**; if the left-hand side is less than the right-hand side, we say there is **slack**. Slack can only occur in a \leq constraint; it is the amount by which the left-hand side is less than the right-hand side when the optimal values of the decision variables are substituted into the left-hand side. And surplus can only occur in a \geq constraint. It is the amount by which the left-hand side exceeds the right-hand side of the constraint when the optimal values of the decision variables are substituted into the left-hand side.

For example, suppose the optimal values for a problem are $x_1 = 10$ and $x_2 = 20$. If one of the constraints is

$$3x_1 + 2x_2 \leq 100$$

substituting the optimal values into the left-hand side yields

$$3(10) + 2(20) = 70$$

Because the constraint is \leq , the difference between the values of 100 and 70 (i.e., 30) is **slack**. Suppose the optimal values had been $x_1 = 20$ and $x_2 = 20$. Substituting these values into the left-hand side of the constraint would yield $3(20) + 2(20) = 100$. Because the left-hand side equals the right-hand side, this is a binding constraint; slack is equal to zero.

Now consider this constraint:

$$4x_1 + x_2 \geq 50$$

Suppose the optimal values are $x_1 = 10$ and $x_2 = 15$; substituting into the left-hand side yields

$$4(10) + 15 = 55$$

Because this is a \geq constraint, the difference between the left- and right-hand-side values is **surplus**. If the optimal values had been $x_1 = 12$ and $x_2 = 2$, substitution would result in the

Binding constraint A constraint that forms the optimal corner point of the feasible solution space.

Surplus When the values of decision variables are substituted into a \geq constraint, the amount by which the resulting value exceeds the right-hand-side value.

Slack When the values of decision variables are substituted into a \leq constraint, the amount by which the resulting value is less than the right-hand-side value.

left-hand side being equal to 50. Hence, the constraint would be a binding constraint, and there would be no surplus (i.e., surplus would be zero).

19.4 THE SIMPLEX METHOD

Simplex A linear programming algorithm that can solve problems having more than two decision variables.

The **Simplex** method is a general-purpose linear programming algorithm widely used to solve large-scale problems. Although it lacks the intuitive appeal of the graphical approach, its ability to handle problems with more than two decision variables makes it extremely valuable for solving problems often encountered in operations management.

Although manual solution of linear programming problems using simplex can yield a number of insights into how solutions are derived, space limitations preclude describing it here. However, it is available on the website that accompanies this book. The discussion here will focus on computer solutions.

19.5 COMPUTER SOLUTIONS

LO19.4 Interpret computer solutions of linear programming problems.

The microcomputer problem will be used to illustrate computer solutions. We repeat it here for ease of reference.

Maximize $60x_1 + 50x_2$ where x_1 = the number of type 1 computers
 x_2 = the number of type 2 computers

Subject to

Assembly	$4x_1 + 10x_2$	≤ 100 hours
Inspection	$2x_1 + 1x_2$	≤ 22 hours
Storage	$3x_1 + 3x_2$	≤ 39 cubic feet
	x_1, x_2	≥ 0

Solving LP Models Using MS Excel

Solutions to linear programming models can be obtained from spreadsheet software such as Microsoft's Excel. Excel has a routine called Solver that performs the necessary calculations.

To use Solver:

1. First, enter the problem in a worksheet, as shown in Figure 19.15. What is not obvious from the figure is the need to enter a formula for each cell where there is a zero (Solver automatically inserts the zero after you input the formula). The formulas are for the value of the objective function and the constraints, in the appropriate cells. Before you enter the formulas, designate the cells where you want the optimal values of x_1 and x_2 . Here, cells D4 and E4 are used. To enter a formula, click the cell that the formula will pertain to, and then enter the formula, starting with an equal sign. We want the optimal value of the objective function to appear in cell G4. For G4, enter the formula

$$= 60*D4 + 50*E4$$

The constraint formulas, using cells C7, C8, and C9, are

$$\text{for C7: } = 4*D4 + 10*E4$$

$$\text{for C8: } = 2*D4 + 1*E4$$

$$\text{for C9: } = 3*D4 + 3*E4$$

2. Now, to access Solver in Excel, click Data at the top of the worksheet, and in that ribbon, click Solver in the Analysis group. The Solver menu will appear as illustrated in Figure 19.16. If it does not appear there, it must be enabled using the Add-ins menu. Begin by setting the objective (i.e., indicating the cell where you want the optimal value of the objective function to appear). Note, if the activated cell is the cell designated for the value of Z when you click Solver, Solver will automatically set that cell as the Objective.

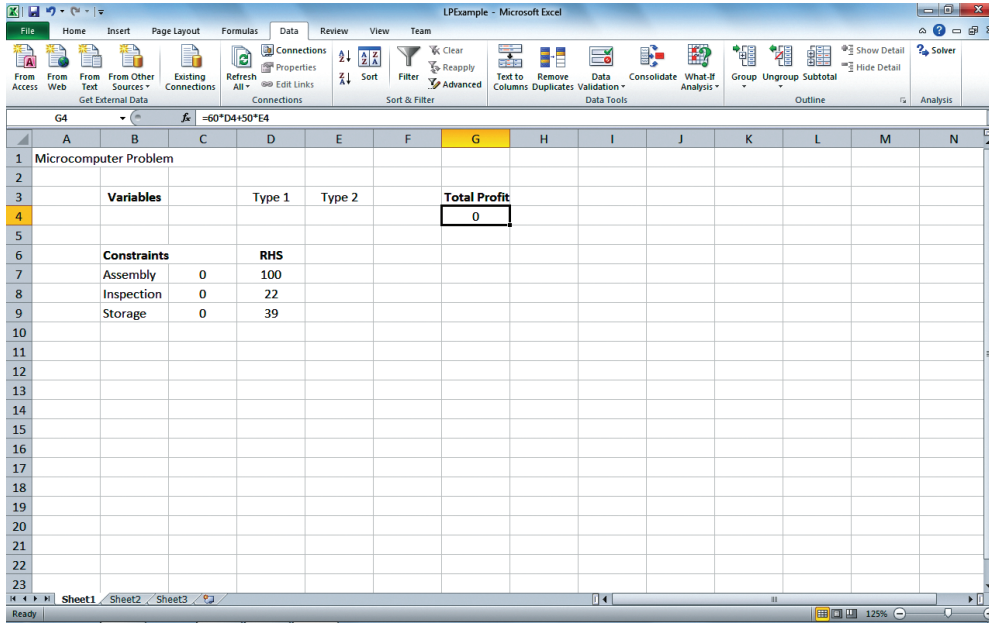

FIGURE 19.15
MS Excel worksheet for microcomputer problem

Source: Microsoft

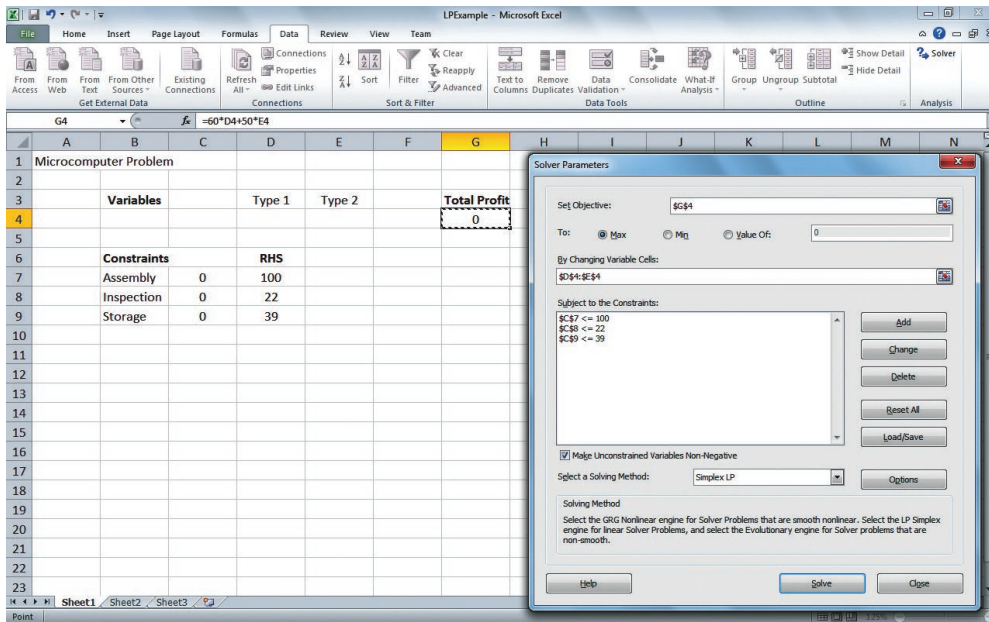

FIGURE 19.16
MS Excel Solver parameters for microcomputer problem

Source: Microsoft

Select the Max radio button if it isn't already selected. The Changing Variable Cells are the cells where you want the optimal values of the decision variables to appear. Here, they are cells D4 and E4. We indicate this by the range D4:E4 (Solver will add the \$ signs).

Finally, add the constraints by clicking Add. When that menu appears, for each constraint, enter the cell that contains the formula for the left-hand side of the constraint, then select the appropriate inequality sign, and then enter the right-hand-side amount of the cell that has the right-hand-side amount. Here the right-hand-side amounts are used. After you have entered each constraint, either click Add to add another constraint or click OK to return to the Solver menu. (*Note:* Constraints can be entered in any order, and if cells are used for the right-hand side, then constraints with the same inequality can be grouped.) For the nonnegativity constraints, simply check the checkbox to Make Unconstrained Variables Non-Negative. Also select Simplex LP as the Solving Method. Click Solve.

- The Solver Results menu will then appear, indicating a solution has been found, or an error has occurred. If an error occurs, return to the Solver Parameters menu and check to see that your constraints refer to the correct changing cells, and that the inequality directions are correct. Make the corrections and click Solve.

Assuming everything is correct, in the Solver Results menu, in the Reports box, highlight both Answer and Sensitivity, and then click OK.

- Solver will incorporate the optimal values of the decision variables and the objective function in your original layout on your worksheet (see Figure 19.17). We can see that the optimal values are type 1 = 9 units and type 2 = 4 units, and the total profit is 740. The answer report will also show the optimal values of the decision variables (middle part of Figure 19.18), and some information on the constraints (lower part of Figure 19.18). Of particular interest here is information on which constraints have slack and how much slack.

FIGURE 19.17
MS Excel worksheet solution for microcomputer problem

Source: Microsoft

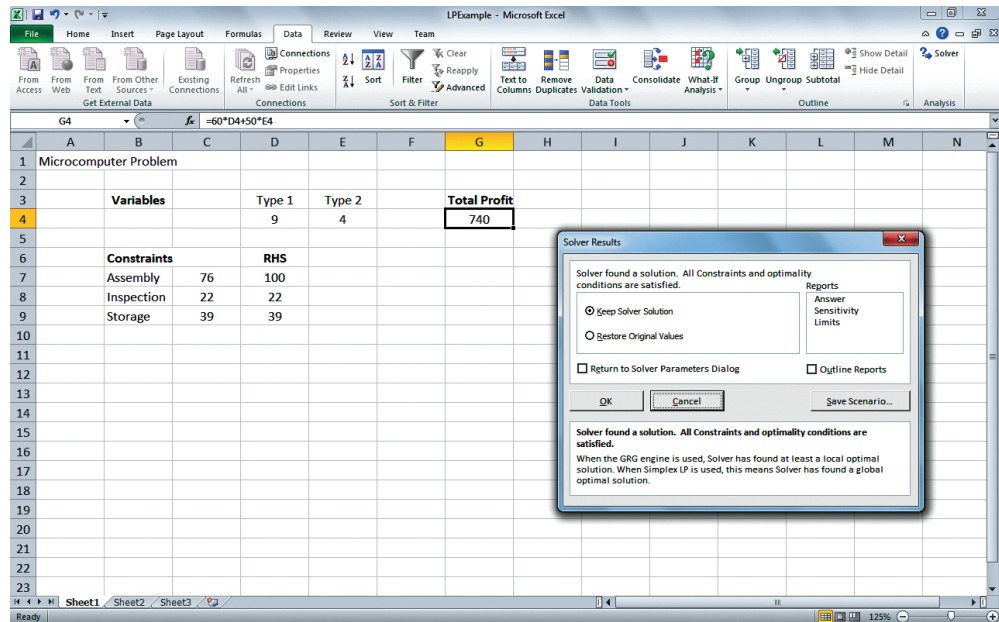
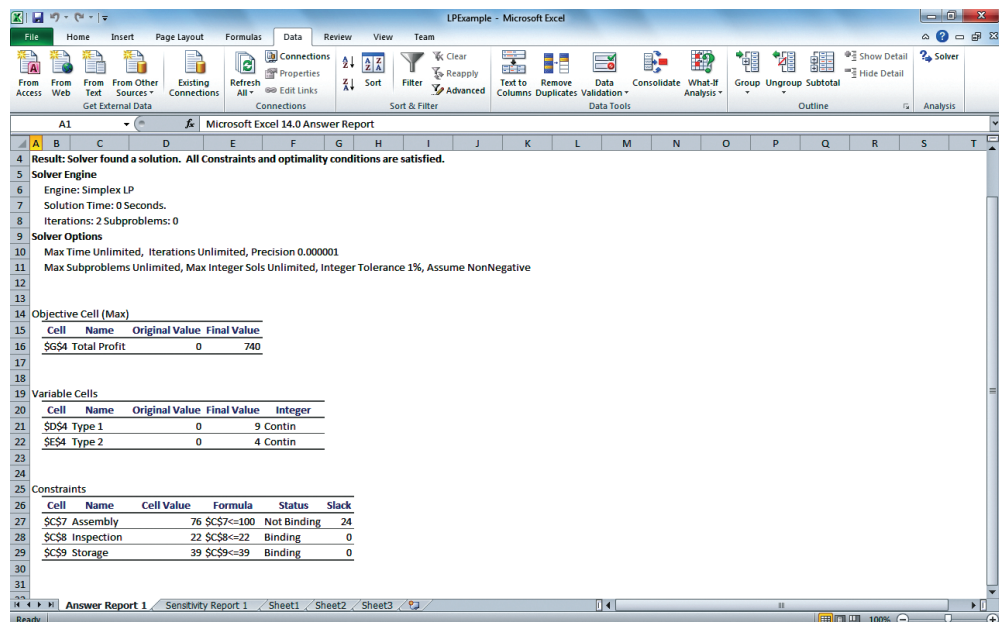

FIGURE 19.18
MS Excel Answer Report for microcomputer problem

Source: Microsoft



Notice that the constraint entered in cell C7 (assembly) has a slack of 24, and that the constraints entered in cells C8 (inspection) and C9 (storage) have a slack equal to zero, indicating they are binding constraints.

19.6 SENSITIVITY ANALYSIS

Sensitivity analysis is a means of assessing the impact of potential changes to the parameters (the numerical values) of an LP model. Such changes may occur due to forces beyond a manager's control, or a manager may be contemplating making the changes, say, to increase profits or reduce costs.

There are three types of potential changes:

- Objective function coefficients
- Right-hand values of constraints
- Constraint coefficients

We will discuss the first two of these here, beginning with changes to objective function coefficients.

Objective Function Coefficient Changes

A change in the value of an objective function coefficient can cause a change in the optimal solution of a problem. In a graphical solution, this would mean a change to another corner point of the feasible solution space. However, not every change in the value of an objective function coefficient will lead to a changed solution—generally, there is a *range of values for which the optimal values of the decision variables will not change*. For example, in the microcomputer problem, if the profit on type 1 computers increased from \$60 per unit to, say, \$65 per unit, the optimal solution would still be to produce nine units of type 1 and four units of type 2 computers. Similarly, if the profit per unit on type 1 computers decreased from \$60 to, say, \$58, producing nine of type 1 and four of type 2 would still be optimal. These sorts of changes are not uncommon; they may be the result of such things as price changes in raw materials, price discounts, cost reductions in production, and so on. Obviously, when a change does occur in the value of an objective function coefficient, it can be helpful for a manager to know if that change will affect the optimal values of the decision variables. The manager can quickly determine this by referring to that coefficient's **range of optimality**, which is the range in possible values of that objective function coefficient over which the optimal values of the decision variables will not change. Before we see how to determine the range, consider the implication of the range. The range of optimality for the type 1 coefficient in the microcomputer problem is 50 to 100. That means that as long as the coefficient's value is in that range, the optimal values will be nine units of type 1 and four units of type 2. Conversely, *if a change extends beyond the range of optimality, the solution will change*.

Similarly, suppose instead that the coefficient (unit profit) of type 2 computers was to change. Its range of optimality is 30 to 60. As long as the change doesn't take it outside of this range, nine and four will still be the optimal values. Note, however, even for changes that are *within* the range of optimality, the optimal value of the objective function *will* change. If the type 1 coefficient increased from \$60 to \$61, and nine units of type 1 is still optimum, profit would increase by \$9: nine units times \$1 per unit. Thus, for a change that is within the range of optimality, a revised value of the objective function must be determined.

Now let's see how we can determine the range of optimality using computer output.

Using MS Excel. There is a table for the Changing Cells (see Figure 19.19). It shows the value of the objective function that was used in the problem for each type of computer (i.e., 60 and 50), and the allowable increase and allowable decrease for each coefficient. By subtracting the allowable decrease from the original value of the coefficient, and adding the

Sensitivity analysis

Assessing the impact of potential changes to the numerical values of an LP model.

LO19.5 Do sensitivity analysis on the solution to a linear programming problem.

Range of optimality Range of values over which the solution quantities of all the decision variables remain the same.

FIGURE 19.19

MS Excel sensitivity report for microcomputer problem

Source: Microsoft

Variable Cells					
Cell	Name	Final Value	Reduced Cost	Objective Coefficient	Allowable Increase
\$D\$4	Type 1	9	0	60	40
\$E\$4	Type 2	4	0	50	10

Constraints					
Cell	Name	Final Value	Shadow Price	Constraint R.H. Side	Allowable Increase
\$C\$7	Assembly	76	0	100	1E+30
\$C\$8	Inspection	22	10	22	4
\$C\$9	Storage	39	13.33333333	39	4.5

allowable increase to the original value of the coefficient, we obtain the range of optimality for each coefficient. Thus, we find for type 1:

$$60 - 10 = 50 \text{ and } 60 + 40 = 100$$

Hence, the range for the type 1 coefficient is 50 to 100. For type 2:

$$50 - 20 = 30 \text{ and } 50 + 10 = 60$$

Hence, the range for the type 2 coefficient is 30 to 60.

In this example, both of the decision variables are *basic* (i.e., nonzero). However, in other problems, one or more decision variables may be *nonbasic* (i.e., have an optimal value of zero). In such instances, unless the value of that variable's objective function coefficient increases by more than its *reduced cost*, it won't come into solution (i.e., become a basic variable). Hence, the range of optimality (sometimes referred to as the *range of insignificance*) for a nonbasic variable is from negative infinity to the sum of its current value and its reduced cost.

Now let's see how we can handle multiple changes to objective function coefficients—that is, a change in more than one coefficient. To do this, divide each coefficient's change by the allowable change in the same direction. Thus, if the change is a decrease, divide that amount by the allowable decrease. Treat all resulting fractions as positive. Sum the fractions. If the sum does not exceed 1.00, then multiple changes are within the range of optimality and will not result in any change to the optimal values of the decision variables.

Changes in the Right-Hand-Side (RHS) Value of a Constraint

In considering right-hand-side (RHS) changes, it is important to know if a particular constraint is binding on a solution. A constraint is binding if substituting the values of the decision variables of that solution into the left-hand side of the constraint results in a value that is equal to the RHS value. In other words, that constraint stops the objective function from achieving a better value (e.g., a greater profit or a lower cost). Each constraint has a corresponding **shadow price**, which is a marginal value that indicates the amount by which the value of the objective function would change if there were a one-unit change in the RHS value of that constraint. If a constraint is nonbinding, its shadow price is zero, meaning that increasing or decreasing its RHS value by one unit will have no impact on the value of the objective

Shadow price Amount by which the value of the objective function would change with a one-unit change in the RHS value of a constraint.

function. Nonbinding constraints have either slack (if the constraint is \leq) or surplus (if the constraint is \geq). Suppose a constraint has 10 units of slack in the optimal solution, which means 10 units that are unused. If we were to increase or decrease the constraint's RHS value by one unit, the only effect would be to increase or decrease its slack by one unit. But there is no profit associated with slack, so the value of the objective function wouldn't change. On the other hand, if the change is to the RHS value of a binding constraint, then the optimal value of the objective function would change. Any change in a binding constraint will cause the optimal values of the decision variables to change, and thus cause the value of the objective function to change. For example, in the microcomputer problem, the inspection constraint is a binding constraint: It has a shadow price of 10. That means if there was one hour less of inspection time, total profit would decrease by \$10, or if there was one more hour of inspection time available, total profit would increase by \$10. In general, multiplying the amount of change in the RHS value of a constraint by the constraint's shadow price will indicate the change's impact on the optimal value of the objective function. However, this is only true over a limited range called the **range of feasibility**. In this range, the value of the shadow price remains constant. Hence, as long as a change in the RHS value of a constraint is within its range of feasibility, the shadow price will remain the same, and one can readily determine the impact on the objective function.

Let's see how to determine the range of feasibility from computer output.

Using MS Excel. In the sensitivity report, there is a table labeled "Constraints" (see Figure 19.19). The table shows the shadow price for each constraint, its RHS value, and the allowable increase and allowable decrease. Adding the allowable increase to the RHS value and subtracting the allowable decrease will produce the range of feasibility for that constraint. For example, for the inspection constraint, the range would be

$$22 - 4 = 18; 22 + 4 = 26$$

Hence, the range of feasibility for inspection is 18 to 26 hours. Similarly, for the storage constraint, the range is

$$39 - 6 = 33 \text{ to } 39 + 4.5 = 43.5$$

The range for the assembly constraint is a little different; the assembly constraint is nonbinding (note the shadow price of 0) while the other two are binding (note their nonzero shadow prices). The assembly constraint has a slack of 24 (the difference between its RHS value of 100 and its final value of 76). With its slack of 24, its RHS value could be decreased by as much as 24 (to 76) before it would become binding. Conversely, increasing its right-hand side will only produce more slack. Thus, no amount of increase in the RHS value will make it binding, so there is no upper limit on the allowable increase. Excel indicates this by the large value (1E + 30) shown for the allowable increase. So its range of feasibility has a lower limit of 76 and no upper limit.

If there are changes to more than one constraint's RHS value, analyze these in the same way as multiple changes to objective function coefficients. That is, if the change is an increase, divide that amount by that constraint's allowable increase; if the change is a decrease, divide the decrease by the allowable decrease. Treat all resulting fractions as positives. Sum the fractions. As long as the sum does not exceed 1.00, the changes are within the range of feasibility for multiple changes, and the shadow prices won't change.

Table 19.1 summarizes the impacts of changes that fall within either the range of optimality or the range of feasibility.

Now let's consider what happens if a change goes beyond a particular range. In a situation involving the range of optimality, a change in an objective function that is beyond the range of optimality will result in a new solution. Hence, it will be necessary to recompute the solution. For a situation involving the range of feasibility, there are two cases to consider. The first case would be increasing the RHS value of a \leq constraint to beyond the upper limit of its range of feasibility. This would produce slack equal to the amount by which the upper limit is exceeded. Hence, if the upper limit is 200, and the increase is 220, the result is that the

Range of feasibility Range of values for the RHS of a constraint over which the shadow price remains the same.

TABLE 19.1

Summary of the impact of changes within their respective ranges

Changes to objective function coefficients that are within the range of optimality	
Component	Result
Values of decision variables	No change
Value of objective function	Will change
Changes to RHS values of constraints that are within the range of feasibility	
Component	Result
Value of shadow price	No change
List of basic variables	No change
Values of basic variables	Will change
Value of objective function	Will change

constraint has a slack of 20. Similarly, for a \geq constraint, going below its lower bound creates a surplus for that constraint. The second case for each of these would be exceeding the opposite limit (the lower bound for a \leq constraint, or the upper bound for a \geq constraint). In either instance, a new solution would have to be generated.

SUMMARY

Linear programming is a powerful tool used for constrained optimization situations. Components of LP problems include an objective function, decision variables, constraints, and numerical values (parameters) of the objective function and constraints.

The size of real-life problems and the burden of manual solution make computer solutions the practical way to solve real-life problems. Even so, much insight can be gained through the study of simple, two-variable problems and graphical solutions.

KEY POINTS

1. Optimizing techniques such as linear programming help business organizations make the best use of limited resources, such as materials, time, and energy, to maximize profits or to minimize costs.
2. As with all techniques, it is important to confirm that the underlying assumptions on which the technique is based are reasonably satisfied by the model in order to achieve valid results.
3. Although the graphical technique has limited use due to the fact that it can only handle two-variable problems, it is very useful in conveying many of the important concepts associated with linear programming techniques.

KEY TERMS

- | | | |
|---------------------------|-----------------------------------|---------------------------|
| binding constraint, 839 | graphical linear programming, 828 | redundant constraint, 836 |
| constraints, 826 | objective function, 826 | sensitivity analysis, 843 |
| decision variables, 826 | parameters, 826 | shadow price, 844 |
| enumeration approach, 837 | range of feasibility, 845 | simplex, 840 |
| feasible solution | range of optimality, 843 | slack, 839 |
| space, 826 | | surplus, 839 |

SOLVED PROBLEMS

Problem 1

A small construction firm specializes in building and selling single-family homes. The firm offers two basic types of houses: model A and model B. Model A houses require 4,000 labor hours, 2 tons of stone, and 2,000 board feet of lumber. Model B houses require 10,000 labor hours, 3 tons of stone, and 2,000 board feet of lumber. Due to long lead times for ordering supplies and the scarcity of skilled and semiskilled workers in the area, the firm will be forced to rely on its present resources for the upcoming building season. It has 400,000 hours of labor, 150 tons of stone, and 200,000 board feet of lumber. What mix of model A and B houses should the firm construct if model A yields a

profit of \$3,000 per unit and model B yields \$6,000 per unit? Assume that the firm will be able to sell all the units it builds.

1. Formulate the objective function and constraints:¹

$$\text{Maximize } Z = 3,000A + 6,000B$$

Subject to

$$\begin{array}{rcl} \text{Labor} & 4,000A + 10,000B & \leq 400,000 \text{ labor hours} \\ \text{Stone} & 2A + 3B & \leq 150 \text{ tons} \\ \text{Lumber} & 2,000A + 2,000B & \leq 200,000 \text{ board feet} \\ & A, B & \geq 0 \end{array}$$

2. Graph the constraints and objective function, and identify the optimum corner point (see graph). Note that the lumber constraint is *redundant*: It does not form a boundary of the feasible solution space.

Solution

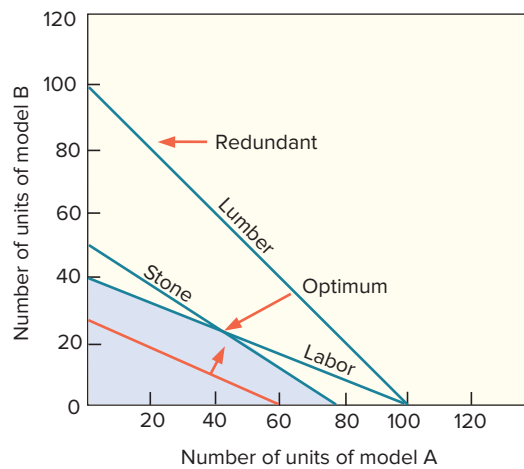

3. Determine the optimal quantities of models A and B, and compute the resulting profit. Because the optimum point is at the intersection of the stone and labor constraints, solve those two equations for their common point:

$$\begin{array}{r} \text{Labor } 4,000A + 10,000B = 400,000 \\ -2,000 \times (\text{Stone } 2A + 3B = 150) \\ \hline 4,000B = 100,000 \\ B = 25 \end{array}$$

Substitute $B = 25$ in one of the equations, and solve for A:

$$2A + 3(25) = 150 \quad A = 37.5$$

$$Z = 3,000(37.5) + 6,000(25) = 262,500$$

4. We could have used the enumeration approach to find the optimal corner point. The corner points and the value of the objective function at each corner point are:

$$A = 0, B = 40 \text{ (found by inspection); } Z = 3,000(0) + 6,000(40) = 240,000$$

$$A = 37.5, B = 25 \text{ (found using simultaneous equations); } Z = 262,500 \text{ (see step 3)}$$

$$A = 75, B = 0 \text{ (found by inspection); } Z = 3,000(75) + 6,000(0) = 225,000$$

The best value of Z is 262,500 (because this is a maximization problem), so that indicates that the optimal corner point is $A = 37.5, B = 25$.

¹For the sake of consistency, we will assign to the horizontal axis the first decision variable mentioned in the problem. In this case, variable A will be represented on the horizontal axis, and variable B on the vertical axis.

Problem 2 This LP model was solved by computer:

$$\begin{aligned} \text{Maximize } & 15x_1 + 20x_2 + 14x_3 & \text{where } & x_1 = \text{quantity of product 1} \\ & & & x_2 = \text{quantity of product 2} \\ & & & x_3 = \text{quantity of product 3} \end{aligned}$$

Subject to:

$$\begin{aligned} \text{Labor} & 5x_1 + 6x_2 + 4x_3 \leq 210 \text{ hours} \\ \text{Material} & 10x_1 + 8x_2 + 5x_3 \leq 200 \text{ pounds} \\ \text{Machine} & 4x_1 + 2x_2 + 5x_3 \leq 170 \text{ minutes} \\ & x_1, x_2, x_3 \geq 0 \end{aligned}$$

The following information was obtained from the output. The ranges were also computed based on the output, and they are shown as well.

TOTAL PROFIT = 548.00

Variable	Value	Reduced Cost	Range of Optimality
Product 1	0	10.6	unlimited to 25.60
Product 2	5	0	9.40 to 22.40
Product 3	32	0	12.50 to 50.00
Constraint	Slack	Shadow Price	Range of Feasibility
Labor	52	0.0	158.00 to unlimited
Material	0	2.4	170.00 to 270.91
Machine	0	0.4	50.00 to 200.00

- Which decision variables are basic (i.e., in solution)?
- By how much would the profit per unit of product 1 have to increase for it to have a nonzero value (i.e., for it to become a basic variable)?
- If the profit per unit of product 2 increased by \$2 to \$22, would the optimal production quantities of products 2 and 3 change? Would the optimal value of the objective function change?
- If the available amount of labor decreased by 12 hours, would that cause a change in the optimal values of the decision variables or the optimal value of the objective function? Would anything change?
- If the available amount of material increased by 10 pounds to 210 pounds, how would that affect the optimal value of the objective function?
- If profit per unit on product 2 increased by \$1 and profit per unit on product 3 decreased by \$.50, would that fall within the range of multiple changes? Would the values of the decision variables change? What would be the revised value of the objective function?

Solution

- Products 2 and 3 are in solution (i.e., have nonzero values). The optimal value of product 2 is 5 units, and the optimal value of product 3 is 32 units.
- The amount of increase would have to equal its *reduced cost* of \$10.60.
- No, because the change would be within its range of optimality, which has an upper limit of \$22.40. The objective function value would increase by an amount equal to the quantity of product 2 and its increased unit profit. Hence, it would increase by $5(\$2) = \10 to \$558.
- Labor has a slack of 52 hours. Consequently, the only effect would be to decrease the slack to 40 hours.
- The change is within the range of feasibility. The objective function value will increase by the amount of change multiplied by material's shadow price of \$2.40. Hence, the objective function value would increase by $10(\$2.40) = \24.00 . (*Note:* If the change had been a *decrease* of 10 pounds, which is also within the range of feasibility, the value of the objective function would have *decreased* by this amount.)
- To determine if the changes are within the range for multiple changes, we first compute the ratio of the amount of each change to the end of the range *in the same direction*. For product 2, it is $\$1/\$2.40 = .417$; for product 3, it is $-\$.50/ -\$1.50 = .333$. Next, we compute the sum of these ratios: $.417 + .333 = .750$. Because this does not exceed 1.00, we conclude that these changes are within the range. This means the optimal values of the decision variables will not change. We can compute the change to the value of the objective function by multiplying each product's optimal quantity by its changed profit per unit: $5(\$1) + 32(-\$1.50) = -\$11$. Hence, with these changes, the value of the objective function would decrease by \$11. Its new value would be $\$548 - \$11 = \$537$.

DISCUSSION AND
REVIEW QUESTIONS

- For which decision environment is linear programming most suited?
- What is meant by the term *feasible solution space*? What determines this region?
- Explain the term *redundant constraint*.
- What is an isocost line? An isoprofit line?
- What does sliding an objective function line toward the origin represent? Away from the origin?
- Briefly explain these terms:
 - Basic variable
 - Shadow price
 - Range of feasibility
 - Range of optimality

PROBLEMS

- Solve these problems using graphical linear programming and answer the questions that follow. Use simultaneous equations to determine the optimal values of the decision variables.

a. Maximize $Z = 4x_1 + 3x_2$

Subject to

Material $6x_1 + 4x_2 \leq 48$ lb

Labor $4x_1 + 8x_2 \leq 80$ hr

$$x_1, x_2 \geq 0$$

b. Maximize $Z = 2x_1 + 10x_2$

Subject to

Durability $10x_1 + 4x_2 \geq 40$ wk

Strength $1x_1 + 6x_2 \geq 24$ psi

Time $1x_1 + 2x_2 \leq 14$ hr

$$x_1, x_2 \geq 0$$

c. Maximize $Z = 6A + 3B$ (revenue)

Subject to

Material $20A + 6B \leq 600$ lb

Machinery $25A + 20B \leq 1,000$ hr

Labor $20A + 30B \leq 1,200$ hr

$$A, B \geq 0$$

- What are the optimal values of the decision variables and Z ?
 - Do any constraints have (nonzero) slack? If yes, which one(s) and how much slack does each have?
 - Do any constraints have (nonzero) surplus? If yes, which one(s) and how much surplus does each have?
 - Are any constraints redundant? If yes, which one(s)? Explain briefly.
- Solve these problems using graphical linear programming and then answer the questions that follow. Use simultaneous equations to determine the optimal values of the decision variables.

a. Minimize $Z = 1.80S + 2.20T$

Subject to:

Potassium $5S + 8T \geq 200$ gr

Carbohydrate $15S + 6T \geq 240$ gr

Protein $4S + 12T \geq 180$ gr

$T \geq 10$ gr

$$S, T \geq 0$$

b. Minimize $Z = 2x_1 + 3x_2$

Subject to:

D $4x_1 + 2x_2 \geq 20$

E $2x_1 + 6x_2 \geq 18$

F $1x_1 + 2x_2 \leq 12$

$$x_1, x_2 \geq 0$$

- What are the optimal values of the decision variables and Z ?
- Do any constraints have (nonzero) slack? If yes, which one(s) and how much slack does each have?
- Do any constraints have (nonzero) surplus? If yes, which one(s) and how much surplus does each have?
- Are any constraints redundant? If yes, which one(s)? Explain briefly.

3. a. An appliance manufacturer produces two models of microwave ovens: H and W. Both models require fabrication and assembly work; each H uses four hours of fabrication and two hours of assembly, and each W uses two hours of fabrication and six hours of assembly. There are 600 fabrication hours available this week and 480 hours of assembly. Each H contributes \$40 to profits, and each W contributes \$30 to profits. What quantities of H and W will maximize profit? (1) Use the objective function method. (2) Use the enumeration method.
- b. The company also produces two refrigerator models: large (L) and medium (M). Although materials to produce the refrigerators is available, fabrication time and assembly time are limited. There are 540 hours available for fabrication and 600 hours available for assembly this week. Each unit of model L requires 6 hours for fabrication and 3 hours for assembly, and each unit of M requires 4 hours for fabrication and 5 hours for assembly. Each unit of L contributes \$50 to profit, and each unit of model M contributes \$40 to profit. How many units of each model should be produced if the objective is to maximize profit? (1) Use the objective function method. (2) Use the enumeration method.
4. A small candy shop is preparing for the holiday season. The owner must decide how many bags of deluxe mix and how many bags of standard mix of Peanut/Raisin Delite to put up. The deluxe mix has $\frac{2}{3}$ pound raisins and $\frac{1}{3}$ pound peanuts, and the standard mix has $\frac{1}{2}$ pound raisins and $\frac{1}{2}$ pound peanuts per bag. The shop has 90 pounds of raisins and 60 pounds of peanuts to work with.
Peanuts cost \$.60 per pound and raisins cost \$1.50 per pound. The deluxe mix will sell for \$2.90 for a one-pound bag, and the standard mix will sell for \$2.55 for a one-pound bag. The owner estimates that no more than 110 bags of one type can be sold.
- a. If the goal is to maximize profits, how many bags of each type should be prepared?
- b. What is the expected profit?
5. A retired couple supplement their income by making fruit pies, which they sell to a local grocery store. During the month of September, they produce apple and grape pies. The apple pies are sold for \$4.50 to the grocer, and the grape pies are sold for \$3.60. The couple is able to sell all of the pies they produce owing to their high quality. They use fresh ingredients. Flour and sugar are purchased once each month. For the month of September, they have 1,200 cups of sugar and 2,100 cups of flour. Each apple pie requires $1\frac{1}{2}$ cups of sugar and 3 cups of flour, and each grape pie requires 2 cups of sugar and 3 cups of flour.
- a. Determine the number of grape and the number of apple pies that will maximize revenues if the couple working together can make an apple pie in six minutes and a grape pie in three minutes. They plan to work no more than 60 hours.
- b. Determine the amounts of sugar, flour, and time that will be unused.
6. Solve each of these problems by computer and obtain the optimal values of the decision variables and the objective function.
- a. Maximize $Z = 4x_1 + 2x_2 + 5x_3$
Subject to:
- $$\begin{aligned} 1x_1 + 2x_2 + 1x_3 &\leq 25 \\ 1x_1 + 4x_2 + 2x_3 &\leq 40 \\ 3x_1 + 3x_2 + 1x_3 &\leq 30 \\ x_1, x_2, x_3 &\geq 0 \end{aligned}$$
- b. Maximize $Z = 10x_1 + 6x_2 + 3x_3$
Subject to:
- $$\begin{aligned} 1x_1 + 1x_2 + 2x_3 &\leq 25 \\ 2x_1 + 1x_2 + 4x_3 &\leq 40 \\ 1x_1 + 2x_2 + 3x_3 &\leq 40 \\ x_1, x_2, x_3 &\geq 0 \end{aligned}$$
7. For Problem 6a, determine the following:
- a. The range of feasibility for each constraint
- b. The range of optimality for the coefficients of the objective function
8. For Problem 6b:
- a. Find the range of feasibility for each constraint, and interpret your answers.
- b. Determine the range of optimality for each coefficient of the objective function. Interpret your results.

9. A small firm makes three similar products, which all follow the same three-step process, consisting of milling, inspection, and drilling. Product A requires 12 minutes of milling, 5 minutes for inspection, and 10 minutes of drilling per unit; product B requires 10 minutes of milling, 4 minutes for inspection, and 8 minutes of drilling per unit; and product C requires 8 minutes of milling, 4 minutes for inspection, and 16 minutes of drilling. The department has 20 hours available during the next period for milling, 15 hours for inspection, and 24 hours for drilling. Product A contributes \$2.40 per unit to profit, product B contributes \$2.50 per unit, and product C contributes \$3.00 per unit. Determine the optimal mix of products in terms of maximizing contribution to profits for the period. Then, find the range of optimality for the profit coefficient of each variable.
10. Formulate and then solve a linear programming model of this problem, to determine how many containers of each product to produce tomorrow to maximize profits. The company makes four juice products using orange, grapefruit, and pineapple juice.

Product	Retail Price per Quart
Orange juice	\$1.00
Grapefruit juice	.90
Pineapple juice	.80
All-in-One	1.10

The All-in-One juice has equal parts of orange, grapefruit, and pineapple juice. Each product is produced in a one-quart size (there are four quarts in a gallon). On hand are 400 gallons of orange juice, 300 gallons of grapefruit juice, and 200 gallons of pineapple juice. The cost per gallon is \$2.00 for orange juice, \$1.60 for grapefruit juice, and \$1.40 for pineapple juice.

In addition, the manager wants grapefruit juice to be used for no more than 30 percent of the number of containers produced. She wants the ratio of the number of containers of orange juice to the number of containers of pineapple juice to be at least 7 to 5.

11. A wood products firm uses available time at the end of each week to make goods for stock. Currently, two products on the list of items are produced for stock: a chopping board and a knife holder. Both items require three operations: cutting, gluing, and finishing. The manager of the firm has collected the following data on these products.

Item	Profit/Unit	TIME PER UNIT (MINUTES)		
		Cutting	Gluing	Finishing
Chopping board	\$2	1.4	5	12
Knife holder	\$6	0.8	13	3

The manager has also determined that, during each week, 56 minutes are available for cutting, 650 minutes are available for gluing, and 360 minutes are available for finishing.

- Determine the optimal quantities of the decision variables if the goal is to maximize profit.
 - Which resources are not completely used by your solution? How much of each resource is unused?
12. The manager of the deli section of a grocery superstore has just learned that the department has 112 pounds of mayonnaise, of which 70 pounds is approaching its expiration date and must be used. To use up the mayonnaise, the manager has decided to prepare two items: a ham spread and a deli spread. Each pan of the ham spread will require 1.4 pounds of mayonnaise, and each pan of the deli spread will require 1.0 pound. The manager has received an order for 10 pans of ham spread and 8 pans of the deli spread. In addition, the manager has decided to have at least 10 pans of each spread available for sale. Both spreads will cost \$3 per pan to make, but ham spread sells for \$5 per pan, and deli spread sells for \$7 per pan.
- Determine the solution that will minimize cost.
 - Determine the solution that will maximize profit.
13. A manager wants to know how many units of each product to produce on a daily basis to achieve the highest profit. Production requirements for the products are shown in the following table.

Product	Material 1 (pounds)	Material 2 (pounds)	Labor (hours)
A	2	3	3.2
B	1	5	1.5
C	6	—	2.0

Material 1 costs \$5 a pound, material 2 costs \$4 a pound, and labor costs \$10 an hour. Product A sells for \$80 a unit, product B sells for \$90 a unit, and product C sells for \$70 a unit. Available resources each day are 200 pounds of material 1; 300 pounds of material 2; and 150 hours of labor.

The manager must satisfy certain output requirements: The output of product A should not be more than one-third of the total number of units produced; the ratio of units of product A to units of product B should be 3 to 2; and there is a standing order for 5 units of product A each day. Formulate a linear programming model for this problem, and then solve.

14. A chocolate maker has contracted to operate a small candy counter in a fashionable store. To start with, the selection of offerings will be intentionally limited. The counter will offer a regular mix of candy made up of equal parts of cashews, raisins, caramels, and chocolates, and a deluxe mix that is one-half cashews and one-half chocolates, which will be sold in one-pound boxes. In addition, the candy counter will offer individual one-pound boxes of cashews, raisins, caramels, and chocolates.

A major attraction of the candy counter is that all candies are made fresh at the counter. However, storage space for supplies and ingredients is limited. Bins are available that can hold the amounts shown in the table.

Ingredient	Capacity (pounds per day)
Cashews	120
Raisins	200
Caramels	100
Chocolates	160

In order to present a good image and to encourage purchases, the counter will make at least 20 boxes of each type of product each day. Any leftover boxes at the end of the day will be removed and given to a nearby nursing home for goodwill.

The profit per box for the various items has been determined as follows.

Item	Profit per Box
Regular	\$.80
Deluxe	.90
Cashews	.70
Raisins	.60
Caramels	.50
Chocolates	.75

- a. Formulate the LP model.
b. Solve for the optimal values of the decision variables and the maximum profit.
15. Given this linear programming model, solve the model and then answer the questions that follow. Maximize $Z = 12x_1 + 18x_2 + 15x_3$ where x_1 = the quantity of product 1 to make, etc.

Subject to:

$$\begin{array}{rcl}
 \text{Machine} & 5x_1 + 4x_2 + 3x_3 & \leq 160 \text{ minutes} \\
 \text{Labor} & 4x_1 + 10x_2 + 4x_3 & \leq 288 \text{ hours} \\
 \text{Materials} & 2x_1 + 2x_2 + 4x_3 & \leq 200 \text{ pounds} \\
 \text{Product 2} & & x_2 \leq 16 \text{ units} \\
 & & x_1, x_2, x_3 \geq 0
 \end{array}$$

- a. Are any constraints binding? If so, which one(s)?

- b. If the profit on product 3 were changed to \$22 a unit, what would the values of the decision variables be? The objective function? Explain.
- c. If the profit on product 1 were changed to \$22 a unit, what would the values of the decision variables be? The objective function? Explain.
- d. If 10 hours less of labor time were available, what would the values of the decision variables be? The objective function? Explain.
- e. If the manager decided that as many as 20 units of product 2 could be produced (instead of 16), how much additional profit would be generated?
- f. If profit per unit on each product increased by \$1, would the optimal values of the decision variables change? Explain. What would the optimal value of the objective function be?
16. A garden store prepares various grades of pine bark for mulch: nuggets (x_1), mini-nuggets (x_2), and chips (x_3). The process requires pine bark, machine time, labor time, and storage space. The following model has been developed.

Maximize $Z = 9x_1 + 9x_2 + 6x_3$ (profit)

Subject to:

$$\begin{array}{rcll} \text{Bark} & 5x_1 + 6x_2 + 3x_3 & \leq & 600 \text{ pounds} \\ \text{Machine} & 2x_1 + 4x_2 + 5x_3 & \leq & 600 \text{ minutes} \\ \text{Labor} & 2x_1 + 4x_2 + 3x_3 & \leq & 480 \text{ hours} \\ \text{Storage} & 1x_1 + 1x_2 + 1x_3 & \leq & 150 \text{ bags} \\ & x_1, x_2, x_3 & \geq & 0 \end{array}$$

- a. What is the marginal value of a pound of pine bark? Over what range is this price value appropriate?
- b. What is the maximum price the store would be justified in paying for additional pine bark?
- c. What is the marginal value of labor? Over what range is this value in effect?
- d. The manager obtained additional machine time through better scheduling. How much additional machine time can be effectively used for this operation? Why?
- e. If the manager can obtain *either* additional pine bark or additional storage space, which one should she choose and how much (assuming additional quantities cost the same as usual)?
- f. If a change in the chip operation increased the profit on chips from \$6 per bag to \$7 per bag, would the optimal quantities change? Would the value of the objective function change? If so, what would the new value(s) be?
- g. If profits on chips increased to \$7 per bag, and profits on nuggets decreased by \$.60, would the optimal quantities change? Would the value of the objective function change? If so, what would the new value(s) be?
- h. If the amount of pine bark available decreased by 15 pounds, machine time decreased by 27 minutes, and storage capacity increased by five bags, would this fall in the range of feasibility for multiple changes? If so, what would the value of the objective function be?

CASE



SON, LTD.

Son, Ltd., manufactures a variety of chemical products used by lawn care companies. Son was recently bought out by a conglomerate, and managers of the two organizations have been working together to improve the efficiency of Son's operations.

Managers have been asked to adhere to weekly operating budgets and to develop operating plans using quantitative methods whenever possible. The manager of one department has been given a weekly operating budget of \$11,980 for production of three chemical products, which for convenience shall be referred

to as Q, R, and W. The budget is intended to pay for direct labor and materials. Processing requirements for the three products, on a per-unit basis, are shown in the table.

Product	Labor (hours)	Material A (pounds)	Material B (pounds)
Q	5	2	1
R	4	2	—
W	2	½	2

(continued)

(concluded)

The company has a contractual obligation for 85 units of product R per week.

Material A costs \$4 per pound, as does material B. Labor costs \$8 an hour.

Product Q sells for \$122 a unit, product R sells for \$115 a unit, and product W sells for \$76 a unit.

The manager is considering a number of different proposals regarding the quantity of each product to produce. The manager is primarily interested in maximizing contribution. Moreover, the manager wants to know how much labor will be needed, as well as the amount of each material to purchase.

Questions

Prepare a report that addresses the following issues:

1. The optimal quantities of products and the necessary quantities of labor and materials.
2. One proposal is to make equal amounts of the products. What amount of each will maximize contribution, and what quantities of labor and materials will be needed? How much less will total contribution be if this proposal is adopted?
3. How would you formulate the constraint for material A if it was determined that there is a 5 percent waste factor for material A and equal quantities of each product are required?

CASE



CUSTOM CABINETS, INC.

Custom Cabinets, Inc. (CCI) manufactures two major lines of kitchen and bathroom cabinets. The SemiCustom Line consists of cabinets that are variations on a standard design. These cabinets are made to order. The StandardLine is a lower-priced line of cabinets that use standardized designs and materials. StandardLine cabinets are made to stock. The company has been in business for many years and has consistently performed well financially.

It was obvious that something big was up as the management staff began to gather for a meeting called by CCI General Manager John Fleming. There was little of the usual light banter, and more significantly, there were no coffee and donuts. The CCI culture celebrates even small achievements with coffee and donuts. Their absence was not a good omen.

John began rather somberly. “As you know, we are almost two months into our second fiscal quarter. Frankly, the financial results don’t look very good. You are aware, I’m sure, of how the stock market has been punishing companies that fail to at least meet their sales and profit targets. We are in danger of having to announce that we met our sales goals but fell short of our profit goals. This will be a real jolt to our shareholders, and since, except for the interns, we are all in the company’s stock purchase plan, that means it will hurt us, too. We only have one month to turn this around. We don’t want to take any shortcut approaches to meeting our goals—we want the results to reflect the real results of our operation.

“The headquarters brass talked with a consultant who analyzed our records. Her opinion is that we need to address operations efficiency. In her words, we have to learn to get more out of our existing resources. She leaves the details to us to figure out. Our biggest personnel resource to assign to this problem is our group of management interns from Nearby University. I’ve talked

to the interns and alerted them that for the next month or so they are to work directly with Bill Chavez, our Operations Manager, on this project. The goal is to be sure that we get the maximum bang for our resource buck during the next month’s operations. We have to get the most profit possible to make the quarter’s results look at least respectable. Needless to say, I want each of you to give the intern group your fullest cooperation.

“Now you understand why the interns were invited to the staff meeting. You’ve only been on board for a few weeks and have just begun to understand the company’s operations. That means the boss can’t be looking to you for engineering solutions. Your expertise is operations management, not engineering.”

As the meeting broke up, Bill Chavez asked you (the interns) to stay for a follow-up meeting with him. “I’ve been very impressed with the work that you have done in your short time with CCI. You obviously get an excellent education at Nearby U. I asked Tom to assign you to me because I think you are our best hope of pulling out some really good profit numbers. You don’t have any preconceived ideas about what will and will not work, so I expect you to come up with ideas that are more innovative than the old hands.

“I spent most of the morning with the other department heads gathering information that I think you might need—that information is enclosed with this case. If you need additional information, send me an e-mail or stop in my office. If I can get the information you need, I will do so. We’re counting on you. Don’t let us down. I’ll let you guys figure out when and where to meet. Needless to say, you have full access to all our computer resources should you need them.

“There are a few things you need to keep in mind. Our Semi-Custom Line is hot because of our excellent customer service.

We never fail to deliver a SemiCustom unit on time. We also need to meet our customer orders on the StandardLine units, but we can cut the stockage levels if necessary. We can't, however, exceed the stockage levels. Making excess inventory is no way to be more efficient. If necessary, we could work 10 percent overtime in assembly and 5 percent overtime in finishing. Each overtime hour will add \$5.00 per hour to our labor cost. I've checked with all our suppliers. We can get up to 50,000 additional board-feet of wood by paying a \$0.50 per board-foot upcharge and 10,000 additional square feet of laminate for an upcharge of \$0.15 per square foot. There is no reasonable prospect of obtaining more of the other materials at any price. Because of the way our profit center is set up, we get credit for building to the authorized stockage level as if it were a final sale."

As you were leaving the meeting, Barbara Wilson invited you to the break room for a cup of coffee. Barbara is the Lead Production Scheduler and has worked for Custom Cabinets for a long time. You have been told that she knows everything

about how things work here and is a good person to know. "I heard about your assignment," she began. "Let me tell you some things about your boss, Bill Chavez. He is a great guy to work for and he really knows his stuff. He is not one of the college guys who act as if they know everything—no offense. He worked his way up. He is very intelligent, but doesn't have the educational background that you do. In the past, new college graduates have made some mistakes in writing reports for Bill. He likes for everything in the report to be written in words he can understand. He likes you to include computer printouts in an appendix to the report—he likes to see all the backup detail—but wants you to explain in the body of the report why they are necessary and what they mean. If he doesn't understand what you are recommending and why, he won't ask questions. He will just discard the report, and that will be the last assignment you will ever do for him. I figured that the least I could do would be to buy you a cup of coffee and try to help you get off to a good start on this project."

**ENCLOSURE A
BILLS OF MATERIALS AND LABOR**

	Wood bd.-ft.	Trim lin. ft.	Granite sq. ft.	Solid Surface sq. ft.	Laminate sq. ft.	Assbly. Labor hrs.	Finish Labor hrs.
SemiCustom Line							
SC-A	125	27	175	0	0	37	7
SC-B	160	42	243	0	0	57	12
SC-C	140	35	0	160	0	30	5
SC-D	200	52	0	140	0	35	7
StandardLine							
S-10	60	21	0	112	0	21	3
S-20	110	28	0	0	135	25	5
S-30	200	50	0	0	254	30	7
S-40	180	43	0	0	176	27	5
	400,000	140,000	45,000	150,000	400,000	100,000	25,000

**ENCLOSURE B
ORDERS AND PROFITS**

	Profit/Unit @ Standard	Customer Orders Next Month	Build-to-Stock Authorization Next Month
SemiCustom Line			
SC-A	\$325	117	0
SC-B	\$575	92	0
SC-C	\$257	130	0
SC-D	\$275	150	0
StandardLine			
S-10	\$175	475	400
S-20	\$210	363	350
S-30	\$260	510	450
S-40	\$230	412	475

Questions

1. Should there be additional overtime? If so, how much?
2. Should additional laminate be purchased. If so, how much?
3. Should additional wood be purchased? If so, how much?
4. What is the maximum profit that can be achieved by purchasing additional wood?

Source: ©Victor E. Sower, 2006.

**SELECTED
BIBLIOGRAPHY AND
FURTHER READINGS**

- Anderson, David R., Dennis J. Sweeney, Thomas A. Williams, Jeffrey D. Camm, and Skip Martin. *An Introduction to Management Science: Quantitative Approaches to Decision Making*, revised 13th ed. Mason, OH: South-Western, 2012.
- Hillier, Frederick S., and Mark S. Hillier. *Introduction to Management Science: A Modeling and Case Studies Approach with Spreadsheets*, 5th ed. New York: McGraw-Hill, 2014.
- Ragsdale, Cliff T. *Spreadsheet Modeling and Decision Analysis*, 6th ed. Mason, OH: South-Western, 2011.
- Stevenson, W. J., and Ceyhun Ozgur. *Introduction to Management Science with Spreadsheets*. New York: McGraw-Hill, 2006.
- Taylor, Bernard. *Introduction to Management Science*, 11th ed. Upper Saddle River, NJ: Pearson Prentice Hall, 2013.

A

Answers to Selected Problems

CHAPTER 2: Competitiveness, Strategy, and Productivity

- Anniversary = 37.5 meals per worker
Wedding = 40 meals per worker
- Smaller crew sizes had the higher productivity.
- Week 1: 3.03
Week 2: 2.99
Week 3: 2.89
Week 4: 2.84
- a. Before: Labor productivity = 16 carts per worker per hour
After: Labor productivity = 21 carts per worker per hour
b. Before: Multifactor productivity = .89 cart per dollar
After: Multifactor productivity = .93 cart per dollar
- 11.1%
- 4.44%
- Current: \$5; A = \$6.30; B = \$6.71

CHAPTER 3: Forecasting

- a. blueberry = 33, cinnamon = 35, cupcakes = 47
b. Demand did not exceed supply.
- b. (1) 20, (2) 19, (3) 20.4, (4) 19.26, (5) 20.86
- a. 88.16 percent
b. 88.54 percent
- a. 22 b. 20.75 c. 20.72
- a. Increasing by 15,000 bottles per year
b. 170 (i.e., 170,000 bottles)
- 500 - 20t
- a. $Ft = 208.44 + 19.00t$
b. 588.44, 607.44
c. Week 31.13
- a. $Ft = 195.47 + 7.00t$
 $F_{16} = 307.47$
 $F_{17} = 314.17$
 $F_{18} = 321.47$
 $F_{19} = 328.47$
b. 307.22
- $Q_1: 127.6; Q_2: 143.5; Q_3: 105; Q_4: 273.65; Q_1 = 275$
- a. Fri. = 0.756, Sat. = 1.341, Sun. = 0.874
b. Fri. = 0.756, Sat. = 1.341, Sun. = 0.874

16. Day	a. Relative	b. Relative
1	0.901	0.887
2	0.838	0.831
3	0.884	0.876
4	1.020	1.022
5	1.430	1.438
6	1.480	1.483
7	0.450	0.464

18. b. Jan.	800	May	825.8	Sept.	700
Feb.	810	June	850	Oct.	690
Mar.	900	July	850	Nov.	672
Apr.	810	Aug.	700	Dec.	640

22. a.	MSE	MAD
Forecast 1	10.44	2.8
Forecast 2	42.44	3.6
Naive	156	10.7

- MAPE₁ = .36%
MAPE₂ = .46%
- b. \$847,000
- b. \$17.90
- b. -0.985
- b. $y = 66.44 + .58x$
d. 90.22
- a. $r = 1.96$
b. $y = -0.672 + 6.158x$
c. About 12 mowers
- a. MAD₅ = 5 b. TS₅ = 1.40
MAD₆ = 5.9 TS₆ = -0.17
MAD₇ = 4.73 TS₇ = -0.63
MAD₈ = 3.911 TS₈ = -0.26
MAD₉ = 4.238 TS₉ = -1.42
etc. etc.
- a. Initial MAD = 4.727. The tracking signal for month 15 is 4.088, so at that point, the forecast would be suspect.
b. $\Sigma \text{ errors} = -1, \Sigma \text{ errors}^2 = 345$. Control limits: 0 ± 12.38 (in limits). Plot reveals cycles in errors.

CHAPTER 4: Supplement: Reliability

- a. .81 b. .9801 c. .9783
- .9033
- .9726
- .93
- a. .9315 b. .9953 c. .994
- a. .7876 b. 0.8664, Component 4 c. 0.8681, Component 4
- a. Plan 2 (.9934)
- a. .0020 b. .0023
- .996
- .995
- .006
- a. (1) .2725 b. (1) .6671
(2) .2019 (2) .3935
(3) .1353 (3) .1813
c. (1) 21 months (3) 90 months
(2) 57 months (4) 138 months

- 13. a. .6321 b. Three months or 90 days
- 14. a. .3012 b. .1813 c. .5175
- 15. a. .2231 b. .8647 c. .0878 d. .0302
- 16. a. .2266 b. .4400 c. .3830
- 17. a. (1) .9772 b. Approximately zero
 (2) .5000 c. (1) 4.97 years
 (3) .0013 (2) 5.18 years
- 18. a. 4.97 years b. 5.18 years
- 19. a. .93 b. .98

CHAPTER 5: Strategic Capacity Planning for Products and Services

- 1. a. Utilization = 70%
 Efficiency = 87.5%
- b. Utilization = 67%
 Efficiency = 80%
- 2. 20 jobs per week
- 3. a. 46,000 units
 b. (1) \$3,000 (2) \$8,200
 c. 126,000 units
 d. 25,556 units
- 4. a. A: 8,000 units b. 10,000 units
 B: 7,500 units
 c. A: \$20,000
 B: \$18,000
- 5. a. 39,683 units b. \$1.71 (rounded up)
- 6. a. A: \$82
 B: \$92
 C: \$100
 c. A: 0 to less than 178
 B: Never
 C: 178 +
 d. 1/3 day, 2/3 evening
- 7. Vendor best for $Q < 63,333$. For larger quantities, produce in-house at \$4 per unit.
- 8. a. Vendor B is best for 10,000 and 20,000.
- 9. 3 cells
- 11. a. Buy 2 Bs b. Buy 2 Bs
- 12. a. one: $Q = 80$. two: $Q = 152$
- 14. a. 11 units/hr
- 16. 50 units/hr
- 17. a. 15 units/hr
 b. Operation #2, increase by 5 units for a system capacity of 20 units.
- 18. 8 years

CHAPTER 5: Supplement: Decision Theory

- 1. a. Expand (80)
 b. Do nothing (50)
 c. Indifferent between do nothing and subcontract (55)
 d. Subcontract (10)
- 2. a. Expand (62) c. \$9 (000)
- 3. a. Do nothing: $P(\text{high}) < .50$
 Subcontract: $.50 < P(\text{high}) < .67$
 Expand: $P(\text{high}) > .67$

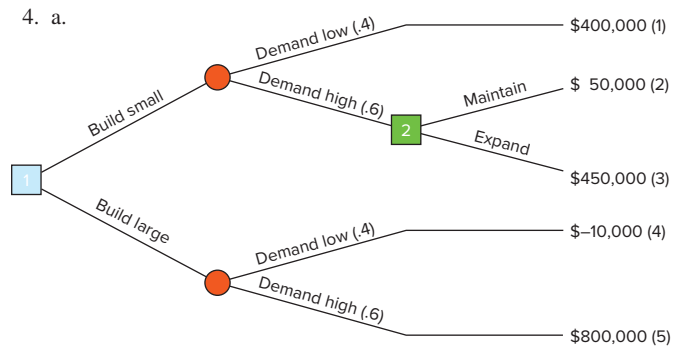

- 4. a. b. \$164,000
 c. Large 0 to .46. Small .46 to 1.00
- 5. Subcontract: \$1.23
 Expand: \$1.57
 Build: \$1.35
- 6. a. Relocate
 b. Renew
 c. Relocate
 d. Relocate
- 7. a. Renew
 b. EVPI = \$575,000
 c. Yes
- 8. a. Build large: \$53.6 million
 b. Build small: \$42 million
 c. \$12.4
 d. Build small for $P(\text{high}) < .721$
 Build large for $P(\text{high}) > .721$
- 9. Buy two (\$113.5)
- 10. A: 49
- 11. b. maximin: small
 maximax: large
 Laplace: large
 minimax regret: large
- 12. a. New staff
 b. Redesign
 c. New staff
 d. New staff or redesign
- 16. b. Alternative C
 c. $P(2) > .625$
 d. $P(1) < .375$
- 17. b. Alternative B
 c. $P(2) < .444$
 d. $P(1) > .556$

CHAPTER 6: Process Selection and Facility Layout

- 1. a. Minimum is 2.4 minutes, maximum is 18 minutes
 b. 25 units to 187.5 units c. Eight
 d. 3.6 minutes e. (1) 50 units (2) 30 units
- 2. a.

Station	Tasks	Time
1	a	1.4
2	b, e	1.3
3	d, c, f	1.8
4	g, h	1.5

3. a.

Station	Tasks	Time
1	f, a, g	14
2	d, b, c	13
3	e, h	13
4	i	5
4. a. (3) 11.54% (4) 323 copiers per day
 b. (1) 2.3 minutes (3) 182.6 copiers per day
 (4) 91.3 copiers units per day
 5. b. 2 minutes
 c. Three stations
 6. c. (1) 11.1% (2) 11.1%
 7. b. CT = .84 min or 50.4 sec
 c. $n = 3.83$ (round to 4) stations

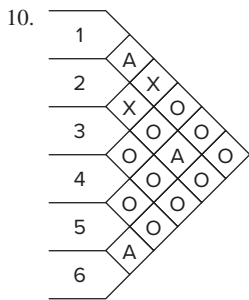

11.

1	5	4
3	8	7
6	2	

13.

3	1	8
9	7	4
5	2	6

14. a.

A #1	B #4	C #2
D #3		

 TC = \$14,150

16. A: 3; B: 5; C: 1; D: 4; E: 6; F: 2
 17. A:1; B:3; C:7; D:10; E:9; F:8; G:6; H:4; I:5; J:2

CHAPTER 7: Work Design and Measurement

1. 15.08 minutes
 2. a. 1.2 minutes
 b. 1.14 minutes
 c. 1.27 minutes
 3.

Element	OT	NT	ST
1	0.46	0.414	0.476
2	1.505	1.280	1.472
3	0.83	0.913	1.050
4	1.16	1.160	1.334

4.

Element	Average
1	4.1
2	1.5
3	3.3
4	2.8
7. 5.85 minutes
 8. 7.125 minutes
 11. 57 observations
 12. 37 cycles
 13. a. 12%
 b. 163 observations
 15. 377 observations

CHAPTER 7: Supplement: Learning Curves

1. a. 178.8 hours
 b. 1,121.4 hours
 c. 2,914.8 hours
 2. a. 41.47 hours
 b. 60.55 hours
 c. 72.20 hours
 3. a. 56.928 days
 b. 42.288 days
 c. 37.512 days
 5. a. $P = 85$ percent
 b. 26.21 minutes
 6. 87.9 minutes
 7. 201.26 hours
 8. a. 11.35 hours
 b. 13.05 hours
 c. 13.12 hours
 9. a. \$80.31
 b. 10 units
 10. B and C
 12. 30.82 hours
 13. No
 14. 18.76 hours
 15. Art: 20; Sherry: 4; Dave: 10
 16. 7 repetitions
 17. Beverly: 6; Max: 23; Antonio: 4
 19. 8.232 hours

CHAPTER 8: Location Planning and Analysis

1. Kansas City: \$256,000
 2. a. A: 16,854; B: 17,416; C: 17,753
 b. C: \$14,670
 3. a. 120 units
 b. A: 0 to 119; B: 121+
 4. a. B: 0 to 33; C: 34 to 400; A: 401+
 5. C (\$270,000)
 6. Biloxi (\$160,000)
 7. a. (1) outside; (2) city
 b. 230 cars
 9. A
 11. a. $B = C > A$
 b. $B > C > A$

- 12. (5,4) is optimal
- 13. (6,7)
- 14. (5.97, 5.95)
- 15. (3.24, 2.30)

CHAPTER 9: Management of Quality

2.

	Res.	Com.
Noisy	10	3
Failed	7	2
Odor	5	7
Warm	3	4

CHAPTER 10: Quality Control

- 1. a. .0124
b. 24.40 ounces and 24.60 ounces
- 2. a. LCL: 0.996 liter
UCL: 1.004 liters
b. Not in control
- 3. a. Mean: LCL is 3.019, UCL is 3.181
Range: LCL is 0.1845, UCL is 0.7155
b. Yes
- 4. Mean: LCL is 78.88 cm
UCL is 81.04 cm
Range: LCL is 0 cm
UCL is 3.95 cm
Process in control.
- 5. a.

1	2	3	4
.020	.010	.025	.045

 b. 2.5 percent
 c. Mean = .025, standard deviation = .011
 d. LCL = .0011, UCL = .0489
 e. .0456
 f. Yes
 g. Mean = .02, standard deviation = .01
 h. LCL = 0, UCL = .04
- 6. LCL: 0
UCL: .0234
Sample #10 is outside of the UCL
- 7. Yes, UCL = 16.266, LCL = 0
- 8. Yes, UCL = 5.17, LCL = 0
- 9. No, UCL = .10, LCL = .01. Yes
- 10. 20 pieces
- 11. One in 30 is "out." Tolerances seem to be met. Approximately 97 percent will be acceptable.
- 12. a. LCL: 3.73
UCL: 3.97
Out of control
b. Random variations

13.

Test	NUMBER OF RUNS		Standard Deviation	z	Conclude
	Observed	Expected			
a. Med ...	18	14	2.50	1.6	Random
U/D ...	17	17	2.07	0	Random
b. Med ...	8	14	2.50	-2.40	Nonrandom
U/D ...	22	17	2.07	2.41	Nonrandom

- 14. a. Random, because both z values are within ± 2
b. Nonrandom, because the z value for U/D is less than -1.96
c. Med: $z = 1.11$
U/D: $z = 0.68$
d. Med: $z = -1.11$
U/D: $z = -1.36$
- 15. Med: $z = -2.34$
U/D: $z = -1.45$
- 16. 200 pieces
- 18. a. 566 units
b. 62 units
c. \$1,160
- 19. Med: $z = +0.9177$
U/D: $z = +0.5561$
- 20. b. 4.5, .192
c. 4.5, .086
d. 4.242 to 4.758
f. None
- 21. a. 1.11
b. No
- 22. Process 005 is capable.
- 24. $C_{pk} : H = .94, K = 1.00, T = 1.33$
- 26. Melissa
- 27. a. 2.506
b. $C_{pk} = 1.41$
c. .987 ounces

CHAPTER 11: Aggregate Planning and Master Scheduling

- 1. b. \$95,500
- 2. \$57,000
- 3. \$69,000
- 4. \$69,750
- 7. a. \$31,250
b. \$31,310
- 8. a. \$350,800
b. \$356,200
c. \$353,700
- 10. B: \$14,340
C: \$14,370
- 11. \$13,475
- 12. \$13,885
- 13. \$4,970
- 15. \$124,960
- 16. \$126,650; additional cost: \$1,920

CHAPTER 12: Inventory Management

1. a.

Item	Category
1	B
2	B
3	C
4	C
5	C
6	A
7	C

b. 180 units

- | 2. a. | Item | Category | b. | Item | Category |
|-------|------|----------|----|----------------|----------|
| | K34 | C | | 4021 | A |
| | K35 | A | | 9402 | C |
| | K36 | B | | 4066 | B |
| | M10 | C | | 6500 | C |
| | M20 | C | | 9280 | C |
| | Z45 | A | | 4050 | C |
| | F14 | B | | 6850 | B |
| | F95 | A | | 3010 | C |
| | F99 | C | | 4400 | B |
| | D45 | B | | | |
| | D48 | C | c. | A: 11%, 55.26% | |
| | D52 | C | | B: 33%, 28.95% | |
| | D57 | B | | C: 56%, 15.79% | |
| | N08 | C | | | |
| | P05 | B | | | |
| | P09 | C | | | |
3. a. 18 bags
b. 9 bags
c. 67.5
d. \$1,350
e. Increase by \$78.71
4. a. 204 packages
b. \$6,118.82
c. Yes
d. No; TC = \$6,120; only save \$1.18
5. \$105.29
6. \$364
7. a. 1–6: 74 units; 7–12: 91 units
b. EOQ requirement
c. 1–6: 50 units; 7–12: 100 units
8. a. \$1.32
b. \$54.20
9. a. 4,812
b. 15.59 (approx. 16)
c. .96
10. a. 10,328 bags
b. 3,098 bags
c. 10.33 days
d. 7.75 (approx. 8)
e. \$774.50
11. a. 1,414 units
b. 7.07 days
c. 424 units
d. No
e. Approximately 54 units, \$168
12. a. 37.5 batches
b. 1,000 units
c. 625 units
d. No
13. a. 5,000 boxes
b. 3.6 orders
14. a. 600 stones
b. 600 stones
c. 150 stones on hand
15. Indifferent between 495 and 1,000 pulleys
16. A, 500 units
18. 6,600 feet
19. a. 370 units
b. 70 units
c. Both smaller
20. a. 91 pounds
b. ROP = 691 pounds
c. 50%
21. a. 8.39 gallons
b. 34 gallons, .1423
c. risk = .2981
22. 70.14 gallons
23. .1093
24. ROP = 70.14
25. a. 400 gallons
b. 45.02 gallons
26. a. 72 boxes
b. .0023
c. .0228
27. 749 pounds
28. a. 134 rolls
b. About 36 rolls
29. b. 14 cases
30. 97.26%
31.

Cycle	Order Quantity
1	623
2	657
3	562
32. a. P34: ROP = 132 units on hand
P35: ROP = 153 units on hand
b. 306 units
c. 334 units
34. 25 dozen
35. a. Nine spares
b. $C_s \leq \$10.47$
36. 78.9 pounds
37. \$4.89 per quart
38. Five cakes
39. 421.5 pounds
40. a. \$0.53 to \$1.76
c. \$56.67 to \$190.00
41. 3 spares
42. 2 cakes
43. 16 tickets

CHAPTER 13: MRP and ERP

1. a. $F = 2, G = 1, H = 1, J = 6, D = 10, L = 2, A = 4$
2. a. $E = 138$
- b. Week 5
3. a. 360
- b. Day 1 (now)

Master	Week	Beg. Inv.	1	2	3	4	5	6
Schedule	Quantity							80

E	LT = 2	Beg. Inv.	1	2	3	4	5	6
Gross requirements								80
Scheduled receipts								
Projected on hand								
Net requirements								80
Planned-order receipts								80
Planned-order releases						80		

B(2)	LT = 2	Beg. Inv.	1	2	3	4	5	6
Gross requirements						160		
Scheduled receipts								
Projected on hand		60	60	60	60	60	20	20
Net requirements						100		
Planned-order receipts						120		
Planned-order releases				120				

J(4) and J(3)	LT = 1	Beg. Inv.	1	2	3	4	5	6
Gross requirements				480		240		
Scheduled receipts					30	30	30	
Projected on hand		20	20	20	50	80	50	50
Net requirements				460		160		
Planned-order receipts				480		180		
Planned-order releases			480		180			

4. a. Master
Schedule
for: E

Week		4	5	6
Quantity				70

E Lot size: Lot-for-Lot	LT = 2	Beg. Inv.	4	5	6
Gross requirements					70
Scheduled receipts					
Projected on hand		0	0	0	0
Net requirements					70
Planned-order receipts					70
Planned-order releases			70		

B (2) Lot size: Multiples of 120	LT = 2	Beg. Inv.	4	5	6
Gross requirements			140		
Scheduled receipts			120		
Projected on hand		60	180	40	40
Net requirements					
Planned-order receipts					
Planned-order releases					

J (4) and J (3) Lot size: Multiples of 30	LT = 1	Beg. Inv.	4	5	6
Gross requirements			210		
Scheduled receipts			210	30	
Projected on hand		50	260	80	30
Net requirements					
Planned-order receipts					
Planned-order releases					

Notes:

Scheduled Receipts (Week 4) = Original amount of 30 + 180 = 210

Original on hand amounts (Week 6): B = 20 and J = 50

Revised on hand amounts (Week 6): B = 40 and J = 80

There will be an additional 20 units of B and 30 units of J on hand.

6. Master Schedule

Day	Beg. Inv.	1	2	3	4	5	6	7
Quantity					100	150		200

Table	Beg. Inv.	1	2	3	4	5	6	7
Gross requirements					100	150		200
Scheduled receipts								
Projected on hand								
Net requirements					100	150		200
Planned-order receipts					100	150		200
Planned-order releases				100	150		200	

Wood Sections (2)	Beg. Inv.	1	2	3	4	5	6	7
Gross requirements				200	300		400	
Scheduled receipts			100					
Projected on hand			100	100				
Net requirements				100	300		400	
Planned-order receipts				100	300		400	
Planned-order releases			400		400			

Braces (3)	Beg. Inv.	1	2	3	4	5	6	7
Gross requirements				300	450		600	
Scheduled receipts								
Projected on hand	60	60	60	60				
Net requirements				240	450		600	
Planned-order receipts				240	450		600	
Planned-order releases		240	450	600				

Legs (4)	Beg. Inv.	1	2	3	4	5	6	7
Gross requirements				400	600		800	
Scheduled receipts								
Projected on hand	120	120	120	120				
Net requirements				200	600		800	
Planned-order receipts				280	600		800	
Planned-order releases		880		800				

10. Order 160 units of subassembly G in week 2.

11. a. Master Schedule for E

Week number	1	2	3	4	5	6	7	8
Quantity					120			

Item: E		LT = 1 week							
	1	2	3	4	5	6	7	8	
Gross requirements					120				
Scheduled receipts									
Projected on hand									
Net requirements					120				
Planned-order receipts					120				
Planned-order releases				120					

Item: I(2)		LT = 1 week							
	1	2	3	4	5	6	7	8	
Gross requirements				240					
Scheduled receipts			40						
Projected on hand			40	40					
Net requirements				200					
Planned-order receipts				200					
Planned-order releases			200						

Item: N (4)		LT = 2 weeks							
	1	2	3	4	5	6	7	8	
Gross requirements			800						
Scheduled receipts									
Projected on hand	100	100	100						
Net requirements			700						
Planned-order receipts			700						
Planned-order releases	700								

Item: V		LT = 2 weeks							
	1	2	3	4	5	6	7	8	
Gross requirements			200						
Scheduled receipts			10						
Projected on hand									
Net requirements			190						
Planned-order receipts			190						
Planned-order releases	190								

13. c. Master Schedule for golf carts

Week number	1	2	3	4	5	6	7	8	9
Quantity						100		100	100

Item: Golf cart LT = 1 week									
Gross requirements						100		100	100
Scheduled receipts									
Projected on hand									
Net requirements						100		100	100
Planned-order receipts						100		100	100
Planned-order releases					100		100	100	

Item: Bases LT = 1 week									
Gross requirements					100		100	100	
Scheduled receipts									
Projected on hand 20	20	20	20	50	100	50	100	50	
Net requirements					0		0	50	
Planned-order receipts			30	50	50	50	50	50	
Planned-order releases		30	50	50	50	50	50		

15. Labor: 53.3% 106.7% 80% 93.3%
 Machine: 60% 120% 90% 105%

CHAPTER 14: JIT and Lean Operations

- 3
- 3
- 3
- 3 cycles
- 2 cycles:

	Cycle	
	1	2
A	11	11
B	6	6
C	2	2
D	9	9
E	4	4

CHAPTER 14: Supplement: Maintenance

- Expected recalibration cost = \$925 a month
Use the service contract.
- Expected repair cost = \$456 a month
Option #1: \$500
Option #2: \$566
- | Equipment | Ratio | Interval (days) |
|-----------|-------|-----------------|
| A201 | .1304 | 17.76 |
| B400 | .0571 | 25.26 |
| C850 | .1104 | 35.12 |

CHAPTER 15: Supply Chain Management

- Use 2-day freight.
- Use 6-day.
- Ship 2-day using A.

CHAPTER 16: Scheduling

- 1-A, 2-B, 3-C, TC = 15
- 1-B, 2-C, 3-A, TC = 21
- 1-A, 2-E, 3-D, 4-B, 5-C; or 1-A, 2-D, 3-E, 4-B, 5-C
- 1-B, 2-C, 3-D, 4-A, TC = 26
- 1-A, 2-B, 3-C, 4-D, 5-E
 - 1-E, 2-B, 3-C, 4-D, 5-A

b.	FCFS	SPT	EDD	CR
Av. flow time	26.5	19.75	21	24.75
Av. job tardiness	11	6	6	9.25
Av. no. of jobs	2.86	2.14	2.27	2.68

- FCFS: a-b-c-d-e
SPT: c-b-a-e-d
EDD: a-b-c-e-d
CR: a-b-c-e-d (or a-b-e-c-d)

	FCFS	SPT	EDD	CR
Av. flow time	17.40	14.80	16.80	16.80
Av. job tardiness	5.20	5.40	4.60	4.60
Av. no. of jobs	2.72	2.31	2.63	2.63

- B-A-G-E-F-D-C
- e-b-g-h-d-c-a-f
 - 2 hours

- 11. a. B-A-C-E-F-D
- 12. a. b-a-c-d-e
 - b. 37 minutes
 - c. both reduced by 15 minutes
- 13. G-A-E-D-B-C-F (or G-E-A-D-B-C-F)
- 14. b. Grinding flow time is 93 hours. Total time is 37 hours.
 - c. Grinding flow time is 107 hours. Total time is 35 hours.
- 15. a.

	FCFS	SPT	EDD	CR
Av. flow time	15.25	11.12	15.60	15.60
Av. job tardiness	1.7	2.33	0.55	0.55
Av. no. of jobs	3.91	2.85	4.00	4.00

 - c. a-c-b-e-d-f
- 16. b-c-e-a-d
- 19. A-B-C
- 20. C-B-A
- 21. B-C-D-A

CHAPTER 17: Project Management

- 1. a. 1-3-6-9-11-12: 31
 - b. 1-2-5-7-8-9: 55
 - c. 1-2-5-12-16: 44
- 4. a.

Activity	Immed. Pred.
A	-
B	-
C	A
D	A,B
E	C

5. a. Summary:

Activity	ES	EF	LF	LS	Slack
1-2	0	4	11	7	7
2-4	4	13	21	12	8
4-7	13	18	26	21	8
7-10	18	20	28	26	8
10-12	21	24	31	28	7
2-5	4	12	19	11	7
5-8	12	19	26	19	7
8-10	19	21	28	26	7
1-3	0	10	10	0	0
3-6	10	16	16	10	0
6-9	16	20	20	16	0
9-11	20	25	25	20	0
11-12	25	31	31	25	0

b. Summary:

Activity	ES	EF	LF	LS	Slack
1	0	5	5	0	0
2	5	23	23	5	0
3	5	18	33	20	15
4	23	26	40	37	14
5	23	33	33	23	0
6	33	37	44	40	7
7	33	44	44	33	0
8	44	53	53	44	0
9	53	55	55	53	0

- 6. 30 weeks
- 7. b. 24 days: .9686; 21 days: .2350
 - c. 24 days: .9328; 21 days: .0186
 - d. Crash activities F, C, and G one day each

- 8. a. .6881
 - b. .3978
 - c. .0203
- 9. a. .3479
- 10. b. .52
- 11. b. .030
 - c. .2085

12. Path

Path	Mean	Standard Deviation
a-d-e-h	24.34	1.354
a-f-g	15.50	1.258
b-i-j-k	14.83	1.014
c-m-n-o	26.17	1.658

- 27 weeks: .6742; 26 weeks: .4099
- 14. Crash schedule (1 week each): C, C, F, F, E, P
- 15. a. Crash four weeks: (1) 7-11, (2) 1-2, (3) 7-11 and 6-10, (4) 11-13 and 4-6
- 17. a. 18.5 days
 - b. .67

CHAPTER 18: Management of Waiting Lines

- 1. a. (1) .60
 - (2) .90 customer
 - (3) .30 hr
- b. (1) 2.25 customers
 - (2) .75
 - (3) Two hours
 - (4) .5625
- c. (1) .75
 - (2) 3.429 customers
 - (3) .107 hr
- 2. a. 0.67 customer
 - b. One minute
 - c. 1.33 customers
- 3. a. 6 minutes
 - b. 0.25
 - c. 2.25 customers
- 4. a. Morning: 0.375 minute; .45
 - Afternoon: 0.678 minute; .54
 - Evening: 0.635 minute; .44
- b. M: 4; A: 8; E: 5
- 5. a. .45
 - b. .229
 - c. .509 hour
 - d. .28
- 6. a. 4.444 trucks
 - b. 6.67 minutes
 - c. .711
 - d. 6 minutes
 - e. The system would be overloaded.
 - f. 13.186
- 7. a. One dock
 - b. No

8. a. 0.952 mechanic
b. 0.228
c. 0.056 hr
d. 0.60
e. Two
9. a. 0.995 customer
b. 2.24 days
c. 19.9 percent
d. 0.875 customer
10. a. .437
b. 0.53 machine
c. 1.33 machines
d. 40.72 pieces
e. Three
11. a. 28.56 pieces
b. Two
12. a. 15.9 pieces
b. Three
13. Three
14. a. .90
b. $W_1 = .12$ hour
 $W_2 = .3045$ hour
 $W_3 = 2.13$ hours
c. $L_1 = .365$
 $L_2 = .914$
 $L_3 = 6.395$
15. a. .75
b. $L_1 = .643$
 $L_2 = 1.286$
18. a. approx. 0.0116
b. approx. 0.433
- CHAPTER 19: Linear Programming**
1. a. (1) $x_1 = 2, x_2 = 9, Z = 35$
(2) No
(3) No
(4) No
b. (1) $x_1 = 1.5, x_2 = 6.25, Z = 65.5$
(2) No
(3) Yes, S has surplus of 15
(4) No
c. (1) $A = 24, B = 20, Z = \$204$
(2) Yes. Labor, 120 hr
(3) No
(4) No
2. a. $S = 8, T = 20, Z = \$58.40$
b. (1) $x_1 = 4.2, x_2 = 1.6, Z = 13.2$
(2) Yes. $F = 4.6$
(3) No
(4) No
3. a. $H = 132$ units, $W = 36$ units, Profit = \$6,360
4. Deluxe = 90 bags, Standard = 60 bags, Profit = \$243
5. 500 apple, 200 grape, Revenue = \$2,970. Fifty cups of sugar will be unused.
6. a. $x_1 = 4, x_2 = 0, x_3 = 18$
 $s_1 = 3, s_2 = 0, s_3 = 0$
 $Z = 106$
b. $x_1 = 15, x_2 = 10, x_3 = 0$
 $s_1 = 0, s_2 = 0, s_3 = 5$
 $Z = 210$
9. $A = 0, B = 80, C = 50$
 $Z = 350$
 C_A (insignificance): \$ $-\infty$ to \$3.04
 C_B (optimality): \$1.95 to \$3.75
 C_C (optimality): \$2.00 to \$5.00
11. a. board = 0, holder = 50
b. Cutting = 16 minutes, gluing = 0 minutes, finishing = 210 minutes
12. a. Ham = 37.14, deli = 18, cost = \$165.42
b. Ham = 20, deli = 84, profit = \$376
14. $Z = \$433$
15. a. Machine and materials are binding.
b. No change
c. No change
d. Only s_2 would change. It would be 46.
e. None
f. Yes; \$844
16. a. \$1.50; range is 550 to 750
b. \$1.50/pound
c. \$0; range 375 to infinity
d. None
e. 150 pounds of pine bark
f. Optimal quantities would not change; Z would increase by \$75
g. No, Yes, \$1,155
h. No

B

Tables

- A. Areas under the normal curve, 0 to z
- B. Areas under the standardized normal curve
 1. From $-\infty$ to $-z$
 2. From $-\infty$ to $-z$
- C. Cumulative Poisson probabilities

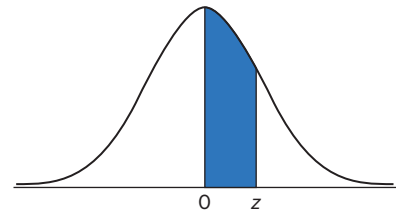

TABLE A Areas under the normal curve, 0 to z

z	.00	.01	.02	.03	.04	.05	.06	.07	.08	.09
0.0	.0000	.0040	.0080	.0120	.0160	.0199	.0239	.0279	.0319	.0359
0.1	.0398	.0438	.0478	.0517	.0557	.0596	.0636	.0675	.0714	.0753
0.2	.0793	.0832	.0871	.0910	.0948	.0987	.1026	.1064	.1103	.1141
0.3	.1179	.1217	.1255	.1293	.1331	.1368	.1406	.1443	.1480	.1517
0.4	.1554	.1591	.1628	.1664	.1700	.1736	.1772	.1808	.1844	.1879
0.5	.1915	.1950	.1985	.2019	.2054	.2088	.2123	.2157	.2190	.2224
0.6	.2257	.2291	.2324	.2357	.2389	.2422	.2454	.2486	.2517	.2549
0.7	.2580	.2611	.2642	.2673	.2703	.2734	.2764	.2794	.2823	.2852
0.8	.2881	.2910	.2939	.2967	.2995	.3023	.3051	.3078	.3106	.3133
0.9	.3159	.3186	.3212	.3238	.3264	.3289	.3315	.3340	.3365	.3389
1.0	.3413	.3438	.3461	.3485	.3508	.3531	.3554	.3577	.3599	.3621
1.1	.3643	.3665	.3686	.3708	.3729	.3749	.3770	.3790	.3810	.3830
1.2	.3849	.3869	.3888	.3907	.3925	.3944	.3962	.3980	.3997	.4015
1.3	.4032	.4049	.4066	.4082	.4099	.4115	.4131	.4147	.4162	.4177
1.4	.4192	.4207	.4222	.4236	.4251	.4265	.4279	.4292	.4306	.4319
1.5	.4332	.4345	.4357	.4370	.4382	.4394	.4406	.4418	.4429	.4441
1.6	.4452	.4463	.4474	.4484	.4495	.4505	.4515	.4525	.4535	.4545
1.7	.4554	.4564	.4573	.4582	.4591	.4599	.4608	.4616	.4625	.4633
1.8	.4641	.4649	.4656	.4664	.4671	.4678	.4686	.4693	.4699	.4706
1.9	.4713	.4719	.4726	.4732	.4738	.4744	.4750	.4756	.4761	.4767
2.0	.4772	.4778	.4783	.4788	.4793	.4798	.4803	.4808	.4812	.4817
2.1	.4821	.4826	.4830	.4834	.4838	.4842	.4846	.4850	.4854	.4857
2.2	.4861	.4864	.4868	.4871	.4875	.4878	.4881	.4884	.4887	.4890
2.3	.4893	.4896	.4898	.4901	.4904	.4906	.4909	.4911	.4913	.4916
2.4	.4918	.4920	.4922	.4925	.4927	.4929	.4931	.4932	.4934	.4936
2.5	.4938	.4940	.4941	.4943	.4945	.4946	.4948	.4949	.4951	.4952
2.6	.4953	.4955	.4956	.4957	.4959	.4960	.4961	.4962	.4963	.4964
2.7	.4965	.4966	.4967	.4968	.4969	.4970	.4971	.4972	.4973	.4974
2.8	.4974	.4975	.4976	.4977	.4977	.4978	.4979	.4979	.4980	.4981
2.9	.4981	.4982	.4982	.4983	.4984	.4984	.4985	.4985	.4986	.4986
3.0	.4987	.4987	.4987	.4988	.4988	.4989	.4989	.4989	.4990	.4990

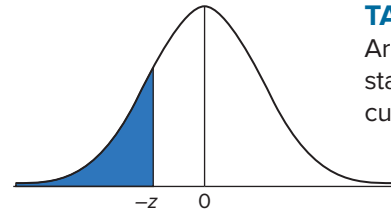

TABLE B.1
Areas under the standardized normal curve, from $-\infty$ to $-z$

.09	.08	.07	.06	.05	.04	.03	.02	.01	.00	z
.0002	.0003	.0003	.0003	.0003	.0003	.0003	.0003	.0003	.0003	-3.4
.0003	.0004	.0004	.0004	.0004	.0004	.0004	.0005	.0005	.0005	-3.3
.0005	.0005	.0005	.0006	.0006	.0006	.0006	.0006	.0007	.0007	-3.2
.0007	.0007	.0008	.0008	.0008	.0008	.0009	.0009	.0009	.0010	-3.1
.0010	.0010	.0011	.0011	.0011	.0012	.0012	.0013	.0013	.0013	-3.0
.0014	.0014	.0015	.0015	.0016	.0016	.0017	.0018	.0018	.0019	-2.9
.0019	.0020	.0021	.0021	.0022	.0023	.0023	.0024	.0025	.0026	-2.8
.0026	.0027	.0028	.0029	.0030	.0031	.0032	.0033	.0034	.0035	-2.7
.0036	.0037	.0038	.0039	.0040	.0041	.0043	.0044	.0045	.0047	-2.6
.0048	.0049	.0051	.0052	.0054	.0055	.0057	.0059	.0060	.0062	-2.5
.0064	.0066	.0068	.0069	.0071	.0073	.0075	.0078	.0080	.0082	-2.4
.0084	.0087	.0089	.0091	.0094	.0096	.0099	.0102	.0104	.0107	-2.3
.0110	.0113	.0116	.0119	.0122	.0125	.0129	.0132	.0136	.0139	-2.2
.0143	.0146	.0150	.0154	.0158	.0162	.0166	.0170	.0174	.0179	-2.1
.0183	.0188	.0192	.0197	.0202	.0207	.0212	.0217	.0222	.0228	-2.0
.0233	.0239	.0244	.0250	.0256	.0262	.0268	.0274	.0281	.0287	-1.9
.0294	.0301	.0307	.0314	.0322	.0329	.0336	.0344	.0351	.0359	-1.8
.0367	.0375	.0384	.0392	.0401	.0409	.0418	.0427	.0436	.0446	-1.7
.0455	.0465	.0475	.0485	.0495	.0505	.0516	.0526	.0537	.0548	-1.6
.0559	.0571	.0582	.0594	.0606	.0618	.0630	.0643	.0655	.0668	-1.5
.0681	.0694	.0708	.0721	.0735	.0749	.0764	.0778	.0793	.0808	-1.4
.0823	.0838	.0853	.0869	.0885	.0901	.0918	.0934	.0951	.0968	-1.3
.0985	.1003	.1020	.1038	.1056	.1075	.1093	.1112	.1131	.1151	-1.2
.1170	.1190	.1210	.1230	.1251	.1271	.1292	.1314	.1335	.1357	-1.1
.1379	.1401	.1423	.1446	.1469	.1492	.1515	.1539	.1562	.1587	-1.0
.1611	.1635	.1660	.1685	.1711	.1736	.1762	.1788	.1814	.1841	-0.9
.1867	.1894	.1922	.1949	.1977	.2005	.2033	.2061	.2090	.2119	-0.8
.2148	.2177	.2206	.2236	.2266	.2296	.2327	.2358	.2389	.2420	-0.7
.2451	.2483	.2514	.2546	.2578	.2611	.2643	.2676	.2709	.2743	-0.6
.2776	.2810	.2843	.2877	.2912	.2946	.2981	.3015	.3050	.3085	-0.5
.3121	.3156	.3192	.3228	.3264	.3300	.3336	.3372	.3409	.3446	-0.4
.3483	.3520	.3557	.3594	.3632	.3669	.3707	.3745	.3783	.3821	-0.3
.3859	.3897	.3936	.3974	.4013	.4052	.4090	.4129	.4168	.4207	-0.2
.4247	.4286	.4325	.4364	.4404	.4443	.4483	.4522	.4562	.4602	-0.1
.4641	.4681	.4721	.4761	.4801	.4840	.4880	.4920	.4960	.5000	-0.0

$$P(x \leq c) = \sum_{x=0}^{x=c} \frac{\mu^x \cdot e^{-\mu}}{x!}$$

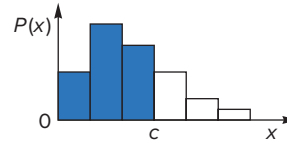

TABLE C
Cumulative Poisson probabilities

$\mu \backslash x$	0	1	2	3	4	5	6	7	8	9
0.05	.951	.999	1.000							
0.10	.905	.995	1.000							
0.15	.861	.990	.999	1.000						
0.20	.819	.982	.999	1.000						
0.25	.779	.974	.998	1.000						
0.30	.741	.963	.996	1.000						
0.35	.705	.951	.994	1.000						
0.40	.670	.938	.992	.999	1.000					
0.45	.638	.925	.989	.999	1.000					
0.50	.607	.910	.986	.998	1.000					
0.55	.577	.894	.982	.998	1.000					
0.60	.549	.878	.977	.997	1.000					
0.65	.522	.861	.972	.996	.999	1.000				
0.70	.497	.844	.966	.994	.999	1.000				
0.75	.472	.827	.960	.993	.999	1.000				
0.80	.449	.809	.953	.991	.999	1.000				
0.85	.427	.791	.945	.989	.998	1.000				
0.90	.407	.772	.937	.987	.998	1.000				
0.95	.387	.754	.929	.984	.997	1.000				
1.0	.368	.736	.920	.981	.996	.999	1.000			
1.1	.333	.699	.900	.974	.995	.999	1.000			
1.2	.301	.663	.880	.966	.992	.998	1.000			
1.3	.273	.627	.857	.957	.989	.998	1.000			
1.4	.247	.592	.833	.946	.986	.997	.999	1.000		
1.5	.223	.558	.809	.934	.981	.996	.999	1.000		
1.6	.202	.525	.783	.921	.976	.994	.999	1.000		
1.7	.183	.493	.757	.907	.970	.992	.998	1.000		
1.8	.165	.463	.731	.891	.964	.990	.997	.999	1.000	
1.9	.150	.434	.704	.875	.956	.987	.997	.999	1.000	
2.0	.135	.406	.677	.857	.947	.983	.995	.999	1.000	
2.2	.111	.355	.623	.819	.928	.975	.993	.998	1.000	
2.4	.091	.308	.570	.779	.904	.964	.988	.997	.999	1.000
2.6	.074	.267	.518	.736	.877	.951	.983	.995	.999	1.000
2.8	.061	.231	.470	.692	.848	.935	.976	.992	.998	.999

TABLE C (concluded)

$\mu \backslash x$	0	1	2	3	4	5	6	7	8	9	10	11	12	13	14	15	16	17	18	19	20	
3.0	.050	.199	.423	.647	.815	.916	.966	.988	.996	.999	1.000											
3.2	.041	.171	.380	.603	.781	.895	.955	.983	.994	.998	1.000											
3.4	.033	.147	.340	.558	.744	.871	.942	.977	.992	.997	.999	1.000										
3.6	.027	.126	.303	.515	.706	.844	.927	.969	.988	.996	.999	1.000										
3.8	.022	.107	.269	.474	.668	.816	.909	.960	.984	.994	.998	.999	1.000									
4.0	.018	.092	.238	.433	.629	.785	.889	.949	.979	.992	.997	.999	1.000									
4.2	.015	.078	.210	.395	.590	.753	.868	.936	.972	.989	.996	.999	1.000									
4.4	.012	.066	.185	.359	.551	.720	.844	.921	.964	.985	.994	.998	.999	1.000								
4.6	.010	.056	.163	.326	.513	.686	.818	.905	.955	.980	.992	.997	.999	1.000								
4.8	.008	.048	.143	.294	.476	.651	.791	.887	.944	.975	.990	.996	.999	1.000								
5.0	.007	.040	.125	.265	.441	.616	.762	.867	.932	.968	.986	.995	.998	.999	1.000							
5.2	.006	.034	.109	.238	.406	.581	.732	.845	.918	.960	.982	.993	.997	.999	1.000							
5.4	.005	.029	.095	.213	.373	.546	.702	.822	.903	.951	.978	.990	.996	.999	1.000							
5.6	.004	.024	.082	.191	.342	.512	.670	.797	.886	.941	.972	.988	.995	.998	.999	1.000						
5.8	.003	.021	.072	.170	.313	.478	.638	.771	.867	.929	.965	.984	.993	.997	.999	1.000						
6.0	.003	.017	.062	.151	.285	.446	.606	.744	.847	.916	.957	.980	.991	.996	.999	.999	1.000					
6.2	.002	.015	.054	.134	.259	.414	.574	.716	.826	.902	.949	.975	.989	.995	.998	.999	1.000					
6.4	.002	.012	.046	.119	.235	.384	.542	.687	.803	.886	.939	.969	.986	.994	.997	.999	1.000					
6.6	.001	.010	.040	.105	.213	.355	.511	.658	.780	.869	.927	.963	.982	.992	.997	.999	.999	1.000				
6.8	.001	.009	.034	.093	.192	.327	.480	.628	.755	.850	.915	.955	.978	.990	.996	.998	.999	1.000				
7.0	.001	.007	.030	.082	.173	.301	.450	.599	.729	.830	.901	.947	.973	.987	.994	.998	.999	1.000				
7.2	.001	.006	.025	.072	.156	.276	.420	.569	.703	.810	.887	.937	.967	.984	.993	.997	.999	.999	1.000			
7.4	.001	.005	.022	.063	.140	.253	.392	.539	.676	.788	.871	.926	.961	.980	.991	.996	.998	.999	1.000			
7.6	.001	.004	.019	.055	.125	.231	.365	.510	.648	.765	.854	.915	.954	.976	.989	.995	.998	.999	1.000			
7.8	.000	.004	.016	.048	.112	.210	.338	.481	.620	.741	.835	.902	.945	.971	.986	.993	.997	.999	1.000			
8.0	.000	.003	.014	.042	.100	.191	.313	.453	.593	.717	.816	.888	.936	.966	.983	.992	.996	.998	.999	1.000		
8.2	.000	.003	.012	.037	.089	.174	.290	.425	.566	.692	.796	.873	.926	.960	.979	.990	.995	.998	.999	1.000		
8.4	.000	.002	.010	.032	.079	.157	.267	.400	.537	.666	.774	.857	.915	.952	.975	.987	.994	.997	.999	1.000		
8.6	.000	.002	.009	.030	.070	.142	.246	.373	.509	.640	.752	.849	.909	.949	.973	.986	.993	.997	.999	1.000		
8.8	.000	.002	.007	.024	.062	.128	.226	.348	.482	.614	.729	.822	.889	.935	.964	.981	.990	.995	.998	.999	1.000	
9.0	.000	.001	.006	.021	.055	.116	.207	.324	.456	.587	.706	.803	.876	.926	.959	.978	.989	.995	.998	.999	1.000	
9.5	.000	.001	.004	.015	.040	.089	.165	.269	.392	.522	.645	.752	.836	.898	.940	.967	.982	.991	.996	.998	.999	

C

Working with the Normal Distribution

The normal distribution is a theoretical distribution that approximates many real-life phenomena. It is widely used in many disciplines, including operations management. Consequently, having the ability to work with normal distributions is a skill that will serve you well.

The normal curve is symmetrical and bell-shaped, as illustrated in Figure C.1. Although the theoretical distribution extends in both directions, to plus or minus infinity, most of the distribution lies close to its mean, so values of a variable that is normally distributed will occur relatively close to the distribution mean.

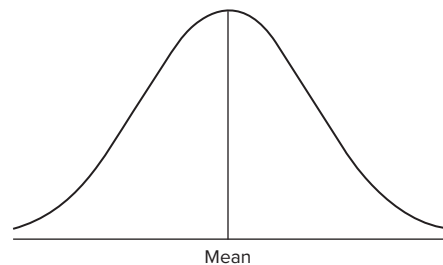

FIGURE C.1 The normal distribution

z Values

It is customary to refer to a value of a normally distributed random variable in terms of the number of standard deviations the value is from the mean of the distribution. This is known as its z value, or z score. In Figure C.2 you can see the normal distribution in terms of some selected z values. This particular distribution is referred to as the standard normal distribution. Notice that the z values to the left of (i.e., below) the mean are negative. Thus, a z value of -1.25 refers to a value that is 1.25 standard deviations below the distribution mean.

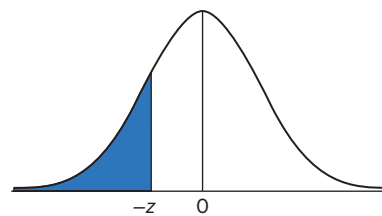

FIGURE C.2 The standard normal distribution with selected values of z

When working with a variable that is normally distributed, it is often necessary to convert an actual value of the variable to a z value. The z value can be computed using the following formula:

$$z = \frac{x - \mu}{\sigma}$$

where

x = A specified value of a variable

μ = The distribution mean

σ = The distribution standard deviation

A normal distribution has a mean of 20 and a standard deviation of 2. What is the z value of 17.5?

EXAMPLE 1

$$\begin{aligned}x &= 17.5 \\ \mu &= 20 \\ \sigma &= 2\end{aligned}$$

Using the formula for z we find:

$$\begin{aligned}z &= \frac{x - \mu}{\sigma} \\ z &= \frac{17.5 - 20}{2} = -1.25\end{aligned}$$

SOLUTION **z Values and Probabilities**

Once the z value is known, it can be used to obtain various probabilities by referring to a table of the normal distribution, such as the probability that a value will occur by chance that is greater than, or less than, that value. Note that the probability of *exactly* that value is zero, because there are an infinite number of values that could occur, so the probability of specifying in advance that any one particular value will occur is essentially equal to zero. z values can also be used to find the probability that a value will occur that is between $\pm z$. Two such cases are shown in Figure C.3. Note that the total area underneath the curve represents 100 percent of the probability, so knowing that the probability that a value will occur that is within the range, say, of $z = \pm 2$ is .9544, we can say that the probability that a value will occur that is outside of the range (e.g., either less than $z = -2$ or greater than $z = +2$) is equal to $1.0000 - .9544 = .0456$.

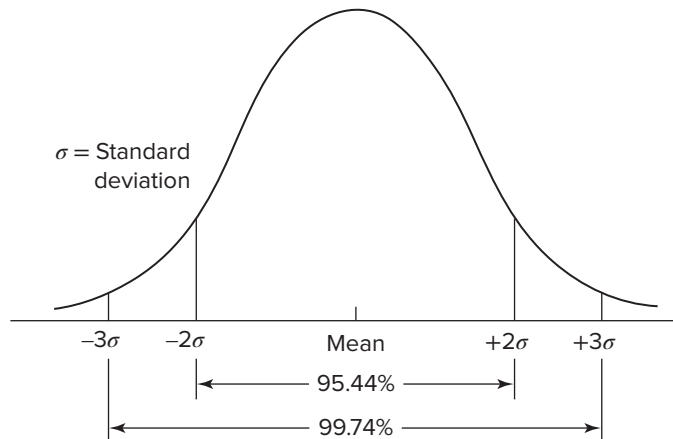

FIGURE C.3 Areas under the normal curve between $z = \pm 2\sigma$ and $z = \pm 3\sigma$

Tables of the Normal Distribution

Virtually all applications of the normal distribution involve working with a table of normal distribution probabilities. Tables make the process of obtaining probabilities and z values quite simple. This book has two slightly different normal distribution tables. Appendix B Table A has values for the right half of the distribution for the area under the curve (note the figure at the top of the table), which is the probability from the mean of the distribution ($z = 0$) to any other value of z , up to $z = +3.09$. Statistics books always have this version of the table, so you may already be familiar with it. A second table of normal probabilities is presented in Appendix B Tables B1 and B2. They show the area under the curve from negative infinity to any point z (see the figure at the top of the table), up to $z = +3.49$. In both tables, the values of z are shown in two parts. The integer and first decimal are shown along the side of the table, while the second decimal is shown across the top.

EXAMPLE 2

Using Appendix B Table B.2, find the area under the curve to the left of $z = 1.12$.

SOLUTION

$z = 1.12$ becomes 1.1
 .02
 1.12

Find the row where $z = 1.1$ down the left-hand side of the table. Find the .02 column across the top of the table. The probability is at the intersection of the 1.1 row and the .02 column.

z	.00	.01	.02	.03	.04	.05	.06	.07	.08	.09
.0	.5000	.5040	.5080	.5120	.5160	.5199	.5239	.5279	.5319	.5359
.1	.5398	.5438	.5478	.5517	.5557	.5596	.5636	.5675	.5714	.5753
.2	.5793	.5832	.5871	.5910	.5948	.5987	.6026	.6064	.6103	.6141
.3	.6179	.6217	.6255	.6293	.6331	.6368	.6406	.6443	.6480	.6517
.4	.6554	.6591	.6628	.6664	.6700	.6736	.6772	.6808	.6844	.6879
.5	.6915	.6950	.6985	.7019	.7054	.7088	.7123	.7157	.7190	.7224
.6	.7257	.7291	.7324	.7357	.7389	.7422	.7454	.7486	.7517	.7549
.7	.7580	.7611	.7642	.7673	.7703	.7734	.7764	.7794	.7823	.7852
.8	.7881	.7910	.7939	.7967	.7995	.8023	.8051	.8078	.8106	.8133
.9	.8159	.8186	.8212	.8238	.8264	.8289	.8315	.8340	.8365	.8389
1.0	.8413	.8438	.8461	.8485	.8508	.8531	.8554	.8577	.8599	.8621
1.1	.8643	.8665	.8686	.8708	.8729	.8749	.8770	.8790	.8810	.8830
1.2	.8849	.8869	.8888	.8907	.8925	.8944	.8962	.8980	.8997	.9015
1.3	.9032	.9049	.9066	.9082	.9099	.9115	.9131	.9147	.9162	.9177
1.4	.9192	.9207	.9222	.9236	.9251	.9265	.9279	.9292	.9306	.9319

Note: You will find versions of both tables at the very end of the book for easy reference. The last table repeats Appendix B Table A. The other table repeats Appendix B Table B.2., the positive values of z . For problems that involve negative values of z , refer to the portion of Appendix B Table B.1.

Finding a Probability of Observing a Value That Is Within $\pm z$ of the Mean or Outside of $\pm z$

Use Appendix B Table A for this type of problem:

EXAMPLE 3

Find the area under the curve that is *within* two standard deviations of the mean.

SOLUTION

What the problems is asking for:

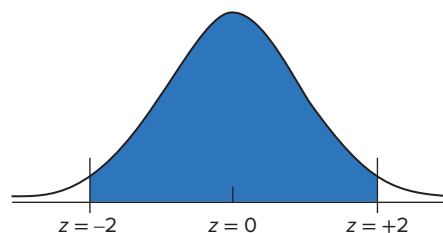

Appendix B Table A provides the right half of the area:

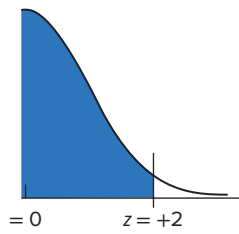

The shaded area is .4772.

To find the total area between $\pm z = 2$, double the amount in the right half: $2(.4772) = .9544$.

Find the area under the curve that is *outside* of two standard deviations from the mean.

EXAMPLE 4

What the problem is asking for:

SOLUTION

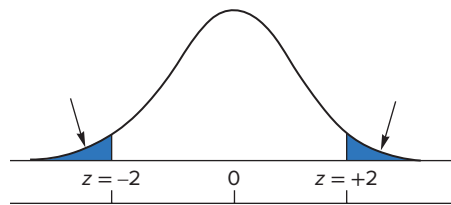

Appendix B Table A provides the right half of the area between the mean and $z = +2$. To find the area in the right tail, subtract the amount between the mean and $z = +2$ from .5000:

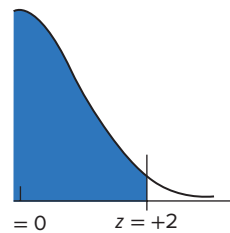

Area under the right side of the curve: .5000
 Subtract the area from $z = 0$ to $z = +2.00$: $-.4772$
 The area to the right of $z = +2.00$ is: .0228

The same amount will be in each tail, so the total area in both tails is $2(.0228) = .0456$.

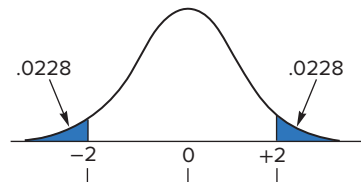

Another way to arrive at the same answer is to note that the area within two standard deviations of the mean is .9544, as shown previously, so the area outside of that is $1.0000 - .9544 = .0456$.

Finding an Area (Probability) That Is to the Left or to the Right of z

Use Appendix B Table B.2 for this type of problem (e.g., “What is the probability that the time will not exceed 22 weeks?”).

EXAMPLE 5

A normal distribution has a mean of 20 and a standard deviation of 1.0. Find the probabilities:

- A value that is 22 or less.
- A value that is 22 or more.

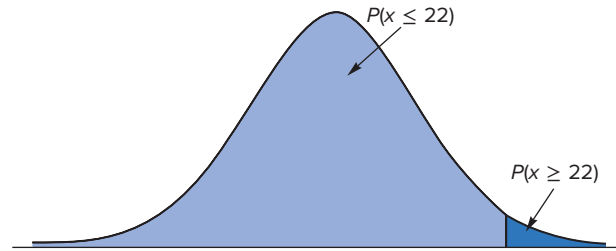
**SOLUTION**

First, determine the value of z for 22:

$$z = \frac{x - \mu}{\sigma} = \frac{22 - 20}{1} = +2.00$$

- From Appendix B Table B, the area (probability) to the left of $z = +2.00$ is .9772.
- Because the total area under the curve is 100 percent, or 1.0000, the area to the right of $z = +2.00$ is simply $1.0000 - .9772 = .0228$.

Points to Remember

- The area under a normal curve represents probability.
- The area under the curve is 100 percent, or 1.0000.
- The area on either side of the mean is equal to half of the total, which is 50 percent, or .5000.
- The curve extends to \pm infinity, but 99.74 percent of the values will occur within ± 3 standard deviations of the mean.
- It is best to use Appendix B Table A for problems involving $\pm z$ (i.e., Chapters 7 and 10), and to use Appendix B Table B for problems involving one-sided probabilities such as the probability that x will be no more than a given (i.e., Chapters 4S, 13, and 17).
- The probability of an exact value (e.g., 22 in Example 5) is zero. Therefore, $P(x \leq 22) = P(x < 22)$.

Test Yourself

- Suppose a normal distribution has a mean of 40 and a standard deviation of 5. Find the value of z for each of these values:
 - 48
 - 30
 - 34
 - 52.5
- Using Appendix B Table A, find the area between $\pm z$ when z is:
 - 1.00
 - 1.96
 - 2.10
 - 2.50
- Find the probability of observing a value that is beyond $\pm z$ when z is:
 - 1.00
 - 1.80
 - 1.88
 - 2.54
- Use the appropriate Appendix B Table to find the probability of a value that does not exceed a z value of:
 - .40
 - 1.27
 - 1.32
 - 2.75
- Find the probability of observing a value that is more than a z value of:
 - .77
 - 1.65
 - 1.32
 - 2.75

Answers

- +1.60
 - 2.00
 - 1.20
 - +2.50
- .6826
 - .9500
 - .9642
 - .9876
- .3174
 - .0718
 - .0602
 - .0110
- .6554
 - .8980
 - .0934
 - .9970
- .2206
 - .0495
 - .9066
 - .0030

D

Ten Things to Remember Beyond the Final Exam

1. The way work is organized (i.e., project, job shop, batch, assembly, or continuous) has significant implications for the entire organization, including the type of work that is done, forecasting, layout, equipment selection, equipment maintenance, accounting, marketing, purchasing, inventory control, material handling, scheduling, and more.
2. Pay attention to variability, and reduce it whenever you can. Variability causes problems for management, whether it is variability in demand (capacity planning, forecasting, and inventory management), variability in deliveries from suppliers (inventory management, operations, order fulfillment), or variability in production or service rates (operations planning and control). Any of these can adversely affect customer satisfaction and costs. Recognize this, and build an appropriate amount of flexibility into systems.
3. “Homework is on the Highway to Happiness.” This relates not only to coursework, but also to your career: Be prepared for interviews, meetings, conferences, presentations (yours and others’), and other events. You can achieve a great deal of success by simply “doing your homework.”
4. How managers relate to subordinates can have a tremendous influence on the success or lack of success of an organization. Selection, training, motivation, and support are all important. One philosophy is: “Choose the right people, give them the tools they need, and then stay out of their way.”
5. Quality and price will always be prominent factors in consumers’ buying decisions. Strive to integrate quality in every aspect of what you do, and to reduce costs.
6. Pay careful attention to technology; consider both the opportunities and the risks. Opportunities: improvements in quality, service, and response time. Risks: technology can be costly, difficult to integrate, needs to be periodically updated (for additional cost), requires training, and quality and service may temporarily suffer when new technology is introduced.
7. Pay attention to capacity; the roads to success and failure both run through capacity.
8. Never underestimate your competitors. Assume they will always make the best decisions.
9. Most decisions involve trade-offs. Understand the trade-offs.
10. Make ethics a part of everything you do.

Company Index

- Abt Electronics, 387
Adobe Systems, 30
Alibaba, 355
Allen-Bradley, 256–257
Amazon.com, 44, 45, 47, 351, 473, 670, 684, 787
Apple, 47, 56, 181, 254, 360, 396
- Barnesandnoble.com, 670
Bayer AG, 353
Bell Atlantic, 26
Bell Telephone Laboratories, 23, 380
Bethlehem Steel Company, 311
Blue Bottle Coffee, 355
BMW, 280, 353
Boeing Company, 145, 644, 675
Bose Corporation, 638
Boston Market, 49
Bruegger's Bagel Bakery, 556
Buffalo Wild Wings, 155
Burger King, 47, 155, 262, 468
- Chacarero, 484
Chrysler, 114
Coach, 47
Coca-Cola, 47, 353
Compaq Computer, 47
Consumer Reports, 181, 649
Costco, 31
- Deaconess Clinic (Montana), 221
Dell Computers, 50, 155, 254, 675
Deloitte, 659
Deloitte Consulting, 586
Deloitte Touche Tohmatsu, 357–358
Disneyland, 47, 644
Disney World, 77, 785, 815
Domino's Pizza, 47, 637
Doordash, 661
- eBay, 31
EOG Resources, 62
Express Mail, 47, 637
- Federated Department Stores, 671
FedEx, 47, 71, 637, 661, 670
Fingerhut, 671
Firestone Tire & Rubber, 144
Ford Motor Company, 22, 30, 144, 257, 614
Foxconn, 254
Fuddruckers, 202
- Gap, 26, 30, 75
Gartner, 740
General Mills, 619
General Motors (GM), 144, 504, 612, 621, 623
Globe Metallurgical, 391
Google, 47, 309, 764
Grubhub, 47, 661
- Happy Returns, 684
Hershey's, 28
Hewlett-Packard (HP), 47, 113, 143, 154, 165, 254, 408
High Acres Landfill (New York), 174
- H.J. Heinz Company, 148
H&M, 26
Hoechst AG, 353
Home Depot, 75
Humantech Inc., 302
Hyundai Motor Company, 57, 389
- IBM, 24, 47, 113, 143, 660
Intel, 17, 30
- JCPenney, 75
Jersey Jack Pinball, 262
John Deere, 613
- Kentucky Fried Chicken (KFC), 386
Kraft Foods Company, 148
Kraft Heinz Company, 148
- Land O'Lakes, 202
LEGO A/S, 151, 152
Lexus, 47, 466
LG, 47
Liberty Resources, 62
L.L. Bean, 395
L'Oreal, 31
Louis Vuitton, 619
Luckin Coffee, 355
Lyft, 47
- Macy's, 26
Maria's Market, 150–151
Martin Company, 380
MasterTag, 689
Mattel Inc., 393, 424
McDonald's, 47, 49, 51, 146, 262, 270, 281, 355, 433, 468
Mercedes, 353
Meta Group, 584
Michigan International Speedway, 304
Microsoft, 30, 44, 193, 281, 734
Milliken & Company, 391
Minneapolis-St. Paul International Airport, 260
Mondelez, 148
Morton International, 250–251
Motorola Corporation, 391, 400, 446
MVP Services Group, Inc., 271
- NASCAR, 619
Nestlé, 355
Netflix, 351
Nissan, 353
Nordstrom, 47
NUMMI (New United Motor Manufacturing), Inc., 612
- Omron Electronics, 427
- Paychex, 30
PeopleSoft, 581
PepsiCo, 47
Perkins, 202
Pizza Hut, 386
PMI, 424
PSC, Inc., 557–559
- Puma, 28
- Queen Mary 2, 265
- Ryder, 513
- Safeway, 31
Sam's Club, 787
Samsung, 47
SAP, 581
Sara Lee, 202
7-11, 787
Sherwin-Williams, 142
Siemens AG, 353
Soletron, 196
Sony, 47
Southwest Airlines, 47
SpaceX, 424
Sperry Univac, 24
Springdale Farm, 680
Starbucks, 30, 44, 355
Steelcase, Inc., 140
Stickley Furniture, 606–609
Stockpot Soup Company, 202
Stryker Howmedica, 62
- Target, 31
Texas Instruments, 30
Third Eye, 510
3M, 47, 662
Tmsuk, 256
Toyota Company, 24, 47, 382, 421, 466, 611, 612, 613–615, 618, 635
Trek Bicycle Company, 16
Tri-State Industries, 627
- Uber, 47
UberEats, 355
Union Carbide, 26
U.S. Postal Service (USPS), 47, 70–73, 637
UPS, 31, 47, 71, 258, 311, 661, 670, 679
- Vaak, 510
Verizon, 44
Vlasic Pickles, 143
Von Maur, 47
VX Corporation, 566
- Walmart, 46, 47, 354, 377, 660, 661, 670
Walt Disney World, 77, 785, 815
Wegmans Food Markets, Inc., 31, 33–35, 47, 655, 677–678
Wendy's, 155, 468
Western Electric, 23
Whole Foods, 31
- Xerox Corporation, 30, 391
- YouTube, 24
- Zara, 26
Zipline, 258

Subject Index

- A-B-C approach, 510–513
Acceptance sampling, 419, 420
Accidents, 307–308
Accounting function
 collaboration with operations, 12
 ERP and, 582, 584
 forecasting in, 76
 interface with purchasing, 667
 in lean operations, 624
Activities, on network diagrams, 743
Activity-based costing, 624
Activity-on-arrow (AOA), 743, 744–750
Activity-on-node (AON), 743, 750–752
Actual output, 195
Additive manufacturing (3D printing), 257–259
Additive model, 94
Advertising, competitiveness and, 42
Africa
 “Cocoa for Good” initiative, 28
 drones in health care, 258
Aggregate planning, 465–501
 case, 501
 concept of aggregation, 468
 defined, 465
 demand management strategies, 201, 467–476, 484–485, 492, 656
 disaggregating the aggregate plan, 485–486
 general procedure, 476
 inputs and outputs, 469, 470
 master production schedule (MPS), 467, 486–491, 563
 mathematical techniques, 480–483
 need for, 468
 overview, 469, 492
 in perspective, 466–467
 in services, 484–485
 and supply chain, 470
 supply chain management strategies, 468–469, 471–476, 492
 trial-and-error technique, 476–480
 variations in, 465–466, 468–469
Agility, 26
 competitive edge and, 26
 in strategic capacity planning, 213
 strategy based on, 50, 53
 in supply chain management, 659, 665, 679
Airlines
 airport layout, 260, 271
 capacity planning, 484, 485
 duplicate orders, 469, 470
 product design, 145
 scheduling, 693, 716, 719
 scope of operations management, 14–15
Air pollution
 nonvegetarian diets and, 29
 recycling and, 149
Alderman, Richard M., 181
Allison-Koerber, Deborah, 112n
American Society for Quality (ASQ), 12, 13, 380, 393
Analytics, 20
Andon, 623
Anticipation stocks, 505
APICS, the Association for Operations Management, 12, 13, 513
Applied research, 143
Appointment systems, 716
Appraisal costs, 389, 390
Armony, Mor, 470n
Arrival patterns, 790–792
Arrival rate, 795
Artificial intelligence (AI)
 blockchain technology, 660–661
 in project management, 740
 in shoplifting prevention, 510
Assembled products. *See* Material requirements planning (MRP)
Assemble-to-order (ATO), 675
Assembly (repetitive processing). *See* Repetitive/assembly processing
Assembly diagrams, 563–564
Assembly lines. *See also* Repetitive/assembly processing
 defined, 261
 line balancing, 272–280
 moving, origins of, 22
Assignable (nonrandom) variation, 14, 425, 439, 441–442, 443
Assignment model, 701–704
Associative models, 80, 98–104
 multiple regression, 102, 104
 nonlinear regression, 104
 predictor variables, 98
 simple linear regression, 80, 98–104
Attributes
 defined, 430
 statistical process control (SPC), 434–437, 438
Audits, supplier, 671–672
Automation, 253–257
 advantages/disadvantages, 253–254
 in global operations, 354–355
 Internet of Things (IoT), 257
 in services, 270, 271–272
 types, 253–257
Automotive industry
 aggregate planning, 466
 capacity planning, 192
 component commonality, 165, 170
 extended warranties, 181
 flexible processes, 257
 forecasting demand in, 75
 global operations, 353
 inventory management, 504
 lean operations, 611–615, 630–631, 635
 location decisions, 353, 359
 mass production, 22
 product design, 142
 production/assembly lines, 261, 272–280
 product recall (case), 347
 quality management, 382, 384–385, 389, 421
 self-driving vehicles, 259
 specialization in, 302
Autonomation, 613, 619
Autonomous vehicles, 259
Availability, 183
 as reliability, 183–184
 in strategic capacity planning, 194
Available-to-promise (ATP) inventory, 488–491
Average number of customers, 794
Average number of customers being served, 794
Averaging techniques, 84–88
 exponential smoothing, 87–88, 112
 moving average, 84–86, 112
 weighted moving average, 86–87
Avoidance, 684
Awad, Elias M., 314n
Awards
 Deming Prize, 381, 391–392
 European Quality Award, 391
 International Design Excellence Award, 152
 Malcolm Baldrige National Quality Award, 388, 391
Baatz, E., 583–587
Bacal, Robert, 305, 305n
Backflushing, 576
Back orders/backlogging, in aggregate planning, 471, 474–475
Backward pass, 749, 752
Backward scheduling, 699
Balance delay, 275–276
Balanced Scorecard (BSC), 54–56
Balancing transactions, 631
Baldrige Award, 388, 391
Bar coding, 508–509
Bartlett, Christopher A., 51n
Basic quality (Kano model), 161–162
Basic research, 143
Batch processing, 67, 247, 248, 249, 715. *See also* Material requirements planning (MRP)
Behavioral issues
 job design, 302, 303
 project management, 739
 psychology of waiting, 813–814
Benchmarking, 395, 408
Berry, Leonard L., 384n, 385n
Berry, William L., 615n
Berthiaume, Dan, 660n
Beta distribution, 753–754
Bias, 109
Bill of materials (BOM), 563–566
Binding constraints, 839
Blockchain technology, 659–661
Block picking, 677
Bonuses, 309
Bottleneck operations, 203, 213, 714–715, 813
Bounded rationality, 224
Brainstorming, 407
Branches, decision tree, 228–229
Branding, 6
Breakdown maintenance, 647
 breakdown programs, 650
 high-volume system scheduling, 696
 preventive maintenance vs., 648–649
Break-even point (BEP), 208–211
Brice, Virginia, 89n
Budgeting, 10, 468. *See also* Aggregate planning

- learning curves in, 341
- in project management, 739, 759
- Buffers
 - in critical chain project management (CCPM), 763
 - inventory as, 506, 650, 674–675
- Bullwhip effect, 674–675
- Business organizations
 - collaboration among functional areas, 10–12
 - key component of, 139
 - key functional areas, 4, 10–12
 - reasons for failure, 43–44
 - uses of forecasting, 76–78. *See also* Forecasting
- Business plans, 467
- Business process management (BPM), 13
- Business-to-business (B2B) commerce, 671
- Caldwell, Phillip, 614
- Capability index, 445–446, 447
- Capacity
 - challenges of planning service capacity, 200–201
 - defined, 191
 - defining and measuring, 194–195
 - determinants of effective, 196–197
 - forecasting capacity requirements, 198–200
 - strategy formulation for, 197–198
- Capacity (resource) buffers, 763
- Capacity “chunks,” 204
- Capacity contraction, 213
- Capacity cushion, 198, 213
- Capacity disposal strategies, 213
- Capacity expansion
 - capacity planning in, 206, 213
 - expand-early strategy, 213
 - wait-and-see strategy, 213
- Capacity planning
 - intermediate-term decisions. *See* Aggregate planning
 - learning curves in, 341–342
 - long-term decisions. *See* Strategic capacity planning
 - master scheduling, 486–491
 - in service organizations, 14, 167, 200–201, 484–485
 - short-term decisions, 486–491
 - in supply chain management, 32, 666
 - time horizons in, 198–199, 200, 204–205, 466–467
 - waiting line. *See* Waiting-line management
- Capacity requirements planning, 579–581
- Capacity utilization, 195
- Capital productivity, 58
- Career opportunities
 - operations management, 12
 - professional associations, 12–13
- Carrying cost. *See* Holding (carrying) cost
- Case picking, 677
- Cases
 - Big Bank, 822
 - Chick-n-Gravy Dinner Line, 414
 - Custom Cabinets, Inc., 854–855
 - DMD Enterprises, 606
 - Eight Glasses a Day (EGAD), 501
 - Farmers Restaurant, 554–555
 - Girlfriend Collective, 69–70
 - Grill Rite, 554
 - Hazel, 38, 68
 - Hello, Walmart?, 377
 - Highline Financial Services, Ltd., 137
 - Hi-Ho, Yo-Yo, Inc., 731
 - Home-Style Cookies, 67–68
 - Level Operations, 643
 - MasterTag, 689
 - M&L Manufacturing, 136
 - Outsourcing of Hospital Services, 221
 - Product Recall, 347
 - Promotional Novelties, 605
 - Son, Ltd., 853–854
 - Tiger Tools, 462–463
 - Time, Please, 781
 - Tip Top Markets, 415–416
 - Toys, Inc., 462
 - UPD Manufacturing, 553
 - “Your Garden Gloves,” 69
- Cash flow, 211–212
- Causal regression models, 102, 112
- Causal (explanatory) variables, 80
- Cause-and-effect (fishbone) diagrams, 383, 402, 405, 406
- c*-charts, 434, 435, 436–437
- Cells, 266
- Cellular production, 266–268
- Centered moving average (MA), 96, 98
- Center-of-gravity method, 368–370
- Centralized purchasing, 668–669
- Central limit theorem, 426
- Certainty, 212
 - decision making under, 224–225
 - defined, 224
- Certification
 - fair trade, 30, 31
 - of project managers, 740
 - in quality management, 392–393, 672
 - of suppliers, 672
- Champions, 395, 400, 740
- Changeover time, in lean operations, 618–619
- Changes, in MRP, 574
- Change transactions, 631
- Channels (servers), 789–790, 800–801
- Chase demand strategy
 - in aggregate planning, 473–476, 492
 - defined, 474
- Chasen, Emily, 28n
- Cheaper by the Dozen* (film), 23
- Check sheets, 401–403, 406
- Cheng, Andrew, 355n
- China
 - fast-food restaurants, 386
 - outsourcing to, 659
 - quality management, 393, 424
 - recycling and, 149
 - Starbucks in, 355
- CIA (Central Intelligence Agency), 358
- Cleveland, Will, 424
- “Clicks-or-bricks” model, 683
- Climate, in location decisions, 359
- Closed-loop MRP, 578
- Closed-loop supply chain, 685
- Closeness ratings, 284–285
- Closing phase (project life cycle), 735, 736
- Clothing industry
 - agility in, 26
 - Girlfriend Collective, 69–70
 - outsourcing to China, 659
- Clustering, 363
- “Cocoa for Good” initiative, 28
- Collaborative planning, forecasting, and replenishment (CPFR), 674
- Collaborative robots (cobots), 255
- Combination layouts, 265–268
- Comfort band, 306
- Common Good Principle, 29
- Common variability, 425
- Community identification, in location decision, 359–360, 361
- Compensation, 308–310
 - knowledge-based pay systems, 310
 - management, 310
 - output-based (incentive) systems, 308–310
 - for producing goods vs. providing services, 9, 10
 - productivity and, 61
 - recent trends, 310
 - time-based systems, 308–309, 310
- Competitive edge, 46
- Competitiveness, 41, 42–44
 - capacity planning and, 193
 - competition as external factor, 48
 - as key issue in operations, 27
 - marketing influences on, 42
 - operations influences on, 42–43
 - process selection and, 256–257
 - productivity and, 42, 59
 - product/service design and, 140–143, 145
 - reasons organizations fail, 43–44
 - in supply chain management, 31, 43
 - of U.S. Postal Service (USPS), 71–72
- Complementary demand patterns, 205
- Complements, 337
- Component commonality, 165, 170
- Computer-aided design (CAD), 164–165, 170
- Computer-aided manufacturing (CAM), 254–255
- Computer-integrated manufacturing (CIM), 256–257
- Computerized numerical control (CNC), 254–255
- Computer software
 - enterprise resource planning (ERP), 581, 582–583, 586
 - forecasting, 113
 - linear programming, 840–843
 - project management, 764, 765
 - waiting-line, 785
- Concurrent engineering, 163–164, 617
- Constant percentage, learning curve, 337
- Constant work-in-process (CONWIP), 629
- Constraints
 - binding, 839
 - defined, 207, 826
 - linear programming, 826, 830–833, 836–837, 839
 - redundant, 836–837
 - sensitivity analysis, 844–846
 - in strategic capacity planning, 207
 - theory of constraints, 715, 763
 - in waiting-line management, 813
- Construction industry, modular design, 155
- Consumer Product Safety Commission (CPSC), 393
- Consumer surveys, 81
- Continuous improvement, 61, 382, 383, 394, 398–400, 420
 - defined, 395
 - in lean operations, 612, 616, 623–624
- Continuous processing, 247, 248, 249, 250–251

- Continuous review system, 507–508
 Contribution margin, 208
 Control, transformation process, 6
 Control charts
 defined, 107, 404, 428
 forecasting error and, 107–108, 111
 formula summary, 449
 as graphical quality tools, 402, 404–405, 407
 in statistical process control (SPC), 428–438, 442
 Control limits, 428–429
 forecasting error, 108–111
 process capability and, 443–444
 statistical process control (SPC), 428–429, 430–431, 434–437
 Controlling phase (project life cycle), 735, 736
 Conversion system, 6
 Conveyance *kanban* (c-kanban), 627
 Corbett, James J., 658n
 Core competencies, 46
 Corporate culture
 conversion to lean systems and, 636
 in lean operations, 612, 636
 TQM vs. traditional organizations, 396
 Correlation, 102
 Cost-benefit analysis, 161
 Costs
 of buying vs. making, 201
 of enterprise resource planning (ERP), 584–586
 global operations and, 352–353
 inventory, 506–507, 509–510, 526–527
 of over- and undercapacity, 13–14, 192, 193–194, 200, 213
 of quality, 382, 389–390
 Cost strategy, 44, 46, 47
 Cost-volume analysis, 208–211
 break-even point (BEP), 208–211
 indifference point, 209
 locational cost-profit-volume analysis, 364–366
 Council of Supply Chain Management Professionals (CSCMP), 13, 681
 Council on Competitiveness, 357–358
 Country identification, in location decisions, 357–358
 CPM (critical path method), 742–745. *See also* Network (precedence) diagrams
 Cradle-to-grave assessment, 146–147
 Craft production, 21
 Crashing, 759–762
 “Creeping featurism,” 145
 Critical activities, 744, 759–762
 Critical chain project management (CCPM), 763
 Critical path, 744, 745–746, 759–762
 Critical ratio (CR) priority rule, 704, 708–709, 710
 Crosby, Philip B., 382, 383, 390
 Cross-distribution, 677
 Cross-docking, 660, 677, 685
 Cross-training workers, 280, 623
 CR (critical ratio) priority rule, 704, 708–709, 710
 Cultural factors. *See also* Corporate culture
 for global operations, 354, 355
 in product/service design, 145–146
 Cumulative lead time, 563
 Currency risk, in location decisions, 358
 Customer contact, for goods vs. services, 9, 10
 Customers
 expectations for quality, 383–385, 389
 as external factor, 48
 Customer satisfaction, 26
 at Amazon.com, 45
 competitiveness and, 42
 Kano model and, 160–162
 in product/service design, 141, 142, 158–162, 167, 170
 in quality function deployment (QFD), 158–160
 at Wegmans Food Markets, Inc., 35
 Customer service
 inventory management in, 506–507
 quality and, 388
 strategy based on, 45, 47
 Customization, 20
 mass customization, 154–156, 170, 248
 Cyber-security, as key issue in operations, 27
 Cycle counting, 513
 Cycles
 defined, 82
 in forecasting, 82, 83, 98
 Cycle stock, 525
 Cycle time, 273–274, 276, 277–279
 Little’s Law, 506, 629
 Cyclical scheduling, 717–718
 Dantzig, George, 24
 Decentralized purchasing, 668–669
 Decision making, 18–20
 analysis of trade-offs, 19–20
 capacity decisions as strategic decisions, 193–194
 decision theory in. *See* Decision theory
 decision types, 16, 18, 33
 degree of customization, 20
 ethical, 29–31
 forecasts in. *See* Forecasting
 hierarchy of, 693–694
 models, 18–19, 23
 operational decisions, 16, 33, 44
 by operations manager, 16, 18–20, 223–224
 performance metrics, 19
 priorities in, 20
 in project management, 737–738
 qualitative approaches, 19
 quantitative approaches, 19, 23
 strategic decisions. *See* Strategic decisions
 in supply chain management, 33
 systems perspective, 20
 tactical decisions, 44
 under uncertainty, 224, 225–227
 Decision Sciences Institute, 13
 Decision tables, 536–537
 Decision theory, 222–243. *See also* Decision making
 causes of poor decisions, 223–224
 decision environments, 224–227
 decision trees, 227–229
 elements, 222
 expected value of perfect information (EVPI), 229–230
 payoff table, 223
 sensitivity analysis, 230–232
 steps in decision process, 222, 223
 in strategic capacity planning, 212
 Decision trees, 227–229
 Decision variables (linear programming), 826
 Decline phase of life cycle, 203
 Defects, as waste in lean operations, 616
 Delayed differentiation, 154, 468, 685–686
 Delivery speed, 193
 Dell, Michael, 50
 Delphi method, 81
 Demand. *See also* Strategic capacity planning
 in aggregate planning, 201, 467–476, 484–485, 492, 656
 complementary patterns, 205
 economic match with supply, 4, 76
 forecasting, 75–78, 114–115, 165, 198–199, 505–507, 509, 537. *See also* Forecasting
 inventory management and, 505, 507, 509, 537. *See also* Inventory management
 in lean operations, 612, 626–627
 process management to meet, 13–14
 in product/service design, 141
 for services, 484–485
 shifting, 813
 structural variation in, 14
 variability of, 167, 201, 205
 Demand chains, 656
 Demand management strategies, 201, 467–476, 484–485, 492, 556
 Deming, W. Edwards, 23–24, 381–382, 381n, 383, 391–392, 425
 Deming Prize, 381, 391–392
 Deming wheel, 398–399
 Demographic conditions, in product/service design, 141
 Dependent demand/dependent-demand items, 504, 561, 574, 575. *See also* Material requirements planning (MRP)
 Depth skills, 310
 Design. *See* Product/service design
 Design capacity, 194–195
 Design for assembly (DFA), 165
 Design for disassembly (DFD), 149
 Design for manufacturing (DFM), 165
 Design for recycling (DFR), 149
 Design review, in product design and development, 163
 Deterministic time estimates, 745–746
 Dettmer, H. William, 207
 Development, 143
 Differentiation strategy, 44, 47
 Diffusion models, 89
 Digital Millennium Copyright Act (1998), 142
 Direct numerical control (DNC), 254–255
 Discounts, quantity, 506, 520–525, 539
 Diseconomies of scale, 205–206
 Disintermediation, 686
 Disruption elimination, in lean operations, 615
 Distribution function
 operations management and, 16, 582
 strategy in supply chain management, 666
 Distribution resource planning (DRP), 580–581
 Division of labor, 23
 DMAIC (define-measure-analyze-improve-control), 400
 Dodge, H. F., 23, 24, 380
 Doubling effect, learning curve, 337–338
 Drones, 258, 259, 513
 Drum-buffer-rope conceptualization, 714–715
 Du, Lisa, 510n
 Dummy activity, 744
 Dynamic line balancing, 280

- Earliest due date (EDD) priority rule, 704, 707, 709, 710
- E-business, 24–25, 670–671
 business-to-business (B2B) commerce, 671
 “clicks-or-bricks” model, 683
 problems and advantages, 670–671
 returns, 684
 in supply chain management, 32, 670–671
- E-commerce, 25, 586–587
- Economic conditions
 economic indicators, 101–102
 as external factor, 48
 forecasting and, 101–102, 114–115. *See also* Forecasting
 for global operations, 354
 as key issue in operations, 27
 productivity as, 59. *See also* Productivity
 in product/service design, 141
- Economic order quantity (EOQ), 514–525
 annual carrying cost, 514–518
 annual ordering cost, 515–517
 assumptions, 514
 economic production quantity (EPQ), 518–520, 539
 formula summary, 539
 in lean operations, 618
 length of order cycle, 516–517
 in MRP, 575
 quantity discounts, 520–525
 total annual cost, 516–518
- Economic production quantity (EPQ), 518–520, 539
- Economies of scale, 21, 205–206
- EDD (earliest due date) priority rule, 704, 707, 709, 710
- EF (earliest finish time), 746, 747–749
- Effective capacity, 194–195
- Effectiveness
 of process layouts, 281–282
 productivity and, 61–62
- Efficiency
 in job design, 21–23, 302, 305, 306, 310–327
 in line balancing, 276
 productivity and, 62
 in strategic capacity planning, 195
 in supply chain management, 685–686
- Emerson, Harrington, 22
- Employees. *See* Workforce
- End-of-life (EOL) programs, 147, 153
- Energy productivity, 58
 fracking productivity improvement, 62
 OPEC embargo (1970s) and, 380
 at U.S. Postal Service (USPS), 72–73
- Engineer-to-order (ETO), 675
- Enterprise resource planning (ERP), 33, 581–589
 common mistakes, 587–589
 costs of, 584–586
 described, 581, 583
 e-commerce and, 586–587
 implementation time, 584, 585
 in improving business performance, 583–584
 integration with business, 584, 585
 lean operations and, 634
 operations strategy and, 582, 589
 payback, 585–586
 project management and, 734
 project organization and installation methods, 586
 reasons to implement, 584
 in service organizations, 587
 software configuration, 586
 software modules, 581, 582–583
 supply chain management and, 663–664
- Enumerative approach (linear programming), 837
- Environmental concerns, 27–29. *See also* Sustainability
 global warming/temperature changes, 29, 104
 “green initiatives,” 29, 658
 landfills, 174
 in product/service design, 146–151
 recycling, 69–70, 149–151, 174
 vegetarian vs. nonvegetarian diets, 29
- Environmental scanning, 47–48
- Equivalent current value, 212
- Equivalent interest rate, 212
- Ergonomics, 302, 305, 306, 312
- Erlang, A. K., 786
- ERP. *See* Enterprise resource planning (ERP)
- Errors. *See also* Forecasting error
 defined, 105
 PERT (program evaluation review technique), 763
 product recalls, 347, 614
 project management, 762–763
 in statistical process control (SPC), 429
 Type I/Type II, 429, 443
 in work sampling, 324
- ES (earliest start time), 746, 747–749
- Ethical framework, 29–30
- Ethics and ethical issues, 29–31
 ethical framework, 29–30
 ethical principles, 29
 ethics, defined, 29
 examples of corporate leaders, 30–31
 for global operations, 354
 in location decisions, 354, 360
 in product/service design, 144–145
 in project management, 739
 in purchasing, 669
 in quality management, 390–391, 424
 supply chain management and, 664, 673
 in working conditions, 308
- Ethisphere Institute, 30–31
- European Quality Award, 391
- European Union (EU), 149, 154, 352, 392
- Evans, J. R., 384n
- Event-response capability, 662
- Events, on network diagrams, 743
- Exception reports, in MRP, 574
- Excess capacity, 368
 duplicate orders, 469, 470
 problems of, 192
- Excess cost, 533
- Excess inventory, as waste in lean operations, 615–616
- Exchange rate risk, in location decisions, 358
- Excitement quality (Kano model), 161–162
- Executing phase (project life cycle), 735, 736
- Executive opinions, 80
- Expand-early strategy, 213
- Expansion, as location option, 352
- Expected monetary value (EMV) criterion, 227
- Expected value of perfect information (EVPI), 229–230
- Experimental design, 157
- Exponential smoothing, 87
 simple, 87–88, 112
 trend-adjusted, 92–93, 112
- Exporting
 small businesses and, 665
 in supply chain management, 665
- Extended warranties, 181
- External customer, 394
- External factors, in strategic capacity planning, 197
- External failures, 389–390
- Extrusion, 257
- Eyring, Veronika, 658n
- Fabrication, 15
- Facilities
 as internal factor, 49
 locating. *See* Location planning and analysis
 in strategic capacity planning, 196
- Facilities layout, 260–285
 combination layouts, 265–268
 fixed-position layouts, 261, 264–265
 importance, 260
 layout, defined, 260
 objectives, 260
 process layouts. *See* Process layouts
 product layouts. *See* Product layouts
 service layouts, 15, 263–264, 268–272
 in strategic capacity planning, 196
- Factor rating, 367
- Fail-safing, 394, 622
- Failure
 defined, 156
 extended warranties, 181
 external, 389–390
 internal, 389–390
 mean time between failures (MTBF), 178–180, 183–184
 preventive maintenance and, 261–262
 wear-out, 182–183
- Failure costs, 389–390
- Fairness Principle, 29
- Fair Trade Certified label, 30, 31
- Fazel, Farzaneh, 397n
- FCFS (first come/first service) priority rule, 704, 706, 709
- Feasibility analysis, in product design and development, 162
- Feasible solution space (linear programming), 826, 828–830, 833, 837
- Feedback
 on decision making, 16
 transformation process, 6
- Feeding (time) buffers, 763
- Feigenbaum, Armand, 382, 383
- Fill rate, 530, 682
- Finance function
 collaboration with operations management, 10, 11
 flow management, 656–657
 forecasting in, 76
 global operations and, 353
 as key functional area, 4, 10–11
 nature of, 4
- Financial analysis, 211–212
 cash flow, 211–212
 internal rate of return (IRR), 211–212
 inventory turnover, 507
 payback, 212, 585–586
 present value (PV), 211–212
 return on investment (ROI), 504, 585–586, 658
 return on quality (ROQ), 390

- Financial resources, as internal factor, 49
 Finished-goods inventory, 505. *See also* Inventory management
 aggregate planning and, 472–473
 in inspection decision, 422
 Finite element analysis (FEA), 165
 Finite loading, 698–699
 Finite-source situations (queuing), 789, 807–813
 finite-queuing tables, 809–811
 formulas and notation, 808
 First come/first service (FCFS) priority rule, 704, 706, 709, 792
 Fitness-for-use, 382, 383–384
 Fitzsimmons, James A., 166n
 Fitzsimmons, Mona J., 166n
 5W2H approach, 634
 Five forces model (Porter), 48
 Five S's, in lean operations, 632, 633
 Fixed automation, 254
 Fixed costs, in cost-volume analysis, 208–211
 Fixed-order-interval (FOI) model, 530–533, 539
 Fixed-period ordering, in MRP, 575–576
 Fixed-position layouts, 261, 264–265
 Flattening organizational structure, 26–27
 Flexibility. *See also* Agility
 competitiveness and, 42–43
 forecasting and, 78, 113
 in lean operations, 615, 620, 637–638
 in process strategy, 260
 in strategic capacity planning, 202, 213
 strategy based on, 46, 47, 50
 of work hours, 307
 Flexible automation, 255–257
 Flexible manufacturing systems (FMS), 255–256, 268
 Flowcharts, 401, 402, 403
 Flow management, 656–657
 Flow process charts, 312–313, 314
 Flow-shop scheduling, 694–696
 Flow systems, 694–696
 Focus forecasting, 88–89
 Following capacity strategy, 197–198, 206
 Following tasks, in line balancing, 277
 Follow-up evaluation, in product design and development, 163
 Food. *See also* Food service and restaurants
 Home-Style Cookies (case), 67–68
 product design at Vlastic Pickles, 143
 productivity in tomato production, 60
 quality control, 427
 sustainable production, 28, 29
 value analysis, 147, 148
 vegetarian vs. nonvegetarian diets, 29
 Food service and restaurants
 aggregate planning, 468
 capacity planning, 484
 cultural factors in product design, 146
 fast food in China, 386
 inspection points, 423
 mass customization, 155
 outsourcing preparation, 202, 221
 part-time workers and, 472
 quality control, 433
 repetitive processing, 262
 restaurant layouts, 270, 271
 service blueprint, 168
 transformation process, 8
 Foolproofing, 394, 622
 Ford, Henry, 22, 23, 24, 614
 Forecasting, 74–137
 accuracy/error in. *See* Forecasting error
 in aggregate planning, 468–469
 approaches to, 80
 cases, 136–137
 choosing a technique, 111–112
 common features, 78
 computer software in, 113
 of demand, 75–78, 114–115, 165, 198–199, 505–507, 509, 537
 elements of good forecasts, 78–79
 forecast, defined, 76
 formula summary, 116–117
 for goods vs. services, 9
 introduction, 76–78
 judgmental/opinion methods, 80–81, 116
 nature of, 76
 in operations strategy, 113
 qualitative methods, 80–81, 116
 quantitative/statistical methods, 80, 82–112, 116–117
 reactive/proactive approach to, 112–113
 in service organizations, 14
 steps in process, 79–80
 in strategic capacity planning, 192, 198–200
 in supply chain management, 32, 79, 114–115, 674, 678
 time horizons in, 76–79, 111–112, 113, 198–199
 use by business organizations, 76–78
 weather, 14, 75, 82, 93, 113
 in workforce scheduling, 717
 Forecasting error, 76, 78, 104–111
 control charts, 107–108, 111
 control limits, 108–111
 cost/accuracy trade-off, 111–112
 mean absolute deviation (MAD), 106–107, 109, 110
 mean absolute percent error (MAPE), 106–107
 mean squared error (MSE), 106–107, 108–110
 monitoring, 79–80, 107–111
 nature of errors, 105
 nonrandom errors, 108
 possible sources, 107
 standard error of estimate, 100–101
 tracking signals, 109–111
 Foroohar, Rana, 17
 Forrester, Jay, 24
 Forward pass, 749, 751
 Forward scheduling, 699
 Fraud. *See also* Ethics and ethical issues
 false inspection reports, 424
 Friedman, Norm, 221n
 Fulfillment, 663, 670–671, 675–676
 Functional strategies, 45
 Funding operations, 10
 Gantt, Henry, 22, 24
 Gantt charts, 22, 24, 697–700
 load chart, 698–699
 in project management, 741–742
 schedule chart, 700
 Garvin, David, 383n
 Gatekeeping, 684
 Gauntt, Joshua, 181n
 Gemba walks, 635
 General Agreement on Tariffs and Trade (GATT, 1994), 25
 General-purpose equipment, 263–264
 General-purpose plant strategy, 362
 Geographic information systems (GIS), 362–363
 Germany, cost savings from global locations, 352–353
 Ghoshal, Sumantra, 51n
 Gilbreth, Frank, 22, 23, 24, 305, 315–316
 Gilbreth, Lillian, 23, 305, 316
 Globalization, 25
 advantages/disadvantages, 352–354
 automation, 354–355
 capacity planning and, 193
 “Cocoa for Good” initiative, 28
 competitiveness and, 27
 European Union and, 149, 154, 352, 392
 in location planning and analysis, 352–355, 357–359, 361
 managing global operations, 354
 in product/service design, 146, 149
 recycling and, 149
 risks, 354, 358
 strategy based on, 51
 in supply chain management, 31–32, 659, 663, 665
 Global priority rules, 704–709
 Global warming, 29, 104
 Go, no-go gauge, 438
 Goal(s), 44
 of lean manufacturing, 615–616
 of maintenance, 646–647
 of strategic capacity planning, 192, 466
 of waiting-line management, 788
 Goal, *The* (Goldratt), 714–715
 Goldratt, Eli, 207, 714–715, 763
 Goldstein, Jacob, 311, 311n, 679n
 Goods, 4
 in goods-service continuum, 7
 process variation and, 14
 production of, vs. providing services, 8–10
 supply chains for, 4–6, 656, 657
 transformation processes, 6–8
 Goods-in-transit, 505
 Government service, location decisions, 359
 GPS navigation, 678
 Grant, Eugene, 433n
 Graphical linear programming, 828–840
 binding constraint, 839
 enumerative approach, 837
 identifying feasible solution space, 833
 minimization, 837–839
 outline, 828–830
 plotting constraints, 830–833
 plotting objective function line, 833–836
 redundant constraints, 836–837
 slack/surplus, 839–840
 Graphical tools, 401–408
 aggregate planning, 478–480
 cause-and-effect (fishbone) diagrams, 383, 402, 405, 406
 check sheets, 401–403, 406
 control charts, 402, 404–405, 407
 flowcharts, 401, 402, 403
 histograms, 401, 402, 404
 illustrations of use, 406–407
 Pareto analysis, 401–404, 406, 407
 problem solving/process improvement, 401–408
 run charts, 406
 scatter diagrams, 402, 404, 405

- Green, Erin H., 658n
 “Green initiatives,” 29, 658
 Groover, Mikell P., 280n
 Gross requirements, in MRP, 567, 568
 Group incentive plans, 309–310
 Group technology, 267–268, 619
 Growth
 productivity, 56–57
 as strategy, 49
 Growth phase of life cycle, 202–203
- Hagan, Alex, 311, 311n
 Harris, F. W., 23, 24
 Hawthorne studies, 23
 Health care
 capacity planning, 191, 221 (case), 484
 decision trees, 227
 drones in, 258
 facilities layouts, 269, 271
 inspection points, 423
 inventory management, 258, 504
 occupational, 307
 radio frequency identification (RFID) in, 253, 448
 robotic systems, 256
 scheduling, 718
 transformation process for hospitals, 8
Heijunka, 613
 Hertzberg, Frederick, 23
 Heuristic (intuitive) rules, in line balancing, 274, 276–279
 High-volume system scheduling, 694–696
 Histograms, 401, 402, 404
 History
 of operations management, 21–24
 of quality management, 380–383
 Holding (carrying) cost, 509–510
 economic order quantity (EOQ) model, 514–518
 incremental holding cost, 680
 in supply chain management, 680, 685
 Hook, Leslie, 149, 149n
 Horizontal loading, 303
 Horizontal skills, 310
 Hospitality business
 inspection points, 423
 reservations, 716
 Hospitals. *See* Health care
 Housekeeping, in lean operations, 632
 House of quality, 158–160, 161
 Howley, Lauraine, 62n
 Human factors
 in product/service design, 145
 in strategic capacity planning, 197
 Human relations movement, 23
 Human resources. *See* Personnel/human resources function
 Hungarian method, 701–704
- Idea generation
 benchmarking, 408
 brainstorming, 407
 in product/service design, 142–144
 quality circles, 382, 383, 407
 Imai, Masaaki, 616n
 Implied warranty, 144
 Import restrictions, global operations and, 353
 Incentive (output-based) systems, 308–310
 Incremental holding cost, 680
 Independence, 756
 path duration times, 756–758
 Independent contractors, 472
 Independent-demand items, 504, 575. *See also*
 Inventory management
 Independent events, 177–178
 Indifference point, 209
 Individual incentive plans, 309
 Industrial engineering, operations management and, 16
 Industrial parks, 361
 Industrial Revolution, 21, 24, 380
 Inefficiency, as waste in lean operations, 616
 Infinite loading, 698–699
 Infinite-source situations (queuing), 789, 790, 793–807
 basic relationships, 794–795
 infinite-source tables, 798–799
 symbols, 793
 Information technology (IT), 25, 252–253
 in supply chain management, 659–661, 666
 Information velocity, 682
 Initiating phase (project life cycle), 734, 736
 Innovation
 competitiveness and, 42
 history of operations management and, 21–24
 as key issue in operations, 27
 in manufacturing, 17
 newness strategy and, 46, 47, 54
 in supply chain management, 657–662, 665
 technological, 25, 252. *See also* Technology
 Input/output (I/O) control, 700, 701
 Inputs
 aggregate planning, 469, 470
 examples of, 7
 for goods vs. services, 9, 10
 managing processes to meet demand, 13–14
 master production schedule, 488
 material requirements planning, 562, 563–566
 in transformation process, 7, 8
 Inspection, 420–425
 as acceptance sampling, 419, 420
 amount and frequency, 421–422
 basic issues, 420–421
 off-site vs. on-site, 424–425
 points in process, 420, 422–423
 as process control, 420
 Institute for Operations Research and the Management Sciences (INFORMS), 13
 Institute for Supply Management (ISM), 13
 Institute of Industrial Engineers, 13
 Institute of Packaging Professionals, 142
 Intellectual property rights, 354
 patents, 9, 10, 17, 143
 Interchangeable parts, 22, 153
 Intermediate-range planning. *See* Aggregate planning
 Intermediate-volume system scheduling, 696–697
 Intermittent processing, 261, 263–264
 Internal customer, 382, 394
 Internal failures, 389–390
 Internal rate of return (IRR), 211–212
 International Design Excellence Award, 152
 International Ergonomics Association, 305
 International Standards Organization (ISO), 392–393
 ISO 9000, 392–393, 672, 740
 ISO 14000, 392–393
 ISO 24700, 393
 Internet, 24, 61
 Internet of Things (IoT), 257
 Introduction phase of life cycle, 202
 Inventory, 503
 in intermediate-volume system scheduling, 696–697
 in lean operations, 612, 615, 621–622
 in theory of constraints, 715
 Inventory management, 502–559
 aggregate planning and, 472–473
 buffer inventory, 506, 650, 674–675
 cases, 553–555
 classification system, 507, 510–513
 competitiveness and, 43
 demand forecasts, 507, 509
 ERP and, 582
 for goods vs. services, 9, 10
 inventory, defined, 503
 inventory costs, 506–507, 509–510, 526–527
 inventory counting systems, 507–509
 inventory functions, 505–506
 inventory types, 505
 lead-time information, 507, 509
 in lean operations, 612, 615–616, 621–622
 learning curves in, 341
 master production schedule (MPS), 467, 488–491
 nature and importance of inventories, 504–507
 objective, 506–507
 in operations strategy, 538
 ordering policies. *See* Inventory ordering policies
 “real world” vs. “intuitive approach,” 504, 506–507
 requirements for effective, 507–513
 in service organizations, 15, 504
 small businesses and, 664–665
 in supply chain management, 32, 33, 538, 664–665, 674–675
 vendor-managed inventory (VMI), 638, 675, 677
 at Wegmans Food Markets, Inc., 34–35
 Inventory ordering policies, 513–537
 economic order quantity (EOQ) models, 514–525, 539
 economic production quantity (EPQ), 518–520, 539
 fixed-order-interval (FOI) model, 530–533, 539
 quantity discounts, 506, 520–525, 539
 reorder point (ROP) ordering, 525–530, 539
 single-period model/newsboy problem, 533–537, 539
 Inventory order size, 23
 Inventory records, 566
 Inventory turnover, 507
 Inventory velocity, 674
 Investment proposals, 10
 Irregular variations
 defined, 82
 in forecasting, 82, 83
 Ishikawa, Kaoru, 24, 382, 383
 Ishikawa diagrams, 383, 402, 405, 406
 ISO 9000, 392–393, 672, 740
 ISO 14000, 392–393
 ISO 24700, 393

- Japan
 influence on manufacturing process, 23–24, 611, 612. *See also* Lean operations
 influence on quality management, 381–383, 395, 447, 448, 612
 shoplifting prevention, 510
- Jidoka*, 613
- JIT II, 638
- Job design, 301–305
 behavioral approaches, 302, 303
 efficiency approaches, 21–23, 302, 305, 306, 310–327
 ergonomics, 302, 305, 306
 human relations movement and, 23
 motivation, 303
 in operations strategy, 327–328
 specialization, 302–303
 teams, 303–305
- Job enlargement, 303
- Job enrichment, 303
- Job flow time, 705
- Job lateness, 705
- Job rotation, 303
- Job shop processing, 247, 248, 249
- Job-shop scheduling, 697–713
 loading, 697–704
 sequencing, 704–713
- Job time, 704
- Jockeying, 792
- Johnson, Kevin, 355
- Johnson's rule, 711–713
- Jones, Daniel, 612
- Judgmental forecasts, 80–81
 consumer surveys, 81
 Delphi method, 81
 executive opinions, 80
 salesforce opinions, 81
- Juran, Joseph M., 23–24, 381, 382, 383, 390
- Just-in-time (JIT). *See also* Lean operations
 defined, 611
 problems, 613, 614, 634
 supply chain and, 634
- Kaizen*, 382, 395, 613, 616
- Kaminsky, Philip, 670n
- Kanban*, 613, 627–629
- Kano, Noriaki, 160–162
- Kano model, 160–162
- Kaplan, Robert S., 54–56
- Kasibhatla, Prasad, 658n
- Kiosks, 270
- Knod, Edward M., 620n
- Knowledge-based pay, 310
- Knowledge skills, 12
- Koch, Christopher, 583–587
- Labeling, 142
- Labor content, for goods vs. services, 9, 10
- Labor factors, in location decisions, 359
- Labor productivity, 58
 location decision and, 353, 354, 358, 359
 turnover and, 61
- Labor turnover, productivity and, 61
- Language factors, in global operations, 354
- Laplace decision criterion, 225–226
- Laser technology, 253
- Lauer, Axel, 658n
- Layout. *See* Facilities layout
- Leadership, in lean operations, 624
- Leading capacity strategy, 197, 206
- Leading variable, 98
- Lead time, 113, 527–530
 cumulative, in MRP, 563
 defined, 11, 509
- Lean culture, 612, 636
- Lean operations, 303, 420, 538, 610–645
 balanced system, 620–621
 basic elements, 611
 benefits and risks of lean systems, 613
 building blocks, 616–632
 case, 643
 characteristics of lean systems, 612–613
 defined, 611
 demand in, 612, 626–627
 fail-safe methods, 394, 622
 goals, 615–616
 lean services, 637–638
 manufacturing cells, 619
 manufacturing planning and control, 624–632
 minimizing inventory storage, 621–622
 in operations strategy, 638–639
 origins, 611, 612, 614
 overview, 640
 personnel/organizational elements, 622–624
 principles of, 613
 process design, 252, 617–622
 product design, 616–617
 quality improvement, 619
 setup time reduction, 618–619
 small lot sizes, 617–618
 in supply chain management, 659, 665
 Toyota Production System (TPS), 611, 612, 613–615, 635
 traditional production philosophies vs., 632
 transitioning to lean system, 635–637
 work flexibility, 615, 620
- Lean process design, 252, 617–622
- Lean systems, 26–27, 113, 280. *See also* Agility; Just-in-time (JIT)
- Lean tools, 632–635
 enterprise resource planning (ERP), 634
 5W2H approach, 634
 gemba walks, 635
 JIT deliveries, 634
 Six Sigma, 634
 value stream mapping, 632–633
 vendor-managed inventory (VMI)/JIT II, 638, 675, 677
- Learning curves, 336–347
 applications, 340–342
 case, 347
 cautions and criticisms, 342–343
 concept of, 336–340
 doubling effect, 337–338
 as experience curves, 336–337
 learning curve coefficients, 338–340
 operations strategy and, 342
- Least squares line, 98–99
- Leavenworth, Richard, 433n
- Legal department, collaboration with operations, 12
- Legal environment
 as external factor, 48
 for global operations, 353, 354
 in product/service design, 141, 142, 144–145
 for working conditions, 308
- Leonard, Matt, 660n
- Level capacity strategy
 in aggregate planning, 473–476, 492
 defined, 474
 in lean operations, 624–626
- Leveraged buyouts, 52
- LF (latest finish time), 746, 749–750
- Liedtke, Michael, 787n
- Life cycle
 cradle-to-grave assessment, 146–147
 end-of-life (EOL) programs, 147, 153
 extended warranties and, 181
 product life cycle management (PLM), 153
 in product/service design, 146–147, 151–153, 248
 project, 734–736
 stages of, 202–203
 in strategic capacity planning, 202–203
- Lilac Festival (Rochester, NY), 104
- Lindsey, W. M., 384n
- Linear programming (LP), 824–856
 in aggregate planning, 481–482, 483
 assignment model of scheduling, 701–704
 cases, 853–855
 components, 826–827
 computer solutions, 840–843
 graphical, 828–840
 linear programming models, 826–828
 nature of, 825–826
 sensitivity analysis, 843–846
 Simplex method, 840
 transportation model, 366
 transportation table, 481–482, 483
- Linear regression analysis, 80, 98–104
 multiple regression, 102, 104
 regression equation, 103
 simple linear regression, 80, 98–104
- Linear trend equation, 89–92
- Line balancing, 272–280, 695–696
 cycle time, 273–274, 276, 277–279
 guidelines, 276–279
 importance, 272
 in lean operations, 620–621
 other approaches, 279–280
 other factors, 279
 precedence diagrams, 274–276, 277–279
- Little's law, 506, 629
- Load chart, 698–699
- Loading, 697–704
 assignment model of linear programming, 701–704
 Gantt charts, 697–700
 Hungarian method, 701–704
 input/output (I/O) control, 700, 701
 schedule charts, 700
- Load reports, 579–580
- Local priority rules, 704–709
- Locational cost-profit-volume analysis, 364–366
- Location planning and analysis, 348–377
 case, 377
 competitiveness and, 42
 evaluating location alternatives, 364–370
 general procedures, 355–370
 geographic information systems (GIS), 362–363
 global locations, 352–355, 357–358
 for goods vs. services, 9
 identifying location alternatives, 356–363
 key factors, 356–357
 location options, 352

- in manufacturing. *See* Manufacturing location planning and analysis
- nature of location decisions, 350–352, 364
- need for location decisions, 350
- objectives of location decisions, 351
- in process layout design, 282–285
- in service and retail businesses, 9, 15, 358–359, 363–364
- in strategic capacity planning, 196
- strategy based on location, 47
- in supply chain management, 32, 33, 351
- Logistical transactions, 631
- Logistics, 676–681
 - defined, 656, 676
 - evaluating alternatives, 680–681
 - incoming and outgoing shipments, 678
 - movement within a facility, 676–677
 - navigation, 678
 - reverse, 683
 - in supply chain management, 32, 656, 676–681
 - third-party logistics (3-PL), 681
 - tracking goods, 678–680, 681
 - Wegmans' shipping system, 677–678
- Loma Linda University, 29
- Long-range forecasting, 76, 77
- Long-range planning
 - capacity planning. *See* Strategic capacity planning
 - layout decisions. *See* Facilities layout
 - location decisions. *See* Location planning and analysis
 - in perspective, 466–467
 - product design. *See* Product design and development; Service design and development
 - work system design. *See* Job design; Work measurement
- Long-term capacity, 198, 200
- Lot-for-lot ordering, in MRP, 568–571, 575
- Lot-size ordering, in MRP, 568–571, 575–576
- Lowell Center, 252
- Lower control limit (LCL), 428–429, 430–431, 435–437
- Low-level coding, 566
- Low-volume system scheduling. *See* Job-shop scheduling
- LS (latest start time), 746, 749–750
- Lubbers, Sarah, 554–555
- Lusche, Chris, 554–555

- MacDonald, Jim, 142
- Machine productivity, 58
- Machine shops, 263–264
- Machine That Changed the World, The* (Womack et al.), 612
- MacLellan, Lila, 355n
- MAD (mean absolute deviation), 106–107, 109, 110
- Maintenance, 646–652
 - breakdown, 647, 650, 696
 - design issues in, 649
 - goal of, 646–647
 - operations management and, 16
 - predictive, 649
 - preventive, 261–262, 632, 647, 648–650, 696
 - replacement, 650
- Maintenance and repairs (MRO) inventory, 505
- Maister, David H., 814
- Makespan, 705
- Make-to-order (MTO), 675
- Make-to-stock (MTS), 676
- Maki, Ayaka, 510n
- Malcolm Baldrige National Quality Award, 388, 391
- Management information systems (MIS)
 - collaboration with operations, 12
 - forecasting in, 77
- Management science, 23
- Managers
 - competitiveness and, 43
 - of global operations, 354
 - implications of waiting lines, 787
 - management compensation, 310
 - operations managers. *See* Operations managers
 - project managers, 737–740
 - role in forecasting process, 78
 - statistical process control (SPC) considerations, 437–438
 - top. *See* Top management
- Manufacturability, 11
 - defined, 141, 165
 - in product design, 141, 165
- Manufacturing
 - importance of manufacturing sector, 17
 - outsourcing. *See* Outsourcing
 - providing services vs., 8–10. *See also* Goods supply chain management. *See* Supply chain management
 - typical supply chain, 657
- Manufacturing location planning and analysis, 350–363, 364–369
 - community identification, 359–360, 361
 - country identification, 357–358
 - evaluating location alternatives, 364–370
 - general procedure, 355–363
 - global operations, 352–355, 357–359, 361
 - multiple plant manufacturing strategies, 361–362
 - nature of location decisions, 350–352, 364
 - need for location decisions, 350
 - region identification, 358–359, 361
 - site identification, 360–361
- Manufacturing planning and control, 624–632
 - close vendor relationships, 629–630
 - housekeeping, 632
 - level loading, 624–626
 - limited work-in-process (WIP), 629
 - preventive maintenance, 632
 - pull systems, 626–627
 - reduced transaction processing, 631
 - supplier tiers, 630–631
 - visual systems, 612, 627–628
- Manufacturing resources planning (MRP II), 577–578
- MAPE (mean absolute percent error), 106–107
- Market(s)
 - as external factor, 49
 - global operations and, 352
 - in location decision, 358–359
- Market area plant strategy, 362
- Marketing function
 - collaboration with operations, 11, 46, 53, 199, 200
 - ERP and, 582
 - forecasting in, 77
 - influences on competitiveness, 42
 - as key functional area, 4, 11
- nature of, 4
- quality and, 388
- strategy formulation and, 53
- Market test, in product design and development, 163
- Markula Center for Applied Ethics, Santa Clara University, 29–30
- Maslow, Abraham, 23
- Mass customization, 154–156, 170, 248
- Mass production, 22
- Master production schedule (MPS)/master schedule, 467, 486–491, 563
 - available-to-promise (ATP) inventory, 488–491
 - in capacity requirements planning, 579–580
 - inputs, 488
 - in intermediate-volume system scheduling, 697
 - master scheduler role, 486–487
 - in material requirements planning (MRP), 486, 563, 566
 - outputs, 488–491
 - projected-on-hand inventory, 488–491
 - rough-cut capacity planning (RCCP), 487
 - time fences, 487–488
- Material requirements planning (MRP), 562–578
 - benefits and requirements, 576–577
 - capacity requirements planning, 579–581
 - cases, 605–606
 - closed-loop, 578
 - inputs, 562, 563–566
 - kanban and, 628–629
 - lot sizing, 575–576
 - manufacturing resources planning (MRP II), 577–578
 - master production schedule (MPS) in, 486, 563, 566
 - outputs, 562, 573–574
 - overview, 562
 - problems, 629
 - processing, 562, 566–573
 - safety stock, 574–575
 - in service organizations, 576
 - updating the system, 572–573
- Mathematical models, 18
 - in aggregate planning, 480–483
 - linear programming (LP). *See* Linear programming (LP)
 - simulation models. *See* Simulation models
 - transportation model, 366
 - transportation tables, 481–482, 483
- Matrix organization, 736–737
- Maturity phase of life cycle, 203
- Maximax decision criterion, 225–226
- Maximin decision criterion, 225–226
- Mayo, Elton, 23, 24
- McGregor, Douglas, 23
- McKinsey Global Institute, 20
- Mean (average), 14
- Mean absolute deviation (MAD), 106–107, 109, 110
- Mean absolute percent error (MAPE), 106–107
- Mean control charts, 430–434
- Mean squared error (MSE), 106–107, 108–110
- Mean time between failures (MTBF), 178–180, 183–184
- Median, in run tests, 439–442
- Mergers and acquisitions, 52

- Methane recycling, 174
 Methods analysis, 310–314
 Methods Engineering Council, 323
 Methods-time-measurement (MTM), 323
 Microfactories, 360
 Micromotion study, 316
 Miller, Jeffrey G., 631, 631n
 Mills, Karen, 619n
 Minimax regret decision criterion, 225, 226
 Minimization (linear programming), 837–839
 Mission, 44, 52
 Mission statement, 44
 Mistake-proofing, 394
 Mixed capacity strategy, in aggregate planning, 473–474, 492
 Mixed model line, 281
 Mixed-model sequencing, 625
 Models, 18–19
 analytics, 20
 benefits and limitations of, 19
 decision making, 18–19, 23
 in management science, 23
 types of, 18
 Modular design, 155–156, 468, 617
 Moira, Alexander, 740
 Monitoring phase (project life cycle), 735, 736
 Most likely time, 753
 Motion study, 305, 315–316
 Motion study principles, 315
 Motivation, in job design, 303
 Mourdoukoutas, Panos, 355n
 Moving, as location option, 352
 Moving assembly lines, 22
 Moving average, 84–86, 112
 MRP. *See* Material requirements planning (MRP)
 MRP II (manufacturing resources planning), 577–578, 628
 MSE (mean squared error), 106–107, 108–110
Muda, 613, 615–616
 Multifactor productivity measures, 57, 58–59
 Multiple break-even quantities, 210
 Multiple-priority model, 793, 804–807
 Multiple projects, 764
 Multiple regression analysis, 102, 104
 Multiple servers, exponential service time, 793, 797–801
 Multiple-source purchasing, 630
 Multiplicative model, 94
 Murray, Joseph, 69
 Muther, Richard, 284, 284n
 Muther grid, 284
 Myers, Anthony, 28n

 Naive forecasts, 82–83
 Nascimento Rodrigues, Jorge, 616n
 National Association of Purchasing Managers, 669
 National Institute of Standards (NISO), 388
 Near-sourcing, 665
 Necessity, in location of raw materials, 358
 Negative exponential distributions, of service patterns, 790, 791–792
 Net-change systems, 572–573
 Net requirements, in MRP, 567, 568, 571
 Network (precedence) diagrams, 742, 743–745
 activity-on-arrow (AOA), 743, 744–750
 activity-on-node (AON), 743, 750–752
 conventions, 744–745
 dependent path durations, 758–759
 determining path probabilities, 756–758
 events, 743
 expected activity times and variances, 754–755
 expected duration and standard deviation, 754–755
 independent path duration times, 756–758
 nature and purpose, 743–744
 simulation, 758–759
 New demand, in aggregate planning, 471
 New locations, as location option, 352
 Newness strategy, 46, 47, 54
 New products/services
 degree of newness, 158
 “first-to-market” approach, 170
 learning curves in pricing, 341
 product introduction, 163
 in supply chain management, 666
 Newsboy problem. *See* Single-period model
 Nichols, Megan Ray, 661n
 Niebel, Benjamin W., 307n, 313n, 315n, 317n, 322n
 Nodes, decision tree, 228–229
 Noise and vibrations, 306, 307
 Nonlinear regression, 104
 Nonrandom (assignable) variation, 14, 425, 439, 441–442, 443
 Nonrenewable resources, 150
 Normal distribution
 in forecasting demand, 199
 tables, 870–872
 working with, 876–880
 Normal operating conditions, 156
 Norman, Ed, 271
 Norton, David P., 54–56
 Numerically controlled (N/C) machines, 254–255

 Objective function (linear programming), 826, 833–836
 Objective function coefficient changes (sensitivity analysis), 843–844
 Occupational Safety and Health Act (1970), 308
 Occupational Safety and Health Administration (OSHA), 308
 Office layouts, 271
 Ohno, Taiichi, 24, 382, 383, 611, 635
 Operational decisions, 16, 33, 44
 Operational factors
 in strategic capacity planning, 197
 in supply chain management, 666
 Operational processes, 13
 Operations management
 career opportunities, 12
 collaboration with other functional areas, 10–12, 46, 53, 199, 200
 current state of, 24–27
 decision making in, 16, 18–20, 223–224
 defined, 4
 design of operations function, 6–8
 forecasting in, 77. *See also* Forecasting
 historical evolution of, 21–24
 implications of organization strategy for, 54
 importance, 10–12
 influences on competitiveness, 42–43
 interface with purchasing, 667
 introduction, 4–8
 as key functional area, 4, 10–12
 key issues in, 27–33
 nature of, 3, 4–8
 operations tours. *See* Operations Tours
 for producing goods vs. providing services, 8–10
 professional associations, 12–13
 quality and, 388
 sample job descriptions, 12
 scope in manufacturing business, 15–17
 scope in service organizations, 14–15
 strategic decision areas, 52, 53
 supply chain management and, 15–17, 582
 Operations managers
 decision making by, 16, 18–20, 223–224
 ethical decisions of, 30
 key function of, 16–17
 strategy formulation and, 53
 Operations strategy, 51–53
 Balanced Scorecard (BSC), 54–56
 capacity planning in, 193–194, 197–198, 202–206, 213
 ERP and, 582, 589
 examples of, 47
 forecasting in, 113
 inventory management in, 538
 lean operations in, 638–639
 learning curves in, 342
 location decisions in, 350–351
 nature of, 25–26, 41, 52
 operations management decision areas, 52, 53
 product/service design as, 140, 141, 170
 project management, 764–765
 quality-based strategies, 52–53, 409
 quality management, 448
 in scheduling, 719
 time-based strategies, 53
 in waiting-line management, 814–815
 work design and measurement in, 327–328
 Operations Tours, 33
 Boeing, 644
 Bruegger’s Bagel Bakery, 556
 High Acres Landfill (New York), 174
 Morton International, 250–251
 PSC, Inc., 557–559
 Stickley Furniture, 606–609
 U.S. Postal Service (USPS), 70–73
 Wegmans Food Markets, Inc., 33–35
 Wegmans’ Shipping System, 677–678
 Opinion forecasts. *See* Judgmental forecasts
 Opportunity cost, 470
 Optimal operating level, 205–206
 Optimistic time, 753
 Order cycles, 506
 economic order quantity (EOQ) model, 516–517
 Order fulfillment, 663, 670–671, 675–676
 Ordering costs, 510
 economic order quantity (EOQ) model, 514–518
 Order monitoring, 668
 Order qualifiers, 48
 Order releases, in MRP, 574
 Order winners, 48
 Organizational structure
 flattening, 26–27
 matrix organization, 736–737
 Organization of Petroleum Exporting Countries (OPEC), 380
 Organization strategy
 Balanced Scorecard (BSC), 54–56
 examples of, 47, 50–51, 54
 implications for operations management, 54
 nature of, 41, 45, 52

- OSHA (Occupational Safety and Health Administration), 308
- Ouchi, William, 23
- Output-based (incentive) systems, 308–310
- Output rate, 273
- Outputs
- aggregate planning, 469, 470
 - examples of, 7
 - for goods vs. services, 10
 - managing processes to meet demand, 13–14
 - master production schedule, 488–491
 - material requirements planning (MRP), 562, 573–574
 - output constraints in line balancing, 276–277
 - in transformation process, 7, 8
- Outsourcing
- in aggregate planning, 473
 - defined, 31
 - environmental issues in, 29
 - impact of, 17, 29
 - productivity and, 61
 - in strategic capacity planning, 201–202, 205–206, 221
 - as strategy, 49
 - in supply chain management, 31, 33, 658–659, 663
- Overproduction, as waste in lean operations, 616
- Overstocking costs, 506–507
- Overtime work, 205, 472
- Packaging
- in product design, 142, 148, 149–151, 170
 - quality and, 388
 - recycling, 69–70, 150–151
- Parallel workstations, 279–280
- Parameter design, 157
- Parameters (linear programming), 826
- Parasuraman, A., 384n, 385n
- Pareto, Vilfredo, 401
- Pareto analysis, 401–404, 406, 407
- Pareto phenomenon, 20, 650
- Part families, 266
- Partial productivity measures, 57–58
- Part-time workers, aggregate planning and, 472
- Patents
- development of, 143
 - for goods vs. services, 9, 10
 - in manufacturing process, 17
- Paths, network diagram, 743–744
- Pay. *See* Compensation
- Payback, 211–212
- in ERP, 585–586
- Payoff table, 223
- p*-charts, 434–436
- Pegging, 572
- People skills, 12
- Percentage of idle time, 275–276
- Pereira, Ron, 635n
- Perez, Marvin G., 28n
- Performance-control reports, in MRP, 574
- Performance metrics, 19
- job sequencing, 705–710
 - productivity, 9, 10
 - project management, 739
 - supply chain, 682
 - in theory of constraints, 715
 - waiting-line management, 792–793
- Performance quality (Kano model), 161–162
- Periodic orders, 506
- Periodic system, 507, 508
- Perishability, in location of raw materials, 358, 359
- Perpetual inventory system, 507–508
- Personnel/human resources function. *See also* Workforce
- collaboration with operations, 12
 - ERP and, 582, 584
 - forecasting in, 76
 - as internal factor, 49
 - in lean operations, 622–624
- PERT (program evaluation and review technique), 742–745, 765. *See also* Network (precedence) diagrams
- advantages, 762
 - potential errors, 763
- Pessimistic time, 753
- Phillips, Erica E., 149, 149n
- Physical models, 18
- Pipeline inventories, 506
- Pisani, Joseph, 787n
- Pisano, Gary, 17, 17n
- Plambeck, Erica L., 470n
- Plan-do-study-act (PDSA) cycle, 398–399
- Planned-order receipts, in MRP, 568
- Planned-order releases, in MRP, 568, 570–571
- Planned orders, in MRP, 574
- Planning phase (project life cycle), 735, 736
- Planning reports, in MRP, 574
- Point-of-sale (POS) systems, 508–509
- Poisson distribution
- of arrival patterns, 790–792
 - in forecasting demand, 199, 537
 - table, 873–874
- Poka-yoke*, 394, 622
- Policy factors, in strategic capacity planning, 197
- Political conditions
- as external factor, 48
 - for global operations, 354
 - in product/service design, 141
- Pollution, 29
- Population source (queuing)
- finite-source situations, 789, 807–813
 - infinite-source situations, 789, 790, 793–807
- Porter, Michael E., 48, 48n
- Positional weight, 277
- Precedence diagrams, 274–276, 277–279
- Preceding tasks, in line balancing, 277
- Predetermined time standards, 323
- Predictability, learning curve, 337
- Predictive maintenance, 649
- Predictor variables, 98
- Present value, 211–212
- Prevention costs, 389, 390
- Preventive maintenance, 261–262, 647, 648–650
- breakdown maintenance vs., 648–649
 - defined, 632
 - high-volume system scheduling, 696
 - in lean operations, 632
- Price and pricing
- in aggregate planning, 470
 - competitiveness and, 42
 - degree of price elasticity, 470
 - inventory management and, 506
 - learning curves in setting, 341
 - quantity discounts, 506, 520–525, 539
 - price strategy, 47, 54
- Primary reports, in MRP, 573–574
- Principles of Scientific Management, The* (Taylor), 21
- Priorities, 20
- Priority rules, 704–710
- assumptions, 705
 - global, 704–709
 - job sequences using, 705–710
 - local, 704–709
 - performance measures, 705
 - in scheduling services, 715
- Proactive approach to forecasting, 112–113
- Probabilistic time estimates, 745, 753–755
- Problem solving
- basic steps, 398
 - graphical quality tools, 401–408
 - in lean operations, 623, 637
 - in total quality management (TQM), 398–408
- Process
- categories of business processes, 13
 - defined, 13
 - in strategic capacity planning, 196
- Process batch, 715
- Process capability, 443–448
- capability analysis, 444–447
 - defined, 444
 - formula summary, 450
 - improving, 447
 - limitations of capability indexes, 447
 - specifications and, 443, 444, 446–447
 - Taguchi loss function, 447, 448
 - variability of process output, 443–444
- Process design and development
- high-volume system scheduling, 696
 - in lean operations, 617–622
 - in lean services, 637–638
 - robust design in, 157
 - technology in, 25
- Process improvement, 26, 398–408
- graphical quality tools, 401–408
 - overview, 399
 - Six Sigma, 26, 161, 400, 446
 - in total quality management (TQM), 398–408
- Processing, in supply chain management, 32
- Process layouts
- advantages/disadvantages, 264
 - cellular layouts vs., 266, 267
 - closeness ratings, 284–285
 - in combination layouts, 265–268
 - described, 261, 263–264
 - designing, 281–285
 - information requirements, 282
 - measures of effectiveness, 281–282
 - minimizing transportation costs or distances, 282–283
- Process management
- categories of business processes, 13
 - for goods vs. services, 8
 - to meet demand, 13–14
 - process variation, 14
- Process plant strategy, 362
- Process research & development (R&D), 143
- Process selection, 246–259
- defined, 246
 - importance, 245, 246
 - lean process design, 252
 - process strategy, 246, 260
 - process types, 247–251
 - product and service profiling, 251–252
 - sustainable production of goods and services, 252
 - technology in, 252–259

- Process specifications, in product design and development, 163
- Process strategy, 260
- Process technology, 25, 252, 253. *See also* Technology
- Process types, 247–251
 batch, 67, 247, 248, 249, 715
 continuous, 247, 248, 249, 250–251
 job shop, 247, 248, 249
 project, 249–251
 repetitive/assembly, 247, 248, 249
- Process variability, 14, 425, 443–444
- Process variation, 14
- Process yield, 60, 423
- Procurement. *See* Purchasing/procurement function
- Product(s)
 calculating processing requirements, 199–200
 flow management, 656
 as internal factor, 49
 recalls, 347, 614
- Product bundle, 166
- Product design and development, 162–165. *See also* Product/service design
 component commonality, 165
 computer-aided design (CAD), 164–165
 concurrent engineering, 163–164, 617
 design for disassembly (DFD), 149
 design for recycling (DFR), 149
 high-volume system scheduling, 696
 in lean operations, 616–617
 packaging in, 142, 148, 149–151, 170
 phases in, 162–163
 production requirements, 163, 165
 quality considerations, 380, 383, 385, 386, 387, 419–425, 448. *See also* Quality management
 recycling, 149–151
 remanufacturing, 148–149
 service design vs., 166–167, 169
 technology in, 25
 value analysis, 147–148
- Product families, 165
- Product introduction, in product design and development, 163
- Production and Operations Management Society (POMS), The, College of Engineering, Florida International University, 13
- Production capabilities, 163, 165
- Production decisions
 process selection. *See* Process selection in supply chain management, 33
- Production flexibility, in lean operations, 615, 620
- Production *kanban* (p-kanban), 627
- Production lines
 defined, 261
 line balancing, 272–280
- Production planning function, ERP and, 582
- Production process
 quality and, 388
 robust design in, 157
- Productivity, 41, 56–62
 competitiveness and, 42, 59
 computing, 57–59
 factors that affect, 60–61
 importance, 59
 improving, 31, 61–62
 labor, 58, 61, 353, 354, 358, 359
- metrics for goods vs. services, 9, 10
 motion study, 305, 315–316
 multifactor measures, 57, 58–59
 partial measures, 57–58
 quality and, 389
 in service sector, 59–60
 of U.S. Postal Service (USPS), 71
- Productivity growth, 56–57
- Product layouts, 261–263
 advantages/disadvantages, 262–263
 assembly lines, 261
 in combination layouts, 265–268
 defined, 261
 line balancing, 272–280
 preventive maintenance, 261–262
 production lines, 261
 U-shaped, 263
- Product liability, 144
- Product life cycle management (PLM), 153
- Product mix, 200, 696
- Product packages, 6
- Product plant strategy, 362
- Product profiling, 251–252
- Product/service design, 138–174. *See also* Product design and development; Service design and development
 activities and responsibilities of, 140
 as business operations strategy, 140, 141, 170
 capacity planning and, 196, 202
 competitiveness and, 42
 cultural factors, 145–146
 customer satisfaction in, 141, 142, 158–162, 167, 170
 degree of newness, 158
 forecasting in, 77
 globalization, 146, 149
 human factors, 145
 idea generation in, 142–144
 interface with purchasing, 667
 Kano model, 160–162
 key questions, 141
 legal and ethical considerations, 141, 142, 144–145
 life cycle in, 146–147, 151–153
 mass customization, 154–156
 objectives, 141
 operations strategy, 170
 preventive maintenance and, 649
 productivity and, 61
 product or service life stages, 146–147, 151–153, 248
 quality function deployment (QFD), 158–160, 161
 reasons for design or redesign, 141–142
 reliability, 156–157. *See also* Reliability
 robust design, 157
 standardization, 22, 61, 153–154
 in supply chain management, 32
 sustainability in, 146–151
- Product/service technology, 25
- Product specifications, in product design and development, 162
- Product structure trees, in MRP, 563–565, 572
- Profitability, transformation process, 6
- Profit Impact of Market Strategy (PIMS) database, 49–50
- Programmable automation, 254–255
- Programmable robots, 255
- Project(s)
 defined, 249, 734
 nature of, 734, 736–737
- Project (time) buffers, 763
- Project champions, 740
- Projected on hand, 488–491, 567
- Project life cycle, 734–736
- Project management, 732–782
 behavioral issues, 739
 budget control, 739, 759
 case, 781
 computing algorithm, 746–753
 CPM (critical path method), 742–745
 crashing, 759–762
 critical chain project management (CCPM), 763
 determining path probabilities, 756–758
 deterministic time estimates, 745–746
 ethics, 739
 Gantt charts, 741–742
 key decisions, 737–738
 nature of projects, 734, 736–737
 network diagram/conventions, 743–745
 operations strategy, 764–765
 overview, 735
 PERT (program evaluation and review technique), 742–745, 762–763, 765
 potential sources of error, 762–763
 probabilistic time estimates, 745, 753–755
 project champions, 740
 project life cycle, 734–736
 project management software, 764, 765
 project management triangle, 739
 project manager, 737–740
 pros and cons of projects, 740–741
 risk management, 765–766
 simulation, 758–759
 termination decision, 738
 virtual project teams, 763–764
 work breakdown structure (WBS), 741
- Project Management Body of Knowledge (PMBOK), 738–739
- Project Management Institute (PMI), 13, 735, 738–739, 740
- Project management triangle, 739
- Project managers, 737–740
- Project planning and design, 737
- Project processing, 249–251
- Project slippage, 764
- Project teams
 evaluation methods, 739
 matrix organization, 737
 selecting, 737
 virtual, 763–764
- Promotion
 in aggregate planning, 470–471
 competitiveness and, 42
- Prototype development, in product design and development, 163
- Public relations department, collaboration with operations, 12
- Pull systems, 626–627
- Purchase cost, 509
- Purchased parts, in inspection decision, 422
- Purchasing cycle, 667–668
- Purchasing/procurement function
 centralized vs. decentralized, 668–669
 ERP and, 582
 ethics in, 669
 interfaces, 667

- learning curves in, 340–341
- operations management and, 16
- purchasing cycle, 667–668
- quality and, 388
- strategic sourcing, 681–682
- supply chain management and, 32, 33, 667–669, 681–682
- at Wegmans Food Markets, Inc., 34–35
- Push systems, 626
- Pyxis® ProcedureStation™, 637
- QFD (quality function deployment), 158–160, 161
- Qualitative approaches
 - to decision making, 19
 - to forecasting, 80–81, 116
- Quality, defined, 379–380
- Quality at the source, 395
- Quality-based strategies, 52–53
- Quality circles, 382, 383, 407
- Quality control, 23, 380, 381, 418–463
 - cases, 462–463
 - defined, 419
 - inspections, 420–425
 - operations strategy and, 448
 - process capability, 443–448
 - purpose, 419
 - statistical process control (SPC). *See* Statistical process control (SPC)
- Quality differences, 61
- Quality function deployment (QFD), 158–160, 161
- Quality improvement, in lean operations, 619
- Quality Is Free* (Crosby), 382
- Quality management, 378–416
 - awards, 152, 381, 388, 391–392
 - benefits of quality, 388
 - cases, 414–416
 - compensation system and, 309
 - competitiveness and, 42
 - consequences of poor quality, 388–389
 - costs of quality, 382, 389–390
 - determinants of quality, 386–387
 - dimensions of quality, 383–385
 - ethics and, 390–391, 424
 - evolution, 380–381
 - foundations of modern, 381–383
 - for global operations, 354
 - for goods vs. services, 9, 10
 - graphical tools, 383, 401–408
 - in high-volume system scheduling, 696
 - ISO certification, 392–393, 672, 740
 - Kano model, 160–162
 - as key issue in operations, 27, 388
 - in lean operations, 612, 617
 - in operations strategy, 52–53, 409
 - process improvement. *See* Process improvement
 - quality, defined, 379–380
 - responsibility for quality, 387–388
 - in service organizations, 15, 167
 - supply chain and, 393–394
 - in supply chain management, 31
 - total quality management (TQM). *See* Total quality management (TQM)
 - at Wegmans Food Markets, Inc., 35
- Quality of conformance, 386, 425
- Quality of design, 386
- Quality of work life, 303, 305–310
- compensation, 308–310
- working conditions, 306–308
- Quality revolution, 24, 26
- Quality strategy, 46, 47, 54
- Quality tools, 401–408
 - benchmarking, 408
 - brainstorming, 407
 - in generating ideas, 382, 383, 407–408
 - graphical. *See* Graphical tools
 - quality circles, 382, 383, 407
- Quality transactions, 631
- Quality Without Tears* (Crosby), 382
- Quantitative approaches
 - to decision making, 19, 23
 - to forecasting, 80, 82–112, 116–117
 - to reliability measurement, 176–183
- Quantity discounts, 506, 520–525, 539
- Queue discipline, 792
- Queueing systems
 - finite-source situations, 789, 807–813
 - infinite-source situations, 789, 790, 793–807
- Queueing theory, 786
- Quick changeovers, in lean operations, 612
- Quick response
 - competitiveness and, 42
 - strategy based on, 50, 53, 54
- Radford, G. S., 380
- Radio frequency identification (RFID), 253, 448, 505, 509
 - active/semi-passive/passive, 681
 - defined, 678
 - in supply chain management, 661, 678–680, 681
- Rajamanickam, Vishnu, 684
- Random number table, 325–327
- Random variations
 - defined, 82, 425
 - in forecasting, 82, 83, 84
 - nature of, 14, 82
 - in statistical process control (SPC), 425, 426
 - as white noise, 84
- Range, as measure of process variability, 431
- Range control charts, 432–434
- Range of feasibility, 846
- Range of optimality (sensitivity analysis), 843
- Rate of technological change, 153
- Raw materials inventory, 505. *See also* Inventory management
 - in inspection decision, 422
 - in lean operations, 622
 - in location decisions, 358
- Reactive approach to forecasting, 112–113
- Recalibration, 320
- Recalls, product, 347, 614
- Receiving function, interface with purchasing, 667, 668
- Recycling, 69–70, 149–151, 174
- Reddy, Ram, 114–115
- Redundancy, 177
- Redundant constraints, 836–837
- Reed, John, 149, 149n
- Regenerative systems, 572–573
- Region identification, in location decisions, 358–359, 361
- Regression, 98–104
 - correlation/causal models, 102, 112
 - indicators, 101–102
 - least squares line, 98–99
 - multiple regression analysis, 102, 104
 - nonlinear, 104
 - regression equation, 103
 - simple linear regression, 80, 98–104
 - standard error of estimate, 100–101
- Regret (opportunity loss), 226
- Relationship management
 - customer, 664
 - in manufacturing planning and control, 629–630
 - supplier, 672–673
 - in supply chain management, 663–664, 672–673
- Reliability, 156–157, 176–189
 - as availability, 183–184
 - extended warranties, 181
 - in high-volume system scheduling, 696
 - improving, 156–157
 - under normal operating conditions, 156
 - quantifying, 176–183
 - requirements for, 156–157
- Relocation. *See also* Location planning and analysis
 - in strategic capacity planning, 207
- Remanufacturing, 148–149
- Reneging, 792
- Renewable resources, 150
- Reorder point (ROP), 525–530, 539
- Repetitive/assembly processing, 15. *See also* Learning curves
 - incentive systems, 309
 - in lean operations, 617–618
 - nature of, 247, 248, 249
 - product layout, 261–263
- Replacement, 650
- Requisition, 668
- Research and development (R&D), 143
- Reservation systems, 716
- Resiliency, 661–662
- Response time, in supply chain management, 686
- Responsiveness strategy, 44, 47
- Restaurant layouts, 270, 271
- Retailing
 - eliminating waiting lines, 787
 - facilities layout, 270–271
 - forecasting errors, 106
 - inspection points, 423
 - inventory management, 504. *See also* Inventory management
 - location planning and analysis, 15, 358–359, 363–364
 - part-time workers and, 472
 - point-of-sale (POS) systems, 508–509
 - quality and, 388
 - recycling at Maria's Market, 150–151
 - shoplifting prevention, 510
 - stock keeping units (SKUs), 509
 - universal product code (UPC), 508–509
- Return on investment (ROI), 504
 - for ERP, 585–586
 - supply chain, 658
- Return on quality (ROQ), 390
- Returns, 683–685
- Revenue management/yield management, 26, 485. *See also* Forecasting
- Reverse engineering, 142
- Reverse logistics, 683
- RFID (radio frequency identification). *See* Radio frequency identification (RFID)

- Right-sized equipment, 266
Rights Principle, 29
Risk
 decision making under, 224, 227
 defined, 224
 of global operations, 354, 358
Risk management
 as key issue in operations, 27
 in project management, 765–766
 in strategic capacity planning, 201
 in supply chain management, 659, 661–662, 665, 666, 686
Robotic systems, 57, 254, 255–259
Robust design, 157
Rolling planning horizon, 469, 572
Romig, H. G., 23, 24, 380
Roos, Daniel, 612
Rother, Mike, 633n
Rough-cut capacity planning (RCCP), 487
Run, defined, 438–439
Run charts, 406
Run tests, 438–442
 control charts with, 442
 formula summary, 450
 run, defined, 438–439
 runs above and below median, 439–442
Rush priority rule, 704, 705
Rwanda, drones in health care, 258

Safety
 ergonomics, 302, 305, 306, 312
 productivity and, 61
 in working conditions, 307–308
Safety stock, 525–529, 574–575
Salary. *See* Compensation
Salegna, Gary, 397n
Sales and operations planning, 466. *See also*
 Aggregate planning
Salesforce opinions, 81
Sales function
 operations management and, 582
 in supply chain management, 663
Sample size, in statistical process control (SPC), 438
Sampling, 23
 acceptance, 419, 420
 work, 323–327, 328, 329
Sampling distribution, 425–426
Sampling variability, 444
Santa Clara University, Markula Center for
 Applied Ethics, 29–30
Scale-based strategies, 46
Scatter diagrams, 402, 404, 405
Schedule chart, 700
Scheduled receipts, in MRP, 567
Scheduling, 691–731
 challenges of, 713–714
 in decision-making hierarchy, 693–694
 defined, 693
 for goods vs. services, 9
 high-volume system, 694–696
 importance, 694
 intermediate-volume, 696–697
 low-volume. *See* Job-shop scheduling
 multiple resources, 718–719
 operations strategy, 719
 in project management, 739
 in service organizations, 15, 715–719
 theory of constraints, 715

Schematic models, 18
Schiff, Jennifer Lonoff, 587–589
Schonberger, Richard J., 620n
Schrage, Eli, 207
Scientific management, 21–23, 24, 302, 305, 311, 380
SCOR® (Supply Chain Operations Reference)
 model, 682
Scrap and scrap rates, 61, 67
Seasonality
 in aggregate planning, 465–466, 468, 472, 473
 defined, 82
 in forecasting, 82, 83, 93–98, 112, 198–199
 seasonal inventories, 505
 in strategic capacity planning, 198–199, 204–205
Seasonal relatives, 94–98
 computing, 96–98
 using, 95
Seasonal variations, 93–94
Secondary reports, in MRP, 573–574
Security, global operations and, 353
Self-directed teams, 304
Self-driving (autonomous) vehicles, 259
Sensitivity analysis, 230–232, 843–846
Sequencing, 704–713
 Johnson's rule, 711–713
 priority rules, 704–710
 setup times independent of processing order, 711–713
 setup times sequence-dependent, 713
 through two work centers, 711–713
Sequential relationships, network diagram, 743–744
Serviceability
 defined, 141
 in service design, 141
Service blueprint, 168
Service delivery system, 166
Service design and development, 165–170. *See also* Product/service design
 challenges, 169
 characteristics of well-designed service systems, 168–169
 guidelines, 169–170
 overview, 166
 phases, 167
 product design vs., 166–167, 169
 quality considerations, 384–385, 386, 387, 419, 423, 448. *See also* Quality management
 service blueprinting, 168
 technology in, 25
Service layouts, 15, 263–264, 268–272
Service level, 526, 534–535, 536
Service package, 166
Service patterns, 790–792
Service profiling, 251–252
Service quality
 competitiveness and, 43
 perceived, 167
 strategy based on, 45, 47
Service rate, 795
Services/service organizations
 aggregate planning, 484–485
 automation, 270, 271–272
 capacity planning, 14, 167, 200–201, 484–485

challenges of managing services, 169
competitiveness and, 43
ERP in, 587
facilities layout, 15, 263–264, 268–272
flow management, 656
in goods-service continuum, 7
importance of service sector, 17
in-house vs. outsourcing, 201–202
as internal factor, 49
inventory management in, 15, 504
lean systems, 637–638
location planning and analysis in, 9, 15, 363–364
MRP in, 576
operations management and, 14–15
process variation and, 14
productivity in service sector, 59–60
providing, vs. production of goods, 8–10
quality assurance, 15, 167
scheduling, 15, 715–719
service job categories, 8
services, defined, 4, 166
supply chains for, 4–6, 656, 657
transformation processes, 6–8
variability in demand, 199
waiting-line analysis. *See* Waiting-line management
Service strategy, 45, 46
SERVQUAL, 385
Setup costs, 510
 in intermediate-volume system scheduling, 696–697
 in lean operations, 618–619, 638
Setup times
 in lean operations, 618–619
 sequence-dependent, 713
 sequence-independent, 711–713
Shadow price, 844–845
Shewhart, Walter, 23, 24, 381, 383, 428
Shewhart cycle, 398–399
Shih, Willy, 17, 17n
Shingo, Shigeo, 24, 382, 383, 611, 618, 622
Shook, John, 633n
Shoplifting prevention, 510
Shortage costs, 510, 533
Shortest processing time (SPT) priority rule, 704, 706–707, 709
Short-range planning, in perspective, 466–467
Short-term capacity, 198
Short-term forecasting, 76
Shutdown, as location option, 352
Simchi-Levi, David, 670n
Simchi-Levi, Edith, 670n
Simo chart, 316, 317
Simple average (SA) method, 96–98
Simple linear regression, 80, 98–104
Simplex method, 840
Simulation models, 199, 482
 in aggregate planning, 482–483
 of path duration times, 758–759
 in strategic capacity planning, 212
Simultaneous development, 163
Single-minute exchange of die (SMED), 266, 618
Single-period model, 533–537, 539
 continuous stocking levels, 534–535
 discrete stocking levels, 535–537
Single server
 constant service time, 793, 796–797
 exponential service time, 793, 795–796

- Sintering, 257
- Site identification, in location decision, 360–361
- Six Sigma, 161, 446
defined, 26, 400
lean operations and, 634
- Skill levels, aggregate planning and, 471
- Skinner, W., 24
- Slack (linear programming), 839–840
- Slack per operation (S/O) priority rule, 704, 710
- Slack time, 744, 745–746
aggregate planning and, 472
computing, 752–753
- Slater, Derek, 583–587
- Small Business Administration, 665
- Small businesses
“Cocoa for Good” initiative, 28
inventory management and, 664–665
supply chain management and, 664–665, 679, 686
- Small lot sizes, in lean operations, 612, 617–618
- SMED (single-minute exchange of die), 266, 618
- Smith, Adam, 23, 24
- Smith, Bernard T., 88–89, 89n
- Smoothing
in inventory management, 505
in strategic capacity planning, 204
- Social conditions, in product/service design, 141
- S/O (slack per operation) priority rule, 704, 710
- Souza, Kim, 660n
- Sower, Victor E., 731
- SPC. *See* Statistical process control (SPC)
- Specialization
advantages/disadvantages, 302–303
defined, 302
in job design, 302–303
as strategy, 46
- Special variation, 425
- Specifications
defined, 443
process capability and, 443, 444, 446–447
- Spencer, Lisa F., 28, 149, 181, 258, 355, 510, 513, 635, 660, 661, 679, 684, 740, 787
- SPT (shortest processing time) priority rule, 704, 706–707, 709
- Standard deviation, 14
process capability, 445
run test, 440–442
- Standard elemental times, 322–323
- Standard error of estimate, 100–101
- Standardization, 22, 61, 170, 196
advantages/disadvantages, 153–154
automation in, 253
defined, 153
degree of, 153
modular design, 155–156
service, 167
standard parts in lean operations, 617
in waiting-line management, 813
- Standard time, 316
- Starting forecasts, 88
- Stashick, Randy, 311, 311n, 679n
- Statistical process control (SPC), 419, 425–443.
See also Quality control
attributes, 434–437, 438
control charts, 428–438, 442
control limits, 428–429, 430–431, 434–437
control process, 427
defined, 425
nonrandom (assignable) variation and, 14, 425, 439, 441–442, 443
process variability, 425
random variation (common variability) and, 425, 426
run tests, 438–442
sampling and sampling distributions, 425–426
Type I/Type II error, 429, 443
for variables, 430–434
- Step costs, 210
- Stickley, George, 606
- Stickley, Leopold, 606
- Stock keeping units (SKUs), 509, 679
- Stockouts, 506
- Stopwatch time study, 317–322
allowances, 321, 322
defined, 318
formula summary, 329
normal time (NT), 319, 320
number of observations needed, 318–319
observed time (OT), 319
standard time (ST), 319, 320–321
work sampling vs., 328
- Storage facility layout, 270
- Straight piecework, 309
- Strategic buffering, 674–675
- Strategic capacity planning, 190–221
case, 221
constraint management, 207
cost-volume analysis, 208–211
decision theory, 212
defining and measuring capacity, 191, 194–195
determinants of effective capacity, 196–197
developing capacity strategies, 202–206
evaluating alternatives, 207–212
financial analysis, 211–212
forecasting capacity requirements, 192, 198–200
goal of, 192, 466
importance, 191–193, 200
importance of capacity decisions, 193–194
in-house vs. outsourcing, 201–202
key questions, 192
location decisions, 196
operations strategy and, 213
outsourcing in, 201–202, 205–206, 221
for services, 200–201
simulation, 212
steps in process, 198
strategy formulation, 197–198
time horizons, 198–199, 200, 204–205
waiting-line analysis, 212
- Strategic decisions, 33
critical importance, 13–14, 193–194, 200, 213
developing capacity strategies, 202–206
strategic operations management decision areas, 52, 53
strategy formulation, 197–198
- Strategic partnering, 666, 673–674
- Strategic sourcing, 681–682
- Strategies, 16, 44–56
cases, 67–70
examples of, 44, 46
formulating, 47–50
global, 51
nature of, 41
- Profit Impact of Market Strategy (PIMS)
database, 49–50
strategy formulation, 47–50, 52–53
supply chain, 50, 665, 666
sustainability, 50–51
types of, 45
- Sturcken, Elizabeth, 660n
- Subcontracting, 201–202, 205. *See also* Outsourcing
in aggregate planning, 465, 467, 469, 473, 474, 476–480
- Subject-matter experts (SMEs), 115
- Suboptimization, 224
- Substitutability of parts, 165
- Subtractive manufacturing, 257
- Summers, Donna, 399n
- Supplier forums, 672–673
- Suppliers
as adversary vs. partner, 673
audits of, 671–672
certification of, 672
close vendor relationships, 629–630
as external factor, 49
interface with purchasing, 667
in lean operations, 629–631, 636, 639
multiple-source purchasing and, 630
partnerships with, 666, 673–674
placing orders with, 668
in product/service design, 143
in quality management, 395
selecting, 668, 671, 672
in strategic capacity planning, 203
supplier relationship management, 672–673
supplier tiers, 630–631
in supply chain management, 32, 662, 663, 667, 668, 672–673, 678
vendor-managed inventory (VMI), 638, 675, 677
- Supply. *See also* Strategic capacity planning
in aggregate planning, 468–469, 471–476, 492
economic match with demand, 4, 76
- Supply chain(s)
aggregate planning and, 470
complexity of, 32
defined, 4, 656
distribution resource planning (DRP), 580–581
ethics and, 664
examples of, 5–6, 657, 658
external/internal parts of, 6
global, 663
inventory buffers in, 506
lean operations and, 634
location criteria, 351
nature of, 4–6
process variation and, 14
shortening, 662
in strategic capacity planning, 197
strategies in, 665, 666
strategy based on, 50
- Supply chain management, 654–690
capacity planning, 32, 666
case, 689
challenges, 685–686
competitiveness and, 31, 43
defined, 656
e-business in, 32, 670–671
elements of, 32–33

- Supply chain management—*Cont.*
 ERP and, 663–664
 ethics and, 664, 673
 flow management in, 656–657
 forecasting in, 32, 79, 114–115, 674, 678. *See also* Forecasting
 for global operations, 31–32, 659, 663, 665
 for goods vs. services, 8
 importance, 31–32, 666, 686
 inventory management in, 32, 33, 538, 664–665, 674–675. *See also* Inventory management
 location planning and analysis in, 32, 33, 351
 logistics in, 32, 656, 676–681
 management responsibilities, 665–666, 685
 operations management and, 15–17, 582
 outsourcing, 31, 33, 658–659, 663
 performance metrics, 682
 purchasing/procurement, 32, 33, 667–669, 681–682
 quality and, 31, 393–394
 returns in, 683–685
 risk management in, 659, 661–662, 665, 666, 686
 small businesses and, 664–665, 679, 686
 strategic sourcing, 681–682
 strategies in, 50, 665, 666
 supplier management, 671–674
 at 3M, 662
 trends, 657–662
 at Walmart, 660
 at Wegmans Food Markets, Inc., 655
 Supply chain visibility, 662
 Supporting processes, 13
 Surplus (linear programming), 839–840
 Sustainability, 27–29. *See also* Environmental concerns
 at Kraft Foods, 147, 148
 in process selection, 252
 in product/service design, 146–151
 reduce/reuse/recycle, 147–151
 strategy based on, 46, 50–51, 54, 69–70, 71–72
 at U.S. Postal Service (USPS), 72–73
 at Wegmans Food Markets, Inc., 35
 SWOT analysis, 48
 System, 20
 System design, 16
 in facilities layout, 260. *See also* Facilities layout
 in process selection, 246
 in strategic capacity planning, 203, 246
 System operation, 16
 Systems perspective, 20
 System utilization, 794
 Tactical decisions, 16, 44
 Tactics, 45, 666
 Taguchi, Genichi, 157, 382, 383, 447
 Taguchi loss function, 382, 383, 447, 448
Takt time, 620–621
 Tangible output, 8
 Tardiness, 705
 Tariffs, 32
 Taxation, in location decisions, 359
 Taylor, Frederick Winslow, 21–23, 24, 302, 305, 311, 317, 380
 Teamwork
 cooperative spirit in conversion to lean systems, 636–637
 forms of teams, 304
 group incentive plans, 309–310
 in job design, 303–305
 in lean operations, 612, 623–624, 636–637
 project teams, 737, 739, 763–764
 in quality focus, 26
 in quality management, 395
 requirements for successful, 305
 Technological innovation, 25, 252
 Technology. *See also* Computer software
 agility and, 26
 automation and, 253–257, 354–355
 cashierless retailing, 787
 computer-aided design (CAD), 164–165, 170
 computer-aided manufacturing (CAM), 254–255
 computer-integrated manufacturing (CIM), 256–257
 computerized numerical control (CNC), 254–255
 defined, 25, 252
 Delphi method in technological forecasting, 81
 drones, 258, 259, 513
 end-of-life (EOL) programs, 147
 enterprise resource planning (ERP). *See* Enterprise resource planning (ERP)
 as external factor, 48
 global operations and, 352, 354–355
 as internal factor, 49
 job design and, 311
 management of, 25
 modular design, 155–156
 MRP. *See* Material requirements planning (MRP)
 process selection and, 252–259
 productivity and, 60–61
 product/service design and, 141, 142–144
 rate of technological change, 153
 robotic systems, 57, 254, 255–259
 in supply chain management, 659–661, 666, 678–680, 681
 technological change strategy, 48
 technological constraints in line balancing, 276
 3D printing, 257–259
 types of, 25
 at Wegmans Food Markets, Inc., 35
 Temporary workers, 813
 Termination, in project management, 738
 Terrorism, 354
 Theory of constraints, 715, 763
 Theory X, 23
 Theory Y, 23
 Theory Z, 23
 Therbligs, 315–316
 Third-party logistics (3-PL), 681
 3D printing, 257–259
 3D scanning, 258
 Throughput, 715
 Time-based competition, 467
 Time-based strategies, 53
 Time-based systems, 308–309, 310
 Time buckets, 566
 Time estimates
 deterministic, 745–746
 probabilistic, 745, 753–755
 Time fences, 488, 579
 Time horizons
 in forecasting, 76–79, 111–112, 113, 198–199
 probability of functioning for specified time period, 178–183
 in strategic capacity planning, 198–199, 200, 204–205
 Time reduction, 26
 Time series, 82
 Time-series forecasts, 80, 82–98
 averaging techniques, 84–88
 cycles, 82, 83, 98
 diffusion models, 89
 focus forecasting, 88–89
 irregular variations, 82, 83
 naive forecasts, 82–83
 random variations, 82, 83
 seasonality, 82, 83, 93–98
 trends, 82, 83, 89–93
 Time-to-market, competitiveness and, 42
 Time value of money, 211–212
 Tippett, L. H. C., 23, 24
 Top management
 country identification for global operations, 357–358
 executive opinions, 80
 quality and, 381–382, 387, 391, 409
 in supply chain management, 665–666, 673–674, 685
 transition to lean operations, 635, 636, 639
 upper-management processes, 13
 Total cost
 in cost-volume analysis, 208–211
 economic order quantity (EOQ), 516–518
 Total field, 382, 383
 Total productive maintenance, 649
 Total quality management (TQM), 26, 394–408
 criticisms, 397
 elements of, 395
 graphical quality tools, 401–408
 obstacles to implementing, 396–397
 process improvement, 398–408
 traditional corporate culture vs., 396
 Total revenue, in cost-volume analysis, 208–211
 Toyoda, Eliji, 614
 Toyota Production System (TPS), 611, 612, 613–615, 635
 TQM. *See* Total quality management (TQM)
 Tracking capacity strategy, 198
 Tracking signals, 109–111
 Trade agreements, 352
 Trade-offs
 cost/accuracy, in forecasting, 111–112
 in decision making, 19–20
 in resource allocation, 26
 Trade wars, 32
 Traffic management, 678
 Training
 cross-training workers, 280, 623
 learning curves, 336–337
 Transaction processing
 in lean operations, 631
 transaction types, 631
 Transfer batch, 715
 Transfer pricing rules, 358

- Transformation processes, 6–8, 13–14
- Transparency, in supply chain management, 661
- Transportation costs
 - in location decision, 350, 353, 356–357, 358–359, 363, 366
 - minimizing, 282–283
 - process layouts, 282–283
 - in supply chain management, 31, 33
 - unnecessary, in lean operations, 616
- Transportation model, 366
- Transportation tables, 481–482, 483
- Travel and tourism. *See also* Airlines
 - duplicate bookings, 469, 470
 - reservation systems, 716
 - revenue/yield management, 26
- Trend-adjusted exponential smoothing, 92–93, 112
- Trend-adjusted forecasts (TAF), 112
- Trends
 - in compensation, 310
 - defined, 82
 - in forecasting, 82, 83, 89–93, 112
 - linear trend equation, 89–92
 - nature of, 82
 - nonlinear trend types, 89
 - in supply chain management, 657–662
- Trial-and-error aggregate planning, 476–480
- Two-bin system, 508
- Type I error, 429, 443
- Type II error, 429

- Uncertainty, decision making under, 224, 225–227
- Understocking costs, 506–507, 526–527
- Uniform Commercial Code, 144
- Uniform distribution, in forecasting demand, 199
- Union contracts, aggregate planning and, 471–472, 474–475
- Union of Japanese Scientists, 381
- United Kingdom (UK), shoplifting prevention, 510
- United Nations Food and Agricultural Organization (FAO), 29
- U.S. Army, 380
- U.S. Consumer Product Safety Commission (CPSC), 393
- U.S. Department of Education, 44
- U.S. Small Business Administration, 665
- Universal product code (UPC), 508–509
- Upper control limit (UCL), 428–429, 430–431, 435–437
- Upper-management processes, 13
- U-shaped layouts, 263
- Utilitarian Principle, 29

- Value-added
 - defined, 6
 - manufacturing process, 17
 - transformation process, 6
 - waiting lines as non-value-added occurrences, 785–786
- Value analysis, 147–148
- Value chain(s)
 - demand component, 656
 - supply component. *See* Supply chain(s); Supply chain management
- Value stream, operational processes in, 13
- Value stream mapping, 632–633
- Variable costs, in cost-volume analysis, 208–211
- Variable-path material-handling equipment, 263–264
- Variables
 - control charts for, 430–434, 438
 - defined, 430
- Variety strategy, 47, 54
- Vendor analysis, 671
- Vendor-managed inventory (VMI), 638, 675, 677
- Vendors. *See* Suppliers
- Vertical loading, 303
- Vertical skills, 310
- Virtual project teams, 763–764
- Virtual teams, 146
- Virtue Principle, 29
- Visual controls, in lean operations, 612, 627–628
- VMI (vendor-managed inventory), 638, 675, 677
- Vollmann, Thomas E., 615n, 631, 631n

- Wages. *See* Compensation
- Wait-and-see strategy, 213
- Waiting-line management, 784–822
 - analysis, 167
 - in capacity planning, 199
 - case, 822
 - characteristics of waiting lines, 789–792
 - constraint management, 813
 - cost analysis, 801–803
 - finite-source situations, 789, 807–813
 - goal of, 788
 - infinite-source situations, 789, 790, 793–807
 - managerial implications of waiting lines, 787
 - nature of, 785–786
 - operations strategy, 814–815
 - performance metrics, 792–793
 - psychology of waiting, 813–814
 - queuing theory, 786
 - reasons for, 786–787
 - in strategic capacity planning, 212
 - technology in, 787
 - waiting time as waste in lean operations, 616
 - at Walt Disney theme parks, 785, 815
- Walton, Sam, 660
- Warehouses
 - facilities layout, 270
 - inventory management, 513
 - in supply chain management, 677–678
- Waste reduction, in lean operations, 612, 613, 615–616, 633, 638
- Water pollution
 - nonvegetarian diets and, 29
 - recycling and, 149
- Wealth of Nations, The* (Smith), 23
- Weather forecasts, 14, 75, 82, 93, 113
- Weber, Austin, 635n
- Wei, Clarissa, 386n
- Weighted average, 86–87
- Weighted moving average, 86–87
- Wheeler, John, 284n
- White noise, 84
- Whitney, Eli, 22, 24
- Whybark, D. Clay, 615n
- Williams, Terri, 181, 181n
- Wilson, J. Holton, 112n
- Winebrake, James J., 658n
- Wolverson, Roya, 26n
- Womack, James, 612
- Work breakdown structure (WBS), 741
- Work breaks, 307
- Work cells, in lean operations, 612, 619
- Work centers
 - input/output (I/O) control, 700
 - sequencing work through, 704–713
 - workstations within, 279–280, 704
- Work design and measurement
 - job design. *See* Job design
 - methods analysis, 310–314
 - motion study, 305, 315–316
 - operations strategy and, 327–328
 - quality of work life, 305–310
 - work measurement, 316–327
- Worker-machine charts, 313, 314
- Workers. *See* Workforce
- Workforce. *See also* Personnel/human resources
 - function
 - in aggregate planning, 471–472, 474–475, 485
 - compensation, 308–310
 - competitiveness and, 43
 - empowering, 395, 407
 - impact of outsourcing on, 17
 - labor productivity, 58, 61, 353, 354, 358, 359
 - in lean operations, 622–624
 - learning curves in scheduling, 340
 - in location decisions, 358, 359
 - motivating, 15
 - overtime work, 205, 472
 - productivity and, 60–61
 - quality circles, 382, 383, 407
 - quality of work life, 303, 305–310
 - scheduling, 717
 - service job categories, 8
 - shift demand, 813
 - temporary workers, 813
 - training, 15, 280, 336, 337, 623
 - unemployment benefits, 17
 - unions and, 471–472, 474–475
 - at Wegmans Food Markets, Inc., 35
 - working conditions, 306–308
 - Working conditions, 306–308
 - Work-in-process inventory, 505. *See also* Inventory management
 - constant work-in-process (CONWIP), 629
 - kanban, 629
 - in lean operations, 621–622, 629, 638
 - Little's Law, 506, 629
- Work measurement, 316–327
 - predetermined time standards, 323
 - standard elemental times, 322–323
 - standard time, 316
 - stopwatch time study, 317–322, 328, 329
 - work sampling, 323–327, 328, 329
- Work sampling, 323–327
 - formula summary, 329
 - random number table, 325–327
 - sample size, 324–325
 - stopwatch time study vs., 328
- Workstations, 279–280, 704
- World Bank, 358
- World Trade Organization, 352
- World War II, 23, 380, 381

- Yield management, 77, 716–717
- Yield management/revenue management, 26, 485. *See also* Forecasting

- Zeithaml, Valerie A., 384n, 385n
- Zero defects, 380, 382, 383

